

# Multi-family Price Book 11

Effective February 19, 2022 • Rev. 02/22



# Where residential and commercial lever styles meet

Schlage, Falcon, and Von Duprin locks and exit lever designs allow for residential and common areas to match in style, whether that is contemporary, to transitional, to traditional. While the lever and trim names may differ between the various series below, you can have confidence that each lever design will coordinate into one of the lever suiting styles. Coordinate the lever designs below to create seamless transitions between residential and commercial areas.

## Contemporary

Minimalist lever design with clean lines



Latitude, Longitude, Solstice

## Contemporary/Transitional

Rounded, high-style lever design



Broadway, Boardwalk, M52

## Transitional/Traditional

Curved, tapered lever design



Jazz, Jupiter, Athens, Dover, Avalon, 07

Quantum, Sparta, Neptune, 17

## Traditional

Simplistic return-to-door lever design



Rhodes, Saturn, Marin, Elan, Dane, 06

	Contemporary	Contemporary / Transitional	Transitional / Traditional	Traditional	
<b>Residential area locks</b>					
Schlage Control Smart Interconnected Lock - Grade 2	Latitude	Broadway	Jupiter, Jazz	Neptune	Elan
Schlage F Series cylindrical lock - Grade 2	Latitude	Broadway	Jazz	Jazz	Elan
Schlage J Series lock - Grade 3	Solstice	-	Dover	Dover	Marin
<b>Common area locks</b>					
Schlage LE mortise wireless lock - Grade 1	Latitude	M52	07	17	06
Schlage L Series mortise lock - Grade 1	Latitude	M52	07	17	06
Schlage NDE cylindrical wireless lock - Grade 1	Latitude	Broadway	Athens	Sparta	Rhodes
Schlage ND Series cylindrical lock - Grade 1	Latitude	Broadway	Athens	Sparta	Rhodes
Schlage CS210 interconnected lock - Grade 2	Latitude	Broadway	Jupiter	Neptune	Saturn
Falcon MA Series mortise lock - Grade 1	Latitude	Broadway	Avalon	Quantum	Dane
Falcon T Series cylindrical lock - Grade 1	Latitude	Broadway	Avalon	Quantum	Dane
Falcon W Series cylindrical lock - Grade 2	Latitude	Broadway	Avalon	Quantum	Dane
Falcon H2 Series interconnected lock - Grade 2	Latitude	Broadway	Avalon	Quantum	Dane
<b>Commercial exit devices and trim</b>					
Von Duprin 98/99 Series wide stile pushpad - Grade 1	Latitude	M52	07	17	06
Falcon 25 Series wide stile pushpad - Grade 1	Latitude	Broadway	Avalon	Quantum	Dane
Falcon 24 Series narrow stile pushpad - Grade 1	Latitude	Broadway	Avalon	Quantum	Dane

Note: Not all levers and trim are listed for the products mentioned in this price book. For the complete offering, contact your sales consultant.

## Contents

### Locks

#### Residential Electronic Locks

Schlage Control FE410 Smart Interconnected Locks - Grade 2.....	4-5
Schlage Control BE467 Smart Deadbolts - Grade 2.....	6-7
Schlage Control Multi-Family Residential Electronic Locks - Top Sellers.....	8

#### Residential Mechanical Locks

Schlage F Series - Grade 1.....	9
Schlage J Series - Grade 3.....	10-11
B and J Series Deadbolts.....	12-17
Schlage LE Mortise Wireless Locks - Grade 1.....	18-19

#### Commercial Wireless Electronic/Electrified Locks, Readers and Devices

Schlage LE Mortise Wireless Locks - Grade 1.....	20-23
Schlage NDE Cylindrical Wireless Locks - Grade 1.....	25-27
Schlage CTE Single Door Controller.....	28
Schlage Electromagnetic Locks.....	29
Schlage MTB Series Wall Mount Readers.....	30

#### Commercial Mechanical and Electrified Locks - Schlage and Falcon

Schlage B500 - Single Cylinder Deadbolt Series.....	31
Schlage CS210 Interconnect Lock - Grade 2.....	31-32
Schlage L Series Mortise Locks - Grade 1.....	33-42
Schlage ND Series Cylindrical Locks - Grade 1.....	43-48
Falcon MA Series Grade 1 Mortise Lock.....	49-52
Falcon T Series Grade 1 Cylindrical Lock.....	53-55
Falcon W Series Grade 1 Cylindrical Lock.....	56-59
Falcon D200 Grade 2 Medium Duty Deadbolt.....	60-62
Falcon H2 Series Grade 2 Interconnected Lock.....	63-64
Falcon Cylinders.....	65
Falcon Conventional Cylinders.....	66
Falcon Interchangeable Cores.....	67
Falcon IC Cylinders.....	67
Falcon Conventional Keys and Blanks.....	68
IC Keys and Key Blanks, Disposable Construction Core.....	69
Falcon Keys & Keying Construction Core Program.....	70

### Exits

#### Von Duprin

Von Duprin 22 Series.....	71
Von Duprin 22 Series Trim.....	72
Von Duprin Auxiliary Parts.....	73
Von Duprin Electronics e-Strike.....	74
Von Duprin 98 Series.....	75
Von Duprin Device Options.....	76
Von Duprin Device Accessories.....	77
Von Duprin Dummy Touch Bars.....	77

#### Falcon

Falcon 24 Series.....	78-83
Falcon 25 Series.....	84-89
Falcon 19 Series.....	90-95
Falcon 1690 Series.....	96
Falcon 1790 Series.....	97
Falcon 1990 Series.....	98
Falcon 2090 Series.....	99

### Policies and documents

The purchase of Allegion products is governed by the Allegion Authorized Seller Program. For program terms and conditions, and other program details, please visit: [www.allegion.com/AuthorizedSeller](http://www.allegion.com/AuthorizedSeller).

For Warranty information, visit [us.allegion.com/warranty](http://us.allegion.com/warranty) or contact Customer Service at 877-671-7011.

### Door Closers

#### LCN

LCN 1250 Series Surface Door Closers.....	100
LCN 1260 Series Surface Door Closers.....	100
LCN 1450 Series Surface Door Closers.....	100
LCN 1460 Series Surface Door Closers.....	101
LCN 4040XP Series Surface Door Closers.....	101
LCN 4050A Series Surface Door Closers.....	101
LCN Parts and Components.....	102
Automatic Operators.....	103

#### Falcon

Falcon Surface Door Closers.....	104-105
Falcon SC60A Series.....	106
Falcon SC70A Series.....	107
Falcon SC80A Series.....	108
Falcon SC90A Series.....	109

### Architectural Hardware

#### Ives

Architectural Hinges.....	110
Continuous Hinges.....	110
Pivots.....	111
Floor Stops.....	112
Wall Stops.....	113
Pulls and Protection Plates.....	114
Vandal Resistant Trim.....	115
Flush Bolts and Strikes.....	115
Coordinators, Lock Guards, and Surface Bolts.....	116
Latches and Catches.....	117
Miscellaneous Hardware.....	118

#### Schlage

Schlage Barn Door Hardware.....	119-120
---------------------------------	---------

### Overhead Holders and Stops

#### Glynn-Johnson

70 Series Heavy Duty Surface Mount.....	121
81 Series Heavy Duty Surface Mount.....	121
90 Series Heavy Duty Surface Mount.....	121
100 Series Heavy Duty Concealed Mount.....	122
410 Series Medium Duty Concealed Mount.....	122
450 Series Medium Duty Surface Mount.....	122

### How to Order

#### Locks

Schlage Residential.....	124
Schlage Commercial.....	125

#### Commercial Wireless Electronic/Electrified Locks, Readers and Devices

Schlage LE Series.....	126-127
Schlage NDE.....	128-129
Schlage CTE Series.....	130

#### Commercial Mechanical Locks

Schlage ND Series.....	131
Schlage L Series.....	132
Schlage AL Series.....	133

#### Exits

Von Duprin Exits.....	134
Falcon Exits.....	135
Falcon Trim.....	136

#### Closers

LCN.....	137
Falcon.....	138-140

#### Accessories

Glynn-Johnson.....	141
--------------------	-----

Schlage Control™ Mobile Enabled Smart Interconnect Locks



FE410 with Greenwich trim with Broadway Lever



FE410 with Addison trim with Accent lever

Standard Features

- Keyless, no cylinder design — 100% bump and pick-proof
- Modern credentials — smart credential and/or phone as key
- Wireless freedom — control and program by phone
- Up to 500 users per lock
- Audit trail reports up to 1,000 events
- Fits standard door prep
- 1 year battery life with BLE mobile credential capability enabled.
- 1.5 year battery life without BLE mobile credential capability enabled.
- Full suiting with Schlage mechanical locks
- Single motion egress
- ADA compliant design
- Uses ENGAGE™ Technology
- See page 8 for information on the MT20W Credential Enrollment Reader



Specifications

<b>Latch:</b>	1" x 2 1/4" square and round corner faceplate (square corner standard, round corner included in package) 1" edge bore required	<b>Credentials:</b>	Supports Schlage MIFARE Classic®, Schlage MIFARE Plus®, Schlage DESFire® EV1 (sold separately), Schlage Mobile Access Credential. Please refer to the Credential Section of the Allegion Electronic Security Price Book.
<b>Strikes:</b>	1 1/8" x 2 3/4", square corner, no box, latch strike	<b>Stile Width:</b>	Minimum 4 1/2" stile for 2 3/8" backset, minimum 5" stile for 2 3/4"
<b>Backset:</b>	Adjustable backset, fits 2-3/8" to 2 3/4" backsets	<b>Return to Door:</b>	Saturn (SAT), Neptune (NEP), Boardwalk (BRK) and Longitude (LON) are return to door code compliant
<b>Door Range:</b>	1 3/4" (thick door kit available - up 2")	<b>Center to Center:</b>	Fits 4" or 5 1/2" center to center door preps -orderable options (Please specify when ordering)
<b>Battery:</b>	4-AA batteries included, (If loss of battery power occurs, a 9V battery can be used to jump start the lock and provide access with an assigned credential.)	<b>Certifications:</b>	90-minute UL Listed A 156.36 Grade 2 ANSI/BHMA certified; Canada UL 20-minute wood door rated. Approved for use where the exterior escutcheon only is exposed to the outdoors.
<b>Construction:</b>	All-metal chassis and escutcheons		
<b>Bore:</b>	2 1/8"		

FINISH CODES & DESCRIPTIONS\*

<b>619</b>	<b>622</b>	<b>625</b>	<b>626</b>	<b>716</b>
Satin Nickel (US15)	Matte Black (US19)	Bright Chrome (US26)	Satin Chrome (US26D)	Aged Bronze (643e)

\* Non-Standard finishes are not available. Available in split finish and/or split lever options for no additional charge.

1. Select Lock Model

Part No.	Description	Price (ea.)
FE410F	Schlage Control Mobile Enabled Smart Interconnect, UL Listed, 90 minutes	\$741.00

2. Select Design Style

Style/Description	Price (ea.)
(ADD) Addison	n/c
(GRW) Greenwich	n/c

3. Select Interconnect Type

Style	Description	Price (ea.)
4"	For doors with 4" bore hole spacing (40)	n/c
5-1/2"	For doors with 5 1/2" bore hole spacing (55)	n/c

**4. Design - Select Lever Style And Finish**

Style / Description	619 - Satin Nickel	622 - Matte Black	625 - Bright Chrome	626 - Satin Chrome	716 - Aged Bronze
ACC / Accent	n/c	n/c	n/c	n/c	n/c
VLA / Avila	n/c	Not Available	n/c	n/c	n/c
BIR / Birmingham	n/c	Not Available	n/c	Not Available	n/c
BRW / Broadway	n/c	n/c	n/c	n/c	n/c
BRK / Boardwalk	n/c	n/c	n/c	n/c	n/c
ELA / Elan	n/c	n/c	n/c	n/c	n/c
JAZ / Jazz	n/c	n/c	n/c	n/c	n/c
JUP / Jupiter	n/c	n/c	n/c	n/c	n/c
LAT / Latitude	n/c	n/c	n/c	n/c	n/c
LON / Longitude	n/c	n/c	n/c	n/c	n/c
MNH / Manhattan	n/c	Not Available	n/c	n/c	Not Available
NEP / Neptune	n/c	n/c	n/c	n/c	n/c
NBK / Northbrook	n/c	Not Available	Not Available	Not Available	Not Available
SAC / Sacramento	n/c	Not Available	n/c	n/c	n/c
SAT / Saturn	n/c	n/c	n/c	n/c	n/c

**Latch**

Part No.	Description	Price (ea.)
12-356	Combo latch, Dual option (sq + rd), Non UL bolt, UL latch - STANDARD	Not Sold Separately

**Handing**

	Description	Price (ea.)
Left	STANDARD - Can be changed to Right handed in the field	n/c

**Deco Trim**

Part No.	Description	Price (ea.)
06-219	STANDARD - ADD or GRW depending on which style is selected above	n/c

**Strike Combinations**

Part No.	Description	Price (ea.)
10-152	STANDARD - Combo Strike, Square Corner (10-094 & 10-026)	n/c
10-151	10-094 & 10-001	n/c
10-119	10-081 & 10-001	n/c
10-122	10-116 & 10-027	n/c
10-123	10-092 & 10-027	n/c
10-124	10-095 & 10-027	n/c

**Deadbolt Strike Options**

Part No.	Description	Price (ea.)
10-094	Square Corner Strike, 1 1/8" x 2 3/4" - STANDARD	14.00
10-092	1/4" Radius round corner, full lip, no box, 1 5/8" x 2 1/4"	9.00
10-095	Square corner, full lip, no box, 1 5/8" x 2 1/4"	9.00
10-112	Metal dust box with screws	13.90

**Deadlatch Strike Options**

Part No.	Description	Price (ea.)
10-026	Square corner, full lip, no box, 1 5/8" x 2 1/4" - STANDARD	8.70
10-001	Square corner, T-strike, box, 1 1/8" x 2 3/4"	7.50
10-027	1/4" Radius round corner, full lip, no box, 1 5/8" x 2 1/4"	8.70

**Thick Door Kit**

Part No.	Description	Price (ea.)
47244555	For doors between 1 3/4" and 2"	\$25.60

The Schlage Control Interconnect Lock uses the same Thick Door Kit as the Deadbolt. However, due to the latch assembly it should only be used on doors between 1 3/4" and 2".

**Screw Packs**

Part No.	Description	Price (ea.)
47250323	Security Screws - Optional Security torx screws	\$7.40
47244558	FE410 screw pack	7.40

For Screw Packs, specify finish option (619, 622, 625, 626 or 716)

Schlage Control™ Mobile Enabled Smart Deadbolt



BE467  
Greenwich  
(GRW)

BE467  
Addison  
(ADD)

Product Identification

BE	467	F
Lock	Function	90 Minute UL



Standard Features

- Keyless, no cylinder design — 100% bump and pick-proof
- Modern credentials — smart credential and/or phone as key
- Wireless freedom — control and program by phone
- Up to 500 users per lock
- Audit trail reports up to 1,000 events
- Fits standard door prep
- 1 year battery life with BLE mobile credential capability enabled.  
1.5 year battery life without BLE mobile credential capability enabled.
- Full suiting with Schlage decorative mechanical locks
- ADA compliant design
- Uses ENGAGE™ Technology
- See page 8 for information on the MT20W Credential Enrollment Reader

Specifications

<b>Latch:</b>	1" x 2 1/4" square and round corner faceplate (round corner standard, square corner included in package) 1" edge bore required	<b>Construction:</b>	All-metal chassis and escutcheons
<b>Strikes:</b>	1 1/8" x 2 3/4", round corner, no box, latch strike	<b>Bore:</b>	2 1/8"
<b>Backset:</b>	Adjustable backset, fits 2 3/8" to 2 3/4" backsets	<b>Credentials:</b>	Supports Schlage MIFARE Classic®, Schlage MIFARE Plus®, Schlage DESFire® EV1 (sold separately), Schlage Mobile Access Credential. Please refer to the Credential Section of the Allegion Electronic Security Price Book.
<b>Door Range:</b>	1 3/4" (thick door kit available - up to 2 1/4")	<b>Stile width:</b>	Minimum 4 1/2" stile for 2 3/8" backset minimum 5" stile for 2 3/4"
<b>Hole Distance:</b>	Minimum 4" center-to-center distance between cross bore holes	<b>Certifications:</b>	90-minute UL Listed A 156.36 Grade 2 ANSI/BHMA certified; Canada UL 20-minute wood door rated. Approved for use where the exterior escutcheon only is exposed to the outdoors.
<b>Battery:</b>	4-AA batteries included, (If loss of battery power occurs, a 9V battery can be used to jump start the lock and provide access with an assigned credential.)		

FINISH CODES & DESCRIPTIONS\*

<b>619</b>	<b>622</b>	<b>625</b>	<b>626</b>	<b>716</b>
Satin Nickel (US15)	Matte Black (US19)	Bright Chrome (US26)	Satin Chrome (US26D)	Aged Bronze (643e)

\* Non-Standard finishes are not available. Available in split finish options for no additional charge.



1. Select Lock Model

Part No.	Description	Price (ea.)
BE467F	Schlage Control Mobile Enabled Smart Deadbolt, UL Listed, 90 minutes	\$501.00

2. Select Design Style

Style/Description	Price (ea.)
(ADD) Addison	No Charge
(GRW) Greenwich	No Charge

3. Select finish style

Finish/Description	Price (ea.)
619 / Satin Nickel	No Charge
622 / Matte Black	No Charge
625 / Bright Chrome	No Charge
626 / Satin Chrome	No Charge
716 / Aged Bronze	No Charge

Latch

Part No.	Description	Price (ea.)
12-398	BE467F 90 Min UL Deadbolt Latch Dual Option (sq+rd) - STANDARD	Not Sold Separately

BE467F Strike Options

Part No.	Description	Price (ea.)
10-116	Round Corner Strike, 1 1/8" x 2 3/4" - STANDARD	n/c
10-094	Square Corner Strike, 1 1/8" x 2 3/4"	n/c
10-095	Square Corner Full Lip Strike, 1 5/8" x 2 1/4" (Lip Length: 1 1/8")	n/c
10-092	Round Corner Full Lip Strike, 1 5/8" x 2 1/4" (Lip Length: 1 1/8")	n/c

Thick Door Kit

Part No.	Description	Price (ea.)
47244555	For doors between 1 3/4" and 2 1/4"	\$25.60

The Schlage Control Deadbolt uses the same Thick Door Kit as the Interconnect. However, due to the differences in latch assemblies, the Deadbolt can accommodate doors up to 2-1/4" in thickness.

Screw Packs

Part No.	Description	Price (ea.)
47250323	Security Screws - Optional Security torx screws	\$7.40
47244557	BE467 screw pack	7.40

For Screw Packs, specify finish option (619, 622, 625, 626 or 716)

**Electronic Locking Systems**



Greenwich

Addison

**Schlage Control™ Smart Locks - Top Sellers**

Product	Finish	Latch	Strike	Lever Style	Price Each
BE467F GRW	619	12-398	10-116	N/A	\$501.00
BE467F GRW	626	12-398	10-116	N/A	501.00
BE467F ADD	619	12-398	10-116	N/A	501.00
BE467F ADD	626	12-398	10-116	N/A	501.00
FE410F GRW	619	12-356	10-152	Latitude	741.00
FE410F GRW	626	12-356	10-152	Latitude	741.00
FE410F ADD	619	12-356	10-152	Latitude	741.00
FE410F ADD	626	12-356	10-152	Latitude	741.00

Note: FE410 locks are 5.5" center-to-center.

**Schlage Smart Credentials**

Product	Type	Description	Price (ea.)	Min. Order
9651	Keyfob	Schlage MIFARE Smart Card 1K bit Keyfob	\$8.30	50
9651T	Thin Keyfob	Schlage MIFARE Smart Card 1K bit thin Keyfob	8.50	50
5551	Card	Schlage MIFARE Plus SE Smart Card 1K byte / 8k bit ISO Glossy White	7.90	100
8520	Card	Schlage MIFARE DESFire EV1 Smart Card 2K byte / 16k bit ISO Glossy White	8.70	100

**Multi-Tech Technology Credentials**

Product	Type	Description	Price (ea.)	Min. Order
9691T	Thin Keyfob	Proximity and Schlage Smart Card combo 1K byte/8K bit ISO thin Keyfob	\$11.20	50
8920	Card	Proximity and Schlage Smart Card combo 2K byte/16k bit ISO Glossy White	12.80	100

**MT20W Credential Enrollment Reader**

Used to read and write to smart credentials within the ENGAGE™ Technology access control platform (For use with Schlage Control™ Smart Locks)	\$675.00
--	----------



Schlage Residential Locks



Elan (ELA)



Jazz (JAZ)



Latitude (LAT)



Broadway (BRW)

Residential F Series  
F - Lock

Function	Description	Lever Style	Finish	Latch	Strike	Cylinder	Price Each
F10	Passage	ELA	619	16-080	10-027	N/A	\$64.00
F40	Privacy	ELA	619	16-080	10-027	N/A	67.00
F170	Dummy	ELA	619	N/A	N/A	N/A	33.00
F10	Passage	ELA	622	16-080	10-027	N/A	64.00
F40	Privacy	ELA	622	16-080	10-027	N/A	67.00
F170	Dummy	ELA	622	N/A	N/A	N/A	33.00
F10	Passage	ELA	625	16-080	10-027	N/A	64.00
F40	Privacy	ELA	625	16-080	10-027	N/A	67.00
F170	Dummy	ELA	625	N/A	N/A	N/A	33.00
F10	Passage	ELA	626	16-080	10-027	N/A	64.00
F40	Privacy	ELA	626	16-080	10-027	N/A	67.00
F170	Dummy	ELA	626	N/A	N/A	N/A	33.00
F10	Passage	ELA	716	16-080	10-027	N/A	64.00
F40	Privacy	ELA	716	16-080	10-027	N/A	67.00
F170	Dummy	ELA	716	N/A	N/A	N/A	33.00
F10	Passage	JAZ	619	16-080	10-027	N/A	64.00
F40	Privacy	JAZ	619	16-080	10-027	N/A	67.00
F170	Dummy	JAZ	619	N/A	N/A	N/A	33.00
F10	Passage	JAZ	622	16-080	10-027	N/A	64.00
F40	Privacy	JAZ	622	16-080	10-027	N/A	67.00
F170	Dummy	JAZ	622	N/A	N/A	N/A	33.00
F10	Passage	JAZ	625	16-080	10-027	N/A	64.00
F40	Privacy	JAZ	625	16-080	10-027	N/A	67.00
F170	Dummy	JAZ	625	N/A	N/A	N/A	33.00
F10	Passage	JAZ	626	16-080	10-027	N/A	64.00
F40	Privacy	JAZ	626	16-080	10-027	N/A	67.00
F170	Dummy	JAZ	626	N/A	N/A	N/A	33.00
F10	Passage	JAZ	716	16-080	10-027	N/A	64.00
F40	Privacy	JAZ	716	16-080	10-027	N/A	67.00
F170	Dummy	JAZ	716	N/A	N/A	N/A	33.00
F10	Passage	LAT	619	16-080	10-027	N/A	64.00
F40	Privacy	LAT	619	16-080	10-027	N/A	67.00
F170	Dummy	LAT	619	N/A	N/A	N/A	33.00
F10	Passage	LAT	622	16-080	10-027	N/A	64.00
F40	Privacy	LAT	622	16-080	10-027	N/A	67.00
F170	Dummy	LAT	622	N/A	N/A	N/A	33.00
F10	Passage	LAT	625	16-080	10-027	N/A	64.00
F40	Privacy	LAT	625	16-080	10-027	N/A	67.00
F170	Dummy	LAT	625	N/A	N/A	N/A	33.00
F10	Passage	LAT	626	16-080	10-027	N/A	64.00
F40	Privacy	LAT	626	16-080	10-027	N/A	67.00
F170	Dummy	LAT	626	N/A	N/A	N/A	33.00
F10	Passage	LAT	716	16-080	10-027	N/A	64.00
F40	Privacy	LAT	716	16-080	10-027	N/A	67.00
F170	Dummy	LAT	716	N/A	N/A	N/A	33.00
F10	Passage	BRW	619	16-080	10-027	N/A	64.00
F40	Privacy	BRW	619	16-080	10-027	N/A	67.00
F170	Dummy	BRW	619	N/A	N/A	N/A	33.00
F10	Passage	BRW	622	16-080	10-027	N/A	64.00
F40	Privacy	BRW	622	16-080	10-027	N/A	67.00
F170	Dummy	BRW	622	N/A	N/A	N/A	33.00
F10	Passage	BRW	625	16-080	10-027	N/A	64.00
F40	Privacy	BRW	625	16-080	10-027	N/A	67.00
F170	Dummy	BRW	625	N/A	N/A	N/A	33.00
F10	Passage	BRW	626	16-080	10-027	N/A	64.00
F40	Privacy	BRW	626	16-080	10-027	N/A	67.00
F170	Dummy	BRW	626	N/A	N/A	N/A	33.00
F10	Passage	BRW	716	16-080	10-027	N/A	64.00
F40	Privacy	BRW	716	16-080	10-027	N/A	67.00
F170	Dummy	BRW	716	N/A	N/A	N/A	33.00

Schlage Residential Locks (continued)



Dover (DOV)



Marin (MAR)



Solstice (SOL)



Solstice (SOL)  
Collins Rose



Broadway (BRW)



Broadway (BRW)  
Collins Rose

Residential J Series  
J - Lock

Function	Description	Lever Style	Finish	Latch	Strike	Cylinder	Price Each
J10	Passage	SOL	619	16-254	10-101	N/A	\$49.00
J40	Privacy	SOL	619	16-254	10-101	N/A	55.00
J170	Dummy	SOL	619	N/A	N/A	N/A	26.00
J10	Passage	SOL	622	16-254	10-101	N/A	49.00
J40	Privacy	SOL	622	16-254	10-101	N/A	55.00
J170	Dummy	SOL	622	N/A	N/A	N/A	26.00
J10	Passage	SOL	625	16-254	10-101	N/A	49.00
J40	Privacy	SOL	625	16-254	10-101	N/A	55.00
J170	Dummy	SOL	625	N/A	N/A	N/A	26.00
J10	Passage	SOL	626	16-254	10-101	N/A	49.00
J40	Privacy	SOL	626	16-254	10-101	N/A	55.00
J170	Dummy	SOL	626	N/A	N/A	N/A	26.00
J10	Passage	SOL	716	16-254	10-101	N/A	49.00
J40	Privacy	SOL	716	16-254	10-101	N/A	55.00
J170	Dummy	SOL	716	N/A	N/A	N/A	26.00
J10	Passage	SOL/COL	619	16-254	10-101	N/A	57.00
J40	Privacy	SOL/COL	619	16-254	10-101	N/A	60.00
J170	Dummy	SOL/COL	619	N/A	N/A	N/A	29.00
J10	Passage	SOL/COL	622	16-254	10-101	N/A	57.00
J40	Privacy	SOL/COL	622	16-254	10-101	N/A	60.00
J170	Dummy	SOL/COL	622	N/A	N/A	N/A	29.00
J10	Passage	SOL/COL	625	16-254	10-101	N/A	57.00
J40	Privacy	SOL/COL	625	16-254	10-101	N/A	60.00
J170	Dummy	SOL/COL	625	N/A	N/A	N/A	29.00
J10	Passage	SOL/COL	626	16-254	10-101	N/A	57.00
J40	Privacy	SOL/COL	626	16-254	10-101	N/A	60.00
J170	Dummy	SOL/COL	626	N/A	N/A	N/A	29.00
J10	Passage	SOL/COL	716	16-254	10-101	N/A	57.00
J40	Privacy	SOL/COL	716	16-254	10-101	N/A	60.00
J170	Dummy	SOL/COL	716	N/A	N/A	N/A	29.00
J10	Passage	BRW	619	16-254	10-101	N/A	49.00
J40	Privacy	BRW	619	16-254	10-101	N/A	55.00
J170	Dummy	BRW	619	N/A	N/A	N/A	26.00
J10	Passage	BRW	622	16-254	10-101	N/A	49.00
J40	Privacy	BRW	622	16-254	10-101	N/A	55.00
J170	Dummy	BRW	622	N/A	N/A	N/A	26.00
J10	Passage	BRW	625	16-254	10-101	N/A	49.00
J40	Privacy	BRW	625	16-254	10-101	N/A	55.00
J170	Dummy	BRW	625	N/A	N/A	N/A	26.00
J10	Passage	BRW	626	16-254	10-101	N/A	49.00
J40	Privacy	BRW	626	16-254	10-101	N/A	55.00
J170	Dummy	BRW	626	N/A	N/A	N/A	26.00
J10	Passage	BRW	716	16-254	10-101	N/A	49.00
J40	Privacy	BRW	716	16-254	10-101	N/A	55.00
J170	Dummy	BRW	716	N/A	N/A	N/A	26.00
J10	Passage	BRW/COL	619	16-254	10-101	N/A	57.00
J40	Privacy	BRW/COL	619	16-254	10-101	N/A	60.00



Schlage Residential Locks (continued)

Residential J Series  
J - Lock (continued)

Function	Description	Lever Style	Finish	Latch	Strike	Cylinder	Price Each
J170	Dummy	BRW/COL	619	N/A	N/A	N/A	29.00
J10	Passage	BRW/COL	622	16-254	10-101	N/A	57.00
J40	Privacy	BRW/COL	622	16-254	10-101	N/A	60.00
J170	Dummy	BRW/COL	622	N/A	N/A	N/A	29.00
J10	Passage	BRW/COL	625	16-254	10-101	N/A	57.00
J40	Privacy	BRW/COL	625	16-254	10-101	N/A	60.00
J170	Dummy	BRW/COL	625	N/A	N/A	N/A	29.00
J10	Passage	BRW/COL	626	16-254	10-101	N/A	57.00
J40	Privacy	BRW/COL	626	16-254	10-101	N/A	60.00
J170	Dummy	BRW/COL	626	N/A	N/A	N/A	29.00
J10	Passage	BRW/COL	716	16-254	10-101	N/A	57.00
J40	Privacy	BRW/COL	716	16-254	10-101	N/A	60.00
J170	Dummy	BRW/COL	716	N/A	N/A	N/A	29.00
J10	Passage	MAR	619	16-254	10-101	N/A	44.00
J40	Privacy	MAR	619	16-254	10-101	N/A	48.00
J170	Dummy	MAR	619	N/A	N/A	N/A	24.00
J10	Passage	MAR	622	16-254	10-101	N/A	44.00
J40	Privacy	MAR	622	16-254	10-101	N/A	48.00
J170	Dummy	MAR	622	N/A	N/A	N/A	24.00
J10	Passage	MAR	625	16-254	10-101	N/A	44.00
J40	Privacy	MAR	625	16-254	10-101	N/A	48.00
J170	Dummy	MAR	625	N/A	N/A	N/A	24.00
J10	Passage	MAR	626	16-254	10-101	N/A	44.00
J40	Privacy	MAR	626	16-254	10-101	N/A	48.00
J170	Dummy	MAR	626	N/A	N/A	N/A	24.00
J10	Passage	MAR	716	16-254	10-101	N/A	44.00
J40	Privacy	MAR	716	16-254	10-101	N/A	48.00
J170	Dummy	MAR	716	N/A	N/A	N/A	24.00
J10	Passage	DOV	619	16-254	10-101	N/A	44.00
J40	Privacy	DOV	619	16-254	10-101	N/A	48.00
J170	Dummy	DOV	619	N/A	N/A	N/A	24.00
J10	Passage	DOV	622	16-254	10-101	N/A	44.00
J40	Privacy	DOV	622	16-254	10-101	N/A	48.00
J170	Dummy	DOV	622	N/A	N/A	N/A	24.00
J10	Passage	DOV	625	16-254	10-101	N/A	44.00
J40	Privacy	DOV	625	16-254	10-101	N/A	48.00
J170	Dummy	DOV	625	N/A	N/A	N/A	24.00
J10	Passage	DOV	626	16-254	10-101	N/A	44.00
J40	Privacy	DOV	626	16-254	10-101	N/A	48.00
J170	Dummy	DOV	626	N/A	N/A	N/A	24.00
J10	Passage	DOV	716	16-254	10-101	N/A	44.00
J40	Privacy	DOV	716	16-254	10-101	N/A	48.00
J170	Dummy	DOV	716	N/A	N/A	N/A	24.00
J40P	Privacy	SEV	619	16-254	10-101	N/A	50.00
J40P	Privacy	SEV	625	16-254	10-101	N/A	50.00
J40P	Privacy	SEV	716	16-254	10-101	N/A	50.00
J40P	Privacy	SOL	619	16-254	10-101	N/A	57.00
J40P	Privacy	SOL	625	16-254	10-101	N/A	57.00
J40P	Privacy	SOL	716	16-254	10-101	N/A	57.00
J40P	Privacy	TOR	619	16-254	10-101	N/A	50.00
J40P	Privacy	TOR	716	16-254	10-101	N/A	50.00
J40P	Privacy	TOR	625	16-254	10-101	N/A	50.00

**B Series Deadbolts**

**PRODUCT IDENTIFICATION**

B	60	N	F
Lock Series	Function	N - 5-pin cylinder N6 - 6-pin cylinder R6 - 6-pin cylinder with FSIC	F - UL Listed, available with B60, B80, B61 and B60R6 J - Less full sized construction T - Full sized construction core core

**PRODUCT IDENTIFICATION**

JD	60	F
Lock Series	Function	F - UL Listed, available with JD81

**Specifications**

**Grade 1 Deadbolts**

- Models:** B60, B62, B80, B81
- Certification:** ANSI/BHMA A156.36, 2010, Grade 1
- Deadbolt:** 1" x 2 1/4", radius corner, 1" housing diameter, 1" throw, latch number 12-321
- Strike:** 1 1/8" x 2 3/4", 1/4" radius corner, strike number 10-116
- Backset:** Adjustable for 2 3/8" or 2 3/4"
- Cylinder:** 5-pin, keyed 5-pin, C keyway, keyed alike (KA)
- Door Range:** 1 3/8" - 1 3/4"
- Keys:** Two cut keys per lock, 5-pin, C section
- Reinforcement:** Door frame strike reinforcer with 3" screws

**Grade 2 Deadbolts with full-size interchangeable core**

- Models:** B60R6
- Certification:** ANSI/BHMA A156.36, 2010, Grade 2
- Deadbolt:** 1" x 2 1/4", radius corner, 1" housing diameter, 1" throw, latch number 12-321
- Strike:** 1 1/8" x 2 3/4", 1/4" radius corner, strike number 10-116
- Backset:** Adjustable for 2 3/8" or 2 3/4"
- Cylinder Core:** Grade 2, 6-pin keyed 6-pin, C keyway, keyed different (KD)
- Door Range:** 1 3/8" - 1 3/4"
- Keys:** Two user keys, 6-pin, C section, control key ordered separately
- Reinforcement:** Door frame strike reinforcer with 3" screws

Locks are furnished with standard features unless otherwise specified. To order locks with non-standard features specify non-standard feature desired

**FINISH CODES & DESCRIPTIONS\***

505	605	608	609	613	618	619	620	621	622	626	716
Lifetime Bright Brass	Bright Brass (US3)**	Satin Brass	Antique Brass (US5)	Oil-Rubbed Bronze (US10B)	Polished Nickel	Satin Nickel (US15)**	Antique Pewter (US15A)	Distressed Nickel	Matte Black (US19)	Satin Chrome (US26D)**	Aged Bronze (643e)**

\* Non-Standard finishes are not available  
\*\* B60R available finishes

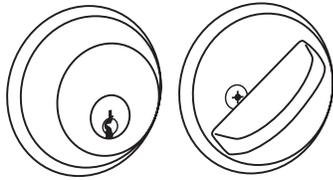

B60

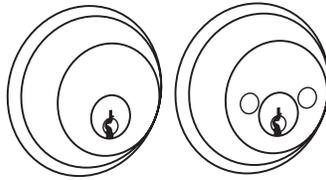

B62

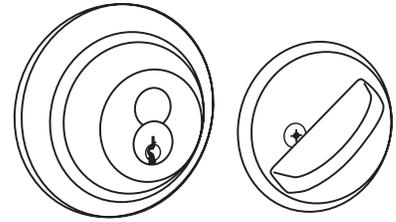

B60R6



## B SERIES

### Standard Features

- BHMA Grade 1 product performance (B60, B62, B80, B81)
- BHMA Grade 2 product performance (B60R6)
- Increased latch/bolt size offers maximum kick-in resistance
- Exclusive patented Schlage design
- Anti-pick shield
- Full-size Interchangeable Core B60R6
- Schlage Limited Lifetime Mechanical and Finish Warranty
- Finishes that feature ultraviolet (UV) resistance up to 4 times the BHMA standard: Satin Nickel, Bright Brass, Antique Brass, and Antique Pewter
- Contoured edges for added style convenience
- Larger thumb turn for easy grip

### GRADE 1 DEADBOLT STANDARD FEATURES/CONFIGURATIONS

<b>Models:</b>	B60, B62, B80, B81
<b>Certification:</b>	ANSI/BHMA A156.36, 2010, Grade 1
<b>Deadbolt:</b>	1" x 2 1/4", radius corner, 1" housing diameter, 1" throw, latch number 12-321
<b>Strike:</b>	1 1/8" x 2 3/4", 1/4" radius corner, strike number 10-116
<b>Backset:</b>	Adjustable for 2 3/8" or 2 3/4"
<b>Cylinder:</b>	5-pin, keyed 5-pin, C keyway, keyed alike (KA4)
<b>Door Range:</b>	1 3/8" - 1 3/4"
<b>Keys:</b>	Two keys per lock, 5-pin, keyed 5-pin, C section
<b>Reinforcement:</b>	Door frame strike reinforcer with 3" screws

\*Locks are furnished with standard features unless otherwise specified  
 To order locks with non-standard features specify non-standard feature desired

**J Series Deadbolts**

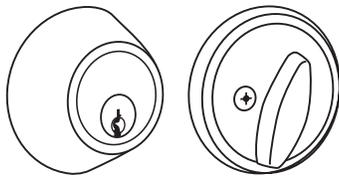

JD60

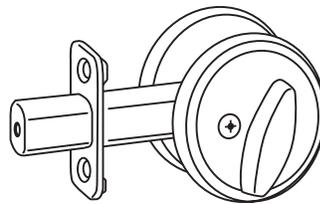

JD81

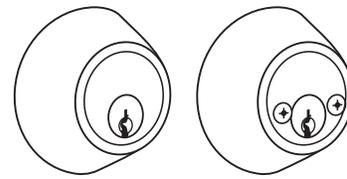

JD62

**JD-SERIES**

**Standard Features**

- Strongest locks in the opening price point category
- Largest knobs and levers in its class
- Fits standard door preps
- Easy to install
- Available with Schlage C keyway standard
- Dual or triple option latches available
- Available UL options (JD81)
- Dexter designs suite with many popular designs from Schlage

**GRADE 3 DEADBOLTS STANDARD FEATURES**

<b>Models:</b>	JD60, JD62, JD81
<b>Certification:</b>	ANSI/BHMA A156.36, 2010, Grade 3
<b>Deadbolt Latch:</b>	Triple Option: 1" x 2 1/4", square corner and 1/4" round faceplates, drive-in latch, 1" housing diameter, 1" throw
<b>Strike:</b>	1" x 2 1/4" round corner
<b>Backset:</b>	Adjustable for 2 3/8" or 2 3/4"
<b>Cylinder:</b>	5-pin, C keyway, keyed alike (KA4)
<b>Door Range:</b>	1 3/8" - 1 3/4"
<b>Keys:</b>	Two keys per lock, 5-pin, keyed 5-pin, C section



### B Series Deadbolts

#### B Series Deadbolts

Function		Packaging	FINISHES											
			605	505	608	609	618	619	620	621	622	625	626	716
B60	Single Cylinder	Box/Vis	\$63	\$69	\$69	\$69	\$69	\$69	\$69	\$69	\$69	\$69	\$69	\$69
B62	Double Cylinder	Box/Vis	91	98	98	98	98	98	98	98	98	98	98	98
B80	One-sided	Box	42	▪	49	49	49	49	49	49	49	49	49	49
B81	One-sided w/trim	Box	44	53	53	53	53	53	53	53	53	53	53	53
B60R6	Single Cylinder Interchgl. Core-6 Pin	Box	▪	181	▪	▪	▪	179	▪	▪	▪	▪	179	181

**List Price Adders:**

UL Latch - add \$6 to list price (B60, B80, B81 and B60R6)

### J Series Deadbolts

#### J Series Deadbolts

Function		Packaging	FINISHES								
			605	609	619	622	625	626	630	716	
JD60	Single Cylinder Deadbolt	Box	\$38	\$38	\$38	\$38	\$38	\$38	\$38	\$38	\$38
JD80	One-Sided Cylinder Deadbolt	Box	34	34	34	▪	▪	▪	34	34	
JD81	One-Sided Deadbolt with trim	Box	34	34	34	▪	▪	▪	34	▪	
JD60F	Single Cylinder UL Version	Box	44	44	44	44	44	44	44	44	
JD60	Single Cylinder Deadbolt	Vis	42	42	42	▪	▪	▪	42	42	
JD62	Double Cylinder Deadbolt	Vis	53	53	53	▪	▪	▪	53	53	

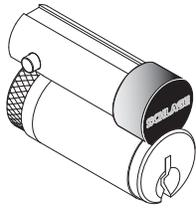

23-030-ICX

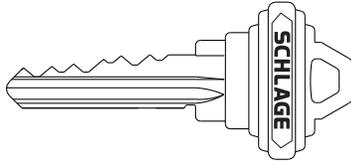

48-101-ICX

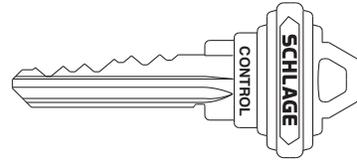

48-056-ICX

### Full-size Construction Core Program

Temporary construction cores may be ordered with full size interchangeable core locks, mortise cylinders and rim cylinders

These cores may also be ordered separately. All construction cores are assessed a non-refundable handling charge (50-231)

See Terms & Conditions for more information

#### Features:

- 5 or 6 Pin C keyway
- Construction cores have a two-tone face: the faceplate is painted orange and the plug is unfinished brass
- Back of each core is marked with the letter that identifies the keyed alike group: A, B or C
- Construction cores are furnished with no keys (NCK). Cut keys must be ordered separately
- A control key is required to install and remove construction cores. Control keys must be ordered separately. If a control key is not ordered, one will be supplied at a charge of \$16.00
- Construction cores may be returned for credit. Contact your Schlage representative for return authorization. Credit is issued upon receipt of cores at our factory

**B Series Deadbolts**
**Full-size Construction Core Program**

Part No.	Description	Specify	Price (ea.)
23-030-ICX	Construction core	New jobs: Specify "ICX"	\$85.00
48-101-ICX	Cut key for construction phase (order separately)	Existing jobs: Specify "ICA" "ICB" or "ICC"	7.80
48-056-ICX	Cut control key (order separately)		16.00
50-231	Non-refundable handling charge (per core)		12.00

**Notes:**

- To order mortise and rim cylinders with full-size construction cores for a new job, suffix ICX to non-Primus cylinder number  
Example: 30-008 ICX. For existing construction core combinations, specify ICA, ICB, or ICC
- Construction cores for a given project are keyed alike to one of a limited number of combinations nationwide  
Other Schlage projects in the same area using the same or different contractors may use the same key

**Example:**

For construction core charges and credits: distributor XYZ ordered 150 construction cores with 20 keys and one control key

The following charges apply to this order:

- 23-030-ICX construction cores (150 units)
- 48-101-ICX cut keys (20 units)
- 48-056-ICX cut control key (1 unit)
- 50-231 non-refundable handling charge (150 units-one per core ordered)

Upon return of the cores to the factory the distributor will be credited for the following:

- 23-030-ICX construction cores (150 units)

There is no credit for the keys or handling fee

**KEY STAMPING (VKC)**

Part No.	Description	Price (ea.)
50-217	Visual key control that allows for visual matching of user and control keys to appropriate cylinders	\$3.30 per key

**Cylinder Stamping (CKC)**

Part No.	Description	Price (ea.)
50-216	Visual cylinder control that allows for visual matching of cylinders to appropriate user and control keys. Must specify VKC for face marking of CKC for side of cylinder marking per cylinder When ordering keys/cylinders marked for ID purposes (VKC & CKC) both PN 50-216 and 50-217 must be ordered as separate items	\$7.90 per cylinder

**Bitting List**

Part No.	Description	Price (ea.)
50-123	Bitting List for factory master keyed products (requires written authorization from end-user)	\$276.00

LE • Introduction

**Finish Codes and Descriptions**

Code		Description
619	(US15)	Satin Nickel
622	(US19)	Matte Black
625	(US26)	Bright Chrome
626	(US26D)	Satin Chrome
643E	(US11)	Aged Bronze



06 (Rhodes)



07 (Athens)



17 (Sparta)



LAT (Latitude)



LON (Longitude)



M52 (Broadway)



M81 (Boardwalk)

**Standard Features**

Certification	ANSI/BHMA Certified A156.25-2013 (Indoor/Outdoor), ANSI/BHMA Certified A156.13-2012, Series 1000, Grade 1 UL 294, ULC S319, UL 10C 3-hour rated
Case Size	4 7/16" x 6 1/16" x 1"
Armor Front	1 1/4" x 8"
Deadbolt	1" throw stainless steel
Latchbolt	3/4" throw stainless steel with anti-friction tongue
Strike	1 1/4" x 4 7/8", square corner, 1 3/16" lip with box and DPS
Backset	2 3/4"
Cylinder	6-Pin solid brass, keyed 6-pin, S123 keyway, keyed different (KD)
Door Range	1 3/4" door thickness standard (can be ordered to accommodate doors 1 3/4" to 2 1/4" thick)
Keys	Two nickel silver cut keys per lock, 6-pin, S123 section



**CONTACT INFORMATION FOR LE SERIES LOCKS & DEVICES**

Payment Address: Schlage Electronic Security  
15934 Collections Center Drive  
Chicago, IL 60693

**877-671-7011**

Customer Service:	Technical Support:
Order Status, Credit Returns of Non-Defective Products, General Sales Questions	Technical Questions/Issues, Returns of Defective Products, Repairs
Email Orders To: Allegion_Orders@allegion.com	Contact For Technical Assistance: Electronic_Lock_TechProdSupport@allegion.com

### LE Wireless Lock Functions

**Function**

Addison Escutcheon Shown

LEBMS* and LEMS - Mortise with LED Indicator	
<b>Storeroom</b>	<p>Lockset is normally secure. Inside lever always allows free egress. Valid toggle credentials on the exterior may be used to change to a passage or secured status. A mechanical key will momentarily unlock the door.</p>
LEBMB* and LEMB - Mortise with Interior Push Button and LED	
<b>Office</b>	<p>Lockset is normally secure. Inside lever always allows free egress. Interior pushbutton on inside housing may be used to select a passage or secured status. Meets need for lockdown function for safety and security. <b>NOTE:</b> Valid toggle credentials on the exterior may also be used to change status. Has interior pushbutton (IPB).</p>
<b>Privacy</b>	<p>Lockset is normally secure. Inside lever always allows free egress. Interior pushbutton on inside housing may be used to select a privacy status. The interior pushbutton will disable normal electronic access from the exterior. Opening the door or pressing the interior pushbutton a second time on the inside housing deactivates the privacy status. Has interior pushbutton (IPB).</p>
<b>Apartment</b>	<p>Lockset is normally secure. Inside lever always allows free egress. Interior pushbutton on inside housing may be used to select a passage or secured status. Opening the door or pressing the interior pushbutton causes the lockset to toggle unsecured. While toggled unsecured, the lockset can only be secured while the door is closed by pressing the interior pushbutton or using a normal credential on the exterior. Normal electronic access from the exterior is always allowed. Has interior pushbutton (IPB).</p>
LEBMD* and LEMD - Mortise Deadbolt with LED	
<b>Privacy</b>	<p>Lockset is normally secure from exterior. Inside lever always allows free egress (if deadbolt is extended, inside knob/lever will simultaneously retract latchbolt and deadbolt). The deadbolt may be used to select a privacy status. With deadbolt extended, normal electronic access from the exterior will be disabled. Opening the door or retracting deadbolt deactivates the privacy status.</p>
<b>Apartment</b>	<p>Lockset is normally secure from exterior. Inside lever always allows free egress (if deadbolt is extended, inside knob/lever will simultaneously retract latchbolt and deadbolt). The deadbolt may be used to select a passage or secured status. Opening the door or retracting the deadbolt causes the lockset to toggle unsecured. While toggled unsecured, the lockset can only be secured while the door is closed by extending the deadbolt from inside or using a normal credential on the exterior reader. Normal electronic access from the exterior is always allowed.</p>

\*Mobile enabled ready. For use with compatible mobile credentials.

### Handing

<b>RH</b>	Right Handed: Hinges on Right Opens Inward	
<b>LH</b>	Left Handed: Hinges on left Opens Inward	
<b>RHR</b>	Right Handed Reverse: Hinges on Right Opens Outward	
<b>LHR</b>	Left Handed Reverse: Hinges on Left Opens Outward	

### LE Wireless Lock - Greenwich Mortise/Mortise Deadbolt



Outside



LEBMS with LED



LEBMB with Interior push button and LED

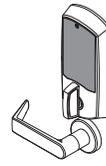

LEBMD Deadbolt with LED

#### 1-3. Select Chassis/Function/Style

Note: Check with access control software partner or PACS provider to verify function and/or mobile enabled version is supported by software.



Part No.	Description	Price Each
LEBMS-GRW	Mobile enabled mortise with LED indicator: Storeroom function	\$1,400.00
LEBMB-GRW	Mobile enabled mortise with push button and LED: Privacy, Office, Apartment functions	1,434.00
LEBMD-GRW	Mobile enabled mortise deadbolt with LED: Privacy, Apartment functions	1,513.00

#### 4. Select Cylinder Type

Note: Maximum door thickness with SFIC Cylinder is 2", otherwise compatible with 1 3/4" to 2 1/4" doors.

P ●▲	Mortise cylinder, Schlage 6-Pin (Everest 29 S123 standard) Also available in formats to support residential customers (5-Pin cylinder with C keyways).	N/C
Z ●	Mortise cylinder, Schlage Everest SL, 7-Pin (factory master keyed only)	N/C
L	Less mortise cylinder	DEDUCT \$115.00
R ●□	FSIC with cylinder, Schlage 6-Pin (Everest 29 S123 standard)	85.00
J	Less FSIC, Schlage, 6-Pin	N/C
T	FSIC construction core	85.00
G6/7 ●□	SFIC with cylinder, Schlage 7-Pin (Everest 29R standard) (factory master keyed only)	100.00
B	Less SFIC, Schlage, Falcon, competitive OEM's, 7-Pin	N/C
H	SFIC construction core	52.00
BDC	SFIC disposable	N/C
50-231	Construction core handling charge (non-refundable)	12.00

● Master keyed cylinders will be shipped in lock package. To specify, send Master Keying System Summary form (page 295 of SES price book) with order or go to [kss.allegion.com](http://kss.allegion.com).

▲ For master keying, an additional charge of \$23.30 each applies. Specify line item 50-210.

□ Control keys for installation/removal of interchangeable cores are not furnished and must be ordered separate.

For additional assistance on Master Keying as well as restricted keyways please contact customer service.

#### 5. Select Outside Lever

Note: Reference page 16 to see style option images.

06	Suites with Rhodes style	N/C
07	Suites with Athens style	N/C
17	Suites with Sparta style	N/C
LAT	Latitude	N/C
LON	Longitude	N/C
M52	Suites with Broadway	30.00
M81	Suites with Boardwalk	30.00

Note: Tactile warning as well as additional lever and knob designs are available; consult your Allegion representative for details

#### 6. Select Outside Finish

626	Satin Chrome	N/C
619	Satin Nickel	74.00
622	Matte Black	74.00
625	Bright Chrome	74.00
643e	Aged Bronze	74.00

Note: additional finishes are available; consult your Allegion representative for details

#### 7. Select Outside Rose

00A	2 1/8" (54 mm) diameter	STANDARD
00B	2 9/16" (65 mm) diameter	N/C
00C	2 5/8" (66 mm) diameter with bevel (Not available in 612 finish)	N/C



LE Wireless Lock - Greenwich Mortise/Mortise Deadbolt (continued)

8. Select Inside Lever

Note: Specify only if different from Outside Lever.

Standard options	06 (Rhodes), 07 (Athens), 17 (Sparta), LAT, LON	N/C
M Collection options*	M52 (Broadway), M81 (Boardwalk)	\$30.00

\* \$30 price adder for M Collection levers only applies if outside lever is Standard.

9. Select Inside Finish

Note: Specify only if different from Outside Finish.

See options in section 6.	74.00*
---------------------------	--------

\* Upcharge only applies if outside finish is 626 and you are specifying a different inside finish.

10. Select Inside Rose

Note: Specify only if different from Outside Rose.

See options in section 7.	N/C
---------------------------	-----

11. Select Handing

(Field reversible)

RH	Right Handed	STANDARD
LH	Left Handed	N/C
RHR	Right Handed Reverse	N/C
LHR	Left Handed Reverse	N/C

12. Select Strike Lip Length

10-136	1 3/16" lip length (MS and MB only)	STANDARD
10-136-112	1 1/2" lip length (MS and MB only)	N/C
10-136-134	1 3/4" lip length (MS and MB only)	32.00
10-072	1 3/16" lip length (MD only)	STANDARD
10-072-112	1 1/2" lip length (MD only)	N/C
10-072-134	1 3/4" lip length (MD only)	36.90

13. Select Door Thickness

134	1 3/4"	STANDARD
200	2"	60.20
214	2 1/4"	60.20

14. Select Keying Type

Open Keyway Families (Mortise cylinder or FSIC) 2

S123	Everest 29 S (Key in Lever or FSIC)	STANDARD
C	Everest	N/C
C/CE/E/EF/F/FG/G	Classic Obverse	N/C

Restricted Keyway Families (Mortise cylinder or FSIC) 1,2,3

29T	Everest 29 T	22.00
D	Everest D	22.00
29R	Everest 29 R (Everest SL)	22.00
B	Everest 29 B (Everest SL)	22.00
<b>Classic Restricted</b>	<b>Quad, Numbered, Reverse</b>	22.00

Restricted Keyway Families (SFIC) 3

29R	Everest 29 R	N/C
B	Everest B	N/C

1. Everest Restricted Keyways require a Letter of Authorization submitted with the order. See sample Letter of Authorization, page 297 of SES price book.
2. Full size key systems (Everest 29 S & T, Everest C & D, Obverse & Quad) are available in Primus and Primus XP key system and must be ordered separately. Lock should be ordered less cylinder and Primus cylinder should be a separate line item.
3. For restricted keyways please see terms and conditions.

Control,NDE, LE and CTE require the use of Allegion's ENGAGE application for electronic access or one of our approved Software Alliance Members. Please consult the Alliance section at us.allegion.com for a full listing of Software Alliance Members.

### LE Wireless Lock - Addison Mortise/Mortise Deadbolt



Outside



LEBMS with LED



LEBMB with Interior push button and LED

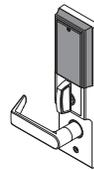

LEBMD Deadbolt with LED

#### 1-3. Select Chassis/Function

Note: Check with access control software partner or PACS provider to verify function and/or mobile enabled version is supported by software.



LEBMS-ADD	Mobile enabled mortise with LED indicator: Storeroom function	1,446.00
LEBMB-ADD	Mobile enabled mortise with push button and LED: Privacy, Office, Apartment functions	1,480.00
LEBMD-ADD	Mobile enabled mortise deadbolt with LED: Privacy, Apartment functions	1,559.00

#### 4. Select Cylinder Type

Note: Maximum door thickness with SFIC Cylinder is 2", otherwise compatible with 1-3/4" to 2-1/4" doors.

P ●△	Mortise cylinder, Schlage 6-Pin (Everest 29 S123 standard) Also available in formats to support residential customers (5-Pin cylinder with C keyways).	N/C
Z ●	Mortise cylinder, Schlage 7-Pin (Everest SL standard) (factory master keyed only)	N/C
L	Less mortise cylinder	DEDUCT \$115.00
R ●□	With SFIC with cylinder, Schlage 6-Pin (Everest 29 S123 standard)	85.00
J	Less SFIC, Schlage, 6-Pin FSIC	N/C
T	With SFIC construction core	85.00
G ●□	With SFIC with cylinder, Schlage 7-Pin (Everest 29R standard) (factory master keyed only)	100.00
B	Less SFIC, Schlage, Falcon, competitive OEM's, 7-Pin	N/C
H	With SFIC construction core	52.00
BDC	With SFIC disposable	N/C
50-231	Construction core handling charge (non-refundable)	12.00

● Master keyed cylinders will be shipped in lock package. To specify, send Master Keying System Summary form (page 295 of SES price book) with order or go to [kss.allegion.com](http://kss.allegion.com)

△ For master keying, an additional charge of \$23.30 each applies. Specify line item 50-210.

□ Control keys for installation/removal of interchangeable cores are not furnished and must be ordered separate.

For additional assistance on Master Keying as well as restricted keyways please contact customer service.

#### 5. Select Outside Lever\*

Note: Reference page 16 to see style option images.

06	Suites with Rhodes style	N/C
07	Suites with Athens style	N/C
17	Suites with Sparta style	N/C
LAT	Latitude	N/C
LON	Longitude	N/C
M52	Suites with Broadway	30.00
M81	Suites with Boardwalk	30.00

Note: Tactile warning as well as additional lever and knob designs are available; consult your Allegion representative for details

#### 6. Select Outside Finish

626	Satin Chrome	N/C
619	Satin Nickel	74.00
622	Matte Black	74.00
625	Bright Chrome	74.00
643e	Aged Bronze	74.00

Note: additional finishes are available; consult your Allegion representative for details

#### 7. Select Outside Rose

(Not applicable to Addison)

#### 8. Select Inside Lever

Note: Specify only if different from Outside Lever.

Standard options	06 (Rhodes), 07 (Athens), 17 (Sparta), LAT, LON	N/C
M Collection options*	M52 (Broadway), M81 (Boardwalk)	30.00

\* \$30 price adder for M Collection levers only applies if outside lever is Standard.



LE Wireless Lock - Addison Mortise/Mortise Deadbolt (continued)

9. Select Inside Finish

Note: Specify only if different from Outside Finish.

See options in section 6.	\$74.00*
---------------------------	----------

\* Upcharge only applies if outside finish is 626 and you are specifying a different inside finish.

10. Select Inside Rose

(Not applicable to Addison)

11. Select Handing

(Field reversible)

RH	Right Handed	STANDARD
LH	Left Handed	N/C
RHR	Right Handed Reverse	N/C
LHR	Left Handed Reverse	N/C

12. Select Strike Lip Length

10-136	1 3/16" lip length (MS and MB only)	STANDARD
10-136-112	1 1/2" lip length (MS and MB only)	N/C
10-136-134	1 3/4" lip length (MS and MB only)	32.00
10-072	1 3/16" lip length (MD only)	STANDARD
10-072-112	1 1/2" lip length (MD only)	N/C
10-072-134	1 3/4" lip length (MD only)	36.90

13. Select Door Thickness

134	1 3/4"	STANDARD
200	2"	60.20
214	2 1/4"	60.20

14. Select Keying Type

Open Keyway Families (Mortise cylinder or FSIC)<sup>2</sup>

S123	Everest 29 S (Key in Lever or FSIC)	STANDARD
C	Everest	N/C
C/CE/E/EF/F/FG/G	Classic Obverse	N/C

Restricted Keyway Families (Mortise cylinder or FSIC)<sup>1,2,3</sup>

29T	Everest 29 T	22.00
D	Everest D	22.00
29R	Everest 29 R (Everest SL)	22.00
B	Everest 29 B (Everest SL)	22.00
Classic Restricted	Quad, Numbered, Reverse	22.00

Restricted Keyway Families (SFIC)<sup>3</sup>

29R	Everest 29 R	N/C
B	Everest B	N/C

1. Everest Restricted Keyways require a Letter of Authorization submitted with the order. See sample Letter of Authorization, page 297.

2. Full size key systems (Everest 29 S & T, Everest C & D, Obverse & Quad) are available in Primus and Primus XP key system and must be ordered separately. Lock should be ordered less cylinder and Primus cylinder should be a separate line item.

3. For restricted keyways please see terms and conditions.

Control, NDE, LE and CTE require the use of Allegion's ENGAGE application for electronic access or one of our approved Software Alliance Members. Please consult the Alliance section at us.allegion.com for a full listing of Software Alliance Members.



**Notes**

**NDE • Introduction**

**Finish Codes and Descriptions**

Code		Description
619	(US15)	Satin Nickel
622	(US19)	Matte Black
625	(US26)	Bright Chrome
626	(US26D)	Satin Chrome
643E	(US11)	Aged Bronze



**06 (Rhodes)**



**07 (Athens)**



**17 (Sparta)**



**LAT (Latitude)**



**LON (Longitude)**



**M52 (Broadway)**

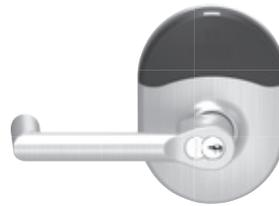

**M81 (Boardwalk)**

**Standard Features**



Certification	ANSI/BHMA Certified A156.25-2013, A156.2-2011, Series 4000, Grade 1, UL 294, UL 10C
Latch	1 1/8" x 2 1/4", Square corner faceplate, 1" housing diameter, 1/2" throw
Strike	1 1/4" x 4 7/8", ANSI Square corner, with DPS magnets, no box
Backset	2 3/4"
Cylinder	6-Pin solid brass, keyed 6-pin, S123 keyway, keyed different (KD)
Door Range	Comes set for 1-3/4" thick doors. Can be field adjusted for doors 1-5/8"-2" thick.
Keys	Two nickel silver cut keys per lock, 6-pin, S123 section

**CONTACT INFORMATION FOR NDE SERIES LOCKS & DEVICES**

Payment Address: Schlage Electronic Security  
15934 Collections Center Drive  
Chicago, IL 60693

<b>877-671-7011</b>	
<b>Customer Service:</b>	<b>Technical Support:</b>
Order Status, Credit Returns of Non-Defective Products, General Sales Questions	Technical Questions/Issues, Returns of Defective Products, Repairs
Email Orders To: Allegion_Orders@allegion.com	Contact For Technical Assistance: Electronic_Lock_TechProdSupport@allegion.com

**NDE Wireless Lock - Cylindrical**



NDEB

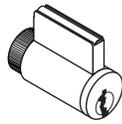

Full Cylinder  
P L L SAR

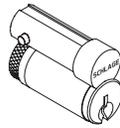

Full Size  
Interchangeable Core  
R J JSAR JCO6 JYA6



Small Format  
Interchangeable Core  
G B



**1-2. Select Chassis/Function**

Part No.	Description	Price Each
NDEB	Mobile Enabled Cylindrical (with interior pushbutton with indicator)	1,113.00

**3. Select Cylinder Type**

P ●	With Cylinder, Schlage - (Everest 29 S123, 6 Pin KIL standard)	N/C
Z ●	With Cylinder, Schlage - Everest SL, 7 Pin KIL (factory master keyed only)	N/C
L	Less Cylinder, Schlage, Falcon, 6 Pin KIL	DEDUCT 75.00
R ● □	With Core, Schlage 6-Pin (Everest 29 S123 standard) FSIC	85.00
J	Less Core, Schlage, 6 Pin FSIC	DEDUCT 45.00
T	With FSIC construction core	85.00
G ● □	With Core, Schlage 7-Pin (Everest 29R standard) (factory master keyed only)	100.00
B	Less Core, Schlage, Falcon, Competitive OEM's, 7 Pin (SFIC)	N/C
L CO6	Less Cylinder, Corbin Russwin KIL, 6 Pin FSIC. Only available on ATH, RHO, SPA, OME, TLR	N/C
L SAR ☞	Less Cylinder, Sargent (10L + 11L), 6 Pin KIL. Only available on ATH, RHO, SPA, OME, TLR	N/C
J SAR ☞	Less Core, Sargent 6300, 6 Pin FSIC. Only available on ATH, RHO, SPA, OME, TLR	N/C
J CO6 ☞	Less Core, Corbin 8000, 6 Pin FSIC. Only available on ATH, RHO, SPA, OME, TLR	N/C
J CO7	Less Core, Corbin 8000-7, 7 Pin FSIC. Only available on ATH, RHO, SPA, OME, TLR	N/C
J MED	Less Core, Medeco 32*0201, 6 Pin FSIC. Only available on ATH, RHO, SPA, OME, TLR	N/C
J YA6 ☞	Less Core, Yale 1210 or Medeco 31*0100, 6 Pin FSIC. Only available on ATH, RHO, SPA, OME, TLR	N/C
J YA7	Less Core, Yale 1220, 7 Pin FSIC. Only available on ATH, RHO, SPA, OME, TLR	N/C
H	With SFIC construction core	52.00
BDC	With SFIC disposable	N/C
50-231	Construction core handling charge (non-refundable)	12.00

- Master Keyed cylinders can be specified and will be shipped in lock packaging. For Master Keying System Summary form which should accompany the master keyed order, see SES Price Book.
  - △ For Master Keying, additional line item 50-210 is required \$23.30 each.
  - Control Keys for installation/removal of interchangeable cores are not furnished and must be ordered separate.
- For additional assistance on Master Keying as well as restricted keyways please contact customer service.  
☞ Extended lead time on all finishes except 626

**4. Select Outside Lever\***

LLL	Less interior and exterior levers	DEDUCT 27.10
SPA	Sparta	N/C
RHO	Rhodes	N/C
ATH	Athens	N/C
TLR	Tubular	N/C
OME	Omega	N/C
LAT	Latitude	N/C
LON	Longitude	N/C
BRW	Broadway	N/C
BRK	Boardwalk	N/C
Tactile options	(8AT, 8LT, 8LN, 8RO, 8SP, 8BK, 8BW, 8TR)	55.00

Note: Tactile warning and additional lever designs are available; consult your Allegion representative for details

**5. Select Outside Finish**

626	Satin Chrome	N/C
605	Bright Brass	74.00
606	Satin Brass	74.00
612	Satin Bronze	74.00
619	Satin Nickel	74.00
622	Matte Black	74.00
625	Bright Chrome	74.00
643e	Aged Bronze	74.00
626AM	Satin Chrome Antimicrobial	105.00

Note: additional finishes are available; consult your Allegion representative for details

**NDE Wireless Lock - Cylindrical (continued)**
**6. Select Inside Lever\***

(Specify only if different from Outside Lever)

LLL	Less interior and exterior levers	DEDUCT 27.10
SPA	Sparta	N/C
RHO	Rhodes	N/C
ATH	Athens	N/C
TLR	Tubular	N/C
OME	Omega	N/C
LAT	Latitude	N/C
LON	Longitude	N/C
BRW	Broadway	N/C
BRK	Boardwalk	N/C
Tactile options	(8AT, 8LT, 8LN, 8RO, 8SP, 8BK, 8BW, 8TR)	55.00

**7. Select Inside Finish**

(Specify only if different from Outside Finish)

626	Satin Chrome	N/C
605	Bright Brass	74.00
606	Satin Brass	74.00
612	Satin Bronze	74.00
619	Satin Nickel	74.00*
622	Matte Black	74.00*
625	Bright Chrome	74.00*
643e	Aged Bronze	74.00*
626AM	Satin Chrome Antimicrobial	105.00

\* Charge only applies if outside finish is 626 and you are specifying a different inside finish.

**8. Select Backset & Latchbolt**

LLL	Less Latch	DEDUCT 41.60
13-247	2 3/4" Backset, Deadlatch, Square corner, 1 1/8" x 2 1/4"	STANDARD
14-042	2 3/4" Backset, Deadlatch Anti-friction fire door latch, Square corner,	213.00
14-047	2 3/8" Backset, Deadlatch Square corner, 1-1/8" x 2 1/4"	N/C
14-048	2 3/8" Backset, Deadlatch Square corner, 1" x 2 1/4"	N/C

**9-10. Select Strike Plate and Strike Lip Length**

47267101	1 3/16" Lip, ANSI, DPS magnets, no box, 1 1/4" x 4 7/8"	STANDARD
10-016 <sup>†</sup>	1 1/8" Lip, Square Corner, T-strike, fire door latch	20.70
K510-066	Box for ANSI strike (Must be specific)	N/C

\* 1-3/8" Lip available, must specify 1-3/8" Lip \$15.60, 1-1/2" Lip available, must specify 1-1/2" Lip \$16.70

\*\* 1-1/2" Lip available, must specify 1-1/2" Lip \$9.10

† DPS magnet requires prep and install beneath strike

**11. Select Keying Type**
**Open Keyway Families: KIL or FSIC<sup>2</sup>**

S123	Everest 29 S (Key in Lever or FSIC)	STANDARD
C	Everest C	N/C
C/CE/E/EF/ F/ FG/ G	Classic Obverse	N/C

**Restricted Keyway Families: KIL or FSIC<sup>1,2</sup>**

29 T	Everest 29 T	22.00
D	Everest D	22.00
29R	Everest 29 R (Everest SL)	22.00
B	Everest B (Everest SL)	22.00
Classic Restricted	Quad, Numbered, Reverse	22.00

**Restricted Keyway Families: SFIC<sup>3</sup>**

29R	Everest 29 R	N/C
B	Everest B	N/C

<sup>1</sup> Everest Restricted Keyways require a Letter of Authorization to be submitted with the order. See sample Letter of Authorization, see SES Price Book.

<sup>2</sup> Full Size key systems (Everest 29 S & T, Everest C & D, Obverse & Quad) are available in Primus and Primus XP key system and must be ordered separately. Lock should be ordered less cylinder and Primus cylinder should be a separate line.

<sup>3</sup> Master Keyed cylinders can be specified and will be shipped in lock packaging. For Master Keying System Summary form which should accompany the master keyed order, see SES Price Book.

Control, NDE, LE and CTE require the use of Allegion's ENGAGE application for electronic access or one of our approved Software Alliance Members. Please consult the Alliance section at us.allegion.com for a full listing of Software Alliance Members.

The CTE is an ENGAGE™ enabled single opening controller that allows perimeter and common area openings to be managed in a single system along with Schlage Control™ smart deadbolts, NDE cylindrical and LE mortise wireless locks. It is ideal for multi-family, commercial mixed use, and retail store front applications.

The CTE is designed to work with a Schlage® Mobile Enabled Multi-Technology reader and interface with an electrified lock, electromagnetic lock, electric strike, automatic operator or exit device to control an opening.

**The CTE single door controller with mobile enabled multi-technology reader kit can be used in a variety of applications; below are a few examples.**

Please note; all components are sold separately.

ENGAGE™ cloud via mobile device or Wi-Fi, or Software Alliance Member (SAM) via Wi-Fi or GWE with IP to host

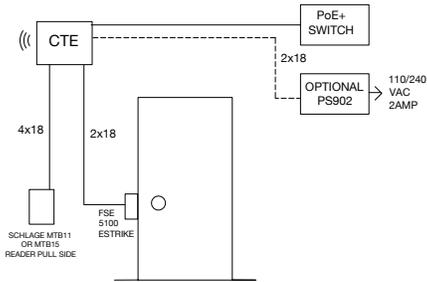

**Operation:** Presenting a valid credential to Schlage MTB XX reader will cause fail secure 5100 electric strike to release for authorized entrance. Free egress always.

**Products:** We offer a variety of electric strikes from Locknetics™ and Von Duprin®, as well as Schlage Power Supplies to meet the specific needs of the opening.

ENGAGE™ cloud via mobile device or Wi-Fi, or Software Alliance Member (SAM) via Wi-Fi or GWE with IP to host

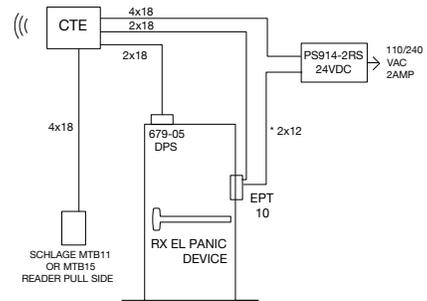

**Operation:** Presenting a valid credential to Schlage MTB XX will cause EL panic device to retract for authorized entrance. Free non-alarmed egress at all times.

**Products:** We offer a variety of Falcon® and Von Duprin exit devices, and Von Duprin power supplies to meet the specific needs of the opening.

ENGAGE™ cloud via mobile device or Wi-Fi, or Software Alliance Member (SAM) via Wi-Fi or GWE with IP to host

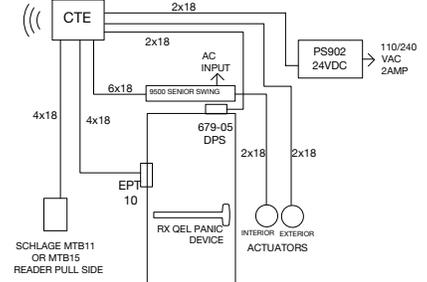

**Operation:** Presenting a valid credential to Schlage MTB XX will cause QEL panic device to retract for authorized entrance and enable exterior actuator. Free non-alarmed egress at all times. Interior actuator always active to retract QEL panic and open door.

**Products:** We offer a variety of hardware and accessories from Von Duprin, LCN®, Schlage and Locknetics to meet the specific needs of the opening.

**Certifications:** UL 294 Indoor, FCC Part 15, NEMA Enclosure Indoor (Type 1, 4, and 4X), ULC S319 Indoor, RoHS

**CTE Series - How to Order:**

**1. CTE**

**2. Reader Type**

- MTB11 Mobile Enabled Multi-Technology Mullion Mount
- MTB15 Mobile Enabled Multi-Technology Single Gang Wall Mount

**3. Cover Color (optional)**

- B Black - default
- C Cream

REQUIRED FIELDS			Options	
CTE	-	MTB15	-	B

**1-2. Select CTE Kit Reader Option**

- CTE-MTB11 ..... CTE with Mobile Enabled Multi-Technology Mullion Reader Kit..... \$1,320.00
- CTE-MTB15 ..... CTE with Mobile Enabled Multi-Technology Single Reader Kit..... \$1,320.00

**3. Select Color**

- B ..... Black – Default ..... N/C
- C ..... Cream ..... N/C



Residential Electronics Accessories

Electromagnetic Locks

Model	Description	Price Each
M420	500lb maglock	\$659.00
M490	High security 1500lb maglock	824.00
M490P	High security 1500lb maglock - plus	1,068.00
M492	Double mag lock 1500 lbs per leaf	1728.00
450/490-ATS/LED	Anti-Tamper Switch (ATS), MBS indicator (LED) for M450P/M452P only	91.50
M452P	Double mag lock with 1000 lbs holding force per leaf with MBS, DPS and RTD	2,081.00
M490G	Gate maglock	834.00
M450P	1000 lbs hold force single mag lock with MBS, DPS and RTD	1,002.00
M452P.ATS/LED-2	Double mag lock with 1000 lbs hold force per leaf with MBS, DPS and RTD	2,266.00
M490DEP	High security 1500lb delayed egress maglock - plus	2,661.00
M490DE	High security 1500lb delayed egress maglock	1,773.00
GF3000	Mortise shear maglock	1,321.00

## Electronic Locking Systems

### Networked Readers

#### Schlage Networked Readers

Function	Description	Price Each
MTB15	Mobile Enabled Multi-Technology Reader - Wall Mount	\$442.00
MTB11	Mobile Enabled Multi-Technology Reader - Mullion	422.00
MTKB15	Mobile Enabled Multi-Technology Reader - Wall Mount w/ Keypad	680.00

### Electronics Accessories

Part Number	Description	Price Each
Scan II - W	Motion Scanner/PIR - white	\$635.00
679-05	Wood Door and Frame door position switch	72.20
679-05HM	Hollow Metal Door and Frame door position switch	99.90
679-05WD	Wood Door and Metal Frame door position switch	119.00
7764	Concealed /Flush mount door position switch	241.00
7766	Surface mount door position switch	255.00
653-04 SF-626	Heavy duty SPDT maintained single direction keyswitch	331.50
653-05 SF-626	Heavy duty SPDT momentary single direction keyswitch	331.50
788C-18	18" x 3/8" Armored door cord with 26" 4-conductor wire	140.00
798-12	12" x 1/2" Armored Door Cord	90.50
798-18	18" x 1/2" Armored Door Cord	114.00
660-PB	Surface mini box SPDT momentary pushbutton	171.00
701RD	Entry level pushbutton, red	161.00
709RD EX ILL	Entry level pushbutton, 2" square, Illuminated Red "Push to Exit"	188.00
709GR EX ILL	Entry level pushbutton, 2" square, Illuminated Green "Push to Exit"	188.00
709BLH ILL	Entry level pushbutton, 2" square, Illuminated Blue Handicapped Symbol	188.00
621RD EX SF-626	1 1/4" Heavy duty pushbutton, red "push to exit"	264.50
623RD EX SF-626	1 5/8" Heavy duty pushbutton, red "push to exit"	264.50
625RD EX SF-626	2 3/4" Heavy duty pushbutton, red "push to exit"	264.50
621GR EX SF-626	1 1/4" Heavy duty pushbutton, green "push to exit"	264.50
623GR EX SF-626	1 5/8" Heavy duty pushbutton, green "push to exit"	264.50
625GR EX SF-626	2 3/4" Heavy duty pushbutton, green "push to exit"	264.50
625BLH SF-626	2 3/4" Heavy duty pushbutton, blue handicapped symbol	264.50

### Power Supply

Part Number	Description	Price Each
PS902	2A @ 12/24 VDC - field selectable power supply	\$278.00
PS904	4A @ 12/24 VDC - field selectable power supply	526.00
PS914	4A (16A Inrush) @ 12/24 VDC - field selectable power supply	797.00
900-2RS	2 Relay EL/QEL Panic device control board	1915.00
900-FA	Emergency interface relay for fire alarm or emergency power cut	69.00
900-BBK	Battery backup kit, includes PCB and 2 Batteries	269.00

Note: Power Supplies default to Schlage pricing and discount.

**B500 - Single Cylinder Deadbolt Series**

Product	Finish	Latch	Strike	Cylinder	Price Each
B560B	626	12-287	10-094	B - Less SFIC	\$132.00
B560P	626	12-288	10-094	6-Pin (keyed 5) Schlage KD C	97.00
B560B	619	12-288	10-094	B - Less SFIC	138.00
B560P	619	12-287	10-094	6-Pin (keyed 5) Schlage KD C	103.00

**CS210 Interconnect Series**



**Mechanical Interconnect Functions**

**Functions**

ANSI/BHMA Certified A156.12-2013, Grade 2, UL Listed for 3 hour fire door.  
With SFIC interchangeable core cylinders: Grade 3 Security.

**CS210: Entrance, Single Locking**

- Deadbolt operated by key from outside or by turn unit from inside
- Bolt automatically deadlocks when fully thrown
- Latch retracted by lever from either side
- Turning inside lever retracts deadbolt and latch simultaneously for immediate exit



**1. Select Lock Model**

Part No.	Description	Price Each
CS210-B500	Entrance with Commercial Spin Ring	\$486.00
CS210-B60	Entrance with Residential Spin Ring	486.00

**2. Select Interior Design Style**

Style/Description	Price Each
(CAM) Camelot	No Charge
(PLY) Plymouth	No Charge

**3. Select Lever Style**

	Price Each
See page MF-13 for Lever Design Options	No Charge

\*Specify handing - Right Hand is standard

**4. Select Key Cylinder Option**

Style/Description	Price Each
(KD) Keyed Different - STANDARD	No Charge
(KA) Keyed Alike	No Charge

**5. Select finish style**

	605	609	619	622	625	626	643e/716
Finish	\$12.00	\$12.00	\$12.00	\$12.00	\$12.00	n/c	\$12.00

**Interconnect Lever Designs**



**Saturn (SAT)**



**Elan (ELA)**



**Jupiter (JUP)**

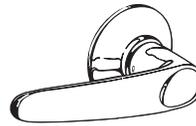

**Jazz (JAZ)**



**Neptune (NEP)**

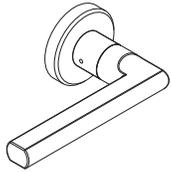

**Latitude (LAT)**



**Boardway (BRW)**

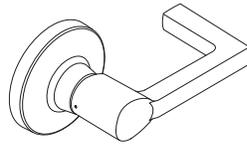

**Boardwalk (BRK)**

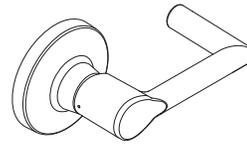

**Longitude (LON)**

Handing must be specified for split finishes and/or designs. Right Hand is standard.

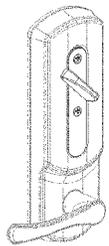

**Plymouth (PLY)**

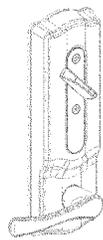

**Camelot (CAM)**

**Available Finishes**

	619	622	625	626	643e/716
Broadway	▪	▪	▪	▪	▪
Boardwalk	▪	▪	▪	▪	▪
Elan	▪	▪	▪	▪	▪
Jazz	▪	▪		▪	▪
Jupiter	▪	▪	▪	▪	▪
Latitude	▪	▪	▪	▪	▪
Longitude	▪	▪	▪	▪	▪
Neptune	▪	▪	▪	▪	▪
Saturn	▪	▪	▪	▪	▪

**L Series - Introduction**

### Product Identification

**L/LV 9 4 53 P**

**Cylinder Suffix**

- P** = Conventional, 6 Pin/Keyed 5
- P6** = Conventional, 6 pin
- L** = Less Conventional, 6 Pin
- R** = FSIC with Schlage Logo
- J** = Less FSIC
- F** = FSIC without Logo
- T** = FSIC - Construction Core
- B** = Less SFIC
- BDC** = Disposable Construction SFIC
- G6/7** = SFIC (6 or 7 pin)
- H** = Refundable Construction SFIC

**Function**

- 0** = No Deadbolt
- 1** = Dummy Trim
- 4** = With Deadbolt

**Lock Series Prefix**

- 0** = Dummy Trim without Lock Case
- 9** = Functions with Lock Case

**Lock Series Prefix**

- L** = Standard
- LV** = Vandlgard

**SFIC = Small Format (Best® Style) Interchangeable Core**

### Finish Codes and Descriptions

Code		Description
619	(US15)	Satin Nickel
622	(US19)	Matte Black
625	(US26)	Bright Chrome
626	(US26D)	Satin Chrome
643E	(US11)	Aged Bronze

### Standard Features

<p>Certifications</p> <p>Case Size</p> <p>Armor Front</p> <p>Deadbolt</p> <p>Latchbolt</p> <p>Strike</p> <p>Backset</p> <p>Cylinder</p> <p>Door Range</p> <p>Keys</p>	<p>L/LV9000: ANSI/BHMA Certified A156.13-2012, Series 1000, Grade 1 Operational, Grade 1 Security, UL Listed for 3-hour fire door (except L9076 and L9077). With FSIC Interchangeable Core Cylinders: Grade 1 Operational, Grade 2 Security. With SFIC Interchangeable Core Cylinders: Grade 1 Operational, Grade 3 Security.</p> <p>L400: ANSI/BHMA Certified A156.36-2010, Grade 1, UL Listed for 3-hour fire door.</p> <p>L/LV9000: 4 7/16" x 6 1/16" x 1"; L400: 4 7/16" x 3 5/8" x 1"</p> <p>L/LV9000: 1 1/4" x 8"; L400: 1 1/4" x 5 9/16"</p> <p>1" Throw stainless steel</p> <p>3/4" Throw stainless steel with anti-friction tongue</p> <p>L/LV9000: 1 1/4" x 4 7/8" Square corner, 1 3/16" lip, box; L400: 1 1/8" x 3 5/8" square corner, box</p> <p>2 3/4"</p> <p>6-Pin solid brass, keyed 6-pin, S123 keyway, keyed different (KD)</p> <p>1 3/4"</p> <p>Two nickel silver cut keys per lock, 6-pin, S123 section</p>
---	---

**L - Functions**

ANSI/BHMA Certified A156.13-2012, Series 1000, Grade 1 Operational, Grade 1 Security, UL Listed for 3-hour fire door (except L9076 and L9077).

**Mortise Locks Non-Keyed**

SCHLAGE ANSI

**L9010**

**F01**

**Passage Latch**

Latchbolt retracted by knob/lever from either side at all times. Inside knob/lever is always free for immediate egress.

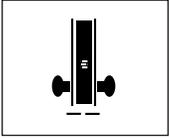

**Mortise Locks Non-Keyed Dummy**

SCHLAGE ANSI

**L0170**

**Half Dummy Trim**

Knob/lever on one side fixed by mounting bar. Not for use on wood doors, or with L escutcheon recommend L9175.

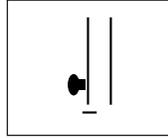

**L9040  
LV9040**

**F22**

**Bath/Bedroom Privacy Lock**

Latchbolt retracted by knob/lever from either side unless outside is locked by inside thumbturn. Turning inside knob/lever or closing door unlocks outside knob/lever. To unlock from outside, remove emergency button, insert emergency thumbturn (furnished) in access hole and rotate. Inside knob/lever is always free for immediate egress.

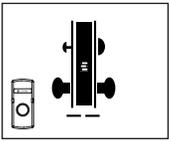

**L0172**

**Full Dummy Trim**

Knob/lever on both sides fixed by mounting bar.

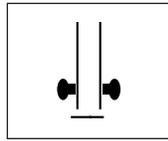

**L9044  
LV9044**

**Privacy With Coin Turn Outside**

Latchbolt retracted by knob/lever from either side unless outside is locked by inside thumbturn or outside coin turn. Operating inside knob/lever, closing door, rotating inside thumbturn or rotating outside coin turn unlocks outside knob/lever. Specify per L283-056 for Torx® screws. Available with rose trim only.

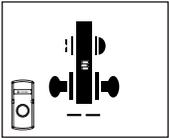

**L9175**

**Half Dummy Trim w/ Lock Case**

Fixed knob/lever on one side inoperable. Includes lock case and armored front. Options same as L9176 below.



**L9440  
LV9440**

**F19**

**Privacy With Deadbolt**

Latchbolt retracted by knob/lever from either side. Deadbolt thrown or retracted by inside thumbturn. Throwing deadbolt locks outside knob/lever. Rotating inside knob/lever simultaneously retracts deadbolt and latchbolt, and unlocks outside knob/lever. To unlock from outside, remove emergency button, insert emergency thumbturn in access hole and rotate. Inside knob/lever is always free for immediate egress.

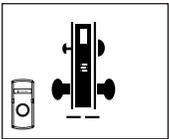

**L9176**

**Full Dummy Trim w/ Lock Case\***

Fixed knob/lever on both sides. Includes lock case and blank armor front. May be ordered with optional XL11-743 armored front with cutout to receive deadbolt.

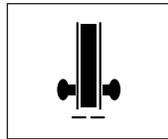

**L9444  
LV9444**

**Privacy With Deadbolt and Coin Turn Outside**

Latchbolt retracted by knob/lever from either side. Deadbolt thrown or retracted by inside thumbturn or outside coin turn. Throwing deadbolt locks outside knob/lever. Rotating inside knob/lever simultaneously retracts deadbolt and latchbolt, and unlocks outside knob/lever. Rotating outside coin turn retracts deadbolt and unlocks outside knob/lever. Specify per L283-056 for Torx screws. Available with rose trim only. Inside knob/lever is always free for immediate egress.

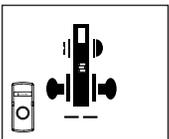

LV- Vandgard function allows exterior lever to rotate freely down, while remaining securely locked.

\* In a double door application where the dummy will be used as the strike, order 10-091 Armored Front Strike separately.



180 degree messaging indicator available. See options section for details.

Additional functions as well as Mortise Deadbolts are available; please consult your Allegion representative for details.

**L - Functions**

**Mortise Locks Keyed**

SCHLAGE ANSI

**L9050 F04  
LV9050**

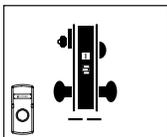

**Entrance/Office Lock**  
Latchbolt retracted by knob/lever from either side unless outside is made inoperative by key outside or by turning inside thumbturn. When outside is locked, latchbolt is retracted by key outside or by knob/lever inside. Outside knob/lever remains locked until thumbturn is returned to vertical or unlocked by key. Auxiliary latch deadlocks latchbolt when door is locked. Inside knob/lever is always free for immediate egress.

**L9056 F22  
LV9056**

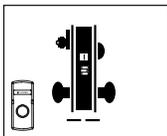

**L9050 With Automatic Unlocking**  
Latchbolt retracted by knob/lever from either side unless outside is made inoperative by key outside or by rotating inside thumbturn. Outside knob/lever unlocked by key outside, thumbturn or closing door. Rotating inside knob/lever simultaneously retracts latchbolt and unlocks outside knob/lever. Auxiliary latch deadlocks latchbolt when door is locked. Inside knob/lever is always free for immediate egress.

**L9060 F09  
LV9060**

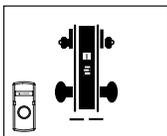

**Apartment Entrance Lock**  
Latchbolt retracted by knob/lever from either side unless outside is locked by key from inside. When locked, latchbolt retracted by key outside or knob/lever inside. Auxiliary latch deadlocks latchbolt when door is locked. Inside knob/lever is always free for immediate egress.

**L9080 F07  
LV9080**



**Storeroom Lock**  
Latchbolt retracted by key outside or by knob/lever inside. Outside knob/lever always inoperative. Auxiliary latch deadlocks latchbolt when door is locked. Inside knob/lever is always free for immediate egress.

LV- Vandgard function allows exterior lever to rotate freely down, while remaining securely locked.

\* **Caution:** Double cylinder locks on residences and any door in any structure which is used for egress are a life safety hazard in times of emergency and their use is not recommended. Installation should be in accordance with existing codes only.



180 degree messaging indicator available. See options section for details.

**Mortise Locks-Keyed with Deadbolt**

SCHLAGE ANSI

**L9453 F20  
LV9453**



**Entrance/Office Lock with Deadbolt**  
Latchbolt retracted by knob/lever from either side unless outside is locked by 20° rotation of thumbturn. Deadbolt thrown or retracted by 90° rotation of thumbturn. When locked, key outside or knob/lever inside retracts deadbolt and latchbolt simultaneously. Outside knob/lever remains locked until thumbturn is restored to vertical position. Throwing deadbolt automatically locks outside knob/lever. Auxiliary latch deadlocks latchbolt when door is locked. Inside knob/lever is always free for immediate egress.

**L9456 F13  
LV9456**



**Corridor Lock**  
Latchbolt retracted by knob/lever from either side. Deadbolt thrown or retracted by key outside or inside thumbturn. Throwing deadbolt locks outside knob/lever. Turning inside knob/lever simultaneously retracts deadbolt and latchbolt and unlocks outside knob/lever. Inside knob/lever is always free for immediate egress.

**L9465**

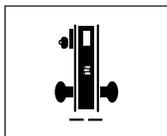

**Closet/Storeroom Lock**  
Latchbolt retracted by knob/lever from either side. Deadbolt thrown or retracted by key outside.

**L9466 F14**

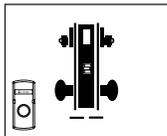

**Store/Utility Room Lock\***  
Latchbolt retracted by knob/lever from either side. Deadbolt thrown or retracted by key from either side.

**L9473 F21**

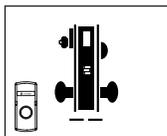

**Dormitory/Bedroom Lock**  
Latchbolt retracted by knob/lever from either side. Deadbolt thrown or retracted by key outside or thumbturn inside.

**L9480 LV9480**

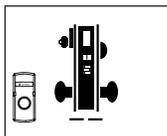

**Storeroom Lock With Deadbolt**  
Latchbolt retracted by key outside or by lever or knob inside. Outside knob/lever always fixed. Deadbolt thrown or retracted by key outside or thumbturn inside. Turning inside knob/lever simultaneously retracts both deadbolt and latchbolt. Auxiliary latch deadlocks latchbolt when door is locked. Inside knob/lever is always free for immediate egress.

Additional functions as well as Mortise Deadbolts are available; please consult your Allegion representative for details.

## L909x EL/EU Electrified Locks

All locks feature automatic detection and operation with 12 or 24V DC, and a case-mounted switch that allows customer selection of EL (fail safe) or EU (fail secure) operation. Please specify lock function as EL or EU for default switch position. Locks also come standard with Allegion Connect moxex connector with 3" lead. Allegion Connect is a moxex connector system that allows rapid installation of locks when used with Allegion Connect Harnesses and Allegion Connect Hinges (see lves pricebook). For more information speak with your sales representative. The moxex connector can also be cut off so that the lock can be installed with traditional splicing.

Available options for electrified functions: Request to Exit specify RX in the option string  
 Latchbolt Monitor specify LX in the option string  
 Door Position Sensor specify DPS in the option string (non deadbolt models only)  
 Deadbolt Monitor specify DM in the option string (deadbolt models only)

### L9090EL L9090EU **Electrically locking/unlocking outside lever, no cylinder**



Outside knob/lever continuously locked (EL) or unlocked (EU) by 12 or 24V DC. Inside lever always free for immediate egress.

### L9091EL L9091EU **Electrically locking/unlocking both levers, no cylinder**



Inside and outside knob/lever continuously locked (EL) or unlocked (EU) by 12 or 24V DC.

### L9092EL L9092EU **Electrically locking/unlocking outside lever, Outside cylinder (replaces L9080EL/EU)**



Outside knob/lever continuously locked (EL) or unlocked (EU) by 12 or 24V DC. Latchbolt retracted by key outside or knob/lever inside. Aux latch deadlocks latchbolt when door is locked. Inside lever always free for immediate egress.

### L9093EL L9093EU **Electrically locking/unlocking both levers, Outside cylinder**



Inside and outside knob/lever continuously locked (EL) or unlocked (EU) by 12 or 24V DC. Latchbolt retracted by key outside. EL is fail safe (power failure allows either knob/lever to retract latchbolt); EU is fail secure (power failure locks both knobs/levers). Aux latch deadlocks latchbolt when door is locked

### L9095EL L9095EU **Electrically locking/unlocking both levers, Inside and outside cylinder (replaces L9082EL/EU)**



Inside and outside knob/lever continuously locked (EL) or unlocked (EU) by 12 or 24V DC. Latchbolt retracted by key inside or outside. Aux latch deadlocks latchbolt when door is locked.

### L9492EL L9492EU **Electrically locking/unlocking outside lever, outside cylinder, inside thumbturn, with deadbolt**



Outside knob/lever continuously locked (EL) or unlocked (EU) by 12 or 24V DC. Deadbolt thrown or retracted by key outside or thumbturn inside. Turning inside knob/lever retracts deadbolt and opens door. When unlocked, rotating outside lever retracts deadbolt and opens door. Aux latch deadlocks latchbolt when door is shut. Inside lever always free for immediate egress. Deadbolt projection does not control outside lever lock/unlock state.

### L9493EL L9493EU **Electrically locking/unlocking both levers, outside cylinder, inside thumbturn, with deadbolt**



Inside and outside knob/lever continuously locked (EL) or unlocked (EU) by 12 or 24V DC. Deadbolt thrown or retracted by key outside or thumbturn inside. When unlocked, rotating inside or outside lever retracts deadbolt and opens door. Aux latch deadlocks latchbolt when door is shut. Deadbolt projection does not control outside lever lock/unlock state.

### L9494EL L9494EU **Electrically locking/unlocking outside lever, inside and outside cylinders, with deadbolt**



Outside knob/lever continuously locked (EL) or unlocked (EU) by 12 or 24V DC. Deadbolt thrown or retracted by key outside or inside. Turning inside knob/lever retracts deadbolt and opens door. When unlocked, rotating outside lever retracts deadbolt and opens door. Aux latch deadlocks latchbolt when door is shut. Inside lever always free for immediate egress. Deadbolt projection does not control outside lever lock/unlock state.

### L9495EL L9495EU **Electrically locking/unlocking both levers, inside and outside cylinders, with deadbolt**



Inside and outside knob/lever continuously locked (EL) or unlocked (EU) by 12 or 24V DC. Deadbolt thrown or retracted by key outside or inside. When unlocked, rotating inside or outside lever retracts deadbolt and opens door. Aux latch deadlocks latchbolt when door is shut. Deadbolt projection does not control outside lever lock/unlock state.

Additional functions as well as Mortise Deadbolts are available; please consult your Allegion representative for details.

**L - Complete Locks**  
**Standard Lever Collection A, B or C Rose Trim**

**Cast or Forged Lever Designs with Wrought Roses**

<p><b>06 (Rhodes)</b></p> <p>Not available with C Rose</p>	<p><b>07 (Athens)</b></p>	<p><b>17 (Sparta)</b></p>	<p><b>LAT (Latitude)</b></p>
<p><b>LON (Longitude)</b></p>	<p><b>M52 (Broadway)</b></p>	<p><b>M81 (Boardwalk)</b></p>	

**Note:** Above images shown with A Rose.  
**Note:** A wide variety of additional lever designs are available; consult your Allegion representative for details

**Wrought Rose Designs**

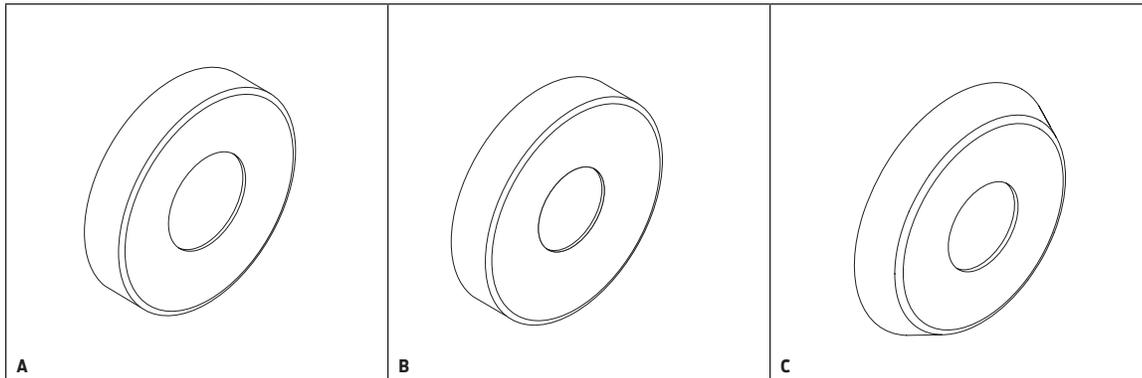

## Complete Locks - L

## L-Series (A, B or C Rose Trim) - Standard Collection levers

Function	Add \$108 for Vandigard Option	Description	06 (Rhodes), 07 (Athens), 17 (Sparta), LAT (Latitude), LON (Longitude)				M52 (Broadway), M81 (Boardwalk)
			626	619	622	625	643e
<b>Keyless Functions</b>							
L9010		Passage	\$812.00	\$824.00		\$842.00	
L9040	•	Privacy	934.00	946.00		964.00	
L9044	•	Privacy w/ coin turn	1,014.00	1,026.00		1,044.00	
L9090&91 EL&EU		Electrified Lock (keyless)	1,308.00	1,320.00		1,338.00	
L9440	•	Privacy w/ deadbolt	1,075.00	1,087.00		1,105.00	
L9444	•	Privacy w/ deadbolt and coin turn	1,151.00	1,163.00		1,181.00	
L0170		Single dummy	292.00	298.00		307.00	
L0172		Double dummy	584.00	596.00		614.00	
L9175		Single dummy with case	435.00	441.00		450.00	
L9176		Double dummy with case	718.00	730.00		748.00	
<b>Keyed Single Cylinder Functions</b>							
L9050P	•	Entrance/Office	\$1,040.00	\$1,052.00		\$1,070.00	
L9056P	•	Entrance/Office with auto unlocking	1,137.00	1,149.00		1,167.00	
L9080P	•	Storeroom	1,040.00	1,052.00		1,070.00	
L9092P&93P EL&EU		Electrified Lock (outside cylinder)	1,410.00	1,422.00		1,440.00	
L9453P	•	Entrance w/ deadbolt	1,075.00	1,087.00		1,105.00	
L9456P	•	Corridor w/ deadbolt					
L9465P		Closet/Storeroom w/ deadbolt					
L9473P		Dorm/Bedroom w/ deadbolt					
L9480P	•	Storeroom w/ deadbolt	1,178.00	1,190.00		1,208.00	
L9492P&93P EL&EU		Electrified lock (outside cylinder, inside thumbturn, deadbolt)	1,663.00	1,675.00		1,693.00	
<b>Keyed Double Cylinder Functions</b>							
L9060P	•	Apartment entrance	\$1,144.00	\$1,156.00		\$1,174.00	
L9095P EL&EU		Electrified Lock (Inside and outside cylinder)	1,513.00	1,525.00		1,543.00	
L9466P		Storeroom w/ deadbolt	1,144.00	1,156.00		1,174.00	
L9494P&95P EL&EU		Electrified lock (inside and outside cylinder, deadbolt)	1,767.00	1,779.00		1,797.00	

**Notes:** 1) For the Everest 29 T and Everest D family of restricted keyways (Quad, Numbered, Reversed) add \$22.00. This does not apply to Primus families. See Terms and Conditions for more information.

**L - Complete Locks**  
**Standard Lever Collection\* Escutcheon Trim**

**Cast or Forged Lever Designs with Cast, Forged, or Wrought Escutcheons**

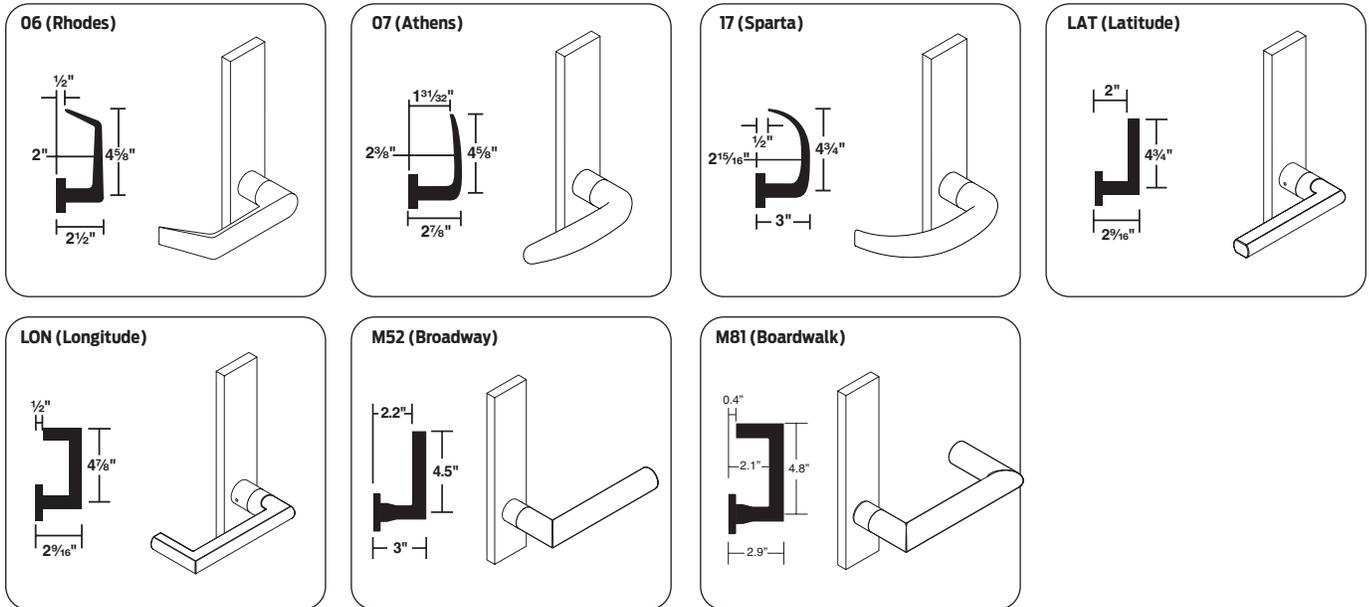

**Note:** Above images shown with L Escutcheon.  
**Note:** A wide variety of additional lever designs are available; consult your Allegion representative for details

**Cast/Forged (L) or Wrought (N)**

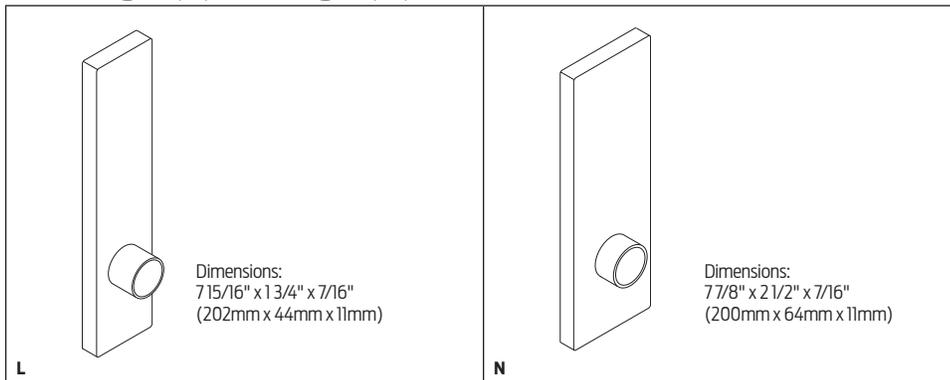



**L - Complete Locks  
L or N Escutcheon Trim**

**L-Series (L or N Escutcheon) - Standard Collection Levers**

Function	Add \$108 for Vandlgard Option	Description	Lever or Knob Designs and Finishes		
			Standard Lead time		
			06 (Rhodes), 07 (Athens), 17 (Sparta), LAT (Latitude), LON (Longitude)		M52 (Broadway), M81 (Boardwalk)
			Finishes		
			626	619 622 625 643e	619, 622, 625, 626, 643e
<b>Keyless Functions</b>					
L9010		Passage	\$841.00	\$853.00	\$871.00
L9040	•	Privacy	963.00	975.00	993.00
L9044	•	Privacy w/ Coin Turn and Outside Indicator (N Escutcheon Only)	1,043.00	1,055.00	1,073.00
L9444	•	Privacy w/ Deadbolt, Coin Turn and Outside Indicator (N Escutcheon Only)	1,180.00	1,192.00	1,210.00
L9090&91 EL&EU		Electrified Lock (keyless)	1,337.00	1,349.00	1,367.00
L9440	•	Privacy w/ Deadbolt	1,104.00	1,116.00	1,134.00
L0170		Single Dummy (N Escutcheon Only)	307.00	313.00	322.00
L0172		Double Dummy	613.00	625.00	643.00
L9175		Single Dummy with Case	450.00	456.00	465.00
L9176		Double Dummy with Case	747.00	759.00	777.00
<b>Keyed Single Cylinder Functions</b>					
L9050P	•	Entrance/Office	\$1,069.00	\$1,081.00	\$1,099.00
L9056P	•	Entrance/Office w/ Auto Unlocking	1,166.00	1,178.00	1,196.00
L9080P	•	Storeroom	1,069.00	1,081.00	1,099.00
L9092P&93P EL&EU		Electrified Lock (outside cylinder)	1,439.00	1,451.00	1,469.00
L9453P	•	Entrance/Office w/ Deadbolt	1,104.00	1,116.00	1,134.00
L9456P	•	Corridor w/ Deadbolt			
L9465P		Closet/Storeroom w/ Deadbolt			
L9473P		Dorm/Bedroom w/ Deadbolt			
L9480P	•	Storeroom w/ Deadbolt	1,207.00	1,219.00	1,237.00
L9492P&93P EL&EU		Electrified lock (outside cylinder, inside thumbturn, deadbolt)	1,692.00	1,704.00	1,722.00
<b>Keyed Double Cylinder Functions</b>					
L9060P	•	Apartment Entrance	\$1,173.00	\$1,185.00	\$1,203.00
L9095P EL&EU		Electrified Lock (Inside and outside cylinder)	1,542.00	1,554.00	1,572.00
L9466P		Storeroom w/ Deadbolt	1,173.00	1,185.00	1,203.00
L9494P&95P EL&EU		Electrified lock (inside and outside cylinder, deadbolt)	1,796.00	1,808.00	1,826.00

- Notes:** 1) For the Everest 29 T and Everest D family of restricted keyways (Quad, Numbered, Reversed) add \$18.00. This does not apply to Primus families. See Terms and Conditions for more information.  
 2) L escutcheon available 1 3/8" - 2 1/2" doors non-Vandlgard functions, 1 3/4" - 2 1/2" doors on Vandlgard functions. N escutcheon available 1 3/4" - 2 1/4" non-Vandlgard and Vandlgard functions



L - Cylinder Options

Cylinder Adjustments

Specify	Description	Lock Price Adjustment (per cylinder)
<b>Full Size Interchangeable Core (FSIC)</b>		
R Suffix	Full size core (furnished 1-bitted w/ two 6-pin keys unless otherwise specified)	\$85.00
J Suffix	Less full size core	N/C
<b>Full Size Construction Core</b>		
T Suffix	Full size construction core (assessed handling charge 50-231 per core)	\$85.00
<b>Small Format Interchangeable Core (SFIC) (Not available with Hotel Functions L9485 or L9486)</b>		
G7 Suffix	Everest patented core (specify key symbol; see Terms & Conditions for more details)	\$100.00
B Suffix	Less small format core	-7.00
<b>Small Format Construction Core &amp; Disposable Core</b>		
H Suffix	Small format construction core (assessed handling charge 50-231 per core)	\$52.00
BDC Suffix	Small format disposable core	-\$12.00
<b>Construction Core Handling Charge</b>		
50-231	Handling charge for construction core (assessed per core, non-refundable)	\$12.00

Notes Control keys are not furnished with locks and must be purchased separately. See Keys & Keying. Interchangeable cores are not available with concealed cylinders.

Ordering instructions: Add suffix to lock function. Ex: L9050J (L9050 function less full size core)

Shaded items are standard components and are furnished with locks unless otherwise specified.

**L - Armor Fronts and Strikes**

**Armor Fronts, L9000**

Specify	Description	Lock Price Adjustment
<b>1 1/4" Wide (Standard armor size for 1 3/4" and larger door thicknesses)</b>		
09-661	Blank (L9175, L9176)	N/C
09-662	Latch only (L9010, L9040, L9044)	
09-663	Latch x aux latch (L9050, L9056, L9060, L9070, L9071, L9080, L9082, L9090/91/92/93/95*)	
09-713	Latch x aux latch (L9076, L9077)	
09-664	Latch x deadbolt (L9440, L9444, L9456, L9457, L9465, L9466, L9473, L9496)	
09-665	Deadbolt (L9460, L9462, L9463, L9464)	
09-666	Latch x aux latch x deadbolt (L9453, L9458, L9480, L9485, L9486, L9492/93/94/95)	
09-717	Deadbolt armor (L460, L462, L463, L464, L480, L496)	
<b>1 1/16" Wide (recommended armor size for doors thinner than 1 3/4", including 1 3/8" doors)</b>		
09-667	Blank (L9175, L9176)	N/C
09-668	Latch only (L9010, L9040, L9044)	
09-669	Latch x aux latch (L9050, L9056, L9060, L9070, L9071, L9080, L9082, L9090/91/92/93/95*)	
09-718	Latch x aux latch (L9076, L9077)	
09-670	Latch x deadbolt (L9440, L9444, L9456, L9457, L9465, L9466, L9473, L9496)	
09-671	Deadbolt (L9460, L9462, L9463, L9464)	
09-672	Latch x aux latch x deadbolt (L9453, L9458, L9480, L9485, L9486, L9492/93/94/95)	

\*For L9090/91/92/93/95 with DPS use armor 09-666 (1-1/4" wide) or 09-670 (1-1/16 wide)

Ordering instructions: Specify on order only if requesting other than default.

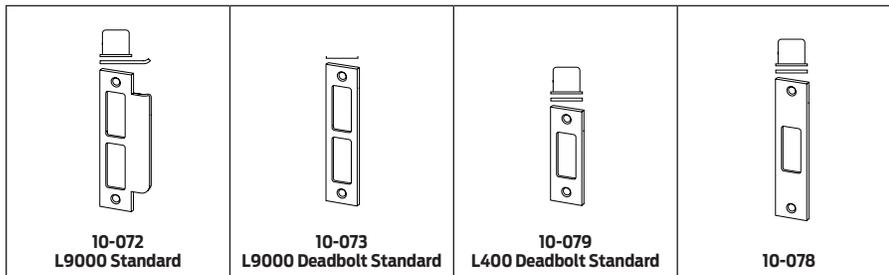

**Strikes, L9000**

Specify	Description	Lock Price Adjustment
<b>Strikes, L9000 Series</b>		
10-072	1 1/4" x 4 7/8" square corner strike + box, 1 3/16" lip length, standard L9000 strike	N/C
10-072 xx	1 1/4" x 4 7/8" square corner strike + box; specify lip length (xx) as 7/8", 1" or 1-1/2"	
10-072 xx	1 1/4" x 4 7/8" square corner strike + box; specify lip length (xx) as 1-3/4" or 2"	\$36.00
10-073	Deadbolt lock strike, standard for L9460, L9462, L9463 and L9464	N/C
10-075	1/2" rabbeted strike	126.00
37-015	Door frame strike reinforcer (finish not applicable)	N/C
<b>Strikes, L400 Series</b>		
10-078	1-1/4" x 4-7/8" square corner strike + box	N/C
10-079	1-1/8" x 3-1/2" square corner strike + box, ANSI 115.5 prep, standard L400 strike	

Ordering instructions: Specify on order only if requesting other than default.

Shaded items are standard components and are furnished with locks unless otherwise specified.

**ND Levers - Functions**

ANSI/BHMA Certified A156.2-2011, Series 4000, Grade 1, UL Listed for 3-hour fire door.

**Non-Keyed Locks**

SCHLAGE    ANSI

**ND10S    F75**



**Passage Latch**

Both levers always unlocked. Inside lever is always free for immediate egress. Also available with Request to Exit (RX) function.

**ND40S    F76**



**Bath/Bedroom Privacy Lock**

Push-button locking. Can be opened from outside with small screwdriver. Turning inside lever or closing door releases button. Inside lever is always free for immediate egress.

**ND170**



**Single Dummy Trim**

Dummy trim for one side of door. Used for door pull or as matching inactive trim.

**Keyed Locks**

SCHLAGE    ANSI

**ND50PD    F82**

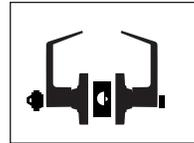

**Entrance/Office Lock**

Push-button locking. Push-button locks outside lever until unlocked with key or by turning inside lever. Inside lever is always free for immediate egress.

**ND53PD    F109**

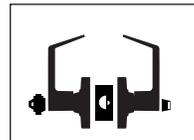

**Entrance Lock**

Turn/push-button locking; pushing and turning button locks outside lever, requiring use of key until button is manually unlocked. Push-button locking; pushing button locks outside lever until unlocked by key or by turning inside lever. Inside lever is always free for immediate egress.

**ND80PD    F86**

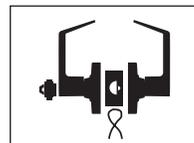

**Storeroom Lock**

Outside lever fixed. Entrance by key only. Inside lever always unlocked for immediate egress. Also available with Request to Exit (RX) function.

**ND80PDEL**

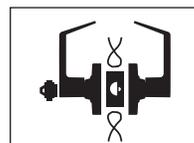

**Electrically Locked (Fail Safe)**

Outside lever continuously locked electrically. Unlocked by key outside or by switch or power failure. Auxiliary latch deadlocks latchbolt when door is closed. Inside lever always unlocked for immediate egress. Also available with Request to Exit (RX) function.

**ND80PDEU**



**Electrically Unlocked (Fail Secure)**

Outside lever continuously locked until unlocked by key or electric current. Auxiliary latch deadlocks latchbolt when door is closed. Inside lever always unlocked for immediate egress. Also available with Request to Exit (RX) function.

**Lever:** ATH - Athens  
**Rose:** Rhodes

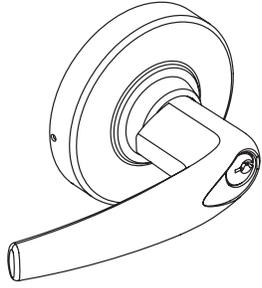

**Lever Grade:** 1  
**Cores:** KIL, FSIC, SFIC, L-SAR, L-CO6, J-SAR, J-CO6

**Lever:** OME - Omega  
**Rose:** Omega

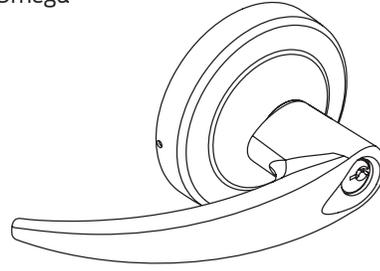

**Lever Grade:** 1  
**Cores:** KIL, FSIC, SFIC

**Lever:** BRW - Broadway  
**Rose:** Rhodes

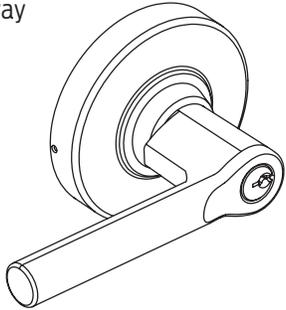

**Lever Grade:** 1  
**Cores:** KIL, FSIC, SFIC

**Lever:** RHO - Rhodes  
**Rose:** Rhodes

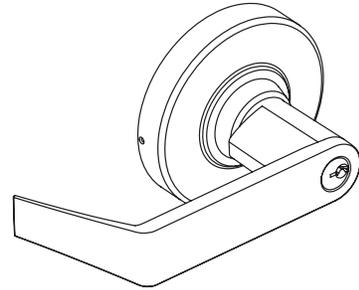

**Lever Grade:** 1  
**Cores:** KIL, FSIC, SFIC, L-SAR, L-CO6, J-SAR, J-CO6, J-CO7

**Lever:** BRK - Boardwalk  
**Rose:** Rhodes

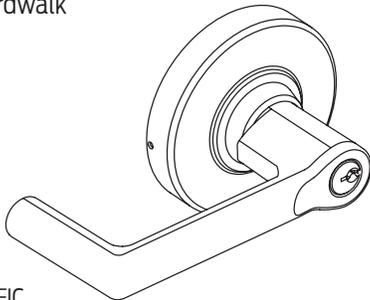

**Lever Grade:** 1  
**Cores:** KIL, FSIC, SFIC

**Lever:** SPA - Sparta  
**Rose:** Rhodes

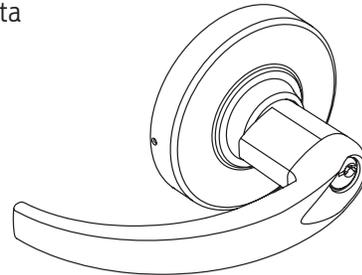

**Lever Grade:** 1  
**Cores:** KIL, FSIC, SFIC, L-SAR, L-CO6, J-SAR, J-CO6

**Lever:** LAT - Latitude  
**Rose:** Rhodes

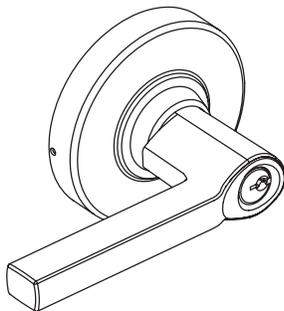

**Lever Grade:** 1  
**Cores:** KIL, FSIC, SFIC

**Lever:** TLR - Tubular  
**Rose:** Rhodes

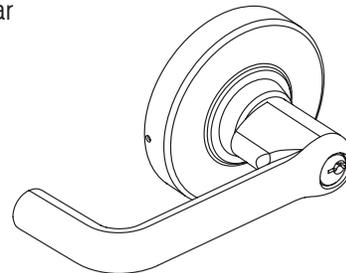

**Lever Grade:** 1  
**Cores:** KIL, FSIC, SFIC, L-SAR, L-CO6, J-SAR, J-CO6

**Lever:** LON - Longitude  
**Rose:** Rhodes

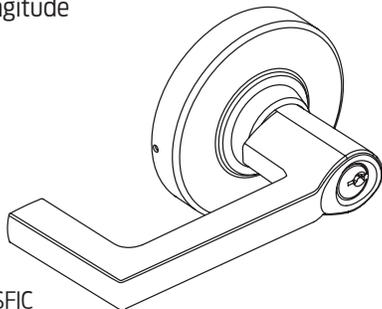

**Lever Grade:** 1  
**Cores:** KIL, FSIC, SFIC

## ND Levers - Complete Locks

Function	Description	Designs and Finishes						PRIMARY CYLINDER ADJUSTMENTS AVAILABLE LEVERS AVAILABLE FINISHES							
		ATH	RHO	SPA	BRW	BRK	LAT	LON	LD	RD	JD	BD	BDC	GD	HD*
		626	619 622 625 643e												
<b>Keyless</b>															
ND10S	Passage	516	528												
ND40S	Privacy	594	606												
ND170	Single dummy	144	150												
<b>Keyed, Single Cylinder</b>															
ND50PD	Entrance/Office	703	715					-75	40	-45	-45	-38	74	22	
ND53PD	Entrance														
ND80PD	Storeroom														
ND80PD EL/ EU	Electrically locked or unlocked	942	954												
ND96PD EL/ EU	Vandgard® Electrically locked or unlocked	1,034	1,046												

\* Temporary cores (TD and HD options) require non-refundable core handling charge (50-231) of \$12.00 and will be added to the price of the lock. All electrified functions are compatible with the Allegion Connect harnesses. For additional options, including competitive cores, please see the Schlage Mechanical Price Book

## ND Levers - Options

### Latches

Part Number	Backset - Description	Lock Adjustment
<b>Spring Latch*</b>		
13-248	2 3/4" - Square corner, 1 1/8" x 2 1/4"	N/C
<b>Deadlatch*</b>		
14-047	2 3/8" - Square corner, 1 1/8" x 2 1/4"	-36.60
14-048	2 3/8" - Square corner, 1 x 2 1/4"	-36.60
13-247	2 3/4" - Square corner, 1- 1/8" x 2 1/4"	N/C

\* All latch extensions require reinforcement when used in hollow metal door applications

### Strikes

Part Number	Lip Length - Description	Lock Adjustment
10-013	1 1/8" - Square corner, T-strike, box, 1 1/8" x 2 3/4"	N/C
	1 1/2" - Square corner, T-strike, box, 1 1/8" x 2 3/4"	N/C
10-016	1 1/8" - Square corner, T-strike, deep box, fire door latch	N/C
10-025	1 3/16" - ANSI, no box, 1 1/4" x 4 7/8"	N/C
	1 3/8" - ANSI, no box, 1 1/4" x 4 7/8"	+33.60
	1 1/2" - ANSI, no box, 1 1/4" x 4 7/8"	+33.60
K510-066	Box for ANSI strike, must be specified	N/C

### Non-Standard Door Thickness\*

Description	Specify	Lock Adjustment
1 3/8" thick doors - 2 chassis spacers (XN12-012) required; see ND-18	Door thickness and how door is extended.	+65.30

\* If not specified orders will default to EE; RX and Competitor Cores options need to be ordered via RFQ

Shaded items are standard components and are furnished with locks unless otherwise specified.

**ALX - Functions**

ANSI/BHMA Certified A156.2-2011, Series 4000, Grade 2, UL Listed for 3-hour fire door.

**Non-Keyed Locks**

SCHLAGE ANSI

**ALX10 F75**

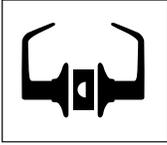

**Passage Latch**

No cylinder; plain lever both sides; spring latch. Both levers always unlocked.

**ALX40 F76**

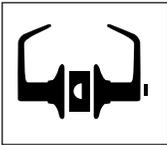

**Bath/Bedroom Privacy Lock**

No cylinder; coin turn outside; pushbutton inside; spring latch. Inside push button locks outside lever. Turn inside lever or close door to release button and prevent lock-out; outside coin turn provides emergency access. Field selectable Vandlgard® feature. Inside lever is always free for immediate egress.

**ALX170**

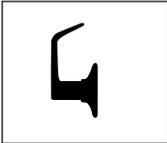

**Single Dummy Trim**

No cylinder; rigid plain lever outside; no hardware inside; no latch. Use as door pull or matching inactive trim.

**Keyed Locks**

SCHLAGE ANSI

**ALX50 F82**

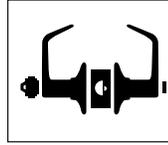

**Entrance/Office Lock**

Cylinder outside; push button inside; deadlatch. Inside push button locks outside lever. Unlock with key or by rotating inside lever. Field selectable Vandlgard feature. Inside lever always free for immediate egress.

**ALX53 F109**

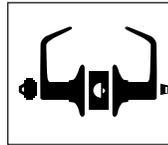

**Entrance Lock**

Cylinder outside; push/turn button inside; deadlatch. Inside button locks outside lever by pushing button or pushing and turning button. Pushed button: unlock with key or by rotating inside lever. Push/turn button: key retracts latch only; unlock by returning button to home position then use key or rotate inside lever. Field selectable Vandlgard feature. Inside lever always free for immediate egress.

**ALX70 F84**

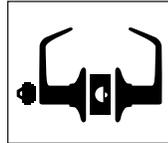

**Classroom Lock**

Cylinder outside; plain lever inside; deadlatch. Key locks or unlocks outside lever. Field selectable Vandlgard feature. Inside lever always free for immediate egress.

**ALX80 F86**

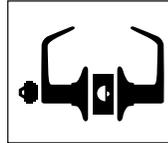

**Storeroom Lock**

Cylinder outside; plain lever inside; deadlatch. Outside lever always locked. Key retracts the latch. Field selectable Vandlgard feature. Inside lever always free for immediate egress.

**Lever:** ATH - Athens  
**Rose:** Rhodes

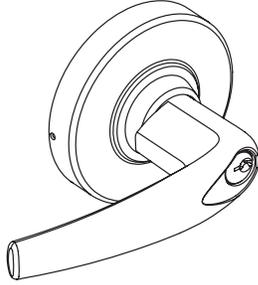

**Lever Grade:** 1  
**Cores:** KIL, FSIC, SFIC, L-SAR, L-CO6, J-SAR, J-CO6

**Lever:** OME - Omega  
**Rose:** Omega

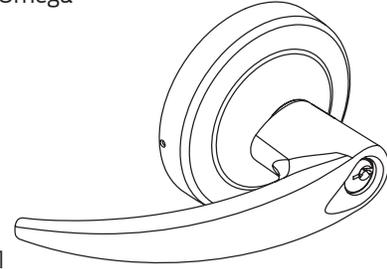

**Lever Grade:** 1  
**Cores:** KIL, FSIC, SFIC

**Lever:** BRW - Broadway  
**Rose:** Rhodes

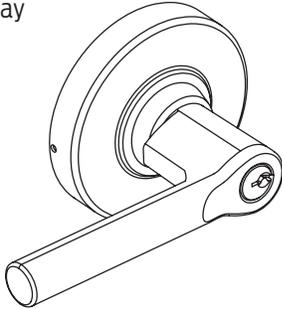

**Lever Grade:** 1  
**Cores:** KIL, FSIC, SFIC

**Lever:** RHO - Rhodes  
**Rose:** Rhodes

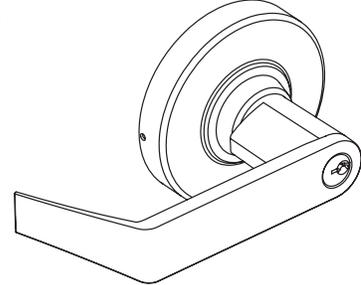

**Lever Grade:** 1  
**Cores:** KIL, FSIC, SFIC, L-SAR, L-CO6, J-SAR, J-CO6, J-CO7

**Lever:** BRK - Boardwalk  
**Rose:** Rhodes

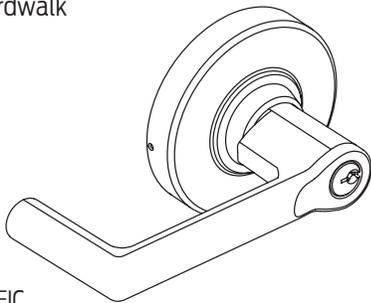

**Lever Grade:** 1  
**Cores:** KIL, FSIC, SFIC

**Lever:** SAT - Saturn  
**Rose:** Rhodes

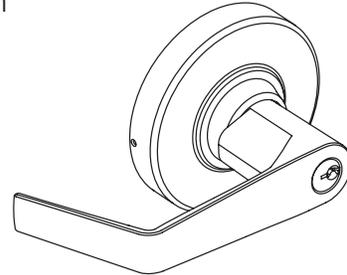

**Lever Grade:** 2  
**Cores:** KIL

**Lever:** LAT - Latitude  
**Rose:** Rhodes

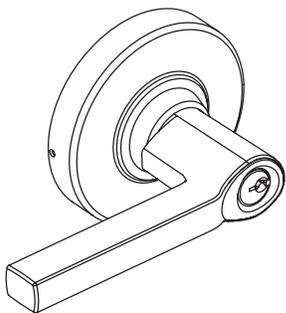

**Lever Grade:** 1  
**Cores:** KIL, FSIC, SFIC

**Lever:** SPA - Sparta  
**Rose:** Rhodes

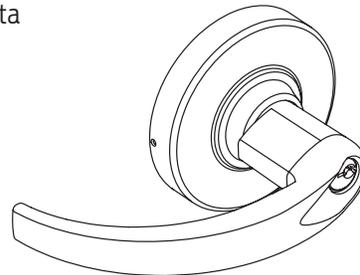

**Lever Grade:** 1  
**Cores:** KIL, FSIC, SFIC, L-SAR, L-CO6, J-SAR, J-CO6

**Lever:** LON - Longitude  
**Rose:** Rhodes

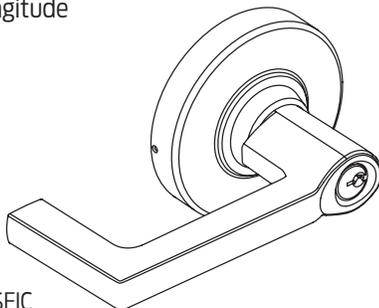

**Lever Grade:** 1  
**Cores:** KIL, FSIC, SFIC

**Lever:** TLR - Tubular  
**Rose:** Rhodes

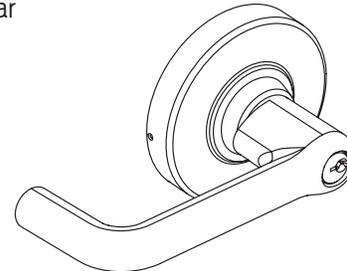

**Lever Grade:** 1  
**Cores:** KIL, FSIC, SFIC, L-SAR, L-CO6, J-SAR, J-CO6



**ALX - Complete Locks**

Function	Description	Designs and Finishes		PRIMARY CYLINDER ADJUSTMENTS AVAILABLE LEVERS AVAILABLE FINISHES							
		SAT	ATH BRW BRK LAT LON OME RHO SPA TLR	L	R	J	B	BDC	G	H*	
		626	619 622 625 643e								
<b>Keyless</b>											
ALX10	Passage	215/227	237 /249								
ALX40	Privacy	244 / 256	266 / 278	ALL	ATH BRW BRK LAT LON OME RHO SPA TLR						
ALX170	Single dummy	133 / 139	144 / 150								
<b>Keyed, Single Cylinder</b>				L	R	J	B	BDC	G	H	
ALX50P/P6	Entrance/Office	312 / 324	334 / 336	-75	40	-45	-45	-38	74	22	
ALX53P/P6	Entrance										
ALX70P/P6	Classroom										
ALX80P/P6	Storeroom										

\* Temporary cores (TD and HD options) require non-refundable core handling charge (50-231) of \$12.00 and will be added to the price of the lock.

**Latches**

Part Number	Backset - Hsg Dia - Description	Lock Adjustment
<b>Spring Latch</b>		
47273621	2 3/8" - 7/8" - Square corner, 1" x 2 1/4"	N/C
47273622	2 3/8" - 7/8" - 1/4" Radius round corner, 1" x 2 1/4"	
47273615	2 3/4" - 7/8" - Square corner, 1" x 2 1/4"	
47273616	2 3/4" - 7/8" - 1/4" Radius round corner, 1" x 2 1/4"	
47273614	2 3/4" - 1" - Square corner, 1 1/8" x 2 1/4"	
<b>Deadlatch</b>		
47273624	2 3/8" - 7/8" - Square corner, 1" x 2 1/4"	N/C
47273625	2 3/8" - 7/8" - 1/4" Radius round corner, 1" x 2 1/4"	
47273618	2 3/4" - 7/8" - Square corner, 1" x 2 1/4"	
47273619	2 3/4" - 7/8" - 1/4" Radius round corner, 1" x 2 1/4"	
47273617	2 3/4" - 1" - Square corner, 1 1/8" x 2 1/4"	

**Strikes**

Part Number	Lip Length - Description	Lock Adjustment
10-013	1 1/8" - Square corner, T-strike, box, 1 1/8" x 2 3/4"	N/C
	1 1/2" - Square corner, T-strike, box, 1 1/8" x 2 3/4"	N/C
47267101	1 1/8" - 1/4" Radius round corner, T-strike, box, 1 1/8" x 2 3/4"	N/C
10-025	1 3/16" - ANSI, no box, 1-1/4" x 4-7/8"	N/C
	1 3/8" - ANSI, no box, 1-1/4" x 4-7/8"	+33.60
	1 1/2" - ANSI, no box, 1-1/4" x 4-7/8"	
10-026	1 1/8" - Square corner, full lip, no box, 1 5/8" x 2 1/4"	N/C
10-027	1 1/8" - 1/4" Radius round corner, full lip, no box, 1 5/8" x 2 1/4"	
K510-066	Box for ANSI strike, must be specified	

Shaded items are standard components and are furnished with locks unless otherwise specified.

**MA Series - Introduction**

### Product Identification

**MA 501 P D**

- Latch Suffix**  
**D** = Deadlatch
- Cylinder Suffix**  
**B** = Less SFIC  
**BDC** = SFIC Construction Core (disposable)  
**BB6** = SFIC - 6 Pin BEST capping  
**BB7** = SFIC - 7 Pin BEST capping  
**G6** = SFIC - 6 Pin slide capping (Falcon only)  
**G7** = SFIC - 7 Pin slide capping (Falcon only)  
**H** = SFIC Construction Core (refundable)  
**L** = Less Conventional, 6 Pin  
**P** = Conventional, 6 Pin/Keyed 5  
**P6** = Conventional, 6 pin  
**P7** = Conventional, 7 pin
- Function**  
 See 63
- Lock Series**

SFIC = Small Format (Best® Style) Interchangeable Core

### Finish Codes and Descriptions

Code		Description
619	(US15)	Satin Nickel
622	(US19)	Matte Black
625	(US26)	Bright Chrome
626	(US26D)	Satin Chrome
630	(US32D)	Satin Stainless Steel
643E	(US11)	Aged Bronze

### Standard Features - Furnished unless otherwise specified



Certification	ANSI A156.13, Series 1000, Grade 1 Operation and Security, UL Listed for 3-Hour fire door with SFIC Interchangeable Core Cylinders: Grade 3 Security
Latch	2 piece stainless steel anti-friction bolt 3/4" projection.
Strike	1 1/4" x 4 7/8", ANSI, Square corner, with dust box
Cylinder	6-Pin, Solid brass, Keyed 5-Pin, Falcon G keyway, Keyed different (KD)
Door Range	1 3/4" - 1 7/8" standard
Keys	Two, Nickel silver cut keys per lock, Falcon G keyway

MA Series - Functions

ANSI A156.13 Series 1000 Grade 1 Operation  
Mortise

FALCON ANSI

MA101 F01



**Passage/Closet Latchset**

Latchbolt retracted by knob/lever from either side at all times. Inside knob/lever is always free for immediate egress.

MA301 F02



**Privacy Lock**

Latch bolt operated by knobs/levers either side, dead bolt operated by turn from inside or by emergency release outside. Available with messaging indicator. Please specify.

MA441 F32



**Classroom Security Lock**

Latch bolt operated by knob/lever from either side except when outside knob/lever is locked from inside or outside by key. When outside knob/lever is locked, latch bolt is retracted by key from inside or outside or by operating inside knob/lever. Auxiliary dead latch. Inside knob/lever is always free for immediate egress. Available with messaging indicator. Please specify.

MA521 F04



**Entry/Office Lock**

Latch bolt operated by knob/lever from either side except when outside knob/lever is made inoperative by buttons in face. When outside knob/lever is locked, latch bolt is retracted by key from outside or by operating inside knob/lever. Auxiliary dead latch. Inside knob/lever is always free for immediate egress.

MA531 F20



**Apartment Corridor Door Lock**

Latch bolt operated by knob/lever from either side, except when outside knob/lever is made inoperative by buttons in face. Dead bolt operated by key outside or turn inside. Key outside operates both bolts. Operating inside knob/lever retracts both bolts and outside remains locked. Latch bolt is deadlocked when outside knob/lever is made inoperative or when the dead bolt is projected. When dead bolt is retracted, knob/lever is unlocked by buttons in face. Inside knob/lever is always free for immediate egress.

Mortise

FALCON ANSI

MA561 F05



**Classroom Lock**

Latchbolt operated by knob/lever from either side except when outside knob/lever is locked by key. When outside knob/lever is locked, latchbolt is retracted by key from outside or by operating inside knob/lever. Auxiliary latch deadlocks latchbolt when door is closed. Inside knob/lever is always free for immediate egress.

MA571 F13



**Dormitory or Exit Lock**

Latch bolt operated by knob/lever from either side. Dead bolt projected by key from outside and turn from inside. Operating inside knob/lever retracts both bolts and unlocks outside. Inside knob/lever is always free for immediate egress. Available with messaging indicator. Please specify.

MA581 F07



**Storeroom Lock**

Latch bolt operated by key from outside or by operating inside knob/lever. Outside knob/lever is always inoperative. Auxiliary dead latch. Inside knob/lever is always free for immediate egress.

**MA-Series - Complete Locks**

Grade 1 Mortise Locks with Cast/Forged or Heavy Wrought Trim  
ANSI-A156.13, SERIES 1000, GRADE 1

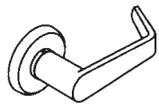

**DG (Dane-Gala)**



**AG (Avalon-Gala)**

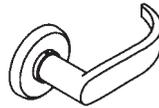

**QG (Quantum-Gala\*)**

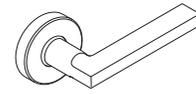

**LTG (Latitude-Gala\*)**

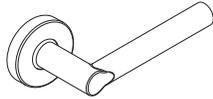

**BRG (Broadway-Gala)**

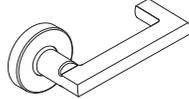

**LGG (Longitude-Gala)**

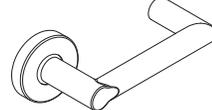

**BOG (Boardwalk-Gala)**

**MA Lever/Rose Styles**

Function	Description	Designs and Finishes	
		DG, AG, QG, LTG, BRG, LGG, BOG	
		626 643E	619 622 625 630*
<b>Single Cylinder Functions</b>			
MA521P	Entry/Office	\$670.00	\$682.00
MA561P	Classroom		
MA571P	Dormitory Exit		
MA581P	Storeroom		
MA531P	Apartment Corridor	692.00	704.00
<b>Double Cylinder Functions</b>			
MA441P	Classroom Security	737.00	749.00
<b>CAUTION:</b> Double cylinder locks on residences and any door in any structure which is used for egress are a life safety hazard in times of emergency and their use is not recommended. Installation should be in accordance with existing codes only.			
<b>Non-Keyed Functions</b>			
MA101	Passage	\$523.00	\$535.00
MA301	Privacy	603.00	615.00

**Note:** 1) Specify 12 or 24VDC. Default is 12V.  
Power supply PS902 will be sufficient to operate an individual lock for multiple lock installation - see Power Supply section.

\* Latitude, Longitude, Broadway and Boardwalk levers not available in 630 finish.



**MA-Series - Complete Locks**

Grade 1 Mortise Locks with Cast/Forged or Heavy Wrought Trim ANSI-A156.13, SERIES 1000, GRADE 1



AN (Avalon-Napa)



DN (Dane-Napa)

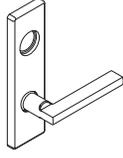

LTN (Latitude-Napa\*)

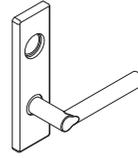

BRN (Broadway-Napa\*)



QN (Quantum-Napa)

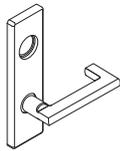

LGN (Longitude-Napa\*)

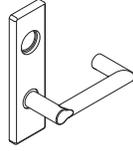

BON (Boardwalk-Napa\*)

**MA Lever Escutcheon Styles**

Function	Description	Designs and Finishes			
		DN, AN, QN, LTN, BRN, LGN, BON			
		626	643E	619	622 625 630*
<b>Single Cylinder Functions</b>					
MA521P	Entry/Office	\$720.00		\$732.00	
MA561P	Classroom				
MA571P	Dormitory Exit				
MA581P	Storeroom	741.00		753.00	
MA531P	Apartment Corridor				
<b>Double Cylinder Functions</b>					
MA441P	Classroom Security	\$787.00		\$799.00	
<b>CAUTION:</b> Double cylinder locks on residences and any door in any structure which is used for egress are a life safety hazard in times of emergency and their use is not recommended. Installation should be in accordance with existing codes only.					
<b>Non-Keyed Functions</b>					
MA101	Passage	\$572.00		\$584.00	
MA301	Privacy	652.00		664.00	

**Note:** 1) Specify 12 or 24VDC. Default is 12V.  
Power supply PS902 will be sufficient to operate an individual lock for multiple lock installation - see Power Supply section.

\* Latitude, Longitude, Broadway and Boardwalk levers not available in 630 finish.



T Series • Functions

ANSI A156.2 Series 4000 Grade 1

Key-In-Lever Locks

FALCON ANSI

T101 F75

**Passage/Closet Latchset**

Latch bolt by levers at all times.



Key-In-Lever Locks

FALCON ANSI

T561 F84

**Classroom Lock**

Deadlocking latch bolt by levers. Outside lever is locked by key in outside lever. Inside lever is always free.



T301 F76

**Privacy Lock**

Latch bolt by levers. Outside lever locked by push button in inside lever. Rotating inside lever or closing door releases push button. Emergency release in outside lever unlocks door.



T581 F86

**Storeroom Lock**

Deadlocking latch bolt by lever inside or key outside. Outside lever is inoperable. Inside lever always free.



T381 F88

**Classroom Security Lock**

Latchbolt operated by lever from either side except when key from inside lever locks outside lever. When outside lever is locked, latchbolt retracted by key in outside lever or by turning inside lever.



T12

**Dummy Trim**

Single Trim-surface mounted rigid lever.



T511 F109

**Entry/Office Lock**

Turn/push button locking. Pushing and turning button locks outside lever requiring use of key until button is manually unlocked. Push button locking. Pushing button locks outside lever until unlocked by key or by rotating inside lever. Inside lever always free. Deadlocking latch bolt.



\* **Caution:** Double cylinder locks on residences and any door, in any structure, which is used for egress are a life safety hazard in times of emergency and their use is not recommended. Installation should be in accordance with existing codes only.

**T Series - Complete Locks**

**Grade 1 Extra Heavy Duty Cylindrical Locksets  
ANSI-A156.2, SERIES 4000, GRADE 1**

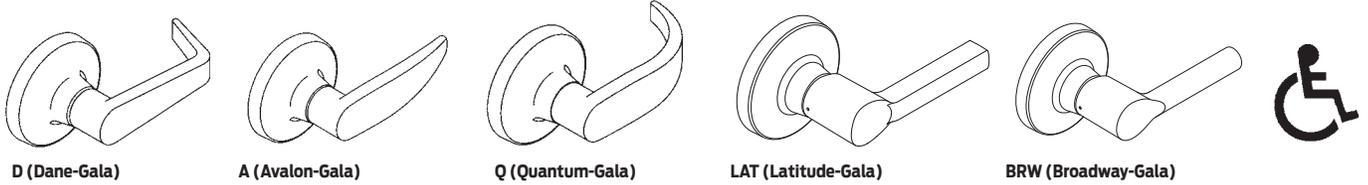

**Key-In-Lever**

Function	Description	Designs and Finishes		
		D, A, Q, LAT, BRW		
		626	643E	619 622 625
<b>Single Cylinder Functions</b>				
T351PD	Closet	\$504.00		\$516.00
T511PD	Entry/Office			
T561PD	Classroom			
T581PD	Storeroom			
<b>Double Cylinder Functions</b>				
T381PD	Exit Security	589.00		601.00
<b>CAUTION:</b> Double cylinder locks on residences and any door in any structure which is used for egress are a life safety hazard in times of emergency and their use is not recommended. Installation should be in accordance with existing codes only.				
<b>Non-Keyed Functions</b>				
T101S	Passage	\$360.00		\$372.00
T301S	Privacy	452.00		464.00
<b>Dummy Trim</b>				
T12	Half Dummy	\$160.00		\$166.00

**Notes:** 1) 24V is standard. Power supply PS902 will be sufficient to operate an individual lock for multiple lock installation - see Power Supply section.

**W Series - Introduction**

**Product Identification**

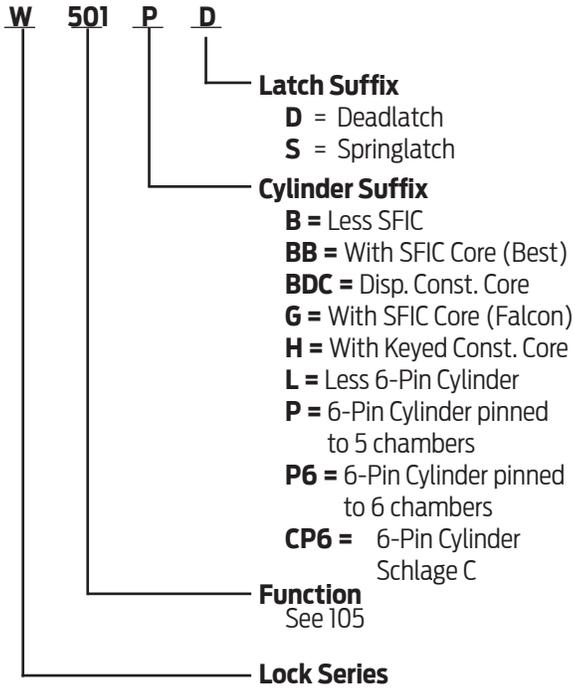

SFIC = Small Format (Best® Style) Interchangeable Core

**Finish Codes and Descriptions**

Code		Description
619	(US15)	Satin Nickel
622	(US19)	Matte Black
625	(US26)	Bright Chrome
626	(US26D)	Satin Chrome
643E	(US11)	Aged Bronze

**Standard Features** - Furnished unless otherwise specified



Certification	ANSI A156.2, Series 4000, Grade 2, UL Listed for 3-Hour fire door
Latch	1 1/8" x 2 1/4", Square corner faceplate, 1" housing diameter, 1/2" throw, 2 3/4" backset
Strike	1 1/4" x 4 7/8", ANSI, Square corner, no box
Cylinder	6-Pin, Solid brass, keyed 5-pin, Falcon G keyway, Keyed different (KD)
Door Range	1 3/8" - 1 3/4" standard
Keys	Two, Nickel silver cut keys per lock, Falcon G keyway

**W Series • Functions**

**ANSI A156.2, Series 4000 Grade 2**

**Key-In-Lever Locks**

FALCON ANSI &  
Function

**W101 F75**

**Passage Latchset**

Latch bolt by levers at all times.



**W161 F111**

**Communicating/Exit Latch**

Deadlocking latch bolt by inside lever. Non-removable blank plate outside.



**W301 F76**

**Privacy Lock**

Latch bolt by levers. Outside lever is locked by push button in inside lever. Rotating inside lever or closing door release push button and frees outside lever. Inside lever is always free. Emergency release in outside lever unlocks door.



**W511 F109**

**Entry/Office Lock**

Deadlocking latch bolt by levers. Turn/push button locking. Pushing and turning button locks outside lever, requiring use of a key for unlocking the door until button is manually unlocked. Pushing button locks outside lever until unlocked by key or by rotating inside lever. Inside lever is always free.



**Key-In-Lever Locks**

FALCON ANSI &  
Function

**W561 F84**

**Classroom Lock**

Deadlocking latch bolt by levers. Outside lever is locked by key in outside lever. Inside lever is always free.



**W581 F86**

**Storeroom Lock**

Deadlocking latch bolt by lever inside or key outside. Outside lever is always locked. Inside lever is always free.



**W12/W18\***

**Dummy Trim**

Single or double available. Single (W12) Double (W18)



\* Functions are not available for small rose option

**W Series - Complete Locks**

Grade 2 Cylindrical Lockset  
ANSI-A156.2, SERIES 4000, GRADE 2

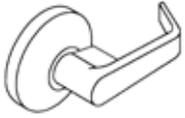

D (Dane)

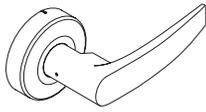

A (Avalon)



Q (Quantum)

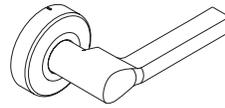

LAT (Latitude)

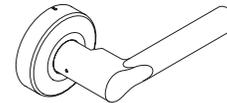

BRW (Broadway)



**Key-In-Lever Large Rose 3 3/8" Rose**

Function	Description	Designs and Finishes	
		D, A, Q, LAT, BRW	
		626 643E	619 622 625
<b>Single Cylinder Functions</b>			
W501PD	Entry	\$134.00	\$146.00
W511PD	Entry/Office		
W561PD	Classroom		
W571PD	Dormitory/Corridor		
W581PD	Storeroom		
W711PD	Apartment Entry		
<b>Non-Keyed Functions</b>			
W101S	Passage	121.00	133.00
W161D	Communicating/Exit	122.00	134.00
W201D	Patio		
W301S	Privacy		
<b>Dummy Trim</b>			
W12	Half Dummy	\$72.00	\$78.00
W18	Two Sided Dummy	142.00	154.00

Note: 1) New Finishes (643E, 619, 622) & New Levers (AVA, LAT, LON, BRW, BRK) are not available on W18 function.



ELI (Elite)

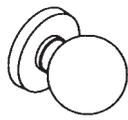

HAN (Hana)

**Key-In-Knob**

Function	Description	Designs and Finishes			
		E H			
		626	605	606	613 625
<b>Single Cylinder Functions</b>					
W511PD	Entry/Office	\$77.00			\$89.00
W561PD	Classroom				
W571PD	Corridor				
W581PD	Storeroom				
W711PD	Apartment Entry				
<b>Non-Keyed Functions</b>					
W101S	Passage	\$64.00			\$76.00
W301S	Privacy	65.00			77.00
<b>Dummy Trim</b>					
W12	Half Dummy	\$47.00			\$53.00

Note: 2) Not available with a small rose. Small rose option is for levers only.

**W-Series Small Rose - Levers Complete Locks**

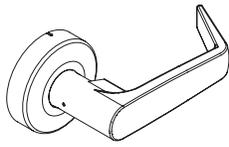

SRD (Dane)

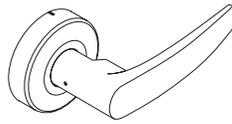

SRA (Avalon)

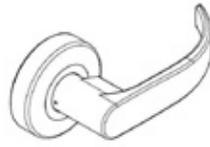

SRQ (Quantum)

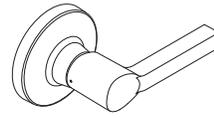

SRLA (Latitude)

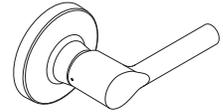

SRBR (Broadway)

**Small Rose 2 9/16" (65mm)**

Function	Description	Designs and Finishes	
		SRD, SRA, SRQ, SRLAT, SRBR	
		626 643E	619 622 625
<b>Single Cylinder Functions</b>			
W511	Entry/Office	\$160.00	\$172.00
W561	Classroom		
W581	Storeroom		
<b>Non-Keyed Functions</b>			
W101	Passage	131.00	143.00
W161	Communicating/Exit	134.00	146.00
W301	Privacy		
<b>Dummy Trim</b>			
W12	Single Dummy	76.00	82.00

**How to Order the Small Rose Option**

**Small Rose 2 9/16" (65mm)**

Function	Cylinder	Trim	Finish
W511	PD	SRD	626

D200 Series - Introduction

**Product Identification**

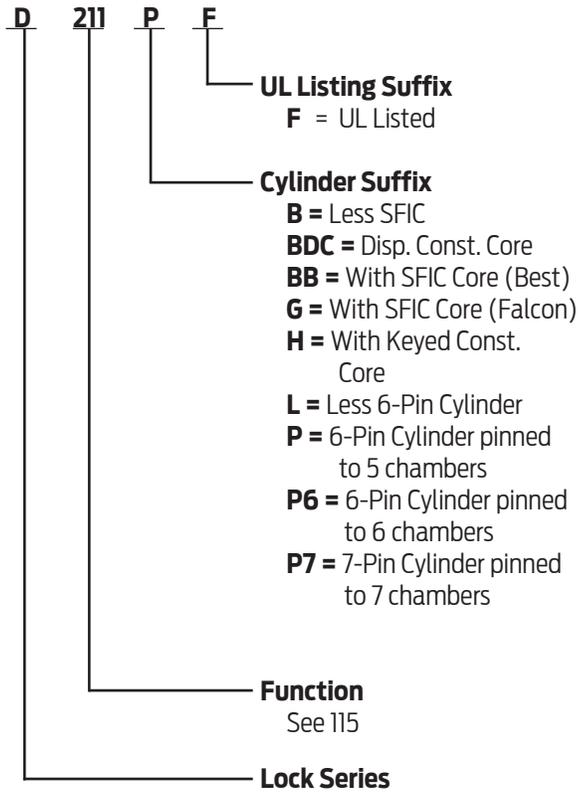

SFIC = Small Format (Best® Style) Interchangeable Core

**Finish Codes and Descriptions**

Code		Description
619	(US15)	Satin Nickel
622	(US19)	Matte Black
625	(US26)	Bright Chrome
626	(US26D)	Satin Chrome
643E	(US11)	Aged Bronze

**Standard Features** - Furnished unless otherwise specified

Certification	BHMA - ANSI A156.5, 2001, Grade 2 auxiliary lock, Available UL Listed for 3-Hour fire door
Deadbolt	1 1/8" x 2 1/4", Square corner faceplate, 1" housing diameter, 1" throw
Strike	1 1/8" x 2 3/4", lipless, with box
Cylinder	6-Pin, Solid brass, Keyed 5-Pin, Falcon G keyway, Keyed different (KD)
Door Range	1 3/8" - 2 1/4" standard cylinder or thumbturn only; 1 5/8" - 2" interchangeable core cylinder
Keys	Two, Nickel silver cut keys per lock, Falcon G keyway
Reinforcement	Metal dust box reinforcer with three - 3" screws
Trim Ring	1" Wrought brass or bronze, reinforced with security insert
Backset	2 3/8" and 2 3/4" adjustable



**D200 Series • Functions**

**BHMA / ANSI A156.5, 2001, Grade 2  
Bored Deadbolt Locks**

FALCON ANSI &  
Function

**D211P E0172**

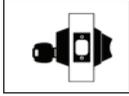

**Classroom Function**

Deadbolt thrown or retracted by key from outside. Inside turn will only retract bolt. Bolt automatically deadlocks when fully thrown.

**D241P E0152**



**Single Cylinder x Turn**

Deadbolt thrown or retracted by key or by turn. Bolt automatically deadlocks when fully thrown.

**D261 E0192**



**Thumbturn, Inside Only**

Deadbolt thrown or retracted by turn unit only. No outside trim. Bolt automatically deadlocks when fully thrown.

**BHMA / ANSI A156.5, 2001, Grade 2  
Bored Deadbolt Locks**

FALCON ANSI &  
Function

**D261M E01112**



**Thumbturn, Inside x Rose**

Deadbolt thrown or retracted by turn unit only. Outside blank rose. Bolt automatically deadlocks when fully thrown.

**D271**



**Thumbturn x Occupancy Indicator**

Deadbolt thrown or retracted by turn unit only. Occupancy indicator on outside (reads either in use or vacant with color coding). Bolt automatically deadlocks when fully thrown.

**Note:** This function is not UL Listed.

**\* Caution:** Double cylinder locks on residences and any door, in any structure, which is used for egress are a life safety hazard in times of emergency and their use is not recommended. Installation should be in accordance with existing codes only.

**D200-Series • Complete Locks**



Outside Cylinder Trim

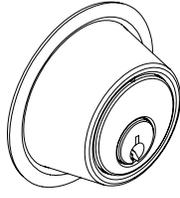

Inside Cylinder Trim



Rose and Turn



**D-200 Series**

Function	Description	Designs and Finishes				
		626	619	622	613	625 643e
<b>Keyless</b>						
D261	Turn, Inside Only	\$65.00	\$71.00			
D261M	Turn, Inside x Rose					
D271	Turn, Inside x Occupancy Indicator	66.00	72.00			
<b>Single Cylinder Functions</b>						
D211P	Classroom Function	\$87.00	\$93.00			
D241P	Single Cylinder x Turn	84.00	90.00			

- Notes:** 1) Split finishes are priced at the highest finish price.  
 2) D271 Occupancy Indicator deadbolt is shipped with emergency key (61-509) and instructions.  
 3) 'F' Suffix must be added for UL product

**H2 Series - Introduction**

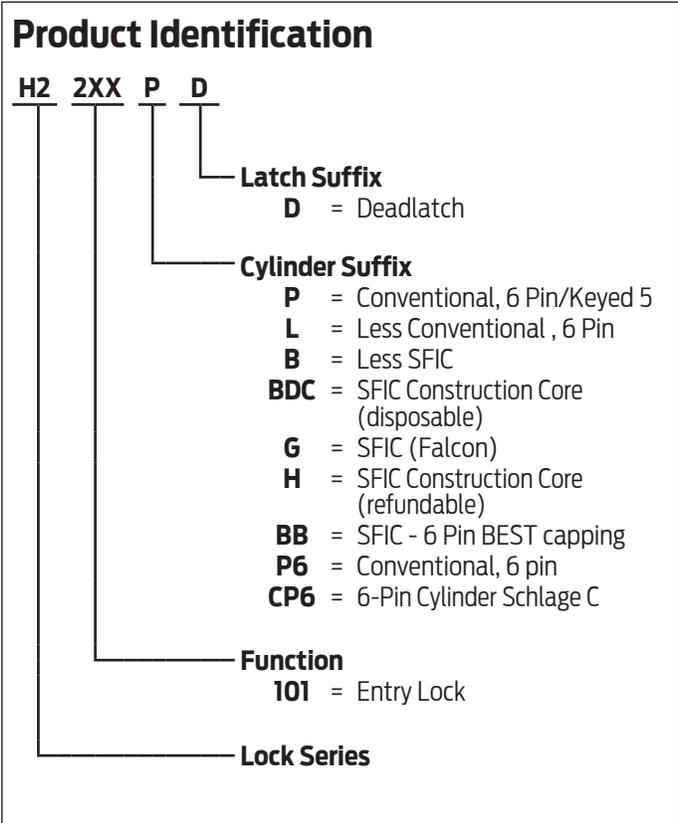

### Finish Codes and Descriptions

Code		Description
619	(US15)	Satin Nickel
622	(US19)	Matte Black
625	(US26)	Bright Chrome
626	(US26D)	Satin Chrome
643E	(US11)	Aged Bronze

### Standard Features



Certification:	ANSI/BHMA Certified A156.12-2013, Grade 2, UL listed for 3-hour fire door With SFIC interchangeable core cylinders: Grade 3 Security
Deadbolt:	1 X 2 1/4", dual option faceplate, (square corner standard, round corner included in package), 1" housing diameter, 1" throw
Latch	1" x 2 1/4" dual option faceplate (square corner standard, round corner included in package). 1" edge bore required
Strikes:	1 1/8" x 2 3/4", Square corner (deadbolt) and 1 5/8" x 2 1/4", Square corner, T-strike, box, 1 1/8" x 2 3/4" (Deadlatch)
Backset:	Adjustable backset, fits 2 3/8" or 2 3/4"
Cylinders:	6-pin, solid brass, keyed 6-pin, G keyway, keyed different (KD)
Door Range:	1 3/4" to 2" standard (1 3/8" available, must be specified)
Keys:	Nickel silver cut keys, 6-pin, G keyway
Center to Center:	Fits 4" or 5 1/2" (factory default) center to center door preps

**H2 Series - Functions**

**BHMA / ANSI A156.5, 2001, Grade 2  
Bored Deadbolt Locks**

FALCON ANSI

**H2101 F95**

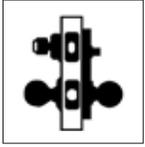

**Entrance Lock**

Deadbolt operated by key from outside or by turn unit from inside. Bolt automatically deadlocks when fully thrown. Latch retracted by lever from either side. Turning inside lever retracts deadbolt and latch simultaneously for immediate exit.

FALCON ANSI

**H2171**

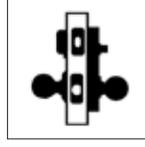

**Public Restroom Lock  
with Occupancy Indicator**

Latchbolt retracted by lever from either side. Deadbolt thrown or retracted by turn inside or retracted by emergency key outside. Rotating turn from inside extends deadbolt and changes visual message on outside from vacant to occupied. Inside lever simultaneously retracts deadbolt and latch.

**H2 Series - Complete Locks**



**Dane (DAN)**



**Avalon (AVA)**



**Quantum (QUA)**

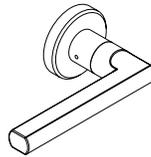

**Latitude (LAT)**



**Broadway (BRW)**

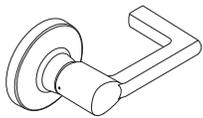

**Boardwalk (BRK)**

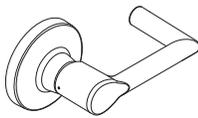

**Longitude (LON)**

Function	Description	Design and Finishes		
		DAN, AVA, QUA, LAT, LON, BRW, BRK		
Keyed, Single Cylinder		626	643E	619 622 625
H2101	Entrance Lock - Deadbolt Single Cylinder	\$342.00		\$354.00
H2171	Public Restroom with Occupancy Indicator - No Cylinder (Interior Locking Only)	452.00		464.00

Specify both outside and inside designs if split.

**Cylinders**

**Finish Codes and Descriptions**

<b>Code</b>		<b>Description</b>
619	(US15)	Satin Nickel
622	(US19)	Matte Black
626	(US26D)	Satin Chrome
643E	(US11)	Aged Bronze

**Standard Features** - Furnished unless otherwise specified



**Standard Cylinder**      Solid Brass housings and plugs. Standard Keyway is Falcon G keyway. Keyed different furnished unless otherwise specified (additional charges may apply, See page 140 for keying charges) with 2 nickel silver keys. Mortise cylinder standard lengths are 1 1/8" for conventional cylinders and 1 3/8" for small format interchangeable core housings.

SFIC Furnished in A keyway unless otherwise specified. Combined cores are provided with 2 keys.

**Restricted Keyways**      Falcon has a varied selection of restricted keyways for conventional and SFIC cylinders based on geographic restrictions for usage. Minimum cylinder purchase required. See your Security and Safety Consultant for more information or availability.

**Conventional Cylinders**

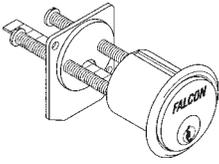

**951**  
Available in:  
619, 622, 626, 643e

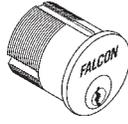

**985**  
Available in:  
619, 622, 626, 643e



Non-IC Products

**MA and M Series Conventional Rim and Mortise Cylinders**

Pins	Length	Description	Number	626 643e	619, 622
5 or 6	1 1/8	Mortise	985	\$71.00	\$75.00
	1 1/4		986		
5, 6, or 7	-	Rim	951	71.00	75.00

- Notes:** 1) MA cam (5622-STD) provided.  
 2) Mortise and rim cylinders are not available in any competitor keyway, except Schlage C.  
 3) Conventional mortise cylinder with Schlage C keyway are available with 985, 986 and 951.

**Interchangeable Cores**

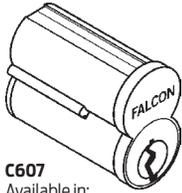

**C607**  
Available in:  
605, 606, 613, 625, 622, 626, 643e

**Regular Core (suffix keyway to number)**

Description	Uncombined			Combined		
	6-Pin	7-Pin	Price	6-Pin	7-Pin	Price
Standard	C646	C647	\$37.00	C606	C607	\$50.00
Best style capping	CB846	CB847		CB806	CB807	
No logo	C648	C649	37.00	C608	C609	
No logo, Best capping	CB848	CB849		CB808	CB809	

- Notes:** 1) For restricted keyways add \$12.30 per core. See page iv for restricted keyway policies.  
 2) For temporary construction cores and policy, See page MF-59.  
 3) For 605, 613 and 625 add \$3.00 per core. Minimum 250 pieces.  
 4) Keying must be specified on combined cores.

**Pricing:** Uncombined cores have no pins, springs or keys. Combined core prices include master keying.  
**Finishes:** 606 and 626 standard.  
**Packaging:** Uncombined cores are packed 20 per box.  
**Keyways:** The "A" keyway is standard for IC products and will be supplied unless otherwise specified. A, B, C, D, DD, E, F, G, H, J, K, L, M, N, Q, R, TB and TD are equivalent to Best and Arrow IC keyways of the same letter designations. All other keyways are restricted. Add \$12.30 list for all restricted keyways.  
**Logo:** Cores and keys are supplied with the Falcon logo standard. Combined cores supplied without logo are furnished with plain (non-embossed) keys.

**IC Cylinders**

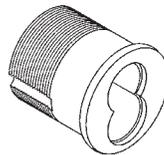
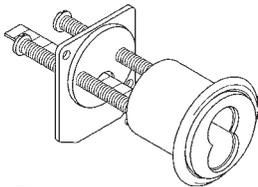

**Rim**  
Available in:  
619, 622, 626, 643e

**Mortise**  
Available in:  
619, 622, 626, 643e

All prices are less core. Not available with C997.

**Small Format Interchangeable Rim and Mortise Core Housings Only**

Cat. Number	Length	Pins	Description	626 643e	619, 622, 625
C987	1-3/8"	6 or 7	Mortise	\$42.00	\$44.00
C988	1-1/2"	6 or 7	Mortise		
C953	N/A	6 or 7	Rim	45.00	47.00

- Notes:** 1) All mortise cylinders will be furnished with cam 5622-IC.  
 2) When ordering cylinders with construction cores, include the suffix -7 CCA or -6 CCA added to the part number. i.e. C987-6 CCA 626 for a 6 pin small format construction core included with a C987 cylinder in 626 finish

**Conventional Keys and Blanks**

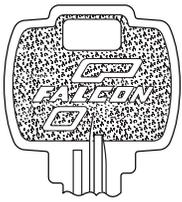

**Standard**

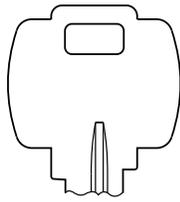

**Plain**  
(non-embossed)



**Large Bow**



**Non-IC Products**

**Key Blanks**

(Specify keyway and order in multiples of 50 except where specified)

Part. Number	Description	Qty./Wt.	Each
KB573	Standard 5-pin	50/1	\$2.80
KB577	Standard 6-pin		
KB581	Standard 7-pin	35/1	3.20
KB751	Plain 5-pin (non-embossed)	50/1	2.90
KB761	Plain 6-pin (non-embossed)		
KB771	Plain 7-pin (non-embossed)	35/1	3.20
KB544	Large bow - 5-pin	25/1	6.10
KB590	Large bow - 6-pin	25/1	7.20
Q330-215	6 Pin Schlage C Blank	1	3.70

**Cut Keys**

Part. Number	Description	Each
KB574	Standard 5 Pin	\$8.40
KB578	Standard 6 Pin	
KB582	Standard 7 Pin	
KB794	Plain 5-pin (non-embossed)	
KB797	Plain 6-pin (non-embossed)	9.20
KB799	Plain 7-pin (non-embossed)	
KB545	Large bow - 5-pin (When furnished with lock - 2 keys) additional per lock	
KB545	Large bow - 5-pin	10.90
KB591	Large bow - 6-pin (When furnished with lock - 2 keys) additional per lock	
KB591	Large bow - 6-pin	8.20
330055	Schlage C - 6 pin	
Q330-276	Schlage Split Key 6-pin	10.90

\* Specify key section to key (blank) numbers.

**Note:** 1) Prices listed for key blanks and cut keys are for E, G and H sections only. For all other key sections add \$0.80 list per key to prices shown. Letter of authorization required for restricted sections; not available to stock; shipped directly to the end user.

**IC Keys and Key Blanks, Disposable Construction Core**

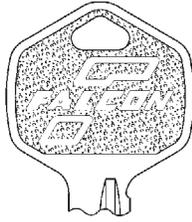

**Standard**

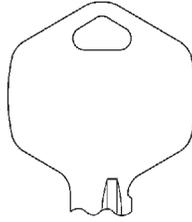

**Plain**  
(non-embossed)

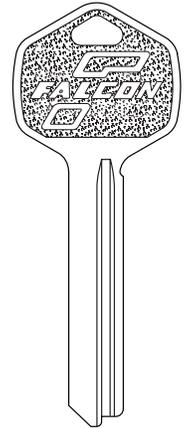

**Standard Key Tip**

**IC Core Key Blanks**

	<b>Standard</b>	<b>Plain Both Sides</b>	<b>Price</b>
Standard	KB628	KB718	\$3.00
Stamped CONTROL	KB608	KB744	5.60

**IC Core Cut Keys**

	<b>Standard</b>		<b>Plain Both Sides</b>		<b>Price</b>
	<b>6-Pin</b>	<b>7-Pin</b>	<b>6-Pin</b>	<b>7-pin</b>	
Standard	KB632-1	KB632-2	KB673-1	KB673-2	\$8.40
CONTROL	KB609-1	KB609-2	KB778-1	KB778-2	10.80

- Notes:** 1) Specify keyway  
 2) Order standard blanks in multiples of 50.  
 3) Prices for key blanks and/or cut keys are for single key sections only. Key blanks 50 min. Cut keys no minimum quantity  
 4) For double milled key (e.g. DE, EF, FG) add \$3.30 each to prices shown, minimum order quantity of 50 keys.  
 5) Triple and quadruple milled keys add \$3.80 each to price shown, minimum order quantity of 50 keys.  
 6) Letter of authorization required for restricted sections; not available to stock; shipped directly to the end user.



**Best Key**

**Best® Style SFIC Core Key Blanks**

	<b>Standard</b>	<b>Plain Both Sides</b>	<b>Price</b>
Standard	KB800*	KB801*	\$3.20

\* KB 800 & 801 are not available in multi milled keyways.

**Best® Style SFIC Core Cut Keys**

	<b>Standard</b>	<b>Plain Both Sides</b>	<b>Price</b>
Standard 6-Pin	KB807-1	KB809-1	\$8.90
Stamped Control 6-Pin	KB811-1	KB813-1	11.60
Standard 7-Pin	KB807-2	KB809-2	13.40
Standard Control 7-Pin	KB811-2	KB813-2	20.70

**Keys & Keying Construction Core Program**

**Construction Core Program**

Keyed construction cores may be ordered with interchangeable core locks and cylinders. These cores may also be ordered separately. All keyed construction cores are assessed a non-refundable handling charge (50-231). Standard payment terms apply.

Features:

- 6-pin A keyway.
- 7-pin A keyway.
- Construction cores are a flat black finish on the face. Other colors may be provided. Contact Customer Service for available colors.
- Construction cores are furnished with no keys (NCK). Cut keys must be ordered separately.
- A control key is required to install and remove construction cores. Control keys must be ordered separately.
- Construction cores may be returned for credit in working condition. Credit is issued upon receipt of cores at our factory.

A Return Material Authorization (RMA) must be issued, in order for cores to be returned.

**Construction Core Program**

Part Number	Description	Specify	Price
C606CCA	Construction core 6-pin	Specify "H" suffix when ordering with Locks, Specify CCA when ordering with Mortise and Rim Cylinders	\$50.00
C607CCA	Construction core 7-pin		
KB632-1CCA	Cut key for construction core 6-pin		8.90
KB632-2CCA	Cut key for construction core 7-pin		
KB609-1CCA	Cut control key 6-pin (order separately)		11.60
KB609-2CCA	Cut control key 7-pin (order separately)		
1408	Disposable construction core	Specify "BDC" suffix when ordering	6.40
50-231F	Non-refundable handling charge per core		8.70

- Notes:**
- 1) Keyed and temporary construction cores will be installed in locks and cylinders automatically unless otherwise specified on orders.
  - 2) Construction cores for a given project are keyed alike to one of a limited number of combinations nationwide. Different Falcon projects in the same area using the same or different contractors may use the same key. Where a higher degree of security is desired, order a set of cores in 626 finish keyed alike to a random combination. Specify "KSI." Such cores are not returnable to Falcon but may be reused for other projects.
  - 3) Temporary construction cores are an inexpensive alternative to interior keyed construction cores. This temporary is intended for use on interior door applications or where security on-site is not a concern.

**Temporary Construction Core Program (Disposable)**

Temporary construction cores may be ordered with interchangeable core locks and cylinders. These cores may also be ordered separately. Standard payment terms apply.

Features:

- Conveniently fits both 6 & 7-pin SFIC applications.
- No keys need to be issued.
- Disposable construction cores are not returnable.
- The disposable core is inserted in the lever or knob and is operated by a thumbturn, which retracts the latch bolt.

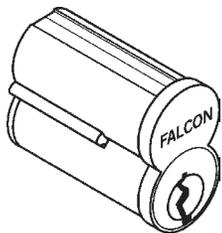

C607CCA

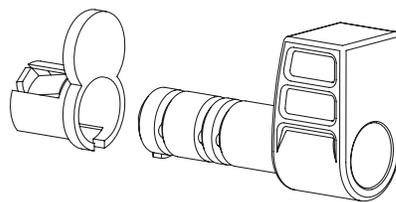

1408

### Exits

#### Von Duprin 22 Series

- UL listed for Panic Exit Hardware
- Devices are ANSI A156.3, 2001 Grade 1 Certified
- Two finishes available: **SP28** = Powder-coated aluminum **SP313** = Powder-coated dark bronze

#### 22 Rim Panic Device

Trim Function	Handing	Finish	Series	3'	4'
				List Price	
Exit Only	-	SP28	22-EO-SP28	\$533.00	\$554.00
Exit Only	-	SP313	22-EO-SP313	533.00	554.00

#### 22-F Rim Fire Exit Hardware

Trim Function	Handing	Finish	Series	3'	4'
				List Price	
Exit Only	-	SP28	22-EO-F-SP28	\$672.00	\$693.00
Exit Only	-	SP313	22-EO-F-SP313	672.00	693.00

#### 2227 Surface Vertical Rod Panic Device

Trim Function	Handing	Finish	Series	Door Height	3'	4'
					List Price	
Exit Only	-	SP28	2227-EO-SP28	7'	\$919.00	\$940.00
Exit Only	-	SP313	2227-EO-SP313	7'	919.00	940.00

#### 2227-F Surface Vertical Rod Fire Exit Hardware

Trim Function	Handing	Finish	Series	Door Height	3'	4'
					List Price	
Exit Only	-	SP28	2227-EO-F-SP28	7'	\$1,201.00	\$1,222.00
Exit Only	-	SP313	2227-EO-F-SP313	7'	1,201.00	1,222.00

**Trim****Von Duprin Series 22 Trim**

- Finishes available:
  - SP28** = Powder-coated aluminum
  - SP313** = Powder-coated dark bronze

**22 Series Trim**

Series	Lever	Handing	Finish	List Price
210-DT	-	-	SP28	\$61.00
210-DT	-	-	SP313	61.00
210-NL	-	-	SP28	70.00
210-NL	-	-	SP313	70.00
230-L	06	LHR	SP28	269.00
230-L	06	RHR	SP28	269.00
230-L	06	LHR	SP313	269.00
230-L	06	RHR	SP313	269.00
230-NL	-	-	SP28	137.00
230-NL	-	-	SP313	137.00
230-DT	-	-	SP28	123.00
230-DT	-	-	SP313	123.00

**Auxiliary Parts**

**Cylinders**

Model No.	Description	Compatible Trim Series	Finish	List Price
3215	Mortise 1 1/4"	230L	US26D	\$106.00
3216	Rim Cylinder	210NL, 230NL	US26D	106.00

**Extension Rods**

Model No.	Description	Finish	List Price
ER-36	36" Extension Rod for 2227	SP28	\$34.00
ER-36	36" Extension Rod for 2227	SP313	34.00

**Sex Bolts**

Model No.	Description	Finish	List Price
325	325 Sex Bolt 1/4 - 20 (pkg of 2)		\$32.00
425	425 Sex Bolt 10-24 (Pkg of 2)		32.00

## Electronics e-Strike

## Electronics e-Strike

Description	Finish	Price Each
4211-US32D-12/24VDC-FSA/FSE	630	\$228.00
4212-US32D-12/24VDC-FSA/FSE	630	274.00
6111 US32D 24VDC FSE	630	1,023.00
6112 US32D 24VDC FSE	630	957.00
6210 US32D 24VDC FSE	630	932.00
6210 US32D 12VDC FSE	630	932.00
6210 US32D 24VDC FSE DS	630	1,164.00
6210 US32D 24VDC FS	630	979.00
6211 FSE (MORT/CYL) 24VDC 630	630	878.00
6211 FSE 12VDC ELEC STRIKE	630	878.00
6211 FSE DS (MORT/CYL) 630	630	1,110.00
6211 US32D 24VDC FS	630	925.00
6211 US32D 24VDC FSE	630	878.00
6211AL US32D 24VDC FSE	630	913.00
6211WF US32D 24VDC FSE	630	888.00
6212 US32D 24VDC FSE	630	1,039.00
6223 FSE 24VDC ELEC STRIKE	630	979.00
5100 3FP 689 24VDC	689	295.00
6300 US32D 12/24VDC FSE	630	880.00
6400 US32D 12/24VDC FSE	630	620.00

Von Duprin Exit Devices

98 Series

- 3' Devices are priced complete with standard trim and strike(s).
- 4' add \$21 list.

		US26D	US26	US15	643E	315
<b>EXIT HARDWARE</b>						
98EO	Rim Device	\$1,638.00	\$1,944.00	\$1,944.00	\$1,944.00	\$2,394.00
9827EO	Surface Vertical Rod Device	2,385.00	2,751.00	2,751.00	2,751.00	3,138.00
9849EO	Concealed Vertical Cable Device	2,492.00	2,783.00	2,783.00	2,783.00	3,236.00
<b>FIRE EXIT HARDWARE</b>						
98EO-F	Rim Device	\$1,874.00	\$2,180.00	\$2,180.00	\$2,180.00	\$2,630.00
9827EO-F	Surface Vertical Rod Device	2,733.00	3,099.00	3,099.00	3,099.00	3,486.00
9849EO-F	Concealed Vertical Cable Device	2,738.00	3,029.00	3,029.00	3,029.00	3,482.00

Von Duprin 35A Series

- 3' Devices are priced complete with standard trim and strike(s).
- 4' add \$21 list.

		US26D	US26	US15	643E	315
<b>EXIT HARDWARE</b>						
35A-EO	Rim Device	\$2,017.00	\$2,112.00	\$2,112.00	\$2,112.00	\$2,526.00
3549A-EO	Concealed Vertical Cable Device	2,867.00	2,971.00	2,971.00	2,971.00	3,490.00
<b>FIRE EXIT HARDWARE</b>						
35A-EO-F	Rim Device	\$2,047.00	\$2,142.00	\$2,142.00	\$2,142.00	\$2,556.00
3549A-EO-F	Concealed Vertical Cable Device	2,988.00	3,092.00	3,092.00	3,092.00	3,611.00

Concealed Vertical Cable (CVC) Reference:  
Nominal Door Opening Height

72"-82"	6' - 6'10"
* >82"-96"	* >6'10" - 8'
>96" -110"	>8' - 9'2"
>110" -120"	>9'2"-10'

\* Default Door Opening Height. Specify height if other than default.

**Device Options****Dogging Option**

Prefix		List Add
LD	Less Dogging	N/C

**Weep Holes**

Suffix		List Add
WH	Drainage (Weep) Holes in Mechanism Case	\$106.00
	3' device will have 5 holes - 6" spacing, 4' device will have 7 holes - 6" spacing	

**Switches**

Prefix		List Add
RX	Request to Exit - available on all 35A and 98 Series Devices	\$293.00

**Electric Latch Retraction**

Prefix		List Add
QEL	Quiet Electric Latch Retraction - available on all 35A and 98 Series Devices	\$1,008.00

**Electric Unlocking**

		List Add
E996	Electric Unlocking of outside E996 Trim - for 98 devices	\$734.00
	Available with L or LBE functions only. Specify handing.	
	Specify FAIL SECURE (FSE) or FAIL SAFE (FS).	

**Motorized Electric Unlocking**

		List Add
M996	Motorized Electronic Unlocking for outside M996 Trim - for 98 devices	\$734.00
	Available with L or LBE functions only. Specify Handing.	
	Ships FAIL SAFE (FS), but can be field converted to FAIL SECURE (FSE) with dip switch.	

**Allegion Connect**

Suffix		List Add
CON	Cross-category solution using common interconnect components for electrified options. Available with RX switches, QEL, and E996.	N/C

**NOTE:** For wire harness options refer to Power Supply and Electronic Component Section.

### Device Accessories

#### Dummy Touch Bars

- 3' Devices are priced complete with sex bolts.
- 4' add \$21 list.

Model No.	Description	US26D	US26	US15	643E	315
350	35A/98 series device dummy touch bar	\$936.00	\$936.00	\$936.00	\$936.00	\$1,678.00

#### 98 Series Trim

Specify device type when ordering (example: 996L-R)

Model No.	Description	Device Type	US26D	US26	US15	643E	SPLBLK
110MD-NL	Night Latch Cyl. Assy, MD Dr	-	\$155.00	\$155.00	\$155.00	\$155.00	\$155.00
996L	Lever	R&V	682.00	772.00	772.00	772.00	707.00
996L-BE	Lever, Blank Escutcheon	R&V	682.00	772.00	772.00	772.00	707.00
996L-NL	Lever, Night Latch	R&V	543.00	633.00	633.00	633.00	568.00

#### Lever Designs

Model No.	Description
Standard	06 Lever Design - furnished standard.
	Optional Lever Designs - Latitude (LAT),17, 07
Handing	Field reversible and furnished RHR if not specified

#### 35A Series Trim

Model No.	Description	US26D	US26	US15	643E	315
388 (NL-OP)	Night Latch Cylinder Trim	\$357.00	\$357.00	\$357.00	\$357.00	-

#### Power Transfer

Model No.	Description	SP28
EPT10	Ten 24 guage wires	\$590.00
EPT10 CON	Ten 24 guage wires with connectors	603.00

**24-R Device Series**

3' Devices are priced with standard trim and strikes, 4' add \$21 list.  
Cylinders are not included in the price.

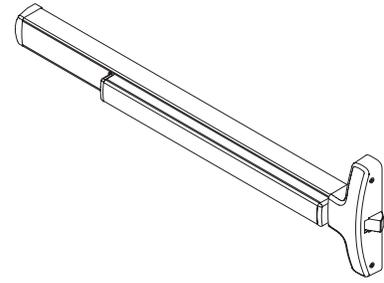

**EXIT HARDWARE**

**Rim Devices**

(Includes 299 Strike)

	Trim/Control	US19* US26D	US26	643E* US15*
* 24-R-EO		1598	1659	1805
* 24-R-NL-OP (Supplied as NL less trim)		1598	1659	1805
<b>Delta Trim (handed and field reversible)</b>				
24-R-DT	717DT	1898	1959	2105
24-R-DT	718DT	1920	1981	2127
* 24-R-NL	718NL*	1898	1959	2105
* 24-R-C	718C*	1828	1889	2035
<b>Knob Control (handed and field reversible)</b>				
24-R-K	711K	1956	2017	2163
24-R-K-BE	711K-BE	1956	2017	2163
24-R-K-NL	711K-NL	1956	2017	2163
<b>Dane Lever Control (handed and field reversible)</b>				
* 24-R-L	712L*	2038	2099	2245
* 24-R-L-BE	712L-BE*	2038	2099	2245
* 24-R-L-NL	712L-NL*	2038	2099	2245
* 24-R-L-DT	712L-DT*	2038	2099	2245

\* These devices and 712L, 712L-BE, 712L-NL, 712L-DT, 718C, 718NL trims are available in 643E, US15 and US19 finishes.

24 Series ordered in 313AN will be supplied with trims in SP313.

Handing: Trims are furnished RHR when handing is not specified.

24 Rim, comes with dead latching as a standard effective April 3, 2017.

**Sex Bolts:**

Optional Sex Bolts are recommended for center case mounting when device is used with hollow core wood, composite or light gauge hollow metal doors. See chart below for quantities and list prices.

Application	Sex Bolt 325 (Optional)	Sex Bolt 425 (Optional)	List Add
Hollow core wood, composite or light gauge hollow metal doors - EO (exit only device)	2	4	96.00
Hollow core wood, composite or light gauge hollow metal doors - Device with Trim	Not Required	4	64.00

**F-24-R Device Series**

**3' Devices are priced with standard trim and strikes, 4' add \$21 list.**

**Cylinders are not included in the price.**

**EXIT HARDWARE**

**Rim Devices**

(Includes 299F Strike)

	<b>Trim/Control</b>	<b>US19* US26D</b>	<b>US26</b>	<b>643E* US15*</b>
* F-24-R-EO		1834	1895	2041
* F-24-R-NL-OP (Supplied as NL less trim)		1834	1895	2041
<b>Delta Trim (handed and field reversible)</b>				
F-24-R-DT	717DT	2134	2195	2341
F-24-R-DT	718DT	2156	2217	2363
* F-24-R-NL	718NL*	2134	2195	2341
* F-24-R-C	718C*	2064	2125	2271
<b>Knob Control (handed and field reversible)</b>				
F-24-R-K	711K	2192	2253	2399
F-24-R-K-BE	711K-BE	2192	2253	2399
F-24-R-K-NL	711K-NL	2192	2253	2399
<b>Dane Lever Control (handed and field reversible)</b>				
* F-24-R-L	712L*	2274	2335	2481
* F-24-R-L-BE	712L-BE*	2274	2335	2481
* F-24-R-L-NL	712L-NL*	2274	2335	2481
* F-24-R-L-DT	712L-DT*	2274	2335	2481

\* These devices and 712L, 712L-BE, 712L-NL, 712L-DT, 718C, 718NL trims are available in 643E, US15 and US19 finishes.

24 Series ordered in 313AN will be supplied with trims in SP313.

**Handing:** Trims are furnished RHR when handing is not specified.

**Sex Bolts:**

Sex Bolts are supplied for center case mounting when device is used with wood, composite or non-reinforced hollow metal doors.

<b>Application</b>	<b>Sex Bolt 325 (Optional)</b>	<b>Sex Bolt 425 (Optional)</b>
Wood, composite or non-reinforced hollow metal doors - <b>EO (exit only device)</b>	2	4
Wood, composite or non-reinforced hollow metal doors - <b>Device with Trim</b>	Not Required	4

**24-V Device Series****3' Devices are priced with standard trim and strikes, 4' add \$21, 2' add \$130 list.****Cylinders are not included in the price.****EXIT HARDWARE****Surface Vertical Rod Devices**

(Includes 3788 and 2130 Strikes)

	Trim/Control	US19* US26D	US26	643E* US15*
* 24-V-EO		2097	2177	2348
* 24-V-NL-OP (Supplied as NL less trim)		2097	2177	2348
<b>Delta Trim (handed and field reversible)</b>				
24-V-DT	717DT	2397	2477	2648
24-V-DT	718DT	2419	2499	2670
* 24-V-NL	718NL*	2397	2477	2648
* 24-V-C	718C*	2327	2407	2578
<b>Knob Control (handed and field reversible)</b>				
24-V-K	711K	2455	2535	2706
24-V-K-BE	711K-BE	2455	2535	2706
24-V-K-NL	711K-NL	2455	2535	2706
<b>Dane Lever Control (handed and field reversible)</b>				
* 24-V-L	712L*	2537	2617	2788
* 24-V-L-BE	712L-BE*	2537	2617	2788
* 24-V-L-NL	712L-NL*	2537	2617	2788
* 24-V-L-DT	712L-DT*	2537	2617	2788

\* These devices and 712L, 712L-BE, 712L-NL, 712L-DT, 718C, 718NL trims are available in 643E, US15 and US19 finishes.

**Handing:** 24-V devices and noted Trims are handed and field reversible. The Device and Trims are furnished RHR when handing is not specified.**Extension Rods:** For door heights over 7'0" up to 8'0", 12" extension rods are furnished at no additional charge at the time of device order. For door heights over 8'0" up to 10'0" extension rods are furnished at prices shown in parts section with the device at the time of order.

MUST specify door height on order line.

**Sex Bolts:**

Optional Sex Bolts are recommended for center case and latch mounting when device is used with hollow core wood, composite or light gauge hollow metal doors. See chart below for quantities and list prices.

Application	Latches Sex Bolt 2729 (Optional)	Device Sex Bolt 425 (Optional)	Device Sex Bolt 325 (Optional)	List Add
Hollow core wood, composite or light gauge hollow metal doors - <b>EO (exit only device)</b>	6	2	2	\$142.00
Hollow core wood, composite or light gauge hollow metal doors - <b>Device with Trim</b>	6	2	Not Required	110.00
Hollow core wood, composite or light gauge hollow metal doors - <b>EO (exit only device) LBR</b>	3	2	2	103.00
Hollow core wood, composite or light gauge hollow metal doors - <b>Device with Trim LBR</b>	3	2	Not Required	71.00

**F-24-V Device Series**

**3' Devices are priced with standard trim and strikes, 4' add \$21, 2' add \$130 list.**  
**Cylinders are not included in the price.**

**FIRE EXIT HARDWARE**  
**Surface Vertical Rod Devices**  
 (Includes 3788 and 2130 Strikes)

Trim/Control		US19*	US26D	US26	643E* US15*
* F-24-V-EO		2316		2396	2567
* F-24-V-NL-OP (Supplied as NL less trim)		2316		2396	2567
<b>Delta Trim (handed and field reversible)</b>					
F-24-V-DT	717DT	2616		2696	2867
F-24-V-DT	718DT	2638		2718	2889
* F-24-V-NL	718NL*	2616		2696	2867
* F-24-V-C	718C*	2546		2626	2797
<b>Knob Control (handed and field reversible)</b>					
F-24-V-K	711K	2674		2754	2925
F-24-V-K-BE	711K-BE	2674		2754	2925
F-24-V-K-NL	711K-NL	2674		2754	2925
<b>Dane Lever Control (handed and field reversible)</b>					
* F-24-V-L	712L*	2756		2836	3007
* F-24-V-L-BE	712L-BE*	2756		2836	3007
* F-24-V-L-NL	712L-NL*	2756		2836	3007
* F-24-V-L-DT	712L-DT*	2756		2836	3007

\* These devices and 712L, 712L-BE, 712L-NL, 712L-DT, 718C, 718NL trims are available in 643E, US15 and US19 finishes.  
**Extension Rods:** For door heights over 7'0" up to 8'0", 12" extension rods are furnished at no additional charge at the time of device order.  
 For door heights over 8'0" up to 10'0" extension rods are furnished at prices shown in parts section with the device at the time of order.  
 MUST specify door height on order line.

**Sex Bolts:**

One 4122 Sex Bolt is supplied standard no charge for hinge side mounting. Sex Bolts are supplied for center case and latch mounting when device is used with wood, composite or non-reinforced hollow metal doors.

Application	Latches Sex Bolt 2729 (Supplied)	Device Sex Bolt 425 (Supplied)	Device Sex Bolt 325 (Supplied)
Wood, composite or non-reinforced hollow metal doors - <b>EO (exit only device)</b>	6	2	2
Wood, composite or non-reinforced hollow metal doors - <b>Device with Trim</b>	6	2	Not Required
Wood, composite or non-reinforced hollow metal doors - <b>EO (exit only device) LBR</b>	3	2	2
Wood, composite or non-reinforced hollow metal doors - <b>Device with Trim LBR</b>	3	2	Not Required

## 24 Device Options

### Cylinder Dogging

Not for use with Fire Exit Hardware

Prefix		List Add
CD	Cylinder Dogging available on all 24 series Panic Devices.	73
LD	Less Dogging available on all 24 series Panic Devices.	N/C

### Less Bottom Rod

Suffix		List Add
LBR	Less Bottom Rod available with UL Fire Label at no additional charge on F-24-V and F-24-C devices. Fire rated LBR devices must be ordered in pairs of Vertical Rod Devices. <b>For Fire Rated Devices specify one device LBR and second device LBR-AFL.</b> Second device provided with a Fire Pin.	N/C

### Electric Latch Retraction

Prefix		List Add
EL	<b>Electric Latch Retraction</b> - Available on all 24 series Panic and Fire Devices. Electrical Latch cannot be used in combination with CD, EA or KOR options.	846
MEL	<b>Motorized Electric Latch Retraction</b> - Available on all 24 series Panic and Fire Devices. Motorized Electric Latch Retraction cannot be used in combination with AX, HD, CD, EA, or KOR options.	777

**REFERENCE NOTE:**

PS914 is required for EL operation. See Power Supply section for more detail.

### Device Monitoring

Prefix		List Add
RX	<b>Touch Bar Request to Exit Switch</b> available on all 24 series devices. RX device monitoring switch can be used in combination with a DM or LM switch (except for 24-R panic and fire).	234
KOR	<b>Key Override</b> - Override device monitoring on a door by use of a keyed cylinder. KOR must be used in combination with a device monitoring switch.	66

### Exit Alarm

Prefix		List Add
EA	<b>Exit Alarm</b> available on 24-R and 24-V Panic and Fire Devices. Price includes switch - "RX" is standard, "LM" is optional at no charge. To order "Less Switch", <b>Deduct \$234 list.</b>	582

### Allegion Connect

Suffix		List Add
CON	Cross-category solution using common interconnect components for electrified options. Available with EL, MEL, EA, RX, EL-RX, MEL-RX options.	N/C

**NOTE:** For wire harness options refer to Power Supply and Electronic Component Section.

**24 Series Trim**  
Cylinders are not included in price unless noted.

**Athena Trim**

Model No.	Device Type	Description	US15	US26 US26D
715DT	R, V	Dummy Trim	265	265

**Control Trim**

Model No.	Device Type	Description	US15	US26 US26D
711K	R, V	Knob, Key Locks or Unlocks	358	358
711K	C	Knob, Key Locks or Unlocks	358	358
711K-BE	R, V	Knob, Blank Escutcheon	358	358
711K-BE	C	Knob, Blank Escutcheon	358	358
711K-NL	R, V	Knob, Night Latch	358	358
711K-NL	C	Knob, Night Latch	358	358

711 series trim are handed and field reversible. Trims are furnished RHR when handing is not specified.

**Delta Controls**

Model No.	Device Type	Description	US15	US26 US26D
717DT	R, V	Dummy Trim	300	300
717DT	C	Dummy Trim	300	300

717 series trim are handed and field reversible. Trims are furnished RHR when handing is not specified.

**Delta Controls**

Model No.	Device Type	Description	US15	643E* US19*, US26 US26D
718DT	C	Dummy Trim	322	322
718NL*	R, V	Night Latch	300	300
718NL*	C	Night Latch	300	300
718C*	R, V	Night Latch Less Pull	230	230
718C*	C	Night Latch Less Pull	230	230

**\* Available in 643E and US19.**

718 series trim are handed and field reversible. Trims are furnished RHR when handing is not specified.

**Control Lever Trims**

Model No.	Device Type	Description	US15	643E* US19*, US26 US26D
712L*	R, V	Dane Lever, Key Locks or Unlocks	440	440
712L*	C	Dane Lever, Key Locks or Unlocks	440	440
712L-BE*	R, V	Dane Lever, Blank Escutcheon	440	440
712L-BE*	C	Dane Lever, Blank Escutcheon	440	440
712L-NL*	R, V	Dane Lever, Night Latch	440	440
712L-NL*	C	Dane Lever, Night Latch	440	440
712L-DT*	R, V	Dane Lever, Dummy Trim	440	440
712L-DT*	C	Dane Lever, Dummy Trim	440	440

**\* Available in 643E and US19.**

712 series trim are handed and field reversible. Trims are furnished RHR when handing is not specified.

The Dane Lever is furnished standard. Optional lever designs Suro, Quantum and Avalon are available at no additional charge.

24 Series ordered in US32D will be supplied with trims in US15.

**25 Device Series**

**3' Devices are priced with standard trim and strike, 4' add \$21 list.**  
Cylinders are not included in the price.

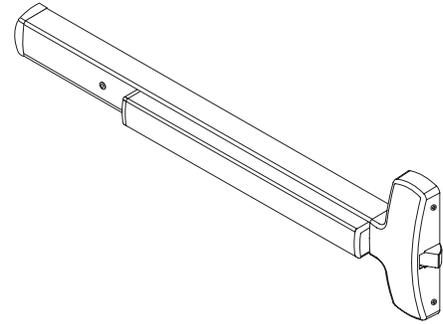
**EXIT HARDWARE****Rim Devices**

(Price includes 299 Strike)

	Trim/Control	US19* US26D	US26	643E* US15*
* 25-R-EO		1240	1290	1451
* 25-R-NL-OP (Supplied as NL less trim)		1240	1290	1451
<b>Lever - Dane (handed and field reversible)</b>				
* 25-R-L	510L*	1687	1746	1907
* 25-R-L-BE	510L-BE*	1687	1746	1907
* 25-R-L-NL	510L-NL*	1598	1708	1869
* 25-R-L-DT	510L-DT*	1598	1708	1869
<b>VR Lever (handed and field reversible)</b>				
* 25-R-L	511L*	1751	1810	1971
<b>Thumbpiece (non-handed)</b>				
25-R-TP	512TP	1614	1729	1890
25-R-TP-BE	512TP-BE	1614	1729	1890
* 25-R-NL	512-NL*	1540	1644	1805
<b>Knob (non-handed)</b>				
25-R-K	513K	1575	1683	1844
25-R-K-BE	513K-BE	1575	1683	1844
25-R-K-NL	513K-NL	1575	1683	1844
25-R-K-DT	513K-DT	1575	1683	1844
<b>DT Pull (717 handed and field reversible, 512 non-handed)</b>				
25-R-DT	717DT	1540	1590	1751
25-R-DT	512DT	1473	1644	1805

\* These devices and 510L, 510L-BE, 510L-NL, 510L-DT, 511L, 512NL trims are available in 643E, US15, and US19 finishes.

**Handing:** 25-R Device is non-handed. Trims are furnished RHR when handing is not specified.

**Sex Bolts:**

Optional Sex Bolts are recommended for center case mounting when device is used with hollow core wood, composite or light gauge hollow metal doors. See chart below for quantities and list prices.

Application	Sex Bolt 425 (Optional)	List Add
Hollow core wood, composite, or light gauge hollow metal doors - <b>EO (exit only device)</b>	8	\$128.00
Hollow core wood, composite, or light gauge hollow metal doors - <b>Device x Trim</b>	4	64.00

**Device Series F-25-R**

**3' Devices are priced with standard trim and strike, 4' add \$21 list.  
Cylinders are not included in the price.**

**FIRE EXIT HARDWARE**

**Rim Devices**

(Price includes 299F Strike)

	Trim/Control	US19* US26D	US26	643E* US15*
* F-25-R-EO		1477	1527	1688
* F-25-R-NL-OP (Supplied as NL less trim)		1477	1527	1688
<b>Lever - Dane (handed and field reversible)</b>				
* F-25-R-L	510L*	1924	1983	2144
* F-25-R-L-BE	510L-BE*	1924	1983	2144
* F-25-R-L-NL	510L-NL*	1835	1945	2106
* F-25-R-L-DT	510L-DT*	1835	1945	2106
<b>VR Lever (handed and field reversible)</b>				
* F-25-R-L	511L*	1988	2047	2208
<b>Thumbpiece (non-handed)</b>				
F-25-R-TP	512TP	1851	1966	2127
F-25-R-TP-BE	512TP-BE	1851	1966	2127
* F-25-R-NL	512-NL*	1777	1881	2042
<b>Knob (non-handed)</b>				
F-25-R-K	513K	1812	1920	2081
F-25-R-K-BE	513K-BE	1812	1920	2081
F-25-R-K-NL	513K-NL	1812	1920	2081
F-25-R-K-DT	513K-DT	1812	1920	2081
<b>DT Pull (717 handed and field reversible, 512 non-handed)</b>				
F-25-R-DT	717DT	1777	1827	1988
F-25-R-DT	512DT	1710	1881	2042

\* These devices and 510L, 510L-BE, 510L-NL, 510L-DT, 511L, 512NL trims are available in 643E, US15, and US19 finishes.  
Handing: F-25-R Device is non-handed. Trims are furnished RHR when handing is not specified.

**Sex Bolts:**

Sex Bolts are supplied for center case mounting when device is used with wood, composite or non-reinforced hollow metal doors. See chart below for quantities.

Application	Sex Bolt 425 (Supplied)
Wood, composite or non-reinforced hollow metal doors - <b>EO (exit only device)</b>	8
Wood, composite or non-reinforced hollow metal doors - <b>Device x Trim</b>	4

**25-V Device Series**

**3' Devices are priced with standard trim and strikes, 4' add \$21 list and 2' add \$130 list. Cylinders are not included in the price.**

**EXIT HARDWARE****Surface Vertical Rod Devices**

(Includes 3788 &amp; 2130 Strikes )

	Trim/Control	US19* US26D	US26	643E* US15*
* 25-V-EO		1803	1879	2024
* 25-V-NL-OP (Supplied as NL less trim)		1803	1879	2024
<b>Lever - Dane (handed and field reversible)</b>				
* 25-V-L	510L*	2250	2335	2480
* 25-V-L-BE	510L-BE*	2250	2335	2480
* 25-V-L-NL	510L-NL*	2161	2297	2442
* 25-V-L-DT	510L-DT*	2161	2297	2442
<b>VR Lever (handed and field reversible)</b>				
* 25-V-L	511L*	2314	2399	2544
<b>Thumbpiece (non-handed)</b>				
25-V-TP	512TP	2177	2318	2463
25-V-TP-BE	512TP-BE	2177	2318	2463
* 25-V-NL	512-NL*	2103	2233	2378
<b>Knob (non-handed)</b>				
25-V-K	513K	2138	2272	2417
25-V-K-BE	513K-BE	2138	2272	2417
25-V-K-NL	513K-NL	2138	2272	2417
25-V-K-DT	513K-DT	2138	2272	2417
<b>DT Pull (717 handed and field reversible, 512 non-handed)</b>				
25-V-DT	717DT	2103	2179	2324
25-V-DT	512DT	2036	2233	2378

\* These devices and 510L, 510L-BE, 510L-NL, 510L-DT, 511L, 512NL trims are available in 643E, US15, and US19 finishes.

**Handing:** The 25-V Device is handed and field reversible. Trims are furnished RHR when handing is not specified.

**Extension Rods:** For door heights over 7'0" up to 8'0", 12" extension rods are furnished at no additional charge at the time of device order.

For door heights over 8'0" up to 10'0" extension rods are furnished at prices shown in parts section with the device at the time of order.

MUST specify door height on order line.

**Sex Bolts:**

Optional Sex Bolts are recommended for center case and latch mounting when device is used with hollow core wood, composite or light gauge hollow metal doors. See chart below for quantities and list prices.

Application	Latches Sex Bolt 2729 (Optional)	Device Sex Bolt 425 (Optional)	List Add
Hollow core wood, composite or light gauge hollow metal doors - <b>EO (exit only device)</b>	6	6	\$174.00
Hollow core wood, composite or light gauge hollow metal doors - <b>Device x Trim</b>	6	2	110.00
Hollow core wood, composite or light gauge hollow metal doors - <b>EO (exit only device) LBR</b>	3	6	135.00
Hollow core wood, composite or light gauge hollow metal doors - <b>Device x Trim LBR</b>	3	2	71.00

**F-25-V Device Series**

**3' Devices are priced with standard trim and strikes, 4' add \$21 list and 2' add \$130 list. Cylinders are not included in the price.**

**FIRE EXIT HARDWARE**  
**Surface Vertical Rod Devices**  
 (Includes 3788 & 2130 Strikes )

	Trim/Control	US19* US26D	US26	643E* US15*
* F-25-V-EO		2023	2099	2244
* F-25-V-NL-OP (Supplied as NL less trim)		2023	2099	2244
<b>Lever - Dane (handed and field reversible)</b>				
* F-25-V-L	510L*	2470	2555	2700
* F-25-V-L-BE	510L-BE*	2470	2555	2700
* F-25-V-L-NL	510L-NL*	2381	2517	2662
* F-25-V-L-DT	510L-DT*	2381	2517	2662
<b>VR Lever (handed and field reversible)</b>				
* F-25-V-L	511L*	2534	2619	2764
<b>Thumbpiece (non-handed)</b>				
F-25-V-TP	512TP	2397	2538	2683
F-25-V-TP-BE	512TP-BE	2397	2538	2683
* F-25-V-NL	512-NL*	2323	2453	2598
<b>Knob (non-handed)</b>				
F-25-V-K	513K	2358	2492	2637
F-25-V-K-BE	513K-BE	2358	2492	2637
F-25-V-K-NL	513K-NL	2358	2492	2637
F-25-V-K-DT	513K-DT	2358	2492	2637
<b>DT Pull (717 handed and field reversible, 512 non-handed)</b>				
F-25-V-DT	717DT	2323	2399	2544
F-25-V-DT	512DT	2256	2453	2598

\* These devices and 510L, 510L-BE, 510L-NL, 510L-DT, 511L, 512NL trims are available in 643E, US15, and US19 finishes.  
**Handing:** The F-25-V Device is handed and field reversible. Trims are furnished RHR when handing is not specified.  
**Extension Rods:** For door heights over 7'0" up to 8'0", 12" extension rods are furnished at no additional charge at the time of device order. For door heights over 8'0" up to 10'0" extension rods are furnished at prices shown in parts section with the device at the time of order. MUST specify door height on order line.

**Sex Bolts:**

Sex Bolts are supplied for center case mounting and latch mounting when device is used with wood, composite or non-reinforced hollow metal doors. See chart below for quantities.

Application	Latches Sex Bolt 2729 (Supplied)	Device Sex Bolt 425 (Supplied)
Wood, composite or non-reinforced hollow metal doors - <b>EO (exit only device)</b>	6	6
Wood, composite or non-reinforced hollow metal doors - <b>Device x Trim</b>	6	2
Wood, composite or non-reinforced hollow metal doors - <b>EO (exit only device) LBR</b>	3	6
Wood, composite or non-reinforced hollow metal doors - <b>Device x Trim LBR</b>	3	2

## 25 Device Options

**Cylinder Dogging Not for use with Fire Exit Hardware**

Prefix		List Add
CD	Cylinder Dogging available on all 25 series Panic Devices.	73
LD	Less Dogging available on all 25 series Panic Devices.	N/C

**Less Bottom Rod**

Suffix		List Add
LBR	Less Bottom Rod available with UL Fire Label at no additional charge on F-25-V and F-25-C devices. <b>Fire rated LBR devices must be ordered in pairs of Vertical Rod Devices.</b> For Fire Rated Devices specify one device LBR and second device LBR-AFL. Second device provided with a Fire Pin.	N/C

**Accessible Device**

Suffix		List Add
AX	Accessible device compliant with the California Building Code (Section 11B-309.4) requirement for 5 lb. maximum operational force. Available on 3' and 4' AX-25-R, AX-F-25-R, AX-25-V, AX-F-25-V, AX-25-V-LBR, AX-F-25-V-LBR/LBR-AFL, AX-25-C, AX-F-25-C, AX-25-C-LBR, AX-F-25-C-LBR/LBR-AFL. Trim functions available EO, DT, NL, L, L-BE, L-NL, L-DT, NL-OP, and C. Other device and trim options compatible with AX25 devices: EL, RX, DM, LM, CON, EA, FSA/FSE, CD, LD.	29

**Hurricane Device Meets all FBC Hurricane Listings. Consult factory for specific Applications.**

Prefix		List Add
HH	<b>Hurricane option</b> available on 25-R*, F-25-R, 25-V, F-25-V. Prefix device "HH". <b>Note:</b> HH25-V-EO and HH-F-25-V-EO, will be supplied with twelve sexbolts. Add \$174.00 LIST Other device functions will be supplied with eight sexbolts. Add \$110.00 LIST. *HH-25-R requires 299F strike; Strike 299F will be provided/charged in place of 299 Strike.	33
	<b>Standard Devices 25-C, F-25-C, 25-M, F-25-M</b> meet all FBC Hurricane listing requirements. Consult factory for specific applications. Prefix "HH" is not required on these devices.	N/C

**Electric Latch Retraction**

Prefix		List Add
EL	<b>Electric Latch Retraction</b> - Available on all 25 series Panic and Fire Devices. Electric Latch cannot be used in combination with CD, EA or KOR options.	846
MEL	<b>Motorized Electric Latch Retraction</b> - Available on all 25 series Panic and Fire Devices except for 25-M and F-25-M. Motorized Electric Latch Retraction cannot be used in combination with AX, HD, CD, EA, or KOR options	777

**REFERENCE NOTE:** PS914 is required for EL operation. See Power Supply section for more detail.

**Device Monitoring**

Prefix		List Add
RX	<b>Touch Bar Request to Exit Switch</b> available on all 25 series devices. RX dogging monitoring switch can be used in combination with a DM or LM switch.	234
DM	<b>Latch Bolt Monitor Switch</b> (provide signal when latch bolt is fully extended) available on all 25 series devices. DM device monitoring switch can be used in combination with a RX switch, but is not available in combination with a LM switch.	246
LM	<b>Latch Bolt Monitoring Switch</b> (provide signal when latch bolt is fully retracted) available on all 25 series devices. LM device monitoring switch can be used in combination with a RX switch, but is not available in combination with a DM switch.	234
KOR	<b>Key Override</b> - Override device monitoring on a door by use of a keyed cylinder. KOR must be used in combination with a device monitoring switch.	66

**Allegion Connect**

Suffix		List Add
CON	Cross-category solution using common interconnect components for electrified options. Available with EL, MEL, EA, RX, EL-RX, MEL-RX options.	N/C

**NOTE:** For wire harness options refer to Power Supply and Electronic Component Section.

**Exit Alarm**

Prefix		List Add
EA	<b>Exit Alarm</b> available on 25-R and 25-V Panic and Fire Devices. Price includes switch - "RX" is standard, "LM" is optional at no charge. To order "Less Switch", <b>Deduct \$207 list.</b> For vertical rod tampering monitoring on Surface Vertical Devices, specify device with DM (Latch Bolt Monitor Switch). <b>Add \$216 list.</b> 9 volt battery included.	582

**Electric Lock or Unlock of Trims**

Prefix		List Add
FSA	<b>Electric Lock/Unlock Trim, Fail Safe</b> (unlocks when power is interrupted).	344
FSE	<b>Electric Lock/Unlock Trim, Fail Secure</b> (locks when power is interrupted).	344

**REFERENCE NOTES:**

FSA/FSE available on all 25 series devices. Available with TP, K, or L functions only. Can be used in combination with EL, EA, or any device monitoring switch. Power supply PS902 is the recommended power supply for use with FSA/FSE trim. If paired with an EL device, PS914 is required. See the power supply section for more information.

**25 Series Trims**  
Cylinders are not included in price.

**Lever Trim**

Model No.	Lever Style	Device Type	Description	US19* US26D	643E* US15* US26 US32
510L	Dane	R,V,M,C	Lever, Key Locks or Unlocks	447	456
510L-NL	Dane	R,V,M,C	Lever, Night Latch	358	418
510L-DT	Dane	R,V,M,C	Lever, Dummy Trim	358	418
510L-BE	Dane	R,V,M,C	Lever, Blank Escutcheon	447	456

**\* 643E, US15, US19 are available on the lever trim type listed above except Sutro.**  
510 series trim are handed and field reversible. Trims are furnished RHR when handing is not specified.  
The Dane Lever is furnished standard. Optional lever designs Broadway, Boardwalk, Danish, Latitude, Longitude, Sutro, Quantum and Avalon are available at no additional charge.  
**Electric Lock or Unlock** option is available on 510L function only.  
Suffix FSA for Fail Safe operation, or **FSE** for Fail Secure operation, **add \$343 List.**  
Knurling on Dane lever, **add \$74 List.** Contact factory for lead times.

**Vandal Resistant Trim**

Model No.	Lever Style	Device Type	Description	US32D US19* US26D	US3 643E* US15* US26 US32
511L*	Dane	R,V,M,C	Lever, Key Locks or Unlocks	511	520

**\* 643E, US15, US19 are available on the lever trim type listed above except Sutro.**  
511 series trim are handed and field reversible. Trims are furnished RHR when handing is not specified.  
The Dane Lever is furnished standard. Optional lever designs Broadway, Boardwalk, Danish, Latitude, Longitude, Sutro, Quantum and Avalon are available at no additional charge.  
**Electric Lock or Unlock** option is available on 511L.  
Suffix FSA for Fail Safe operation, or **FSE** for Fail Secure operation, **add \$343 List.**

**Night Latch and Thumbpiece Trim**

Model No.	Device Type	Description	US32D US19* US26D	US3 643E* US15* US26 US32
512NL*	R,V,M,C	Night Latch	300	354
512TP	R,V,M,C	Thumbpiece, Key Locks or Unlocks	374	439
512TP-BE	R,V,M,C	Thumbpiece, Blank Escutcheon	374	439

**\* Available in 643E, US15, US19 on all Falcon Exit levers except for Sutro.**  
**Electric Lock or Unlock** option is available on 512TP function only.  
Suffix FSA for Fail Safe operation, or **FSE** for Fail Secure operation, **add \$343 List.**

**Knob Trim**

Model No.	Device Type	Description	US32D US26D	US3 US26 US32
513K	R,V,M,C	Knob, Key Locks or Unlocks	335	393
513K-NL	R,V,M,C	Knob, Night Latch	335	393
513K-DT	R,V,M,C	Knob, Dummy Trim	335	393
513K-BE	R,V,M,C	Knob, Blank Escutcheon	335	393

**Electric Lock or Unlock** option is available on 513K function only.  
Suffix FSA for Fail Safe operation, or **FSE** for Fail Secure operation, **add \$343 List.**

**Pull Trim**

Model No.	Device Type	Description	US32D US26D	US3 US26 US32
512DT	R,V,M,C	Dummy Trim	233	354

**Delta Trim**

Model No.	Device Type	Description	SP313	US19* US15 US26D US3 643E* US26 US32
717DT	R,V,M,C	Dummy Trim	257	300
718C*	C	Night Latch Less Pull	209	230

**\* Available in 643E and US19.**  
717 and 718 series trim are handed and field reversible. Trims are furnished RHR when handing is not specified.

**19-R Device Series**

3' Devices are priced with standard trim and strikes, 4' add \$21 list.

Cylinders are not included in price unless noted.

**EXIT HARDWARE****Rim Devices** (Includes F570 Strike)

		SP28 SP313	US32D
<b>Trim/Control</b>			
19-R-EO		325	572
<b>Trident Trim (must specify handing)</b>			
19-R-DT	920DT	368	615
19-R-NL	920NL	401	648
<b>Centron Trim (non-handed)</b>			
19-R-EO	930EO	363	610
19-R-DT	930DT	368	615
19-R-NL	930NL	385	632
19-R-C	930C	378	625
19-R-DT	917DT	359	606
<b>Control Trim (non-handed)</b>			
19-R-DT	918DT	450	802
19-R-NL	918NL	450	802
<b>Knob Control (handed and field reversible)</b>			
19-R-K	911K	450	802
19-R-K-BE	911K-BE	450	802
19-R-K-NL	911K-NL	450	802
<b>Dane Lever Control (handed and field reversible)</b>			
19-R-L	912L	500	840
19-R-L-BE	912L-BE	500	840
19-R-L-NL	912L-NL	500	840
19-R-L-DT	912L-DT	500	840
<b>Key in Lever (handed and field reversible)</b>			
19-R-KIL	914-KIL-KD W/CYL	535	782
19-R-KIL-NL	914-KIL-NL-KD W/CYL	535	782
19-R-KIL-BE	914-KIL-BE	535	782
19-R-KIL-IC	914-KIL-IC W/CYL	584	831

**REFERENCE NOTE:**

930 series trim is available in SP313 and US32D finish only. 19 series devices order in SP28 paired with 930 trim are supplied with US32D finish trim.

**Sex Bolts:**

Three 4122 Sex Bolts are supplied standard no charge, one for hinge side mounting and two for center case mounting.

**F-19-R Device Series**  
**3' Devices are priced with standard trim and strike, 4' add \$21 list.**  
**Cylinders are not included in the price unless noted.**

**FIRE EXIT HARDWARE**  
**Rim Devices (Includes F570 Strike)**

		<b>SP28 SP313</b>	<b>US32D</b>
<b>Trim/Control</b>			
F-19-R-EO		407	667
<b>Trident Trim (must specify handing)</b>			
F-19-R-DT	920DT	450	710
F-19-R-NL	920NL	483	743
<b>Centron Trim (non-handed)</b>			
F-19-R-EO	930EO	445	705
F-19-R-DT	930DT	450	710
F-19-R-NL	930NL	467	727
F-19-R-C	930C	460	720
F-19-R-DT	917DT	441	701
<b>Control Trim (non-handed)</b>			
F-19-R-DT	918DT	532	897
F-19-R-NL	918NL	532	897
<b>Knob Control (handed and field reversible)</b>			
F-19-R-K	911K	532	897
F-19-R-K-BE	911K-BE	532	897
F-19-R-K-NL	911K-NL	532	897
<b>Dane Lever Control (handed and field reversible)</b>			
F-19-R-L	912L	582	935
F-19-R-L-BE	912L-BE	582	935
F-19-R-L-NL	912L-NL	582	935
F-19-R-L-DT	912L-DT	582	935
<b>Key in Lever (handed and field reversible)</b>			
F-19-R-KIL	914-KIL-KD W/CYL	617	877
F-19-R-KIL-NL	914-KIL-NL-KD W/CYL	617	877
F-19-R-KIL-BE	914-KIL-BE	617	877
F-19-R-KIL-IC	914-KIL-IC W/CYL	666	926

**REFERENCE NOTE:**  
**930 series trim** is available in SP313 and US32D finish only. 19 series devices order in SP28 paired with 930 trim are supplied with US32D finish trim.

**Sex Bolts:**  
 Three 4122 Sex Bolts are supplied standard, one for hinge side mounting and two for center case mounting.  
 Two 2729 Sex bolts are supplied for additional center case mounting when device is used with wood, composite or non-reinforced hollow metal doors.

<b>Application</b>	<b>Sex Bolt 2729 (Supplied)</b>
Wood, composite or non-reinforced hollow metal doors	2

**19-V Device Series****3' Devices are priced with standard trim and strikes, 4' add \$21 list.****Cylinders are not included in the price unless noted.****EXIT HARDWARE****Surface Vertical Rod Devices**

(Includes 3788 and 2130 Strikes)

		SP28 SP313	US32D
<b>Trim/Control</b>			
19-V-EO		509	958
<b>Trident Trim (must specify handing)</b>			
19-V-DT	920DT	552	1001
19-V-NL	920NL	585	1034
<b>Centron Trim (non-handed)</b>			
19-V-EO	930EO	547	996
19-V-DT	930DT	552	1001
19-V-NL	930NL	569	1018
19-V-C	930C	562	1011
19-V-DT	917DT	543	992
<b>Control Trim (non-handed)</b>			
19-V-DT	918DT	634	1188
19-V-NL	918NL	634	1188
<b>Knob Control (handed and field reversible)</b>			
19-V-K	911K	634	1188
19-V-K-BE	911K-BE	634	1188
19-V-K-NL	911K-NL	634	1188
<b>Dane Lever Control (handed and field reversible)</b>			
19-V-L	912L	684	1226
19-V-L-BE	912L-BE	684	1226
19-V-L-NL	912L-NL	684	1226
19-V-L-DT	912L-DT	684	1226
<b>Key in Lever (handed and field reversible)</b>			
19-V-KIL	914-KIL-KD W/CYL	719	1168
19-V-KIL-NL	914-KIL-NL-KD W/CYL	719	1168
19-V-KIL-BE	914-KIL-BE	719	1168
19-V-KIL-IC	914-KIL-IC W/CYL	768	1217

**REFERENCE NOTES:****Handing:** 19-V devices are handed and field reversible. Devices and Trims are furnished RHR when handing is not specified.**Extension Rods:** For door heights over 7'0" up to 8'0", 12" extension rods are furnished at no additional charge at the time of device order.

For door heights over 8'0" up to 10'0" extension rods are furnished at prices shown in parts section with the device at the time of order.

MUST specify door height on order line.

**930 series trim** is available in SP313 and US32D finish only. 19 series devices order in SP28 paired with 930 trim are supplied with US32D finish trim.**Sex Bolts:**

Three 4122 Sex Bolts are supplied standard no charge, one for hinge side mounting and two for center case mounting.

Six 2729 Sex Bolts are recommended for latch mounting when device is used with hollow core, composite or light gauge hollow metal doors. See chart below for quantities and list prices.

Application	Sex Bolt 2729 (Optional)	List Add
Hollow core, composite or light gauge hollow metal doors	6	78

**F-19-V Device Series**

**3' Devices are priced with standard trim and strikes, 4' add \$21 list.**  
**Cylinders are not included in the price unless noted.**

**FIRE EXIT HARDWARE**  
**Surface Vertical Rod Devices**  
 (Includes 3788 and 2130 Strikes)

	<b>Trim/Control</b>	<b>SP28 SP313</b>	<b>US32D</b>
F-19-V-EO		637	1078
<b>Trident Trim (must specify handing)</b>			
F-19-V-DT	920DT	680	1121
F-19-V-NL	920NL	713	1154
<b>Centron Trim (non-handed)</b>			
F-19-V-EO	930EO	675	1116
F-19-V-DT	930DT	680	1121
F-19-V-NL	930NL	697	1138
F-19-V-C	930C	690	1131
F-19-V-DT	917DT	671	1112
<b>Control Trim (non-handed)</b>			
F-19-V-DT	918DT	762	1308
F-19-V-NL	918NL	762	1308
<b>Knob Control (handed and field reversible)</b>			
F-19-V-K	911K	762	1308
F-19-V-K-BE	911K-BE	762	1308
F-19-V-K-NL	911K-NL	762	1308
<b>Dane Lever Control (handed and field reversible)</b>			
F-19-V-L	912L	812	1346
F-19-V-L-BE	912L-BE	812	1346
F-19-V-L-NL	912L-NL	812	1346
F-19-V-L-DT	912L-DT	812	1346
<b>Key in Lever (handed and field reversible)</b>			
F-19-V-KIL	914-KIL-KD W/CYL	847	1288
F-19-V-KIL-NL	914-KIL-NL-KD W/CYL	847	1288
F-19-V-KIL-BE	914-KIL-BE	847	1288
F-19-V-KIL-IC	914-KIL-IC W/CYL	896	1337

**REFERENCE NOTES:**

**Handing:** F-19-V devices are handed and field reversible. Devices and Trims are furnished RHR when handing is not specified.  
**Extension Rods:** For door heights over 7'0" up to 8'0", 12" extension rods are furnished at no additional charge at the time of device order.  
 For door heights over 8'0" up to 10'0" extension rods are furnished at prices shown in parts section with the device at the time of order.  
 MUST specify door height on order line.  
 930 series trim is available in SP313 and US32D finish only. 19 series devices order in SP28 paired with 930 trim are supplied with US32D finish trim.

**Sex Bolts:**

Three 4122 Sex Bolts are supplied standard no charge, one for hinge side mounting and two for center case mounting.  
 Six 2729 are supplied for additional latch case mounting when device is used with wood, composite or non-reinforced hollow metal doors.

<b>Application</b>	<b>Sex Bolt 2729 (Supplied)</b>
Wood, composite or non-reinforced hollow metal doors	6

## 19 Device Options

### Cylinder Dogging

Not for use with Fire Exit Hardware

Prefix		List Add
CD	Cylinder Dogging available on all 19 series Panic Devices.	73
LD	Less Dogging available on all 19 series Panic Devices	N/C

### Less Bottom Rod

Suffix		List Add
LBR	Less Bottom Rod available with UL Fire Label at no additional charge on F-19-V devices. <b>Fire rated LBR devices must be ordered in pairs of Vertical Rod Devices.</b> For Fire Rated Devices specify one device LBR and second device LBR-AFL. Second device provided with a Fire Pin.	N/C

\* The 19-Series Exit Alarm option has been eliminated. Consult Customer Care for availability and warranty claims.

### Accessible Device

Suffix		List Add
AX	Accessible device compliant with the California Building Code (Section 11B-309.4) requirement for 5 lb. maximum operational force. Available on 3' and 4' AX-19-R, AX-F-19-R, AX-19-V, AX-F-19-V, AX-19-V-LBR, AX-F-19-V-LBR/LBR-AFL. Trim functions available EO, DT, NL, L, L-BE, L-NL, L-DT, C, KIL, KIL-BE, KIL-NL, and KIL-IC.	29

**19 Series Trims**

Cylinders are not included in price unless noted.

**Trident Trim**

Model No.	Lever Style	Description	SP28, SP313	US32D
920DT	-	Dummy Trim	43	-
920NL	-	Night Latch	76	-

920 series trim are handed and not field reversible, specify RHR or LHR.

**Centron Trim**

Model No.	Lever Style	Description	SP28	US32D, SP313
917DT	-	Dummy Trim	34	34
930EO	-	Exit Only	-	38
930DT	-	Dummy Trim	-	43
930NL	-	Night Latch	-	60
930C	-	Night Latch Less Pull	-	53

930 series trim are available in SP313 and US32D finish only.

**Control Trim**

Model No.	Lever Style	Description	SP28, SP313	US15
918DT	-	Dummy Trim	125	230
918NL	-	Night Latch	125	230
911K	-	Knob, Key Locks or Unlocks	125	230
911K-BE	-	Knob, Blank Escutcheon	125	230
911K-NL	-	Knob, Night Latch	125	230

911 series trim are handed and field reversible. Trims are furnished RHR when handing is not specified.

**Lever Trim**

Model No.	Lever Style	Description	SP28, SP313	US15
912L	Dane	Lever, Key Locks or Unlocks	175	268
912L-BE	Dane	Lever, Blank Escutcheon	175	268
912L-NL	Dane	Lever, Night Latch	175	268
912L-DT	Dane	Lever, Dummy Trim	175	268

Optional lever designs Quantum and Sutro are available at no additional charge.

912 series trim are handed and field reversible. Trims are furnished RHR when handing is not specified.

**Key In Lever Trims**

Model No.	Lever Style	Description	US32D, SP313
914KIL-KD	Dane	Key in Lever, with Keyed Different Cylinder	210
914KIL-BE	Dane	Key in Lever, Blank Escutcheon	210
914KIL-NL-KD	Dane	Key in Lever, Night Latch with Cylinder	210
914KIL-IC	Dane	Key in Lever with IC Core Cylinder	259

914 series trim are handed and field reversible. Trims are furnished RHR when handing is not specified.

914 KIL-KD, KIL-NL-KD come standard with a C keyway and 914 KIL-IC come standard with a A keyway.

Consult factory if other keyways are desired to order separately.

**1690 Concealed Vertical Rod Pushpad Exit Devices**

Devices are priced for 30", 36" x 7',

Aluminum or Hollow Metal Doors.

Hex Bottom Latch furnished standard.

(Price includes PB48 Strike)

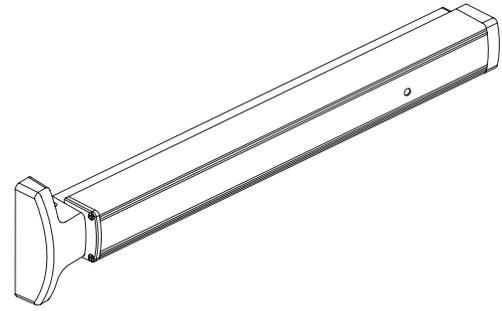

Model No.	US26	US26D	Standard Trim
1690EO	717	688	-
1691DT	1159	1130	9970 Pull
1692NL-OP/HB-OP	856	827	169CA w/Rim Cylinder
1694NL-P/HB-P	1192	1165	9970 Pull 169CA w/Rim Cylinder

**REFERENCE NOTES:**

Devices are supplied 36" x 7' standard, if not specified.

Rim cylinder supplied standard with NL and HB options is C keyway.

**Extra Length**

	List Add
42"	21.00
48"	30.00

**Optional Latches**

Suffix		List Add
RL	Rod Bottom Latch	33.00
PL	Pullman Bottom Latch	33.00
ES	Top Latch for use with Electric Strikes Device Furnished LBR (Less Bottom Rod and Less Strike) <b>deduct \$28 List</b>	37.00
Less Rods	For retrofit of 1990 crossbar device, <b>deduct \$53 List</b>	

**Door Heights over 7'**

	List Add
Up to 8'	75.00
Up to 9'	95.00
Up to 10'	110.00

**Device Options**

		List Add
RX Switch	Base Exit Device unit modified Request to Exit Switch monitoring pushpad. <b>Prefix device "RX".</b>	245.00
Electric Latch Retraction	Base Exit Device unit modified with Electric Latch Retraction. <b>Prefix device "EL".</b> The EL option is not field replaceable on this model.	620.00

**(One PS914 x 900-2RS is the minimum requirement to power one or two EL devices. See Power Supply Section for requirements and options.)**

Electric Dogging	Base Exit Device unit modified with Electric Dogging <b>Prefix device "ED".</b>	657.00
HH	Hurricane device. Available up to 8' device only. <b>Prefix device "HH".</b> HH is for a Hurricane device for all door manufactures other than YKK.	131.00
HHYKK	Hurricane device. Available up to 8' device only. <b>Prefix device "HHYKK".</b> HHYKK is for a Hurricane device for door manufacture YKK.	131.00

**REFERENCE NOTES:**

For EL1690 Door widths other than the standard size (30", 36", 42" or 48"), please specify exact door width. For non-standard widths, the price of the next widest standard size will apply. HH (Hurricane) 1690 devices are hurricane rated by specific door manufacturers. Consult your device manufacturer to assure the HH1690 is hurricane rated with their door solution.

**1790 Series Rim Type Pushpad Exit Devices**  
**Devices are priced for 30" and 36",**  
**Aluminum or Hollow Metal Doors.**  
 (Price includes TD35 Strike)

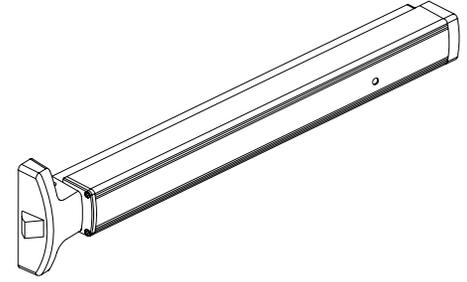

Model No.	US26	US26D	Standard Trim
1790EO	666	642	-
1791DT	1108	1084	9970 Pull
1792NL-OP/HB-OP	772	748	179CA w/Rim Cylinder
1794NL-P/HB-P	1214	1190	9970 Pull 179CA w/Rim Cylinder

**REFERENCE NOTES:**  
 Devices are supplied 36" x 7" standard, if not specified.  
 Rim cylinder supplied standard with NL and HB options is C keyway.

Extra Length	List Add
42"	21.00
48"	30.00

Device Options	List Add
RX Switch Base Exit Device unit modified Request to Exit Switch monitoring pushpad. <b>Prefix device "RX".</b>	245.00
Electric Latch Retraction Base Exit Device unit modified with Electric Latch Retraction. <b>Prefix device "EL".</b> The EL option is not field replaceable on this model.	620.00

**(One PS914 x 900-2RS is the minimum requirement to power one or two EL devices. See Power Supply Section for requirements and options.)**

Electric Dogging Base Exit Device unit modified with Electric Dogging <b>Prefix device "ED".</b>	657.00
--	--------

**REFERENCE NOTES:**  
 For EL1790 Door widths other than the standard size (30", 36", 42" or 48"), please specify exact door width.  
 For non-standard widths, the price of the next widest standard size will apply.

**Lever Control**

		P28 P13 P35	US15
179L	Lever Control	383	427
179L-BE	Lever Control, Blank Escutcheon	383	427
179L-NL	Lever Control, Night Latch	383	427

**REFERENCE NOTES:**  
 Lever Controls are Handed. Specify handing RHR or LHR.  
 179L Trims are field retrofittable with all 1790 Series Devices.  
 For initial installation requiring lever trim, the 1790EO is the suggested device to order with the 179L trims.  
 179L and L-NL require a 1 1/8" mortise cylinder with straight cam, sold separately.

**1990 Concealed Vertical Rod Crossbar Exit Devices**

Devices are priced for 3'8" x 7',  
 Aluminum or Hollow Metal Doors.  
 Hex Bottom Latch furnished standard.  
 (Price includes PB48 Strike)

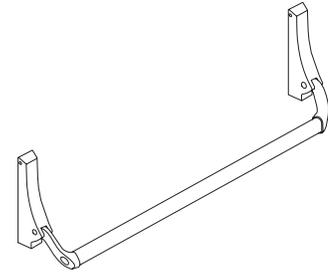

Model No.	US26D	Standard Trim
1990EO	1442	-
1991DT	1884	9970 Pull
1992NL-OP/HB-OP	1548	Rim Cylinder only
1993NL/HB	1990	9970 w/Rim Cylinder

**REFERENCE NOTES:**

Rim cylinder supplied standard with NL and HB options is C keyway.

**Optional Latches**

Suffix		List Add
RL	Rod Bottom Latch	33.00
PL	Pullman Bottom Latch	33.00
ES	Top Latch for use with Electric Strikes Device Furnished LBR (Less Bottom Rod and Less Strike) <b>deduct \$27.00 List</b>	37.00

**Door Heights over 7'**

	List Add
Up to 8'	75.00
Up to 9'	95.00
Up to 10'	110.00

**Crossbar**

	List Add
Crossbar furnished 41" standard - Easily Cut for Job Fitting	
Extra Length Crossbar - 48" (Fits Door Width up to 51") - P28, P13, P35 finishes	23.00
Extra Length Crossbar - 48" (Fits Door Width up to 51") - Architectural finishes	33.00
Less Crossbar, <b>deduct \$137 List</b>	

**REFERENCE NOTES:**

Specify if Door Material other than Aluminum. Not recommended for use on wood doors.

**2090 Rim Type Crossbar Exit Devices**

**Devices are priced for 3'8", Aluminum or Hollow Metal Doors.**

(Price includes SD36 Strike)

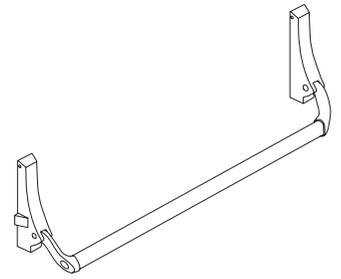

<b>Model No.</b>	<b>US26D</b>	<b>Standard Trim</b>
2090EO	1336	-
2091DT	1778	9970 Pull
2092NL-OP/HB-OP	1442	Rim Cylinder only
2093NL/HB	1884	9970 w/Rim Cylinder

**REFERENCE NOTES:**

Rim cylinder supplied standard with NL and HB options is C keyway.

**Crossbar**

	<b>List Add</b>
Crossbar furnished 41" standard - Easily Cut for Job Fitting	
Extra Length Crossbar - 48" (Fits Door Width up to 51") - P28, P13, P35 finishes	23.00
Extra Length Crossbar - 48" (Fits Door Width up to 51") - Architectural finishes	33.00
Less Crossbar, <b>deduct \$136 List</b>	

**REFERENCE NOTES:**

Specify if Door Material other than Aluminum. Specify Handing RHR or LHR. Not Reversible.

Surface Door Closers

1250 Series Surface Door Closers

- Light duty cast aluminum door closer
- Adjustable sizes 1-5
- ANSI/BHMA 156.4, Grade 1 certified
- Closers without Hold-Open arms are UL 10C fire rated

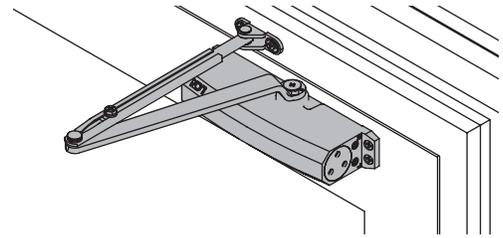

Series	Arms	Finish	Handing	Cylinder Assembly	Cover	Price Ea.
1250	⊗	Rw/PA	-	Std	None	\$243.00
1250	⊗	Rw/PA	-	Std	Slim	260.00
1250	⊗	Hw/PA	-	Std	None	276.00
1250	⊗	Hw/PA	-	Std	Slim	293.00
1250	⊗	Rw/PA	-	Std	None	243.00
1250	⊗	Rw/PA	-	Std	Slim	260.00
1250	⊗	Hw/PA	-	Std	None	276.00
1250	⊗	Hw/PA	-	Std	Slim	293.00

1260 Series Surface Door Closers

- Light-medium duty cast iron door closer
- Adjustable sizes 1-5
- ANSI/BHMA 156.4, Grade 1 certified
- Closers without Hold-Open arms are UL 10C fire rated

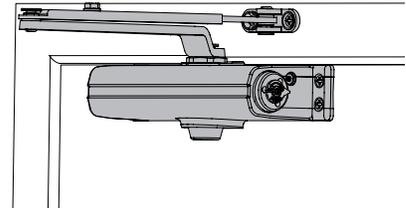

Series	Arms	Finish	Handing	Cylinder Assembly	Cover	Price Ea.
1261	⊗	Rw/PA	-	Std	None	\$338.00
1261	⊗	Hw/PA	-	Std	None	372.00
1261	⊗	Rw/PA	-	Std	None	338.00
1261	⊗	Hw/PA	-	Std	None	372.00

1450 Series Surface Door Closers

- Medium duty cast aluminum door closer
- Adjustable sizes 1-6
- ANSI/BHMA 156.4, Grade 1 certified
- Closers without Hold-Open arms are UL 10C fire rated

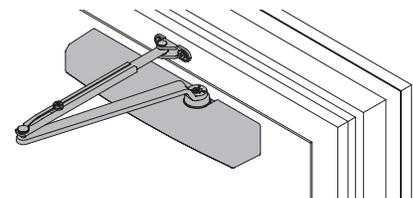

Series	Arms	Finish	Handing	Cylinder Assembly	Cover	Price Ea.
1450	⊗	Rw/PA	-	Std	Slim	\$322.00
1450	⊗	Rw/PA	-	Std	Full	334.00
1450	⊗	Hw/PA	-	Std	Slim	355.00
1450	⊗	Hw/PA	-	Std	Full	367.00
1450	⊗	Rw/PA	-	Std	Slim	322.00
1450	⊗	Rw/PA	-	Std	Full	334.00
1450	⊗	Hw/PA	-	Std	Slim	355.00
1450	⊗	Hw/PA	-	Std	Full	367.00

Notes: **AL** = Aluminum finish (689); **DKBRZ** = Dark bronze finish (695); **Rw/PA** = Regular arm with parallel arm bracket  
**Hw/PA** = Hold open arm with parallel arm bracket (Please note hold open arm configurations are not UL listed.)

Surface Door Closers (continued)

1460 Series Surface Door Closers

- Medium duty cast iron door closer
- Adjustable sizes 1-6
- ANSI/BHMA 156.4, Grade 1 certified
- Closers without Hold-Open arms are UL 10C fire rated

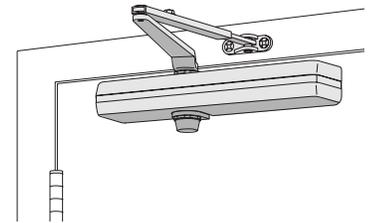

Series		Arms	Finish	Handing	Cylinder Assembly	Cover	Price Ea.
1461	☺	Rw/PA	AL	-	Std	Slim	\$425.00
1461	☹	Rw/PA	AL	-	Std	Full	437.00
1461	☺	Hw/PA	AL	-	Std	Slim	459.00
1461	☹	Hw/PA	AL	-	Std	Full	471.00
1461	☺	Rw/PA	DKBRZ	-	Std	Slim	425.00
1461	☹	Rw/PA	DKBRZ	-	Std	Full	437.00
1461	☺	Hw/PA	DKBRZ	-	Std	Slim	459.00
1461	☹	Hw/PA	DKBRZ	-	Std	Full	471.00

4040XP Series Surface Door Closers

- Heavy duty cast iron door closer
- Adjustable sizes 1-6
- ANSI/BHMA 156.4, Grade 1 certified
- Closers without Hold-Open arms are UL 10C fire rated

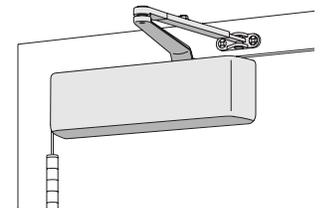

Series		Arms	Finish	Handing	Cylinder Assembly	Cover	Price Ea.
4040XP	☺	Rw/PA	AL	-	Std	Full	602.00
4040XP	☹	Hw/PA	AL	-	Std	Full	676.00
4040XP	☺	EDA	AL	-	Std	Full	647.00
4040XP	☹	Cush	AL	-	Std	Full	682.00
4040XP	☺	SCUSH	AL	-	Std	Full	768.00
4040XP	☹	Rw/PA	DKBRZ	-	Std	Full	602.00
4040XP	☺	Hw/PA	DKBRZ	-	Std	Full	676.00
4040XP	☹	EDA	DKBRZ	-	Std	Full	647.00
4040XP	☺	Cush	DKBRZ	-	Std	Full	682.00
4040XP	☹	SCUSH	DKBRZ	-	Std	Full	768.00

4050A Series Surface Door Closers

- Heavy duty cast aluminum door closer
- Adjustable sizes 1-6
- ANSI/BHMA 156.4, Grade 1 certified
- Closers without Hold-Open arms are UL 10C fire rated

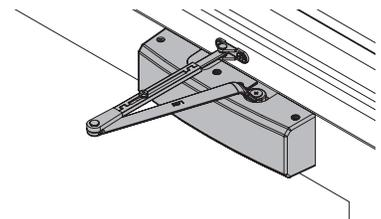

Series		Arms	Finish	Handing	Cylinder Assembly	Cover	Price Ea.
4050A	☺	Rw/PA	AL	-	Std	Full	\$501.00
4050A	☹	Hw/PA	AL	-	Std	Full	575.00
4050A	☺	EDA	AL	-	Std	Full	546.00
4050A	☹	Cush	AL	-	Std	Full	580.00
4050A	☺	SCUSH	AL	-	Std	Full	663.00
4050A	☹	Rw/PA	DKBRZ	-	Std	Full	501.00
4050A	☺	Hw/PA	DKBRZ	-	Std	Full	575.00
4050A	☹	EDA	DKBRZ	-	Std	Full	546.00
4050A	☺	Cush	DKBRZ	-	Std	Full	580.00
4050A	☹	SCUSH	DKBRZ	-	Std	Full	663.00

Notes: **ALUM** = Aluminum painted finish (689); **DKBRZ** = Dark bronze finish (695); **Rw/PA** = Regular arm with parallel arm bracket  
**Hw/PA** = Hold open arm with parallel arm bracket (Please note hold open arm configurations are not UL listed.)  
**EDA** = Extra Duty Parallel Arm; **CUSH** = Cush-n-stop; **SCUSH** = Spring cush-n-stop

## Parts and Components

Series	Number	Product Description	Finish	List Price
1250	18	Drop Plate	ALUM	\$67.00
1250	18PA	Drop Plate - PA	ALUM	67.00
1250	18	Drop Plate	DKBRZ	67.00
1250	18PA	Drop Plate - PA	DKBRZ	67.00
1260	18	Drop Plate	ALUM	68.00
1260	18PA	Drop Plate - PA	ALUM	68.00
1260	18	Drop Plate	DKBRZ	68.00
1260	18PA	Drop Plate - PA	DKBRZ	68.00
1450	18	Drop Plate	ALUM	67.00
1450	18PA	Drop Plate - PA	ALUM	67.00
1450	18FC	Drop Plate (for Full Cover)	ALUM	67.00
1450	18PAFC	Drop Plate - PA (for Full Cover)	ALUM	67.00
1450	18	Drop Plate	DKBRZ	67.00
1450	18PA	Drop Plate - PA	DKBRZ	67.00
1450	18FC	Drop Plate (for Full Cover)	DKBRZ	67.00
1450	18PAFC	Drop Plate - PA (for Full Cover)	DKBRZ	67.00
1460	18	Drop Plate	ALUM	68.00
1460	18PA	Drop Plate - PA	ALUM	68.00
1460	18FC	Drop Plate (for Full Cover)	ALUM	68.00
1460	18PAFC	Drop Plate - PA (for Full Cover)	ALUM	68.00
1460	18	Drop Plate	DKBRZ	68.00
1460	18PA	Drop Plate - PA	DKBRZ	68.00
1460	18FC	Drop Plate (for Full Cover)	DKBRZ	68.00
1460	18PAFC	Drop Plate - PA (for Full Cover)	DKBRZ	68.00
4050A	18	Drop Plate	ALUM	67.00
4050A	18PA	Drop Plate PA	ALUM	67.00
4050A	18	Drop Plate	DKBRZ	67.00
4050A	18PA	Drop Plate PA	DKBRZ	67.00

Notes: **AL** = Aluminum finish (689); **DKBRZ** = Dark bronze finish (695)

**Automatic Operators**

**4600 Series Auto Equalizer**

- Heavy duty electro hydraulic automatic operator
- Used when door is operated manually most of the time with occasional automatic opening
- ANSI/BHMA 156.19, UL 10C, UL 325

Series	Mounting	Arms	Finish	Handing	Cylinder Assembly	Cover	List Price
4630		Track	AL	-	Std	Metal	\$6,683.00
4630		Track	DKBRZ	-	Std	Metal	6,683.00
4642		Reg	AL	-	Std	Metal	6,597.00
4642		Reg	DKBRZ	-	Std	Metal	6,597.00

**9100 Series Benchmark**

- Medium duty electromechanical automatic operator
- Used when door is operated electronically most of the time
- ANSI/BHMA 156.19, UL 325

Series	Mounting	Arms	Finish	Handing	Cylinder Assembly	Cover	List Price
9130		Track	AL	-	Std	Metal	\$4,023.00
9130		Track	DKBRZ	-	Std	Metal	4,023.00
9140		Std	AL	-	Std	Metal	3,946.00
9140		Std	DKBRZ	-	Std	Metal	3,946.00

**9500 Series Senior Swing**

- Heavy duty electromechanical automatic operator
- Used when door is operated electronically most of the time
- ANSI/BHMA 156.19, UL 325, UL 10C

Series	Mounting	Arms	Finish	Handing	Cylinder Assembly	Cover	List Price
9530		Track	AL	RH	Std	Metal	\$5,661.00
9530		Track	AL	LH	Std	Metal	5,661.00
9530		Track	DKBRZ	RH	Std	Metal	5,661.00
9530		Track	DKBRZ	LH	Std	Metal	5,661.00
9540		Std	AL	RH	Std	Metal	5,564.00
9540		Std	AL	LH	Std	Metal	5,564.00
9540		Std	DKBRZ	RH	Std	Metal	5,564.00
9540		Std	DKBRZ	LH	Std	Metal	5,564.00

## General Closer Information

### Surface Mount SC Series

#### Certifications and Listings

1. SC60A, SC70A and SC80A Series Closers are certified to meet the requirements of ANSI Standard A156.4, Grade 1.
2. SC90A Series Closers are certified to meet the requirements of ANSI Standard A156.4, Grade 3.
3. SC60A, SC70A, SC80A, and SC90A Series Closers without hold-open arms are UL10C fire rated.
4. SC61A, SC71A, SC81A, and SC91A Series are designed to meet the American Disabilities Act (ADA) and ANSI A117.1.
5. SC93A (spring size 3) and SC94A (spring size 4) Series do not meet ADA force requirements.

#### Covers and Hardware:

1. SC80A Series Closers ship with a standard SLIM cover unless an optional FULL (FC) cover is added to the order line.
2. SC60A Series Closers ship as LESS cover unless an optional SLIM cover is added to the order line.
3. SC90A Series Closers ship LESS cover unless an option SLIM cover is added to order line.
4. ALL SC60A/70A/80A/93A/94A closer series are furnished with TBWMS and Self-Reaming and Tapping Screws.

#### Master Cartons

1. SC60A and SC80A RWPA are packed with six (6) identical closers per master carton. SC60A and SC80A HWP, DS, DSHO, HD, SS, and SSHO arms are packed 4 per master carton.
2. SC70A Series Closers are packed with four (4) identical closers per master carton.

### Closer Finishes

Finish Code	BHMA	Finish Color Description
MTBK	622	Matte Black
AL	689	Silver Painted (Resembles Aluminum Finish)
DKB	695	Dark Bronze Painted (Spray Duranodic)

## Surface Closer (SC) Options

Falcon has several options to meet your unique application and/or installation needs. See the options section on each series page in the Falcon Closer price list for available options by series. Please contact **Falcon Closer Customer Care at (877) 671-7011** for additional information. As always, we appreciate your business!

### Cylinder Options

- **STD – Standard Cylinder.** Cylinder will provide consistent door control throughout the opening & closing cycle. Independent backcheck, main speed and latch speed are field adjustable regulation valves and incorporated into the cylinder.
- **DEL – Delay Action Cylinder.** Cylinder will provide consistent door control throughout the opening & closing cycle but includes an extra regulation valve that allows the door to slowly close (delay) as it begins to send the door back to latch (approximately 70°). Independent backcheck, main speed and latch speed are field adjustable regulation valves and incorporated into the cylinder.

### Cover Options

- **STD – Standard Cover.** Cover will enclose the cylinder body with the exception of the unused pinion shaft. A shaft cover will be included to cover the unused pinion shaft.
- **SLIM – Slim Cover.** Cover will enclose the cylinder body with the exception of the unused pinion shaft. A shaft cover will be included to cover the unused pinion shaft.
- **FULL – Full Cover.** Cover will enclose the entire cylinder body, including the unused pinion shaft.

### Arm Options

- **Rw/PA – Regular Arm with Parallel Arm Bracket.** Includes adjustable forearm assembly to accommodate a variety of door types and frame conditions. Parallel Arm (PA) bracket allows closer to be installed on the 'push' side of the door in a parallel arm type configuration.
- **Hw/PA – Hold Open Arm with Parallel Arm Bracket.** Includes adjustable forearm assembly to accommodate a variety of door types and frame conditions. Parallel Arm (PA) bracket allows closer to be installed on the 'push' side of the door in a parallel arm type configuration. Hold open function adjustable at the arm shoe.
- **HD/PA – Heavy Duty Arm with Parallel Arm Bracket.** Includes a stamped steel main arm and forearm for added durability in potentially high traffic and/or abusive applications. Parallel Arm (PA) bracket is a permanent feature, installation on 'push' side of the door in a parallel arm type configuration is required.

- **FA – Forged Arm.** Extra heavy duty arm with parallel arm bracket. Includes a forged steel main arm and forearm for maximum durability in high traffic and/or abusive applications. Parallel Arm (PA) bracket is a permanent feature, installation on 'push' side of the door in a parallel arm type configuration is required.
- **FA/HO – Forged Arm with Hold Open.** Extra heavy duty arm with parallel arm bracket that incorporates a hold open feature. Includes a forged steel main arm and forearm for maximum durability in high traffic and/or abusive applications. Parallel Arm (PA) bracket is a permanent feature, installation on 'push' side of the door in a parallel arm type configuration is required.
- **DS – Dead Stop Arm.** Heavy duty arm with parallel arm bracket that incorporates a positive mechanical stop. Includes a stamped steel main arm and forearm for added durability in potentially high traffic and/or abusive applications. Parallel Arm (PA) bracket is a permanent feature, installation on 'push' side of the door in a parallel arm type configuration is required.
- **DS/HO – Dead Stop Arm with Hold Open.** Heavy duty arm with parallel arm bracket that incorporates a positive mechanical stop and hold open feature. Includes a stamped steel main arm and forearm for added durability in potentially high traffic and/or abusive applications. Parallel Arm (PA) bracket is a permanent feature, installation on 'push' side of the door in a parallel arm type configuration is required. Hold open function is manually selected with a 'thumb turn' feature built into the main portion of the arm.
- **SS – Spring-n-Stop Arm.** Extra heavy duty arm with parallel arm bracket that incorporates an integral spring stop. Includes a forged steel main arm and forearm for maximum durability in high traffic and/or abusive applications. Parallel Arm (PA) bracket is a permanent feature, installation on 'push' side of the door in a parallel arm type configuration is required.
- **SS/HO – Spring-n-Stop Arm with Hold Open.** Extra heavy duty arm with parallel arm bracket that incorporates an integral spring stop and hold open feature. Includes a forged steel main arm and forearm for maximum durability in high traffic and/or abusive applications. Parallel Arm (PA) bracket is a permanent feature, installation on 'push' side of the door in a parallel arm type configuration is required.

RwPA

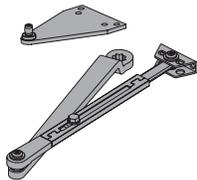

HwPA

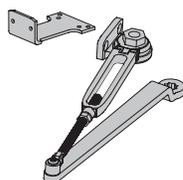

HDPA



FA

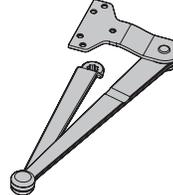

FAHO

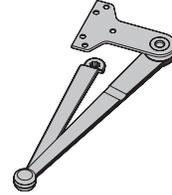

DS

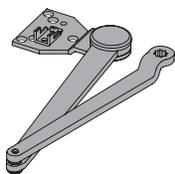

DSHO



SS

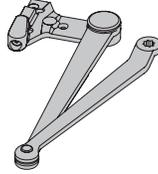

SSHO

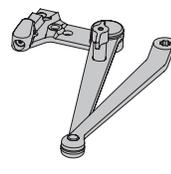

### Fastener Pack Option

- **TBWS – Through Bolt, Wood & Machine Screws.** Fasteners for installation on wood, hollow metal or aluminum store front type doors. Through bolts for installations on 1¾" thick, hollow core doors are included. SC60A/SC70A/SC80A/SC93A/SC94A faster pack will contain TBWS and Self-Reaming and Tapping Screws

### ADA Accessibility Requirements

- **Product Information – Closers are preset for standard spring power or can be adjusted in the field to generate the 5lbs. of opening force (36" wide, interior door) requirements for ADA (Sections 4.13.10 and/or 4.13.11) and the ANSI Standard A117.1 (Sections 4.13.10 and/or 4.13.11).**

SC60A Series Closers

SC60A Series

Light-Medium Duty

Model	Arm Type	Shipping Weight	AL (689) DKB (695) MTBK (622) <sup>1</sup>
SC61A	RwPA	7	\$194
SC61A	HwPA	7	222
SC61A	HDPA <sup>1</sup>	7	222
SC61A	DS	9	245
SC61A	DSHO <sup>1</sup>	9	271
SC61A	SS <sup>1</sup>	9	323
SC61A	SSHO <sup>1</sup>	9	343

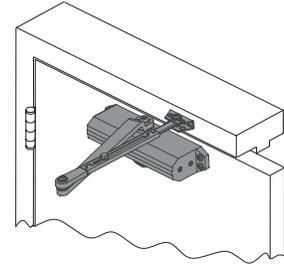

60A Series

REFERENCE NOTES:

- 1) SC61A HD, DS/HO, SS, and SS/HO are not available in matte black.
- 2) SC61A ships standard as LESS cover.
- 3) SC61A is fully adjustable 1-5

Closer Options

Suffix	Description	List Adder
SLIM	SLIM Cover	\$17

Closer Parts and Accessories

Model	Description	Shipping Weight	List
SC61A-3071	Standard Cylinder	9	\$120
SC60A-72	Slim Cover	1	17
SC60A-3077/PA	Regular Arm w/ PA Bracket	3	75
SC60A-3049/PA	Hold Open Arm w/ PA Bracket	3	103
SC60A-3077HD	Heavy Duty Parallel Arm <sup>1</sup>	3	103
SC60A-3077DS	Dead Stop Parallel Arm	5	123
SC60A-3049DS	Hold Open Dead Stop Parallel Arm <sup>1</sup>	5	151
SC60A-3077SS	Spring N Stop Arm <sup>1</sup>	5	202
SC60A-3049SS	Hold Open Spring N Stop Arm <sup>1</sup>	5	225
SC60A-18	Mounting Plate - Top Jamb	2	38
SC60A-18PA	Mounting Plate - Push Side	2	38
SC60A-30	Cush Shoe Support	1	25
SC60A-61	Blade Stop Spacer	1	29
SSC60A-62A	Offset Auxiliary Shoe	1	33

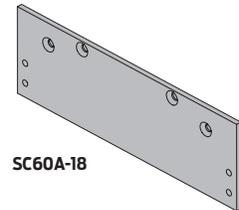

SC60A-18

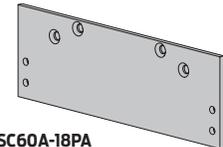

SC60A-18PA

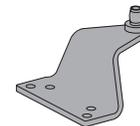

SC60A-62A

REFERENCE NOTES:

- 1) SC61A, HD, DS/HO, SS, and SS/HO arms are not available in matte black.
- 2) Matte Black and Dark Bronze Closers share the same screw finish.

### SC70A Series Closers

#### SC70A Series

Heavy Duty

Model	Arm Type	Shipping Weight	AL (689) DKB (695) MTBK (622) <sup>1</sup>
SC71A	RwPA	10	\$383
SC71A	HwPA	10	409
SC71A	HDPA	11	409
SC71A	FAI	11	429
SC71A	FAHO <sup>1</sup>	11	458
SC71A	DS	11	431
SC71A	DSHO <sup>1</sup>	12	460
SC71A	SS <sup>1</sup>	12	511
SC71A	SSHO <sup>1</sup>	12	532

#### REFERENCE NOTES:

- 1) SC71 FA, FA/HO, DS/HO, SS, and SS/HO are not available in matte black.
- 2) SC71 ships standard with a FULL Cover.
- 3) SC71 is fully adjustable 1-6

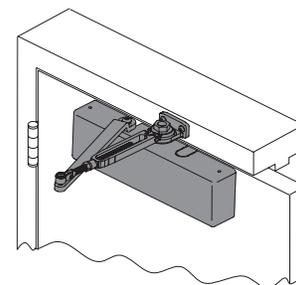

SC70A Series

#### Closer Parts and Accessories

Model	Description	Shipping Weight	List
SC71A-3071	Standard Cylinder	12	\$287
SC71A-3071DEL	Delay Cylinder <sup>1</sup>	12	328
SC70A-72	FULL Cover	1	21
SC70A-3077/PA	Regular Arm w/ PA Bracket	3	75
SC70A-3049/PA	Hold Open Arm w/ PA Bracket	3	103
SC70A-3077HD	Heavy Duty Parallel Arm	3	103
SC70A-3077FA	Forged Parallel Arm <sup>1</sup>	3	121
SC70A-3049FA	Hold Open Forged Parallel Arm <sup>1</sup>	3	148
SC70A-3077DS	Dead Stop Parallel Arm	5	123
SC70A-3049DS	Hold Open Dead Stop Parallel Arm <sup>1</sup>	5	151
SC70A-3077SS	Spring N Stop Arm <sup>1</sup>	5	202
SC70A-3049SS	Hold Open Spring N Stop Arm <sup>1</sup>	5	225
SC70A-18	Narrow Frame Back Plate	3	66
SC70A-18PA	Narrow Top Rail Drop Plate	4	66
SC70A-30	Cush Shoe Support	1	25
SC70A-61	Blade Stop Spacer	1	29
SC70A-62A	Offset Auxiliary Shoe	1	33

#### REFERENCE NOTE:

- 1) SC71A FA, FA/HO, DS/HO, SS, and SS/HO arms are not available in matte black.
- 2) Matte Black and Dark Bronze Closers share the same screw finish.

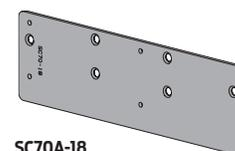

SC70A-18

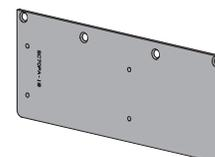

SC70A-18PA

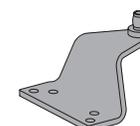

SC70A-62A

SC80A Series Closers

SC80A Series

Medium Duty

Model	Arm Type	Shipping Weight	AL (689) DKB (695) MTBK (622) <sup>1</sup>
SC81A	RwPA	8	\$245
SC81A	HwPA	8	270
SC81A	HDPA <sup>1</sup>	10	270
SC81A	DS	10	294
SC81A	DSHO <sup>1</sup>	10	320
SC81A	SS <sup>1</sup>	10	373
SC81A	SSHO <sup>1</sup>	10	393

REFERENCE NOTES:

- 1) SC81A ships standard with a SLIM Cover.
- 2) SC81A is fully adjustable 1-6

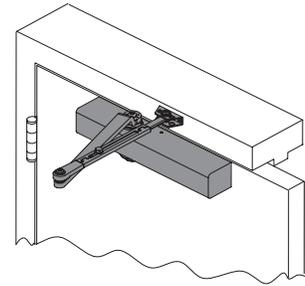

SC80A  
(w/ full cover shown)

Closer Options

Suffix	Description	List Adder
FC	FULL Cover	\$8

Closer Parts and Accessories

Model	Description	Shipping Weight	List
SC81A-3071	Standard Cylinder	10	\$157
SC80A-72	Slim Cover	1	13
SC81A-72FC	FULL Cover	1	21
SC81A-3077/PA	Regular Arm w/ PA Bracket	3	75
SC81A-3049/PA	Hold Open Arm w/ PA Bracket	3	103
SC81A-3077HD	Heavy Duty Parallel Arm <sup>1</sup>	3	103
SC81A-3077DS	Dead Stop Parallel Arm	5	123
SC81A-3049DS	Hold Open Dead Stop Parallel Arm <sup>1</sup>	5	151
SC81A-3077SS	Spring N Stop Arm <sup>1</sup>	5	202
SC81A-3049SS	Hold Open Spring N Stop Arm <sup>1</sup>	5	225
SC81A-18	Mounting Plate - Top Jamb	2	38
SC81A-18FC	Mounting Plate - Top Jamb for FULL Cover	2	38
SC81A-18PA	Mounting Plate - PA	2	38
SC81A-18PAFC	Mounting Plate - PA for FULL Cover	2	38
SC81A-30	Cush Shoe Support	1	25
SC81A-61	Blade Stop Spacer	1	29
SC81A-62A	Offset Auxiliary Shoe	1	33

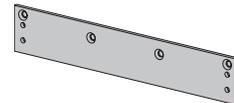

SC80A-18

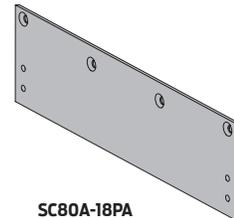

SC80A-18PA

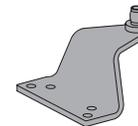

SC80 A-62A

REFERENCE NOTE:

- 1) SC80A delay action, HD, DS/HO, SS, and SS/HO arms are not available in matte black.
- 2) Matte Black and Dark Bronze Closers share the same screw finish.

### SC90A Series Closers

#### SC90A Series

Light- Residential Duty

Model	Arm Type	Size	Shipping Weight	AL (689) DKB (695)
SC91A	RwPA	1	5	\$143
SC91A	HwPA	1	5	169
SC93A	RwPA	3	5	143
SC93A	HwPA	3	5	169
SC94A	RwPA	4	5	143
SC94A	HwPA	4	5	169

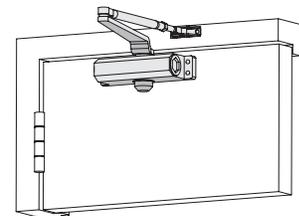

SC90A Series

#### REFERENCE NOTES:

- 1) SC90 series ship standard as LESS Cover.
- 2) \*Brass will not be available with SC91A/SC93A/SC94A.

#### Closer Options

Suffix	Description	List Adder
STD	Standard Cover (Only fits 93 and 94 models)	\$20

#### Closer Parts and Accessories

Model	Description	Shipping Weight	List
SC90A-18	Mounting Plate - Top Jamb	2	\$38
SC90A-18PA	Mounting Plate - Push Side	2	38

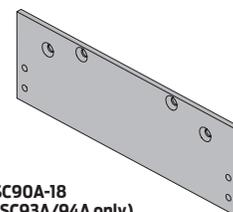

SC90A-18  
(SC93A/94A only)

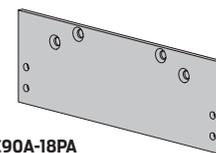

SC90A-18PA  
(SC93A/94A only)

## Architectural Door Hinges



3CB1

## Architectural Hinges

Number	Description	Finish	Price Each
3CB1 4.5x4.5	3 Knuckle Plain Bearing	US26D (652)	\$17.20
3CB1 4.5x4.5	3 Knuckle Concealed Bearing	US32D (630)	77.90
3CB1 4.5x4.5 NRP	3 Knuckle Concealed Bearing NRP	US26D (652)	22.70
3CB1 4.5x4.5 NRP	3 Knuckle Concealed Bearing NRP	US32D (630)	83.40
3CB1 HW 4.5x4.5	3 Knuckle Concealed Bearing Heavy Wt.	US26D (652)	56.50
3CB1 HW 4.5x4.5 NRP	3 Knuckle Concealed Bearing Heavy Wt. NRP	US26D (652)	62.00
3CB1 HW 4.5x4.5 NRP	3 Knuckle Concealed Bearing Heavy Wt. NRP	US32D (630)	124.90
3CB1 HW 5x4.5	3 Knuckle Concealed Bearing Heavy Wt.	US26D (652)	70.70
3SP1 4.5x4.5	3 Knuckle Spring	US26D (652)	30.70
5PB1 4.5x4.5	5 Knuckle Plain Bearing	US26D (652)	10.80
5PB1 4.5x4.5 NRP	5 Knuckle Plain Bearing NRP	US26D (652)	16.30
5BB1 4.5x4	5 Knuckle Ball Bearing	US26D (652)	20.30
5BB1 4.5x4 NRP	5 Knuckle Ball Bearing NRP	US26D (652)	25.80
5BB1 4.5x4.5	5 Knuckle Ball Bearing	US26D (652)	15.10
5BB1 4.5x4.5	5 Knuckle Ball Bearing	US32D (630)	55.30
5BB1 4.5x4.5	5 Knuckle Ball Bearing	USP (600)	14.60
5BB1 4.5x4.5	5 Knuckle Ball Bearing	US10B (613)	76.40
5BB1 4.5x4.5	5 Knuckle Ball Bearing	US15 (619)	69.40
5BB1 4.5x4.5	5 Knuckle Ball Bearing	US3 (632)	23.50
5BB1 4.5x4.5	5 Knuckle Ball Bearing	US4 (633)	18.50
5BB1 4.5x4.5	5 Knuckle Ball Bearing	US10 (639)	20.60
5BB1 4.5x4.5	5 Knuckle Ball Bearing	US10B (640)	29.40
5BB1 4.5x4.5	5 Knuckle Ball Bearing	US15 (646)	28.10
5BB1 4.5x4.5	5 Knuckle Ball Bearing	US26 (651)	23.50
5BB1 4.5x4.5 NRP	5 Knuckle Ball Bearing NRP	US26D (652)	20.60
5BB1 4.5x4.5 NRP	5 Knuckle Ball Bearing NRP	US32D (630)	60.80
5BB1 4.5x4.5 NRP	5 Knuckle Ball Bearing NRP	USP (600)	20.10
5BB1 4.5x4.5 NRP	5 Knuckle Ball Bearing NRP	US10B (613)	87.40
5BB1 4.5x4.5 NRP	5 Knuckle Ball Bearing NRP	US15 (619)	80.40
5BB1 4.5x4.5 NRP	5 Knuckle Ball Bearing NRP	US10B (640)	34.90
5BB1 4.5x4.5 NRP	5 Knuckle Ball Bearing NRP	US15 (646)	33.60
5BB1 5x4.5	5 Knuckle Ball Bearing	US26D (652)	31.90
5BB1 5x4.5 NRP	5 Knuckle Ball Bearing NRP	US26D (652)	42.90
5BB1 5x4.5 NRP	5 Knuckle Ball Bearing NRP	US32D (630)	81.40
5BB1 HW 4.5x4.5	5 Knuckle Ball Bearing Heavy Wt.	US26D (652)	43.80
5BB1 HW 4.5x4.5	5 Knuckle Ball Bearing Heavy Wt.	US32D (630)	90.60
5BB1 HW 4.5x4.5 NRP	5 Knuckle Ball Bearing Heavy Wt. NRP	US26D (652)	49.30
5BB1 HW 4.5x4.5 NRP	5 Knuckle Ball Bearing Heavy Wt. NRP	US32D (630)	96.10
5BB1 HW 4.5x4.5 NRP	5 Knuckle Ball Bearing Heavy Wt. NRP	US10B (613)	138.00
5BB1 HW 4.5x4.5 NRP	5 Knuckle Ball Bearing Heavy Wt. NRP	US15 (619)	117.80
5BB1 HW 5x4.5	5 Knuckle Ball Bearing Heavy Wt.	US26D (652)	50.40
5BB1 HW 5x4.5	5 Knuckle Ball Bearing Heavy Wt.	US32D (630)	105.90
5BB1 HW 5x4.5 NRP	5 Knuckle Ball Bearing Heavy Wt. NRP	US26D (652)	61.40
5BB1 HW 5x4.5 NRP	5 Knuckle Ball Bearing Heavy Wt. NRP	US32D (630)	116.90
5BB1 SC 4.5	5 Knuckle Ball Bearing Swing Clear	US26D (652)	86.00
5BB1 HW BSC 4.5	5 Knuckle Ball Bearing Heavy Wt. Beveled Swing Clear Heavy Wt.	US26D (652)	104.30
5BB1 HW BSC 5	5 Knuckle Ball Bearing Heavy Wt. Beveled Swing Clear Heavy Wt.	US26D (652)	104.30

## Continuous Hinges

Number	Description	Finish	Price Each
112HD 83"	Continuous Geared, Heavy Duty 83" Length	US28	\$221.60
224HD 83"	Continuous Geared with Edge Protector, Heavy Duty, 83"	US28	236.40
700 83"	Continuous Pin & Barrel, 83"	US32D	688.40
700 95"	Continuous Pin & Barrel, 95"	US32D	797.00
705 83"	Continuous Pin & Barrel, Full Wrap, 83"	US32D	898.20

**Pivots**

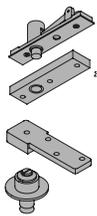

**7253**

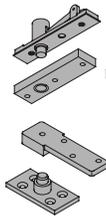

**7255**

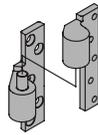

**7215-7226-7227 INT**

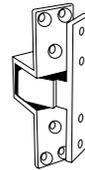

**91105F**

**Pivot Set**

Number	Description	Handing	Finish	Price Each
7215 SET RH	3/4" Offset Pivot Set, 500 lb	RH	US26D	\$528.60
7215 SET LH	3/4" Offset Pivot Set, 500 lb	LH	US26D	528.60
7226 SET	3/4" Offset Pivot Set, 600 lb	-	US26D	505.50
7230F SET	3/4" Offset Pivot Set, 1000 lb, Fire Rated	-	US32D	943.80
7253 SET	Center Hung Pivot Set, 300 lb	-	US26D	418.50
7255 SET	Center Hung Pivot Set, 500 lb	-	US26D	461.40

Note: Set includes top-and-bottom pivots.

**Intermediate Pivots**

Number	Description	Handing	Finish	Price Each
7215-7226-7227 INT RH	3/4" Offset Intermediate Pivot for 7215, 7226 and 7227	RH	US26D	\$285.70
7215-7226-7227 INT LH	3/4" Offset Intermediate Pivot for 7215, 7226 and 7227	LH	US26D	285.70
7230F-7237F INT RH	3/4" Offset Intermediate Pivot for 7230F and 7237F, Fire Rated	RH	US32D	528.60
7230F-7237F INT LH	3/4" Offset Intermediate Pivot for 7230F and 7237F, Fire Rated	LH	US32D	528.60

**Pocket Pivot**

Number	Description	Finish	Price Each
91105F	Pocket Pivot, Fire Rated	US32D	\$565.70

Note: Pocket pivots are sold individually.

Floor Stops



FS436



FS185



FS440



FS441



FS444



FS446



FS452



FS544



FS1153



FS1154

Floor Stops, Dome Stops and Kick Downs

Number	Description	Finish	Price Each
FS13	Dome Stop	US26D	\$10.70
FS436	Dome Stop	US26D	7.40
FS436	Dome Stop	US3	8.90
FS436	Dome Stop	US10B	10.20
FS436	Dome Stop	US15	10.20
FS436	Dome Stop	US26	9.20
FS436	Dome Stop	US28	6.80
FS438	Dome Stop for use with Thresholds	US26D	8.30
FS438	Dome Stop for use with Thresholds	US10B	12.00
FS438	Dome Stop for use with Thresholds	US15	15.20
FS438	Dome Stop for use with Thresholds	US26	11.30
FS438	Dome Stop for use with Thresholds	US28	8.20
R435-1/2	1/2" Riser for FS436 Dome Stop	US27	8.40
FS18L	Security Floor Stop, 3 1/2" Bumper	-	21.90
FS18S	Security Floor Stop, 1 1/2" Bumper	-	15.40
FS434	Floor Stop, Angle	US2C	12.00
FS441	Floor Stop	US26D	29.90
FS441	Floor Stop	US10B	32.90
FS441	Floor Stop	US15	42.40
FS444	Floor Stop, Heavy-Duty, Masonry	US26D	35.20
FS444	Floor Stop, Heavy-Duty, Masonry	US10B	43.00
FS444	Floor Stop, Heavy-Duty, Masonry	US15	46.70
FS448	Floor Stop, Heavy-Duty, Drywall/Wood	US26D	41.00
FS448	Floor Stop, Heavy-Duty, Drywall/Wood	US10B	39.60
FS440	Floor Stop w/ Automatic Holder, 1/2" Door to Floor Clearance	US26D	82.40
FS446	Floor Stop w/ Manual Holder, Heavy-Duty, Masonry	US26D	51.40
FS446	Floor Stop w/ Manual Holder, Heavy-Duty, Masonry	US10B	64.30
FS446	Floor Stop w/ Manual Holder, Heavy-Duty, Masonry	US15	66.80
FS450	Floor Stop w/ Manual Holder, Heavy-Duty, Drywall/Wood	US26D	55.90
FS452-4"	Kick Down Holder, 4"	US26D	38.10
FS452-4"	Kick Down Holder, 4"	US15	54.20
FS452-5"	Kick Down Holder, 5"	US26D	47.20
FS452-5"	Kick Down Holder, 5"	US10B	54.70
FS452-5"	Kick Down Holder, 5"	US15	61.70
FS455-4"	Kick Down Holder, 4"	US26D	51.60
FS455-4"	Kick Down Holder, 4"	US3	43.00
FS455-4"	Kick Down Holder, 4"	US10B	51.60
FS455-4"	Kick Down Holder, 4"	US27	10.80
FS455-4"	Kick Down Holder, 4"	US3AL	10.80
FS544-4"	Kick Down Holder, 4"	SP28	15.80
FS544-4"	Kick Down Holder, 4"	SP4	15.80
FS555-5"	Kick Down Holder, 5"	SP28	17.00
FS544/555	Kick Down Holder - Rubber w/ Screw (Use P/N FSPART.1074 when ordering)		4.00
FS1153	Plunger-Type Door Holder — 1 5/8" Throw	US28	64.30
FS1154	Plunger-Type Door Holder — 1 1/4" Throw	US10	115.80

**Wall Stops**



**Wall Stops**

Number	Description	Screw Pkg.	Finish	Price Each
060F26D	Residential, Flexible Door Stop, 3"		F26D	\$1.70
060F10B	Residential, Flexible Door Stop, 3"		F10B	1.70
060F14	Residential, Flexible Door Stop, 3"		F14	1.70
060F15	Residential, Flexible Door Stop, 3"		F15	1.70
63F619E	Residential, Flexible Door Stop, 3"		63F619E	1.30
63F643E/716E	Residential, Flexible Door Stop, 3"		F643E/716E	1.30
60A92	Residential, Solid Door Stop, 3 3/4"		A92	4.70
61A92	Residential, Solid Door Stop, 3 1/8"		A92	4.70
61A10B	Residential, Solid Door Stop, 3 1/8"		A10B	4.70
61A14	Residential, Solid Door Stop, 3 1/8"		A14	4.70
61A15	Residential, Solid Door Stop, 3 1/8"		A15	4.70
61A-W	Residential, Solid Door Stop, 3 1/8"		A-W	5.10
61B15	Residential, Solid Door Stop, 3 1/8"		B15	22.00
60-5/062/70/430	Replacement Rubber Tips for 60, 61, 70 Stops (100/PKG)			112.00
69F14	Hinge Pin Door Stop (70-100 Degree Adjustment)		F14	5.90
69F15	Hinge Pin Door Stop (70-100 Degree Adjustment)		F15	5.90
70A92	Hinge Pin Door Stop (85-125 Degree Adjustment)		A92	3.10
70A-643E/716	Hinge Pin Door Stop (85-125 Degree Adjustment)		A-643E/716	3.60
70A10B	Hinge Pin Door Stop (85-125 Degree Adjustment)		A10B	3.60
70A15	Hinge Pin Door Stop (85-125 Degree Adjustment)		A15	3.60
70B10B	Hinge Pin Door Stop (85-125 Degree Adjustment)		B10B	19.60
70B15	Hinge Pin Door Stop (85-125 Degree Adjustment)		B15	19.60
WS401/402CCV	Wall Bumper, Cast, Concave	Drywall & Wood	US26D	25.80
WS401/402CVX	Wall Bumper, Cast, Convex	Drywall & Wood	US26D	25.80
WS404CVX	Wall Bumper, Compact, Convex	Drywall & Wood	US26D	9.20
WS406/407-CCV	Wall Bumper, Concave	Drywall & Wood	US32D	4.20
WS406/407-CCV	Wall Bumper, Concave	Drywall & Wood	US3	5.30
WS406/407-CCV	Wall Bumper, Concave	Drywall & Wood	US10	6.00
WS406/407-CCV	Wall Bumper, Concave	Drywall & Wood	US10B	6.00
WS406/407-CVX	Wall Bumper, Convex	Drywall & Wood	US32D	4.20
WS406/407-CVX	Wall Bumper, Convex	Drywall & Wood	US10B	6.00
WS406/407-CVX	Wall Bumper, Convex	Drywall & Wood	US15	6.00
411R-W	Wall Bumper, Adhesive Back		R-W	3.90
WS33	Wall Stop	Drywall & Wood	US26D	69.90
WS447	Wall Stop, Heavy-Duty	Drywall & Wood	US26D	52.20
WS445	Wall Stop w/ Manual Holder, Heavy-Duty	Masonry	US26D	91.00
WS40	Wall Stop w/ Automatic Holder	Universal	US26D	138.80
WS45	Wall Stop w/ Automatic Holder	Universal	US26D	193.10
FS495	Wall Stop w/ Automatic Holder		US26D	112.20
CS115-20	Crash Stop	---	US26D	65.00

## Pulls and Protection Plates

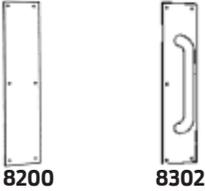

## Kick Plates

Number	Size	Finish	Price Each
8400	8" x 34" B-CS	US32D	\$63.90
8400	10" x 34" B-CS	US32D	79.90
8400	10" x 35" B-CS	US32D	84.50

## Push Plates

Number	Size	Finish	Price Each
8200	Push Plate 3.5x15	US32D	\$23.50
8200	Push Plate 3.5x15	US10B	88.00
8200	Push Plate 3.5x15	US15	50.30
8200	Push Plate 3.5x15	US28	19.10
8200	Push Plate 4x16	US32D	27.40
8200	Push Plate 4x16	US10B	99.50
8200	Push Plate 4x16	US15	56.80
8200	Push Plate 4x16	US26D	54.70
8200	Push Plate 4x16	US28	18.00
8200	Push Plate 6x16	US32D	37.40
8200	Push Plate 8x16	US32D	52.20

## Pull Plates

Number	Size	Center to Center	Finish	Price Each
8302-6	8102 6" Pull and Plate 4x16 1 3/4"	6"	US32D	\$84.80
8302-8	8102 8" Pull and Plate 3.5x15 1 3/4"	8"	US32D	88.60
8302-8	8102 8" Pull and Plate 4x16 1 3/4"	8"	US32D	92.10
8302-0	8102 10" Pull and Plate 3.5x15 1 3/4"	10"	US32D	99.20
8302-0	8102 10" Pull and Plate 4x16 1 3/4"	10"	US32D	102.50
8303-8	8103 8" Pull and Plate 4x16 1 3/4"	8"	US32D	137.50
8303-0	8103 10" Pull and Plate 4x16 1 3/4"	10"	US32D	150.40

## Pulls

Number	Size	Finish	Price Each
221B26D	Flush Pull, Large Circle	B26D	\$5.90
221B10B	Flush Pull, Large Circle	B10B	5.90
221B15	Flush Pull, Large Circle	B15	5.70
222B26D	Flush Pull, Rectangular	B26D	33.10
223B26D	Flush Pull, Oval	B26D	9.90
227B26D	Flush Pull, Deep Well	B26D	15.30
230B26D	Sliding Door Edge Pull	B26D	21.40
990B-613	Sliding Door Pull	B-613	18.00
990B-619	Sliding Door Pull	B-619	18.00
991B-613	Sliding Door Pull - Locking	B-613	25.10
991B-619	Sliding Door Pull - Locking	B-619	25.10
991B-716	Sliding Door Pull - Locking	B-716	25.10
8103HD-0	Straight 10" Pull, Heavy Duty, 1" Diameter	US32D	82.90
8103EZHD-0	Straight 10" Pull, ADA Compliant, Heavy Duty, 1" Diameter	32D-316	114.60

## Offset Door Pulls

Number	Size	Center to Center	Finish	Price Each
8190HD-0	90 Degree Offset 10" Pull, Heavy Duty, 1 3/4"	10"	US32D	\$111.90
8190HD-0	90 Degree Offset 10" Pull, Heavy Duty, 1 3/4"	10"	US10B	226.20
8190HD-0	90 Degree Offset 10" Pull, Heavy Duty, 1 3/4"	10"	US15	178.40
8190HD-2	90 Degree Offset 12" Pull, Heavy Duty, 1 3/4"	12"	US32D	120.70
8190HD-0	90 Degree Offset 10" Pull, Heavy Duty, 1 3/4" (Dec. Thru-Bolt)	10"	US32D	148.90
8190HD-2	90 Degree Offset 12" Pull, Heavy Duty, 1 3/4" (Dec. Thru-Bolt)	12"	US32D	157.70
9190HD-33-0	33" Pushbar/90 Degree Offset 10" Pull, Heavy Duty, 1 3/4"	33", 10"	US32D	356.10

**Vandal Resistant Trim**

**Vandal Resistant Trim**

Number	Description	Finish	Price Each
VR910NL	Vandal Resistant Trim 98/99 Rim or Vertical Rod, Horizontal Keyway	US32D	\$372.70
VR910-DT	Vandal Resistant Trim 98/99 Rim or Vertical Rod, Blank Trim	US32D	372.70

**Flush Bolts & Strikes**

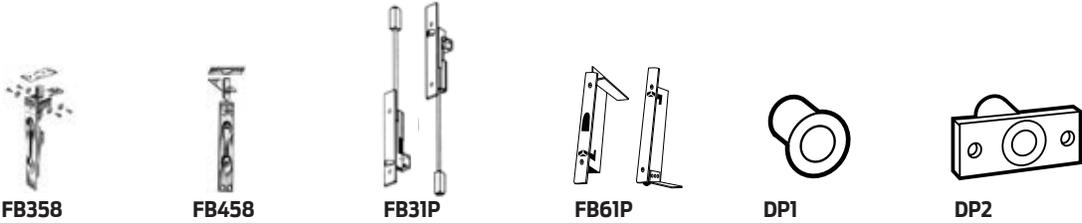

**Flush Bolts**

Number	Description	Door Type	Finish	Price Each
FB358	Manual Flush Bolt, Single Door	Wood	US26D	\$49.80
FB358	Manual Flush Bolt, Single Door	Wood	US10B	49.80
FB358	Manual Flush Bolt, Single Door	Wood	US15	49.80
FB457	Manual Flush Bolt, Single Door	Metal	US26D	37.00
FB458	Manual Flush Bolt, Single Door	Metal	US26D	29.10
FB458	Manual Flush Bolt, Single Door	Metal	US3	31.30
FB458	Manual Flush Bolt, Single Door	Metal	US15	31.30
FB31P	Automatic Flush Bolt, Pair	Metal	US32D	256.50
FB41P	Automatic Flush Bolt, Pair	Wood	US32D	268.30
FB51P	Constant Latching Flush Bolt, Pair	Metal	US32D	256.50
FB61P	Constant Latching Flush Bolt, Pair	Wood	US32D	270.80
262B26D	Manual Flush Bolt		B26D	44.60
262B3	Manual Flush Bolt		B3	38.70
262B10B	Manual Flush Bolt		B10B	44.60
262B	Manual Flush Bolt		B15	44.60
FB256/7/8/457/8/0458-18"	Manual Flush Bolt Rod - 18" (Use P/N 09-161 when ordering)			8.20
FB256/7/8/457/8/0458-24"	Manual Flush Bolt Rod - 24" (Use P/N 09-162 when ordering)			8.20
FB256/7/8/457/8/0458-36"	Manual Flush Bolt Rod - 36" (Use P/N 09-172 when ordering)			8.20

**Dust-Proof Strikes**

Number	Description	Finish	Price Each
DP1	Dust-Proof Strike – Threshold Only	US26D	\$36.30
DP2	Dust-Proof Strike – Floor and/or Threshold	US26D	45.60
DP2	Dust-Proof Strike – Floor and/or Threshold	US10B	45.60

**Coordinators, Lock Guards, & Surface Bolts**

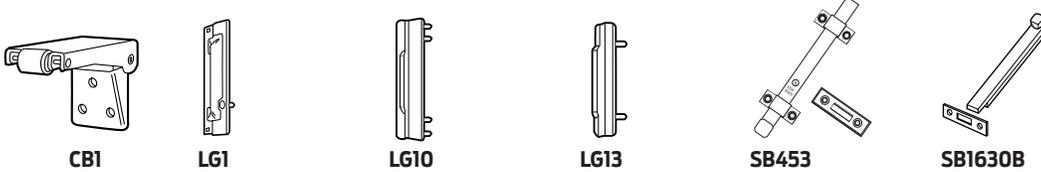

**Coordinators and Accessories**

Number	Description	Finish	Price Each
COR52w/FL 20	Coordinator Bar, 52" Overall Length w/ 20" Filler Bar	US28	\$223.90
COR52	Coordinator Bar, 52" Overall Length	US28	204.60
FL20	Filler Bar, 20" Overall Length	US28	19.30
MB1	Mounting Bracket – Stops over 2 1/2"	SP28	39.50
MB1	Mounting Bracket – Stops over 2 1/2"	USP	27.80
MB2	Mounting Bracket – Stops up to 2 1/2"	SP 28	44.60
MB2	Mounting Bracket – Stops up to 2 1/2"	USP	32.50
CBI	Carry Bar	USP	45.50

**Lock Guards**

Number	Description	Finish	Price Each
LG1	Lock Guard with Security Pin	US32D	\$57.70
LG1	Lock Guard with Security Pin	US2G	25.00
LG10	Lock Guard	US32D	53.80
LG12	Lock Guard	US32D	50.00
LG13	Lock Guard	US32D	48.10
LG14	Lock Guard	US32D	78.80

**Surface Bolts**

Number	Description	Finish	Price Each
40-4 B26D	4" Decorative Surface Bolt, Light Duty	B26D	\$23.20
054B26D	Dutch Door Bolt	B26D	60.80
SB360-12"	12" Surface Bolt, Heavy Duty, Universal Strike	US2C	147.40
SB453-8"-TB	8" Surface Bolt, Top and Bottom Strikes	US2C	53.70
SB1630B	8" Surface Bolt, Bottom Strike	US2G	55.30
SB1630T	8" Surface Bolt, Top Strike	US2G	61.60
SB1630TB	8" Surface Bolt, Top and Bottom Strikes	US2G	72.90

**Latches & Catches**

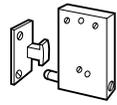

**CL11**

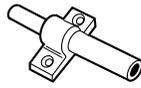

**CL14**



**CL21A**



**RL30**

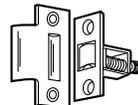

**RL36**

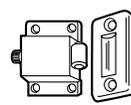

**RL38**

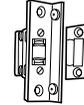

**RL1152**



**SR64**

**Roller Latches, Invisible Latches, and Ball-Type or Cabinet Catch**

Number	Description	Finish	Price Each
RL30	Roller Latch, High traffic	US26D	\$90.10
RL32	Roller Latch, Light-Duty, Mortise	US26D	121.80
RL36	Roller Latch, Light-Duty, Mortise	US32D	68.70
RL38	Roller Latch, Light-Duty, Surface Mounted	US32D	64.80
RL1152	Roller Latch with Angle Stop	US26D	179.50
CL11	Invisible Latch, 7/16" x 1 1/4" x 1 7/8"	US26D	46.30
CL12	Invisible Latch, 9/16" x 1 1/4" x 2 1/4"	US26D	56.50
CL14	Invisible Latch Auxiliary Pusher	US26D	49.10
CL21A	Ball Catch, Four-Way, Full Size Doors	US26D	45.60
CL22	Ball Catch, Three-Way, Smaller Doors	US26D	30.70
325A92	Magnetic Catch, Light Duty, Single Magnet	A92	4.00
326A92	Magnetic Catch, Heavy Duty, Two Magnet	A92	11.40
327A92	Magnetic Catch, Heavy Duty, Four Magnet	A92	19.40
335B10B	Roller Catch, Adjustable	B10B	23.20
336B15	Roller Catch Adjustable	B15	23.20
347B26D	Ball Catch, Square Corners	B26D	19.20
347B10B	Ball Catch, Square Corners	B10B	19.20
347B15	Ball Catch, Square Corners	B15	18.20
347B26	Ball Catch, Square Corners	B26	19.20
349B26D	Ball Catch, Round Corners	B26D	20.10
349B3	Ball Catch, Round Corners	B3	17.00
349B15	Ball Catch, Round Corners	B26	20.80
2A92	Cabinet Catch, Elbow	A92	5.30
2A3	Cabinet Catch, Elbow	A3	5.30
42B10B	Pocket Door Bolt	B10B	21.30
42B15	Pocket Door Bolt	B15	20.50
42B26	Pocket Door Bolt	B26	21.30

**Door Silencers**

Number	Description		Finish	Price Each
SR64	Door Silencers for Metal Frames, Bag of 100	Metal	Gray	\$43.80
SR65	Door Silencer for Wood Frames, Bag of 100	Wood	Gray	43.80

## Miscellaneous Hardware

## Hooks

Number	Description	Finish	Price Each
405	Coat & Hat Hook	A92	\$3.30
571	Coat & Hat Hook	A92	1.70
571	Coat & Hat Hook	A3	1.70
571	Coat & Hat Hook	B10B	12.70
571	Coat & Hat Hook	B15	13.40
572	Coat & Hat Hook	B26D	17.60
580	Ceiling Hook	A92	3.70
581	Wardrobe Hook	A92	2.20
582	Double Wardrobe Hook	A92	2.40
582	Double Wardrobe Hook	B26D	11.50

## Viewer

Number	Description	Finish	Price Each
U696B26D	One Way Viewer, UL Listed	B26D	\$21.10
698	One Way Viewer, Wide Angle	B26D	24.90
U698B26D	One Way Viewer, Wide Angle, UL Listed	B26D	29.70
U698B3	One Way Viewer, Wide Angle, UL Listed	B3	29.70
700B26D	One Way Viewer, Narrow Angle	B26D	10.80
U700B26D	One Way Viewer, Narrow Angle, UL Listed	B26D	14.50

## Door Guard

Number	Description	Finish	Price Each
482	Door Guard, Solid Bar	B26D	\$45.60

## Window Lock

Number	Description	Finish	Price Each
07B3	Window Lock	B3	\$21.50
07B15	Window Lock	US15	27.30

## Handrail Bracket

Number	Description	Finish	Price Each
059A92	Handrail Bracket	A92	\$4.90
059A-BLK	Handrail Bracket	A-BLK	6.40
059A-W	Handrail Bracket	A-W	6.40
59A3	Handrail Bracket	A3	5.00
59A15	Handrail Bracket	A15	6.30
59B15	Handrail Bracket	B15	33.90
59A716	Handrail Bracket	A716	6.30
HB159	Handrail Bracket	US27	22.10

Schlage Residential Barn Door Hardware



**J-Strap**

Description	Finish	Track Length	SKU	Price	Special Order
SD10-6.6 619 JSTP N N SL, Satin Nickel J-Strap	619	6ft 6in	043156002634	\$297.00	
SD10-6.6 622 JSTP N N SL, Black J-Strap	622	6ft 6in	043156002641	\$188.00	
SD10-6.6 630 JSTP N N SL, Stainless Steel J-Strap	630	6ft 6in	043156002658	\$375.00	
SD10-6.6 716 JSTP N N SL, Aged Bronze J-Strap	716	6ft 6in	043156002672	\$290.00	
SD10-8.0 619 JSTP N N SL, Satin Nickel J-Strap	619	8ft	043156002832	\$306.00	
SD10-8.0 622 JSTP N N SL, Black J-Strap	622	8ft	043156002849	\$193.00	
SD10-8.0 630 JSTP N N SL, Stainless Steel J-Strap	630	8ft	043156002856	\$383.00	
SD10-8.0 716 JSTP N N SL, Aged Bronze J-Strap	716	8ft	043156002870	\$287.00	

**Top Mount**

Description	Finish	Track Length	SKU	Price	Special Order
SD10-6.6 619 TMNT N N SL, Satin Nickel Top Mount	619	6ft 6in	043156002788	\$297.00	
SD10-6.6 622 TMNT N N SL, Black Top Mount	622	6ft 6in	043156002795	\$188.00	
SD10-6.6 630 TMNT N N SL, Stainless Steel Top Mount	630	6ft 6in	043156002801	\$375.00	
SD10-6.6 716 TMNT N N SL, Aged Bronze Top Mount	716	6ft 6in	043156002825	\$290.00	
SD10-8.0 619 TMNT N N SL, Satin Nickel Top Mount	619	8ft	043156002986	\$306.00	
SD10-8.0 622 TMNT N N SL, Black Top Mount	622	8ft	043156002993	\$193.00	
SD10-8.0 630 TMNT N N SL, Stainless Steel Top Mount	630	8ft	043156003006	\$383.00	
SD10-8.0 716 TMNT N N SL, Aged Bronze Top Mount	716	8ft	043156003020	\$287.00	

Schlage Residential Sliding Door Hardware (continued)



**Track Adapter**

Description	Finish	SKU	Price	Special Order
SD10 619 ADPTR N N SL, Satin Nickel Track Adapter	619	043156003051	\$15.50	
SD10 622 ADPTR N N SL, Black Track Adapter	622	043156003068	13.40	
SD10 630 ADPTR N N SL, Stainless Steel Track Adapter	630	043156003075	16.30	
SD10 716 ADPTR N N SL, Aged Bronze Track Adapter	716	043156003099	15.50	

### Overhead Stops and Holders

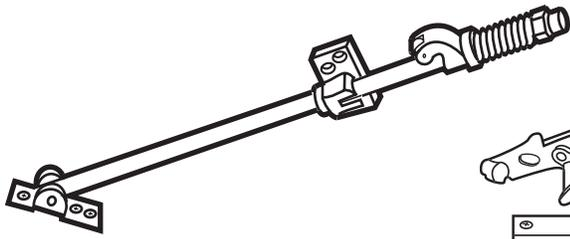

70 Series

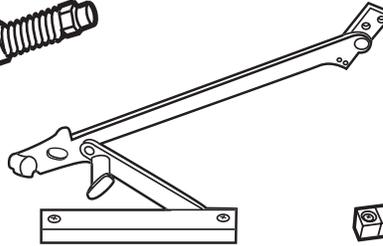

81 Series

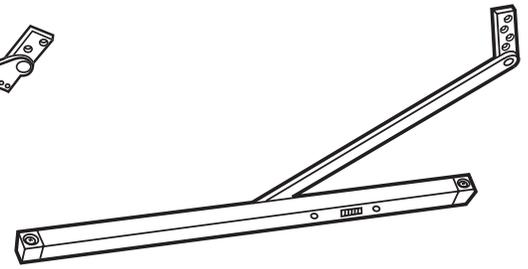

90 Series

#### 70 Series

70 Series	Description	Function	Finish	Price Each
704H	70 Series Stop and Holder, Size 4	Hold-Open	US26D	\$302.00
704S	70 Series Stop, Size 4	Stop-Only	US26D	302.00

#### 81 Series

81 Series	Description	Function	Finish	Price Each
814H	81 Series Stop and Holder, Size 4	Hold-Open	US32D	\$421.00
814S	81 Series Stop, Size 4	Stop-Only	US32D	368.00

#### 90 Series

90 Series	Description	Function	Finish	Price Each
903H	90 Series Stop and Holder, Size 3	Hold Open	US32D	\$414.00
904H	90 Series Stop and Holder, Size 4	Hold Open	US32D	414.00
905H	90 Series Stop and Holder, Size 5	Hold Open	US32D	414.00
906H	90 Series Stop and Holder, Size 6	Hold Open	US32D	414.00
903S	90 Series Stop, Size 3	Stop Only	US32D	414.00
904S	90 Series Stop, Size 4	Stop Only	US32D	414.00
905S	90 Series Stop, Size 5	Stop Only	US32D	414.00
906S	90 Series Stop, Size 6	Stop Only	US32D	414.00
AJK90	Angle Jamb Bracket Kit	-	US26D	70.00

Overhead Stops and Holders (continued)

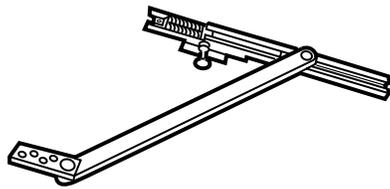

100 Series

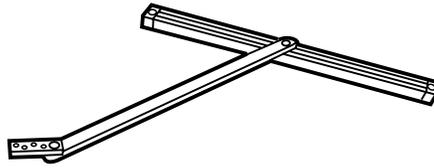

410 Series

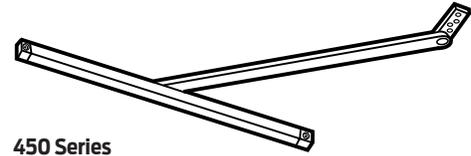

450 Series

100 Series

100 Series	Description	Function	Finish	Price Each
104H	100 Series Stop and Holder, Size 4	Hold Open	US32D	\$403.00
105H	100 Series Stop and Holder, Size 5	Hold Open	US32D	403.00
102S	100 Series Stop, Size 2	Stop Only	US32D	403.00
103S	100 Series Stop, Size 3	Stop Only	US32D	403.00
104S	100 Series Stop, Size 4	Stop Only	US32D	403.00
104S	100 Series Stop, Size 4	Stop Only	US10B	424.00
104S ADJ	100 Series Stop, Size 4 w/ ADJ	Stop Only	US32D	484.00
105S	100 Series Stop, Size 5	Stop Only	US32D	403.00
106S	100 Series Stop, Size 6	Stop Only	US32D	403.00

410 Series

410 Series	Description	Function	Finish	Price Each
414H	410 Series Stop and Holder, Size 4	Hold Open	US32D	\$149.00
413S	410 Series Stop, Size 3	Stop Only	US32D	149.00
414S	410 Series Stop, Size 4	Stop Only	US32D	149.00
414S	410 Series Stop, Size 4	Stop Only	652	125.00

450 Series

450 Series	Description	Function	Finish	Price Each
454H	450 Series Stop and Holder, Size 4	Hold Open	US32D	\$184.00
454H	450 Series Stop and Holder, Size 4	Hold Open	652	142.00
451S	450 Series Stop, Size 1	Stop Only	US32D	184.00
451S	450 Series Stop, Size 1	Stop Only	652	142.00
452S	450 Series Stop, Size 2	Stop Only	US32D	184.00
452S	450 Series Stop, Size 2	Stop Only	652	142.00
453S	450 Series Stop, Size 3	Stop Only	US32D	184.00
453S	450 Series Stop, Size 3	Stop Only	652	142.00
454S	450 Series Stop, Size 4	Stop Only	US32D	184.00
454S	450 Series Stop, Size 4	Stop Only	652	142.00
454S	450 Series Stop, Size 4	Stop Only	US10B	203.00
454S	450 Series Stop, Size 4	Stop Only	SP28	121.00
455S	450 Series Stop, Size 5	Stop Only	US32D	184.00
455S	450 Series Stop, Size 5	Stop Only	652	142.00

**Overhead Stops and Holders (continued)**

**The 510 Series and the 550 Series are no longer available for sale.  
Please, contact your local representative for further details.**

### Schlage Residential: How to Order

Thank you for your order and continuing business. In order to expedite order processing, please include the following information on purchase orders:

- Schlage account number
- Product UPC numbers (if available)
- Quote number (if applicable)
- Specific keying requirements

Note: Line quantities of keyed products must be divisible by KA quantities.  
Example: 20 locks ordered KA4 results in 5 groups of 4 locks keyed alike,  
however, 20 locks ordered KA3 is not divisible and results in order  
processing delays as Schlage seeks clarification

#### · Door handing

##### **How to identify door handing:**

Handing of all doors is determined from the exterior of the room's entrance.

- If the hinge is on the left side of the door, the door is "left hand" (LH)
- If the hinge is on the right side of the door, the door is "right hand" (RH)
- To order a handed product, please specify LH or RH
- To order a handleset, handing is still determined from the exterior of the door
- We will use that information to determine the handing for the inside of the door

**Lever Handing Diagram**

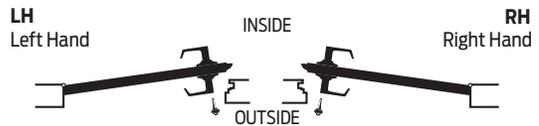

## Schlage Commercial: How To Order

To order Schlage products, descriptive data should be in the same sequence as shown:

LINE ITEM	QTY	PRODUCT	OUTSIDE		INSIDE		HAND	LATCH	DR STRIKE	THK	EXT	DIM	ADDITIONAL DETAILS
			DES	FIN	DES	FIN							
1	2	3	4	5	6	7	8	9	10	11	12	13	14

- LINE ITEM:** Line item number
- QTY:** Quantity
- PRODUCT:** Complete lock product or part number
- OUTSIDE DES:** Outside design code
- OUTSIDE FIN:** Outside finish code
- INSIDE DES:** Inside design code. Leave blank if same as outside design code.
- INSIDE FIN:** Inside finish code. Leave blank if same as outside finish code.
- HAND:** Hand of door. Only one hand allowed per line item.  
Example: RH=Right Hand, LH=Left Hand, RR=Right Reverse, LR=Left Reverse.

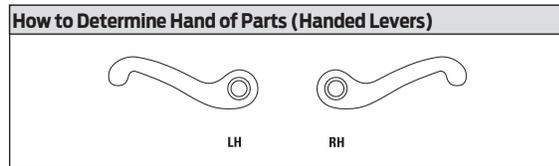
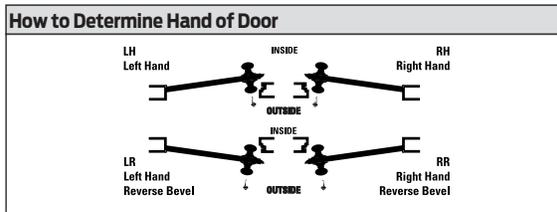

- LATCH:** Latch. Leave blank for standard or specify part number if non-standard latch is required. LLL=Less Latch.
- STRIKE:** Strike. Leave blank for standard or specify part number if non-standard strike is required. LLL=Less Strike.
- DR THK:** Door Thickness. Enter door thickness if non-standard. Example: 138=1 3/8", 214=2 1/4", 212=2 1/2".
- EXT:** Extension. Enter one of the following when doors 2" thick or greater are specified:  
EE = Extended Equally  
EI = Extended Inside  
EO = Extended Outside  
ED = Extended Differently

EI or EO assumes the latch will be centered on a 1 3/4" door, to which material has been added.

- DIM:** Enter dimension for non-standard strike lip length and mortise cylinder or blocking ring length.  
012 = 1/8"            118 = 1 1/8"  
018 = 3/16"        114 = 1 1/4"  
025 = 1/4"           138 = 1 3/8"  
031 = 5/16"        112 = 1 1/2"  
037 = 3/8"           158 = 1 5/8"  
050 = 1/2"           134 = 1 3/4"  
078 = 7/8"           200 = 2"  
100 = 1"             400 = 4"

- ADDITIONAL DETAILS:** Enter detail for keying information and for special requirements.

## LE - How to Order

Common Pricing Information	
1.	Locks are furnished with standard features unless otherwise specified.
2.	Door thickness is 1 3/4"
3.	Split finishes and designs will be priced at the highest list price of the design and/or finish.
4.	Engineering specials are denoted by a part number beginning with "X" and are not subject to standard discounting.
5.	 denotes a lock or part that requires an extended lead time.
6.	 denotes a handed product and requires handing to be specified.
7.	For all restricted keyways (Everest B, D, 29R, and 29T, also, Quad, Numbered, and Reversed) add \$16.00. This does not apply to Primus cylinders. See Terms and Conditions for ordering information and requirements.
8.	Locks, keys and cylinders containing restricted keyways require additional documentation to order. Please see Terms and Conditions for the specific requirements.
9.	Keyway must be specified for keyed functions and cylinders. If not specified, default keyway will be S123 for KA (keyed alike), KD (keyed different) and 0-bitted product and S145 for factory managed masterkey systems.
10.	Multiple keying options are available. Locks and cylinders are furnished KD unless otherwise specified or excepted by notation.
11.	Control Keys for permanent and construction cores are not included with the lock or cylinder and must be ordered separately.
12.	Locks specified with "C" keyway and KD or 0-bitted will receive 6-pin cylinders (keyed 5) with 5-pin keys.
13.	Full Size Interchangeable Cores (FSIC) are furnished 1-bitted unless otherwise specified. If 0-bitted is selected, the order will be entered as 1-bitted. This does not apply to FSIC Primus® cores.
14.	Conventional cylinders, Primus cylinders (conventional and FSIC) can be supplied 0-bitted. If 1-bitted is selected, the order will be entered as 0-bitted.
15.	Available plug face finishes are 622, 626, and 643e. For chrome, nickel or stainless steel finish colors, the plug face finish is 626.

LE - How to Order

	REQUIRED FIELDS	FACTORY DEFAULT AND OPTIONS
	LE - BMS - GRW - P - 03 - 626 - 00A - - - 612 - - - LH - 10-136 - 134 - S123 - -	
<b>1. Series:</b>		
<b>2. Chassis/Function:</b>		
BMS Mobile enabled mortise with LED Indicator		
BMB Mobile enabled mortise with push button and LED		
BMD Mobile enabled mortise deadbolt with LED		
MS Mortise with LED indicator		
MB Mortise with push button and LED		
MD Mortise Deadbolt with LED		
<b>3. Style:</b>		
GRW Greenwich sectional with rose		
ADD Addison escutcheon		
<b>4. Cylinder Type:</b>		
P Mortise cylinder, Schlage 6-pin		
For all options see LE ordering pages		
<b>5. Outside Lever:*</b>		
06 Suites with Rhodes		
07 Suites with Athens		
17 Suites with Sparta		
BRW Broadway		
BRK Boardwalk		
LAT Latitude		
LON Longitude		
For all options see SES Price Book		
*To add tactile warning, use prefix 8. Example: 806		
<b>6. Outside Finish:</b>		
626 Satin Chrome		
619 Satin Nickel		
622 Matte Black		
625 Bright Chrome		
643e Aged Bronze		
<b>7. Outside Rose:</b> Specify only for Greenwich Trim		
00A 2 1/8" (54 mm) diameter (Standard)		
00B 2 9/16" (65 mm) diameter		
00C 2 5/8" (66 mm) diameter with bevel		
<b>8. Inside Lever:</b> Specify only if different from outside lever		
3 Suites with Tubular style		
LAT Latitude		
For all options see LE ordering pages		
<b>9. Inside Finish:</b> Specify only if different from outside finish		
See options under 6 above		
<b>10. Inside Rose:</b> Specify only for Greenwich Trim and only if different from Outside Rose		
See options under 7 above		
<b>11. Handing:</b>		
RH Right Handed (Standard)		
LH Left Handed		
RHR Right Handed Reverse		
LHR Left Handed Reverse		
<b>12. Strike Plate Lip Length:</b>		
10-136 1 3/16" lip length (Standard for MS/MB)		
10-136-112 1 1/2" lip length		
For all options see LE ordering pages		
<b>13. Door Thickness</b>		
<b>134 1 3/4" (Standard)</b>		
Options available up to 2-1/4" thickness - see LE ordering pages		
<b>14. Keyway Type</b>		
S123 Everest 29 S (Standard)		
For all options see LE ordering pages		
<b>15. Additional Options</b>		

## Multi-family How to Order -Electrified Locks

### NDE - How to Order

#### Standard Features

Certification	ANSI/BHMA Certified A156.25-2013, A156.2-2011, Series 4000, Grade 1, UL 294, UL 10C
Latch	1 1/8" x 2 1/4", Square corner faceplate, 1" housing diameter, 1/2" throw
Strike	1 1/4" x 4 7/8", ANSI Square corner, with DPS magnets, no box
Backset	2 3/4"
Cylinder	6-Pin solid brass, keyed 6-pin, S123 keyway, keyed different (KD)
Door Range	Comes set for 1 3/4" thick doors. Can be field adjusted for doors 1 5/8"-2" thick.
Keys	Two nickel silver cut keys per lock, 6-pin, S123 section



#### Common Pricing Information

1.	Locks are furnished with standard features unless otherwise specified.
2.	Door thickness is 1 3/4"
3.	Split finishes and designs will be priced at the highest list price of the design and/or finish.
4.	Engineering specials are denoted by a part number beginning with "X" and are not subject to standard discounting.
5.	⌚ denotes a lock or part that requires an extended lead time.
6.	For all restricted keyways (Everest D, Everest 29 T, Quad, Numbered, Reversed) add \$16.00. This does not apply to Primus cylinders. See Terms and Conditions for ordering information and requirements.
7.	Locks, keys and cylinders containing restricted keyways require additional documentation to order. Please see Terms and Conditions for the specific requirements.
8.	Keyway must be specified for keyed functions and cylinders. If not specified, default keyway will be S123 for KA, KD and 0-bitted product and S145 for Factory managed masterkey systems.
9.	Multiple keying options are available. Locks and cylinders are furnished KD unless otherwise specified or excepted by notation.
10.	Control Keys for permanent and construction cores are not included with the lock or cylinder and must be ordered separately.
11.	Locks specified with "C" keyway and KD or 0-bitted will receive 6 pin cylinders (keyed 5) with 5 pin keys.
12.	Full Size Interchangeable Cores (FSIC) are furnished 1-bitted unless otherwise specified. If 0-bitted is selected, the order will be entered as 1-bitted. This does not apply to FSIC Primus® cores.
13.	Conventional cylinders, Primus cylinders (conventional and FSIC) can be supplied 0-bitted. If 1-bitted is selected, the order will be entered as 0-bitted.
14.	Available plug face finishes are 622, 626, and 643e. For chrome, nickel or stainless steel finish colors, the plug face finish is 626.

**NDE - How to Order**

	REQUIRED FIELDS				FACTORY DEFAULT AND OPTIONS					
	NDE	80	PD	ATH	626	SPA	13-047	10-130	138	S123
<b>1. Series:</b>										
<b>2. Function:</b> 80 Storeroom with Vandlgard										
<b>3. Cylinder Type:</b> PD Schlage 6-pin Full Cylinder For options see NDE ordering pages										
<b>4. Outside Lever:*</b> LLL Less interior and exterior levers SPA Sparta RHO Rhodes ATH Athens LAT Latitude LON Longitude BRW Broadway BRK Boardwalk *To add tactile warning, use prefix 8. Example: 8SPA										
<b>5. Outside Finish:</b> 626 Satin Chrome 619 Satin Nickel 622 Matte Black 625 Bright Chrome 643e Aged Bronze										
<b>6. Inside Lever:*</b> Specify only if different from outside lever SPA Sparta RHO Rhodes ATH Athens LAT Latitude LON Longitude BRW Broadway BRK Boardwalk *To add tactile warning, use prefix 8. Example: 8SPA										
<b>7. Inside Finish:</b> Specify only if different from outside finish 626 Satin Chrome 619 Satin Nickel 625 Bright Chrome 643e Aged Bronze										
<b>8. Backset and Latchbolt:</b> 13-047 2 3/4" Backset, Deadlatch, Square Corner, 1 1/8" x 2 1/4" (Standard) For options see individual Class/Chassis page										
<b>9. Strike Plate:</b> 10-130 1 3/16" Lip, ANSI, DPS magnets, no box, 1 1/4" x 4 7/8" (Standard) For options see individual Class/Chassis page										
<b>10. Strike Lip Dimension:</b> Specify only if different from options 10-130 or 10-132 dimensions 138 1 3/8" lip length option available on 10-130 and 10-131 strike plates (normally 1 3/16") 112 1 1/2" lip length option available on 10-132 strike plate (normally 1 1/8")										
<b>11. Keyway Type:</b> S123 Everest 29 S (Standard) For options see individual Class/Chassis page										
<b>12. Additional Options</b>										

**CTE - How to Order**

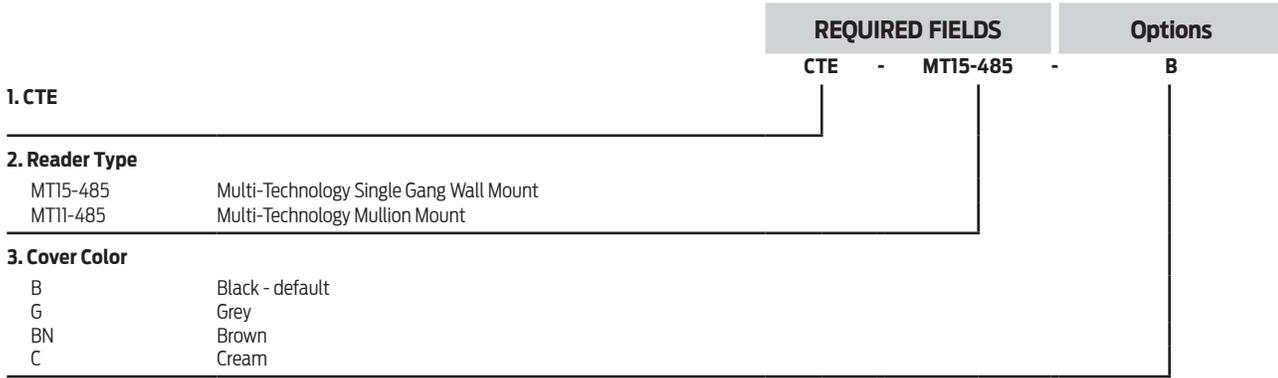

**1-2. Select CTE Kit Reader Option**

- CTE-MT11-485 ..... CTE with Multi-Technology Mullion Reader Kit
- CTE-MT15-485..... CTE with Multi-Technology Single Reader Kit

**3. Select Color**

- B ..... Black – Default
- G ..... Grey
- BN ..... Brown
- C ..... Cream

**ND Series**

## Ordering Procedures

**Standard Features**

Certification	ANSI/BHMA Certified A156.2-2011, Series 4000, Grade 1, UL Listed for 3-hour fire door.
Latch	1 1/8" x 2 1/4", Square corner faceplate, 1" housing diameter, 1/2" throw
Strike	1 1/4" x 4 7/8", ANSI Square corner, no box
Backset	2 3/4"
Cylinder	6-Pin solid brass, keyed 6-pin, S123 keyway, keyed different (KD)
Door Range	1 5/8" – 2 1/8" for all functions except ND85; 1 3/4" – 2" for ND85
Keys	Two nickel silver cut keys per lock, 6-pin, S123 section



To order Schlage products, descriptive data should be in the same sequence as shown below.

Line Item	Qty	Product	Outside		Inside		Hand	Latch	Strike	Dr Thk	Ext	DIM	Additional Details
			DES	FIN	DES	FIN							
1	10	ND53PD	RHO	622	OME	–	–	13-247	10-025	214	EE	138	KA

**Line Item:** Line item number

**Qty:** Quantity

**Product:** Product function + Cylinder code

**Outside Des:** Outside lever design

**Outside Fin:** Outside finish

**Inside Des:** Inside lever design: Specify only if different from the outside lever design

**Inside Fin:** Inside lever finish: Specify only if different from the outside finish

**Hand:** Hand of door: N/A for ND lock

**Latch:** Product latch: Leave blank for standard latch or specify part number if non-standard latch is required.

**Strike:** Product strike: Leave blank for standard strike or specify part number if non-standard strike is required.

**Dr Thk:** Door thickness: Enter door thickness if non-standard. Example: 138=1 3/8", 214=2 1/4"

**Ext:** Extension: Enter for doors 2 1/8" or greater. Example: EE=extended equally, EI=extended inside, EO=extended outside, ED=extended differently

**Dim:** Dimension: Enter only for non-standard strike lip length

**Additional Details:** Enter additional detail for keying information or special requirements

**Common Pricing Information**

- Locks are furnished with standard features unless otherwise specified.
- Door thickness is 1 3/4" unless otherwise specified.
- Split finishes and designs will be priced at the highest list price of the design and/or finish.
- ⌚ denotes a lock or part that requires an extended lead time.
- 👤 denotes a handed product and requires handing to be specified.
- For all restricted keyways (Everest D, Everest 29 T, Quad, Numbered, Reversed) add \$22.00. This does not apply to Primus cylinders. See Terms and Conditions for ordering information and requirements.
- Locks, keys and cylinders containing restricted keyways require additional documentation to order. Please see Terms and Conditions for the specific requirements.
- Keyway must be specified for keyed functions and cylinders. If not specified, default keyway will be S123 for KA, KD and 0-bitted product and S145 for Factory managed masterkey systems.
- Multiple keying options are available. Locks and cylinders are furnished KD unless otherwise specified or excepted by notation.
- Control Keys for permanent and construction cores are not included with the lock or cylinder and must be ordered separately.
- Locks specified with "C" keyway and KD or 0-bitted will receive 6 pin cylinders.
- Full Size Interchangeable Cores (FSIC) are furnished 1-bitted unless otherwise specified. If 0-bitted is selected, the order will be entered as 1-bitted. This does not apply to FSIC Primus® cores.
- Conventional cylinders, Primus cylinders (conventional and FSIC) can be supplied 0-bitted. If 1-bitted is selected, the order will be entered as 0-bitted.
- Available plug face finishes are 606, 622, 626, 643e.
- Locks and cylinders will be furnished with 2 keys each as standard. Additional keys will be charge at the additional cut keys charge appropriate for the cylinder/key type

# Multi-family How to Order - Locks

## L Series

### Ordering Procedures

#### Standard Features

Certifications	L/LV9000: ANSI/BHMA Certified A156.13-2012, Series 1000, Grade 1 Operational, Grade 1 Security, UL Listed for 3-hour fire door (except L9076 and L9077). With FSIC Interchangeable Core Cylinders: Grade 2 Security. With FSIC Interchangeable Core Cylinders: Grade 3 Security. L400: ANSI/BHMA Certified A156.36-2010, Grade 1, UL Listed for 3-hour fire door.
Case Size	L/LV9000: 4 7/16" x 6 1/16" x 1"; L400: 4 7/16" x 3 5/8" x 1"
Armor Front	L/LV9000: 1 1/4" x 8"; L400: 1 1/4" x 5 9/16"
Deadbolt	1" Throw stainless steel
Latchbolt	3/4" Throw stainless steel with anti-friction tongue
Strike	L/LV9000: 1 1/4" x 4 7/8" Square corner, 1-3/16" lip, box; L400: 1 1/8" x 3 5/8" square corner, box
Backset	2 3/4"
Cylinder	6-Pin solid brass, keyed 6-pin, S123 keyway, keyed different (KD)
Door Range	1 3/4"
Keys	Two nickel silver cut keys per lock, 6-pin, S123 section



To order Schlage products, descriptive data should be in the same sequence as shown below.

Line Item	Qty	Product	Outside		Inside		Hand	Latch	Strike	Dr Thk	Ext	DIM	Additional Details
			DES	FIN	DES	FIN							
1	10	L9050P	12A	626	06B	613	RH	09-669	10-072	2	EE	134	KA

**Line Item:** Line item number

**Qty:** Quantity

**Product:** Product function + cylinder code

**Outside Des:** Outside lever design + rose/escutcheon code

**Outside Fin:** Outside finish

**Inside Des:** Inside lever design + rose/escutcheon code, specify only if different from the outside lever design

**Inside Fin:** Inside lever finish, specify only if different from the outside finish

**Hand:** Hand of door, specify only for handed lever designs or for LM9300 MultiPoint lock

**Latch:** Product armor front, leave blank for standard armor or specify part number if non-standard armor is required.  
LLL = less armor front

**Strike:** Product strike, leave blank for standard strike or specify part number if non-standard strike is required. LLL = less strike

**Dr Thk:** Door thickness, leave blank for standard thickness (1 3/4") or specify if non-standard. Example: 138 = 1 3/8", 214 = 2 1/4"

**Ext:** Extension, enter one of the following when door thicknesses 2" or greater are specified: EE = Extended Equally, EI = Extended Inside, EO = Extended Outside

**Dim:** Dimension; for locks enter only for non-standard strike lip length, for parts enter for non-standard strike lip length, mortise cylinder or blocking ring length

**Additional Details:** Enter additional detail for keying information or special requirements

#### Common Pricing Information

- Locks are furnished with standard features unless otherwise specified.
- Door thickness is 1 3/4" unless otherwise specified.
- Split finishes and designs will be priced at the highest list price of the design and/or finish.
- ⌚ denotes a lock or part that requires an extended lead time.
- 👤 denotes a handed product and requires handing to be specified.
- For all restricted keyways (Everest D, Everest 29 T, Quad, Numbered, Reversed) add \$22.00. This does not apply to Primus cylinders. See Terms and Conditions for ordering information and requirements.
- Locks, keys and cylinders containing restricted keyways require additional documentation to order. Please see Terms and Conditions for the specific requirements.
- Keyway must be specified for keyed functions and cylinders. If not specified, default keyway will be S123 for KA, KD and O-bitted product and S145 for Factory managed masterkey systems.
- Multiple keying options are available. Locks and cylinders are furnished KD unless otherwise specified or excepted by notation.
- Control Keys for permanent and construction cores are not included with the lock or cylinder and must be ordered separately.
- Locks specified with "C" keyway and KD or O-bitted will receive 6 pin cylinders.
- Full Size Interchangeable Cores (FSIC) are furnished 1-bitted unless otherwise specified. If O-bitted is selected, the order will be entered as 1-bitted. This does not apply to FSIC Primus® cores.
- Conventional cylinders, Primus cylinders (conventional and FSIC) can be supplied O-bitted. If 1-bitted is selected, the order will be entered as O-bitted.
- Available plug face finishes are 606 and 626. For brass or bronze finish colors, the plug face finish is 606. For chrome, nickel or stainless steel finish colors, the plug face finish is 626.
- Locks and cylinders will be furnished with 2 keys each as standard. Additional keys will be charge at the additional cut keys charge appropriate for the cylinder/key type

**ALX Series**  
Ordering Procedures

Standard Features	
Certification	ANSI/BHMA Certified A156.2-2011, Series 4000, Grade 2, UL Listed for 3-hour fire door.
Latch	1 1/8" x 2 1/4", Square corner faceplate, 1" housing diameter, 1/2" throw
Strike	1 1/4" x 4 7/8", ANSI, Square corner, no box
Backset	2 3/4"
Cylinder	6-Pin solid brass, keyed 6-pin, S123 keyway, keyed different (KD)
Door Range	1 3/8" – 1 7/8"
Keys	Two nickel silver cut keys per lock, 6-pin, S123 section

 Indicates products that have EPD documentation available and meet LEED v4.

**BHMA**  
CERTIFIED

To order Schlage products, descriptive data should be in the same sequence as shown below.

Line Item	Qty	Product	Outside		Inside		Hand	Latch	Strike	Dr Thk	Ext	DIM	Additional Details
			DES	FIN	DES	FIN							
1	10	ALX53PD	SAT	626	NEP	619	-	11-096	10-025	200	EE	-	-

- Line Item:** Line item number
- Qty:** Quantity
- Product:** Product function + Cylinder code
- Outside Des:** Outside lever design
- Outside Fin:** Outside finish
- Inside Des:** Inside lever design: Specify only if different from the outside lever design
- Inside Fin:** Inside lever finish: Specify only if different from the outside finish
- Hand:** Hand of door: N/A for ALX lock
- Latch:** Product latch: Leave blank for standard latch or specify part number if non-standard latch is required.
- Strike:** Product strike: Leave blank for standard strike or specify part number if non-standard strike is required.
- Dr Thk:** 1-3/8" through 1-3/4"
- Dim:** Dimension: Enter only for non-standard strike lip length
- Additional Details:** Enter additional detail for keying information or special requirements

**Common Pricing Information**

1. Locks are furnished with standard features unless otherwise specified.
2. Door thickness is 1 3/4" unless otherwise specified.
3. Split finishes and designs will be priced at the highest list price of the design and/or finish.
4. ⌚ denotes a lock or part that requires an extended lead time.
5. 🖐️ denotes a handed product and requires handing to be specified.
6. For all restricted keyways (Everest D, Everest 29 T, Quad, Numbered, Reversed) add \$22.00. This does not apply to Primus cylinders. See Terms and Conditions for ordering information and requirements.
7. Locks, keys and cylinders containing restricted keyways require additional documentation to order. Please see Terms and Conditions for the specific requirements.
8. Keyway must be specified for keyed functions and cylinders. If not specified, default keyway will be S123 for KA, KD and 0-bitted product and S145 for Factory managed masterkey systems.
9. Multiple keying options are available. Locks and cylinders are furnished KD unless otherwise specified or excepted by notation.
10. Control Keys for permanent and construction cores are not included with the lock or cylinder and must be ordered separately.
11. Locks specified with "C" keyway and KD or 0-bitted will receive 6 pin cylinders.
12. Full Size Interchangeable Cores (FSIC) are furnished 1-bitted unless otherwise specified. If 0-bitted is selected, the order will be entered as 1-bitted. This does not apply to FSIC Primus® cores.
13. Conventional cylinders, Primus cylinders (conventional and FSIC) can be supplied 0-bitted. If 1-bitted is selected, the order will be entered as 0-bitted.
14. Available plug face finishes are 606, 622, 626, 643e.
15. Locks and cylinders will be furnished with 2 keys each as standard. Additional keys will be charge at the additional cut keys charge appropriate for the cylinder/key type

# Multi-family How to Order - Exits

## Von Duprin: How to Order

### Sequence Example

		EL	98	27	L	F	-	US26D	3'	RHR	LBR	US26D	996/ US26D	299F/ 06	SNB	HM
<b>Prefixes</b>																
None	Standard															
AX	Accessible Device	RX	Request to Exit													
CD	Cylinder Dogging - Panic Only	RX2	Double Request to Exit													
CX	Chexit	SD	Special Dogging - Panic Only													
E	Electric Locking Mortise/Lever	SS	Signal Switch													
EL	Electric Latch Retraction	WS	Windstorm (FEMA rated)													
HH	Hurricane Device	Surface Vertical Rod Exit Device														
LX	Latch Bolt Monitoring	Heavy Protection - Rim														
PL	Pullman Latch															
PN	Pneumatic Latch Retraction	XP														
QEL	Quiet Electric Latch Retraction															
<b>Device Series</b>																
22	Push Bar Device	88	Cross Bar Device													
33A/35A	Push Bar Device	94/95	Recessed Device													
55	Cross Bar Device	98/99	Push Bar Device													
<b>Device Type</b>																
None	Rim Device															
27	Surface Mounted Vertical Rod Device															
47	Concealed Vertical Rod Device															
47WDC	Concealed Vertical Rod Wood Door Device															
48	Concealed Vertical Rod Device															
49	Concealed Vertical Cable Device (see CVC how to order form)															
50WDC	Concealed Vertical Cable Wood Door Device															
57	Three-Point Latch Device															
75	Mortise Lock Device															
<b>Trim Functions</b>																
XX	AD Trim (to come from client)	L-NL	Lever, Rigid - Night Latch													
DT	Dummy Trim	NL	Night Latch													
EO	Exit Only	NL-OP	Night Latch Cylinder Assembly, Optional Pull													
HL	Hospital Pull Trim	TL	Turn Lever													
K	Knob	TL-BE	Turn Lever - Blank Escutcheon													
K-BE	Knob - Blank Escutcheon	TP	Thumbpiece													
K-DT	Knob, Rigid - Dummy Trim	TP-BE	Thumbpiece - Blank Escutcheon													
K-NL	Knob, Rigid - Night Latch															
L	Lever (Classroom)															
L-BE	Lever - Blank Escutcheon															
L-DT	Lever, Rigid - Dummy Trim															
<b>Rating</b>																
F	Fire Exit hardware	Blank	Panic Exit Hardware													
<b>Suffix</b>																
-2	Double Cylinder	-2SI	Double Cylinder with Security Indicator													
<b>Finish</b>																
US3, US4, US10, US15, US26, US26D, US26D-AM, US28, US32D, US32D-AM, 313, 315																
<b>Door Width</b>																
3'	Standard Default	<b>Door Thickness</b>														
4'		1 3/4"	Standard													
2'		2 1/4"	Optional													
<b>Handing</b>																
RHR	Right Hand Reverse	LHR	Left Hand Reverse													
<b>Less Bottom Rod/Cable</b>																
LBR	Less Bottom Rod	LBR-AFL	LBR with Fire Pin													
LBL	Less Bottom Cable	LBL-AFL	LBL with Fire Pin													
<b>Trim Options/Finish</b>																
See trim options/finish for each series																
<b>Trim Options/Finish</b>																
See trim options for each series																
<b>Lever Style</b>																
06	Standard Default															
Optional Levers available																
<b>Accessories</b>																
CYL	Cylinder	SEC	Security Screws													
GBK	Glass Bead Kit	SLM	SLM Blocking													
SNB	Sex Bolts															
<b>Other Information</b>																
<b>Touchbar Options</b>		BRAILLE (Vision impaired touchpad, Raised letter, and Braille), PUSH (Touchbar trim embossed "PUSH") RSS (Red silk-screened lettered touchbar trim), KN (Knurled Touchbar), SG (Safety Glow)														
<b>Miscellaneous</b>		CE (CE Labeled), LCP (Less Cover Plate), 10WDA (#10WDA Cover Plate), RAT REL (Ratchet Release Assy), WH (Weep Holes)														
<b>Door Material</b>		AL (Aluminum Door), HM (Hollow Metal), WD (Wood Door), CP (Composite Door) INS2 (Insulclad - 1/2"), INS4 (Insulclad - 1/4"), SC (Steelcraft, HH Device Only)														
<b>Door Application</b>		D (Double Egress), P (Pair of Doors), S (Single Door)														

Note: Not all options are listed. Not all options are available on all series. See the specific series pages for complete options available. Please contact customer care for questions.

## Falcon: Exit Device - How to Order

### How to Order Sequence Example

**EL F 25 V L-DANE US3 3' LHR LBR SNB WD**

#### Prefixes

<b>AX</b>	Accessible Device (25 and 19 Series Only)
<b>CD</b>	Cylinder Dogging
<b>LD</b>	Less Dogging
<b>RX</b>	Touchbar Request to Exit
<b>DM</b>	Latchbolt Monitor Switch - when fully extended
<b>LM</b>	Latchbolt Monitor Switch - when fully retracted
<b>KOR</b>	Key Bypass Switch
<b>EL</b>	Electric Latch Retraction
<b>FSA</b>	Electric Lock or Unlock Trim-Fail Safe (25 Series Only)
<b>FSE</b>	Electric Lock or Unlock Trim-Fail Secure (25 Series Only)
<b>EA</b>	Exit Alarm

#### Rating

<b>F</b>	Fire Exit Hardware
<b>Blank</b>	Panic Exit Hardware

#### Device Series

<b>19</b>	Touch Bar Device, Narrow Stile
<b>24</b>	Touch Bar Device, Narrow Stile
<b>25</b>	Touch Bar Device
<b>XX</b>	Crossbar Device

#### Device Type

<b>R</b>	Rim	<b>C</b>	Concealed Vertical rod
<b>V</b>	Surface Vertical Rod	<b>C-WDC</b>	Concealed Vertical rod Wood Door
<b>M</b>	Mortise		

#### Trim Function (see Trim pages for all functions)

<b>EO</b>	Exit Only	<b>K</b>	Knob
<b>DT</b>	Dummy Trim	<b>L</b>	Lever (Dane Standard)
<b>NL</b>	Night Latch	<b>TL</b>	Thumb Lever
<b>C</b>	Cylinder Trim Plate	<b>NL-OP</b>	Night Latch Pull by other
<b>TP</b>	Thumbpiece	<b>KIL</b>	Key in Lever

#### Latch Option

<b>DL</b>	Dead Locking
-----------	--------------

#### Finish

<b>US3</b>	<b>US10</b>	<b>US15*</b>	<b>US26</b>	<b>US32</b>	<b>SP28</b>	
<b>US4</b>	<b>US11*</b>	<b>US19*</b>	<b>US26D</b>	<b>US32D</b>	<b>SP313</b>	<b>313AN</b>

#### Door Width

<b>3'</b>	Standard Default
<b>4'</b>	
<b>2'</b>	

#### Door Thickness

<b>1 3/4"</b>	Standard
<b>2 1/4"</b>	Optional

#### Handing

<b>RHR</b>	Right Hand Reverse
<b>LHR</b>	Left Hand Reverse

#### Less Bottom Rod

<b>LBR</b>	Less Bottom Rod
<b>LBR-AFL</b>	LBR w/Auxiliary Fire Pin

#### Accessories

<b>CYL</b>	Cylinder	<b>SNB</b>	Sex Bolts	<b>AMS</b>	All Machine Screws
<b>SK</b>	Shim Kit	<b>SLM</b>	SLM Blocking		

#### Other Miscellaneous Door Information

<b>HMD</b>	Hollow Metal Door	<b>SCDC</b>	Steel Channel Door Construction	-	Door Label (20 min, 45 min, 90 min 1-1/2 hr)
<b>HMF</b>	Hollow Metal Frame	-	Specify other Door or Frame	-	Stile Width
<b>WD</b>	Wood Door	-	Material information	-	Frame Stop Height
<b>WDF</b>	Wood Frame	-	Door Height	<b>SGL</b>	Single Door
<b>ALD</b>	Aluminum Door	-	Door Thickness	<b>PR</b>	Pair of Doors Swinging Same Direction
<b>ALF</b>	Aluminum Frame	-	Door Undercut	<b>DE</b>	Double Egress Doors
<b>CPD</b>	Composite Door	-		<b>CON</b>	Allegion Connect

# Multi-family How to Order - Exits

## Falcon: Trim - How to Order

### How to Order Sequence Example

			510	L - R	US26D	LHR	SUTRO	FSE	CYL
<b>Trim Series</b>									
<b>D24 Series</b>	<b>D25 Series</b>	<b>19 Series</b>							
711	510	911							
712	511	912							
715	512	914							
717	513	917							
718	717	918							
	718	920							
		930							
<b>Trim Function</b> (see Trim pages for all functions)									
EO	Exit Only								
DT	Dummy Trim								
NL	Night Latch								
C	Cylinder Trim Less Pull								
TP	Thumbpiece								
K	Knob								
L	Lever (Dane Standard)								
KIL	Key in Lever								
TL	Thumb Lever								
<b>Device Type</b>									
R	Rim								
V	Surface Vertical Rod								
M	Mortise								
C	Concealed Vertical Rod (includes WDC)								
<b>Finish</b>									
US3	US10	US11*	US19*	US26D	SP313				
US4	US10B	US15*	US26	SP28	US32	US32D			
<b>Handing</b>									
RHR	Right Hand Reverse								
LHR	Left Hand Reverse								
<b>Lever Style</b>									
<b>DANE</b>	(DAN)	supplied standard if not specified	<b>BROADWAY</b>	(BRW)*	(available on 24 and 25 Series only)				
<b>SUTRO</b>	(SUT)		<b>DANISH</b>	(DSH)*	(available on 24 and 25 Series only)				
<b>QUANTUM</b>	(QUA)		<b>LATITUDE</b>	(LAT)*	(available on 24 and 25 Series only)				
<b>AVALON</b>	(AVA)	(available on 24, 25 and xx Series only)	<b>LONGITUDE</b>	(LON)*	(available on 24 and 25 Series only)				
<b>BOARDWALK</b>	(BRK)*	(available on 24 and 25 Series only)							
<b>Trim Options</b>									
FSA	Electric Lock or Unlock-Fail Safe (FSA device required)								
FSE	Electric Lock or Unlock-Fail Secure (FSE device required)								
CON	Allegion Connect								
<b>Other Information or Accessories</b>									
CYL	Include Cylinder with Trim								
KD	Cylinder Keyed Different								

### Door Thickness

Specify door thickness other than 1 3/4"

\*New finishes and levers are available on select 24 and 25 Series.

## HOW TO ORDER CLOSERS, COMPONENTS, PARTS & ACCESSORIES

1. **Identify** the closer series; 1460, 2030, 4040XP, 4210T, 4310ME, 4640, 6030, etc.
2. Determine if any **additional information** is required, such as: handing, finish, spring size, voltage, etc.
3. Order the material using suffix number with the description and include all necessary information.  
**Examples: 4111 Closer x RH x CUSH x AL or 4040SE Closer x 24v x DKBRZ**
4. For additional information on how to order specific closers, please see the 'How to Order' page in each individual closer section of the **LCN General Catalog** or call **LCN Customer Care**.

### SPECIAL NOTES

1. All **RAL** custom finishes will be powder coated and metal covers (**list add \$10 for most series, list add \$30 for 1450 and 4050 series**) will be substituted for standard covers for all closers except the 1460 series. 1460 series closers may be custom finished but a **DS** cover (**list add \$30**) must be selected.
2. **LCN** offers more than 180 **RAL** custom finishes. There is a list add of (**\$35**) per closer for an **RAL** finish. Most series require a metal cover (**MC**) (**\$10 add**). **LCN** also offers a Brite Metallic (**MTLPC**) powder coat finish. There is a list add of (**\$60**) per closer for the **MTLPC** finish. Most series require a metal cover (**MC**) (**\$10 add**).
3. **LCN** plated list prices already include -72MC (1460 includes -72DS). Disregard the additional list add for metal cover (**MC**).
4. **LCN** powder finishes exceed **ANSI/BHMA standard A156.4** for corrosion resistance by at least a factor of four. **LCN** powder coat finishes combined with the **LCN Special Rust Inhibitor (SRI)** pre-treatment exceed this standard even further.
5. Special Rust Inhibitor (**SRI**) is a pretreatment that is applied prior to the **LCN** powder coat finish and greatly exceeds ANSI/BHMA Standard A156.4 for corrosion resistance. **LCN** requires an additional (**list add \$40**) charge per closer, component or part.
6. **LCN** plated finishes exceed **ANSI/BHMA standard A156.4** for corrosion resistance.
7. Optional **TORX** security screw packs can be substituted for standard screw packs on most closers. See '**Add for TORX Screw Pack**' for additional charge. In some cases, not all fasteners can be provided as **TORX**, consult factory for details.
8. **LCN** can mark individual closer boxes with door or opening #'s. Please specify 'itemized' when ordering. Markings (e.g., door number, stock reference numbers) on individual product cartons will be provided with no charge.
9. Special Template (**ST**) pricing is available by contacting **LCN Technical/Product Support** or **LCN Customer Care**.
10. All closers conform to standards **UL10C** and **UBC 7-2** (1997).
11. If an item or price is not listed in the **LCN August 12, 2017 Price List**, consult factory for availability & pricing.
12. Prices listed in the **LCN August 12, 2017 Price List** are subject to change without notice. The current '**Terms of Sale**' applies. All prices listed in the **LCN August 12, 2017** are in US dollars.

To order Falcon products, descriptive data should be in the same sequence as shown:

Line Item	Qty	Product	Outside		Inside		Hand	Latch	Strike	Dr. Thk	Ext	DIM	Additional Details
			DES	FIN	DES	FIN							
1	2	3	4	5	6	7	8	9	10	11	12	13	14

1. **LINE ITEM:** Line item number
2. **QTY:** Quantity
3. **PRODUCT:** Complete lock product or part number
4. **OUTSIDE DES:** Outside design code
5. **OUTSIDE FIN:** Outside finish code
6. **INSIDE DES:** Inside design code. Leave blank if same as outside design code.
7. **INSIDE FIN:** Inside finish code. Leave blank if same as outside finish code.
8. **HAND:** Hand of door. Only one hand allowed per line item.  
Example: RH = Right Hand, LH = Left Hand, RHR = Right Reverse, LHR = Left Reverse.

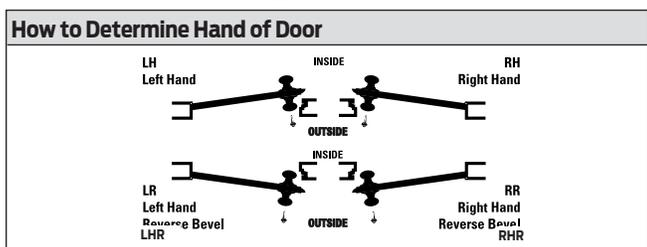

9. **LATCH:** Latch. Leave blank for standard or specify part number if non-standard latch is required. LLL = Less Latch.
10. **STRIKE:** Strike. Leave blank for standard or specify part number if non-standard strike is required. LLL = Less Strike.
11. **DR THK:** Door Thickness. Enter door thickness if non-standard. Example: 138 = 1 3/8", 214 = 2 1/4", 212 = 2 1/2".
12. **EXT:** Extension. Enter one of the following when doors 2" thick or greater are specified:
  - EE = Extended Equally
  - EI = Extended Inside
  - EO = Extended Outside
  - ED = Extended Differently
 EI or EO assumes the latch will be centered on a 1 3/4" door, to which material has been added.
13. **DIM:** Enter dimension for non-standard strike lip length and mortise cylinder or blocking ring length.
 

012 = 1/8"	118 = 1 1/8"
018 = 3/16"	114 = 1 1/4"
025 = 1/4"	138 = 1 3/8"
031 = 5/16"	112 = 1 1/2"
037 = 3/8"	158 = 1 5/8"
050 = 1/2"	134 = 1 3/4"
078 = 7/8"	200 = 2"
100 = 1"	400 = 4"
14. **ADDITIONAL DETAILS:** Enter detail for keying information and for special requirements.

## Multi-family How to Order - Closers

### SC70A Series

		Cylinder	Cover	Arm	Finish	Accessories
<b>STD**</b>	SC71A Standard					
<b>DEL</b>	SC71A Delay					
<b>Full cover</b>	SC70A-72					
<b>RW/PA**</b>	Regular with parallel arm shoe					
<b>HW/PA**</b>	Hold open with parallel arm shoe					
<b>HD**</b>	Heavy duty arm					
<b>DS**</b>	Dead stop arm					
<b>DS/HO</b>	Dead stop hold open arm					
<b>SS</b>	Spring stop arm					
<b>SS/HO</b>	Spring stop hold open arm					
<b>FA</b>	Forged arm					
<b>FA/HO</b>	Forged arm with hold open					
<b>Matte black**</b>	622					
<b>Aluminum</b>	689					
<b>Dark bronze</b>	695					
<b>Brass*</b>	696					
<b>Soffit shoe support</b>	SC70A-30					
<b>Blade stop spacer</b>	SC70A-61					
<b>Auxiliary shoe</b>	SC70A-62A					
<b>Top jamb plate</b>	SC70A-18					
<b>PA Plate</b>	SC70A-18PA					
<b>Full cover</b>	SC70A-72					

\*Contact customer service at 1-877-671-7011 for lead time information.

\*\*Matte Black (622) is only available on standard cylinders and RW/PA, HW/PA, DS and HD.

Note: SC71A models are adjustable sizes 1-6

### SC80A Series

		Cylinder	Cover	Arm	Finish	Accessories
<b>STD**</b>	SC81A Standard					
<b>DEL</b>	SC81A Delay					
<b>Slim cover</b>	SC80A-72					
<b>Full cover</b>	SC80A-72FC (optional, please specify)					
<b>RW/PA**</b>	Regular with parallel arm shoe					
<b>HW/PA**</b>	Hold open with parallel arm shoe					
<b>HD</b>	Heavy duty arm					
<b>DS**</b>	Dead stop arm					
<b>DS/HO</b>	Dead stop hold open arm					
<b>SS</b>	Spring stop arm					
<b>SS/HO</b>	Spring stop hold open arm					
<b>Matte black **</b>	622					
<b>Aluminum</b>	689					
<b>Dark bronze</b>	695					
<b>Brass*</b>	696					
<b>Soffit shoe support</b>	SC80A-30					
<b>Blade stop spacer</b>	SC80A-61					
<b>Auxiliary shoe</b>	SC80A-62A					
<b>Top jamb plate</b>	SC80A-18					
<b>Top jamb plate - full cover</b>	SC80A-18FC					
<b>PA Plate</b>	SC80A-18PA					
<b>PA Plate - full cover</b>	SC80A-18PAFC					
<b>Slim cover</b>	SC80A-72					
<b>Full cover</b>	SC80A-72FC					

\* Contact customer service at 1-877-671-7011 for lead time information.

\*\* Matte Black (622) is only available on standard cylinders and RW/PA, HW/PA, and DS.

Note: SC81A models have adjustable sizes 1-6

## SC60A Series

		Cylinder	Cover	Arm	Finish	Accessories
<b>STD**</b>	SC61A Standard					
<b>Slim cover</b>	SC60A-72 (optional, available with SC61A only, please specify)					
<b>RW/PA**</b>	Regular with parallel arm shoe					
<b>HW/PA**</b>	Hold open with parallel arm shoe					
<b>HD</b>	Heavy duty arm					
<b>DS**</b>	Dead stop arm					
<b>DS/HO</b>	Dead stop hold open arm					
<b>SS</b>	Spring stop arm					
<b>SS/HO</b>	Spring stop hold open arm					
<b>Matte black**</b>	622					
<b>Aluminum</b>	689					
<b>Dark bronze</b>	695					
<b>Brass</b>	696					
<b>Soffit shoe support</b>	SC60A-30					
<b>Blade stop spacer</b>	SC60A-61					
<b>Auxiliary shoe</b>	SC60A-62A					
<b>Top jamb plate</b>	SC60A-18					
<b>PA Plate</b>	SC60A-18PA					
<b>Slim cover</b>	SC60A-72					

\*\*Matte Black (622) is only available on standard cylinders and RW/PA, HW/PA, and DS arms.

Note: SC60A Series comes standard with less cover and all models have adjustable sizes 1-5.

## SC90A Series

		Cylinder	Size	Cover	Arm	Finish	Accessories
<b>STD*</b>	Standard						
<b>LBC</b>	Less backcheck option						
<b>1</b>	SC91A						
<b>3</b>	SC93A						
<b>4</b>	SC94A						
<b>Slim cover</b>	SC90A-72 (only available on SC93A/94A)						
<b>RW/PA</b>	Regular with parallel arm shoe						
<b>HW/PA</b>	Hold open with parallel arm shoe (only available on SC91A)						
<b>Soffit shoe support</b>	SC90A-30						
<b>Blade stop spacer</b>	SC90A-61						
<b>Auxiliary shoe</b>	SC90A-62A						
<b>Aluminum</b>	689						
<b>Dark bronze</b>	695						
<b>Plate</b>	SC90A-18 (available with SC93A/94A only)						
<b>Plate PA</b>	SC90A-18PA (available with SC93A/94A only)						
<b>Slim cover</b>	SC90A-72 (available with SC93A/94A only)						

\*STD comes with less cover and adjustable backcheck.

**Glynn-Johnson: Overhead Holders and Stops – How to Order**

**Example:**

**70      2      H   -   US26D   -   J**

Overhead series (70, 79, 81, 90, 10, 41, 45)

Size (1, 2, 3, 4, 5, or 6)\*

Function (H, F, HP, S or SE) For description of functions, refer to chart above.\*

Finish (US3, US4, US10, US10B, US26, US26D, US32, US32D, 652, SP4, SP10, SP28, SP313, SPBLK)

Option (ADJ, CJ, J, SHIM, SNB, SOC)\*

*\*Please refer to individual Overhead Series price book pages for availability of finish, size, function and options.*

## About Allegion

Allegion (NYSE: ALLE) creates peace of mind by pioneering safety and security. As a \$2 billion provider of security solutions for homes and businesses, Allegion employs more than 7,800 people and sells products in more than 120 countries across the world. Allegion comprises 23 global brands, including strategic brands CISA®, Interflex®, LCN®, Schlage® and Von Duprin®.

For more, visit [www.allegion.com](http://www.allegion.com)

KRYPTONITE ■ LCN ■  ■ STEELCRAFT ■ VON DUPRIN