

DCN516



DCN325



ED910



QL



MLX



E50

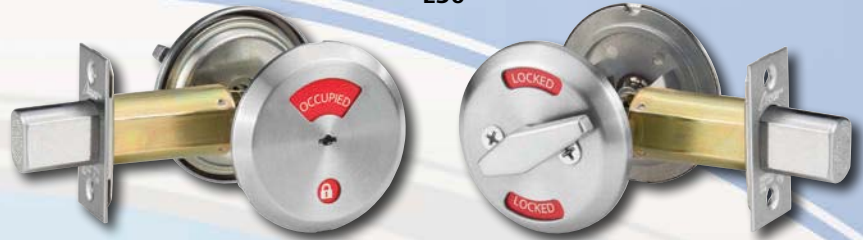

# Arrow 2022 Price Book Effective February 1, 2022



ASSA ABLOY

Experience a safer  
and more open world



**ASSA ABLOY**



**ARROW USA**

Dock 2  
225 Episcopal Road  
Berlin, CT 06307  
Phone: (800) 839-3157  
Fax: (800) 421-6615  
info@arrowlock.com

**ORDERS & CUSTOMER SERVICE:**

**Arrow Lock & Door Hardware**

P.O. Box 3075  
Salem, VA 24153  
Phone USA: 800-839-3157  
Fax: 800-421-6615

**INVOICE PAYMENTS ONLY**

**Arrow Lock Accounts Receivable**

P.O. Box 640711  
Pittsburgh, PA 15264

**RETURN GOODS ONLY (RGA# REQUIRED)**

**Arrow Lock & Door Hardware**

Dock 2  
225 Episcopal Road  
Berlin, CT 06307



**Arrow Canada**

160 Four Valley Drive  
Vaughan, ON L4K 4T9  
Canada

Phone: 1.800.461.3007

Fax: 1.800.461.8989

Note: The prices contained in this price book will vary from those in our Canadian price book.

# Table of Contents

<b>Terms &amp; Condition of Sale</b>	2	<b>Panic Devices</b>	
<b>Limited Warranty</b>	6	Features, Finishes, How to Order	61
<b>General Procedure/Finishes</b>	7	3000 Series	62
<b>Mortise Locks</b>		4000 Series	65
AM Series	8	Electrified Options	68
BM Series	11	S1150/S1250	69
<b>Cylindrical Locks</b>		ED910/PEC910 Series	69
QL Series	26	Accessories & Mullions	71
GL Series	28	<b>Closers and Operators</b>	
HK Series	30	7700 Series	74
MK Series	32	7800/7900 Series	75
MLX Series	36	DCN300 Series	77
RK Series	38	DCN500 Series	78
RL Series	39	5016N Series	79
RLX Series	41	<b>Alarmed Hardware</b>	
<b>Auxiliary Locks</b>		AL500 & 130N Series	80
DBX Series	43	<b>DISCONTINUED PRODUCTS</b>	
D Series	45	<b>Keyless Entry</b>	
E Series	46	V1 Series	83
N Series	49	V2 Series	85
Padlocks	51	V3 Series	86
<b>Keys &amp; Cylinders</b>		<b>Tubular Locks</b>	
Keys & Keying Charges	52	CL Series	87
Mortise & Rim Cylinders	53	<b>Auxiliary Locks</b>	
KIK, Lever & Deadbolt Cylinders	54	DB Series	89
IC Housings	55	<b>Closers and Operators</b>	
Arrow Pointe SFIC Cylinders	56	DC300 Series	90
Arrow Pointe Flex SFIC Cylinders	57	DC500 Series	91
Sliding Door Lock	57	<b>Alarmed Hardware</b>	
Cam Locks	58	300 & 400 Series	92
Plus IC Housings	59		
Cylinder Parts & Tools	60		



## Terms & Conditions of Sale

### Acceptance

ARROW LOCK reserves the right to decline an order, in whole or in part, when the type or quantity of goods or credit worthiness of the Purchaser is not satisfactory to us in our sole and absolute discretion.

Purchase Orders, Quote requests, Acknowledgements or the like issued by the Purchaser that have contrary standard terms and conditions are not binding on ARROW LOCK, unless such terms and conditions are approved in a separate written agreement by ARROW LOCK's authorized representatives. In the event of an acceptance of Purchaser's Purchase Order by ARROW LOCK, the Purchaser agrees that such acceptance is solely conditioned on Purchaser's acceptance of the terms and conditions set forth in this instrument, regardless of the terms and conditions specified in the Purchaser's Purchase order. The terms and conditions in Purchaser's Purchase order which conflict with terms and conditions of this instrument shall be disregarded and are hereby rejected, and this instrument shall constitute the entire agreement between ARROW LOCK and the Purchaser.

In the event that ARROW LOCK does not enforce or require strict performance of any term or condition hereof, or of any other document, instrument or other agreement relating to goods sold, such lack of enforcement or requirement of strict performance will not waive, affect or diminish any right of ARROW LOCK to enforce or require strict performance of such term or condition in the future.

### Prices

All prices are subject to change without notice and are not guaranteed. All shipments will be made at prices in effect at the time of order acceptance.

Possession of this price list does not constitute an agreement to sell. We reserve the right to correct clerical, stenographic and other obvious errors at any time.

### Terms

2% 10 net 30 days after invoice date.

It is understood that ARROW LOCK may impose and charge a finance charge which is the lesser or one and one-half percent (1-1/2%) per month or the highest rate allowed by law on any amount which becomes past due and delinquent. Additionally the customer shall be responsible for all collection costs, court costs and reasonable attorney's fees (where allowed by law) in connection with the recovery of any delinquent amount.

### Freight

All orders are shipped FOB factory/warehouse, except as expressly provided below. When delivered to the Transportation Company, the Purchaser assumes the risk of loss or damage in transit.

Customer orders with net product value in excess of \$5,000.00 will be shipped prepaid by ARROW LOCK's carrier of choice and routing to a single destination point in the United States.

Customer orders with net product value less than \$5,000.00 will be shipped prepaid by ARROW LOCK's carrier of choice and routing and shipping and handling charges will be added to customer's invoice.

If the customer requests an expedited method of shipment such as "Next Day Air" the charges will be prepaid by ARROW LOCK and the full rate for the service, as published by the carrier, will be added to the customer's invoice.

Great Grand Master keys, Grand Master keys, Master keys, Construction Master keys, Control Keys, which are shipped separate from customer order for security reasons, on orders with net product value in excess of \$5,000 will be shipped prepaid by ARROW LOCK's carrier of choice. If the total order value is less than \$5,000.00, the shipping charges will be added to customer's invoice.

ARROW LOCK will pack, mark and ship the products according to its standard procedures for shipment, unless the parties agree, in writing, that ARROW LOCK will comply with any special instructions provided by the customer. Special instructions must be submitted, in writing, at time of order placement. Compliance with special instructions may result in an increased price.

# Terms & Conditions of Sale

## Minimum Invoice

Minimum invoice for complete product is \$200.00 net product value. The minimum invoice for parts orders is \$100.00 net product value. In the event that the net product value does not meet the required net minimum, ARROW LOCK may, at its sole discretion (a) apply a minimum order charge, (b) reject the order or (c) waive the minimum requirement provided that the waiver of the requirement for one order shall not constitute a waiver of the requirement for any future orders.

This policy does not include the following: Cut (bitted) Keys of any type, Master Keyed Cylinders, Master Keyed Padlocks and factory-generated bitting Lists.

Same day order expedites will be invoiced at book net.

## Quotations

If ARROW LOCK elects to offer a quote; such quote will be valid until the expiration date on that quote. Complete shipment of the order must be accepted by Purchaser within standard lead times.

The quote number must be referenced on the order. Any invoiced order that has the incorrect discount applied to it and did not have the quote number written on the order will have a service fee of \$100.00 net DEDUCTED from any sales credit issued for the difference in discount.

The quote is null and void if the Purchase Order does not include ALL product lines listed on the quote or if the quantities for an item covered by the quote deviate by 10% or more.

With the issuance and acceptance of a quote for the purchase of products, the Purchaser agrees that products so purchased will not be resold or transferred to any Distributor not authorized by ARROW LOCK to sell its products. This would be inclusive of branches of the quoted Distributor. Failure to abide by this restriction may result in the Distributor's ineligibility for Price Concession Authorizations, or other actions in ARROW LOCK's discretion.

ARROW LOCK and its sales representatives reserve the right, in their sole discretion and for any reason, to refuse a Distributor's request to quote a price other than ARROW LOCK's standard list price and regardless of whether ARROW LOCK or its sales representatives have previously quoted discounted prices to the Distributor on some or all of its orders.

## Non-Cataloged Products

Products not cataloged or listed in this price book will be considered as special products, and will not be manufactured without prior approval from ARROW LOCK. All non-cataloged goods cannot be changed or cancelled.

A minimum special handling charge of \$50.00 will be added for non-cataloged product. Any additional labor or material required will be charged accordingly. Any additional labor or material required will be charged accordingly.

Special products require special handling, and therefore standard lead times may not apply. Please consult with your Sales Representative for further details.

## Change or Cancellation of Orders

Changes or cancellations to an order will result in a charge of costs for material and labor expenses that have been incurred prior to notification from customer. Handling charges are billed on customer's original order. If products have already been made and/or are located in the shipping room, a 45% restocking fee will apply.

Arrow Express Orders may not be changed or cancelled.

Except for the reasons stated above, all change requests must be submitted in writing to customer Service within two (2) business days of receipt of acknowledgement of the order.

## Add-On Orders to Quote

Any new order requesting special pricing to match an existing quote number, which has already been ordered, will be accepted up to sixty (60) days after the acknowledgement of the original order. All add-on orders must reference the original factory order number and the corresponding quote number to receive the quoted pricing discount. Add-on orders for stock will not be accepted.



## Terms & Conditions of Sale

### Delivery

Orders will be acknowledged and given a scheduled delivery date based on estimated manufacturing lead times. Complete information is required to process all orders. Orders with insufficient information for processing (i.e. keying information, door sizes, etc.) may be subject to extended lead times which are relative to the time required in obtaining the necessary information for order processing. Manufacturing lead time will begin once all information is received to process an order. ARROW LOCK will use reasonable efforts to deliver products as estimated, but makes no guarantees as to delivery dates.

ARROW LOCK will not be liable for back charges incurred based on availability of product or as a result of delays in delivery caused by insufficient information required to process an order.

ARROW LOCK will not be held responsible for delays in delivery caused by strikes, fires, floods or any other causes beyond our control, including the delivery of material to us. Under no circumstances shall ARROW LOCK be liable or accountable for consequential damages due to failure of delivery.

### Claims

In the event of Company or customer error, claims for shortages, pricing errors and/or incorrectly filled orders must be submitted in writing to Customer Service within thirty (30) days from receipt of material.

Any claims for shortages or damage by the Carrier must be made by the customer directly to the Carrier.

### Invoice Deduction

An ARROW LOCK Sales Representative or Customer Service Representative must be notified of any disputed invoices within sixty (60) days from the date of invoice. Deductions should only be taken for the disputed amount and the balance of the invoice is due and payable within standard payment terms.

### Returned Goods

It is the policy of ARROW LOCK to not accept returns of any materials that are correctly furnished as per the Distributor's Purchase Order. Return of product due to customer order error or accommodation must be pre-arranged with ARROW LOCK and approved in writing by Sales Management.

All products returned as "Goodwill" must meet the following criteria to be considered a return:

- Be in original, unmarked, and undamaged cartons
- Be valued in excess of \$200.00 net
- Shipped and invoiced within the previous one-hundred twenty (120) days
- Custom, non-cataloged goods, master-keyed or ARROW LOCK Arrow Express shipped products are not returnable

A MINIMUM restocking fee of 45% will be charged. Upon receipt and verification by ARROW LOCK that the returned merchandise meets the foregoing conditions, a credit will be issued for the original invoice amount less the MINIMUM 45% restocking fee. Defective goods and "Goodwill" products that meet the foregoing criteria may be returned by fulfilling the following conditions:

- Send an RGA request in writing to the ARROW LOCK Sales Representative serving the Purchaser's area
- Ensure the RGA labels that are sent to Purchaser by ARROW LOCK are visible on return goods shipment
- Ensure that the RGA number appears on the return shipment label and is legible
- Return the authorized merchandise within sixty (60) days from the date of RGA issuance date
- Return shipments must be freight prepaid to the location specified on the RGA. ARROW LOCK is not liable for damages to product during shipping.

No credit may be taken or issued prior to RGA approval and receipt of product. All defective goods within the terms of our limited warranty may be returned for credit or replacement.





**ASSA ABLOY**

February 1, 2022

Limited Warranty/  
Conditions of Sale

# Terms & Conditions of Sale

## Taxes

Prices do not include any present or future Federal, State, or Local property, license, privilege, sales, use, and excise, gross receipts or other like taxes or assessments, which may result from transactions or any services performed in connection herewith.

## Governing Law

The rights and obligations of the parties shall be governed by the laws of the State of New York, excluding any conflicts of law provisions. The United Nations Convention on Contracts for the International Sale of Goods shall not apply to this Agreement.

## Limited Warranty

The Terms and Conditions outlined above are subject to ARROW LOCK Limited Warranty, which is included in this Price List and incorporated herein by reference.

## Product Modifications

ARROW LOCK products are not designed for or intended for aftermarket modification. The warranty on ARROW LOCK products becomes void if the product is modified in any way, regardless of whether the modification causes or contributes to any alleged defect. Warranty voiding modifications include, but are not limited to, third-party electrification of non-electric products and/or the installation of non-approved or non-ARROW LOCK components.

If an ARROW LOCK product is modified it no longer meets industry certification and quality control standards applicable to the original product and is no longer a genuine ARROW LOCK product. A modified product may not be sold as an ARROW LOCK product and no ARROW LOCK trademarks or certification marks based on the original ARROW LOCK product, such as U.L. or ANSI/BHMA marks, may appear anywhere on the modified product or on any packaging, literature or instructions sold with the modified product.

All original ARROW LOCK packaging and literature carrying ARROW LOCK trademarks and must be destroyed if the original ARROW LOCK product is modified. Portions of the product that carry an ARROW LOCK trademark or certification mark, such as mortise faceplates, lock bodies, etc. must be discarded and/or replaced by the party making the modification. U.L. and other certification testing and marking are also the responsibility of the party making modification. The use of ARROW LOCK trademarks on modified products constitutes trademark infringement.

## Individual Components

Component parts including but not limited to latches sold separate from locksets are intended to be sold as replacement components for appropriate ARROW LOCK products only. All other uses require prior written approval from ARROW LOCK.

## Fire-Rated Openings

Any retrofit or other field modification to a fire-rated opening can potentially impact the fire rating of the opening, and ARROW LOCK makes no representations or warranties concerning what such impact may be in any specific situation. When retrofitting any portion of an existing fire-rated opening, or specifying and installing a new fire-rated opening, please consult with a code specialist or local code official (Authority Having Jurisdiction) to ensure compliance with all applicable codes and ratings.

## Technical Information and Advice

(a) All designs, data, and specifications provided by ARROW LOCK are proprietary and will not be disclosed or reused by customer without the prior written consent of ARROW LOCK; (b) ARROW LOCK assumes no obligation or liability for any advice given by ARROW LOCK, the results obtained, or damages incurred, and all such advice is given and accepted at customer's risk.

## Trademark Use

ARROW LOCK is a registered trademark of ARROW LOCK Manufacturing Company.

Other product brand names may be trademarks or registered trademarks of their respective owners and are mentioned for reference purposes only.

Experience a safer  
and more open world



# Limited Warranty

## Limited Warranty

ARROW LOCK warrants that its products sold under the ARROW LOCK trade name in the United States of America are free from defects in workmanship and materials under normal use and service.

This warranty does not cover defects or damage arising from improper installation, lack of or improper maintenance, improper storage, shipping and handling, corrosion, erosion, ordinary wear and tear, misuse, abuse, accident, unauthorized service, or use with unauthorized non-ARROW LOCK products or parts. This warranty is void if any modification is made to the warranty product, regardless of whether the modification causes or contributes to the alleged defect. All modifications are made at the risk of the party making the modification.

The only liability of ARROW LOCK in tort or contract whether under this warranty or otherwise shall be limited to the repair or replacement of any product or component part which shall prove defective as covered by this warranty. The warranty period after delivery to the original purchaser in all cases is as follows:

### Locks

AM & BM Series .....	5 Years
GL Series .....	5 Years
HK Series .....	10 Years
MLX Series .....	10 Years
QL Series .....	10 Years
RK & RL Series .....	5 Years
RLX Series .....	10 Years

### Door Controls

5016N Series .....	10 Years
7700 Series .....	1 Year
7800 & 7900 Series .....	2 Years
DCN300 Series .....	5 Years Limited
DCN500 Series .....	10 Years

### Exit Devices

3000 & 4000 Series .....	5 Years
ED910 & PEC910 Series .....	10 Years
S1150 & S1250 Series .....	3 Years

### Other

All other ARROW LOCK products.....1 year

## Warranty Requirements for Cylinders Factory or Field Combined

Cylinders shall be periodically lubricated depending on environmental conditions. Petroleum based lubricant is recommended. Petroleum based liquid lubricants should only be used in cylinders in harsh or corrosive environments and should never be mixed with dry lubricants.

### Warranty for cylinders Field Combined

1. Keys shall be cut to the ARROW LOCK key biting specifications required for the particular keyway and depth system.
2. All pin lengths shall be selected according to prevailing factory standards.
3. Original ARROW LOCK cylinder components, including pin tumblers and key blanks, shall be used. We reserve the right to void the warranty if we deem that a malfunction is a result of non-original components which do not conform to ARROW LOCK® standards.

### Keying Systems

All bittings shall be originated or authorized by the ARROW LOCK Key Systems Department to be compatible with one another in a specific type of cylinder (conventional, security, high security, interchangeable core, removable core) and within a particular keying system.



# General Procedure/Finishes

## General Procedure

ARROW LOCK will not pay for the cost of repair, replacement, or associated charges under this warranty unless prior written authorization has been given by ARROW LOCK.

Refer to our Returned Goods Policy regarding the return of a product or component part believed to be defective as covered by this warranty. A brief description of the defect will be required. Product will be examined upon return. In the event such examination reveals a defect covered by this warranty, the product will be repaired or replaced.

THIS WARRANTY IS IN LIEU OF ALL OTHER EXPRESS WARRANTIES. TO THE EXTENT PERMITTED BY LAW, ALL IMPLIED WARRANTIES ARE LIMITED TO THE DURATION OF THIS WARRANTY. ARROW LOCK MANUFACTURING COMPANY SHALL NOT BE LIABLE FOR ANY INCIDENTAL OR CONSEQUENTIAL DAMAGES. NO AGENT, SALES REPRESENTATIVE OR DEALER HAS THE AUTHORITY TO INCREASE OR ALTER THE OBLIGATIONS OF THIS WARRANTY.

SOME STATES DO NOT ALLOW LIMITATIONS ON HOW LONG AN IMPLIED WARRANTY LASTS OR THE EXCLUSION OR LIMITATION OF INCIDENTAL OR CONSEQUENTIAL DAMAGES, SO THE ABOVE LIMITATIONS OR EXCLUSIONS MAY NOT APPLY TO YOU.

THIS WARRANTY GIVES YOU SPECIFIC LEGAL RIGHTS, AND YOU MAY ALSO HAVE OTHER RIGHTS WHICH VARY FROM STATE TO STATE.

## Finishes

Description	Arrow Code	BHMA Code	U.S. Code
Bright brass	03	605	US3
Satin brass	04	606	US4
Antique brass	05A	609	US5
Satin bronze	10	612	US10
Dark oxidized satin bronze, oil rubbed	10B	613	US10B
Dark oxidized satin bronze, equivalent	10BE	613E	US10BE
Dark oxidized satin bronze, clear coated	10BP	614	US10BL
Satin nickel	15	619	US15
Bright chromium plated	26	625	US26
Satin chromium plated	26D	626	US26D
Bright stainless steel	32	629	US32
Satin stainless steel	32D	630	US32D

Description	Arrow Code	BHMA Code	
Aluminum painted or powder coated	AL	689	-
Black painted or powder coated	BLK	693	-
Dark bronze painted or powder coated	BRZ/DBZ	690	-
Satin brass painted or powder coated	GL	696	-
Light bronze painted or powder coated	LBZ	691	-
Red painted or powder coated	RD	-	-
Black suede powder coated	BSP	-	-

- Not all finishes are available for all product lines. Consult product sections for applicable finishes.

# AM Series

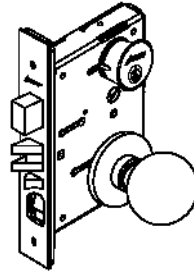

**Features**

Certification	BHMA A156.13, Series 1000, Operationsl Grade 1, UL Listed
Door Thickness	1-3/4"
Strike	Standard: ANSI 1-1/4" x 4-7/8", straight lip, with box; curved lip available
Latch	3/4" throw, stainless steel
Bolt	1" throw, stainless steel
Backset	2-3/4"
Cylinder	Standard: 6-pin, solid brass, 2 nickel-silver keys; IC prep available
Handing	Handed, field reversible without disassembling lock case
Case Quantity	10
Average Case Weight	58 lbs.
Warranty	5 years

Available Finishes	Arrow Code	BHMA Code	U.S. Code
Bright brass	03	605	US3
Satin brass	04	606	US4
Satin bronze	10	612	US10
Dark oxidized satin bronze, oil rubbed	10B	613	US10B
Bright chromium plated	26	625	US26
Satin chromium plated	26D	626	US26D

**How to Order**

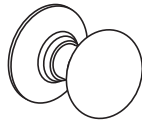
Function	<b>AM11</b>
Trim	<b>AM11-TA</b>
Finish	<b>AM11-TA-26D</b>
Strike	<b>AM11-TA-26D-460</b>
Handing	<b>AM11-TA-26D-460-RH</b>
Keying	<b>AM11-TA-26D-460-RH-KD-AR</b>



TA

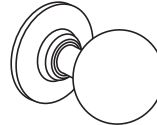

BD

## Non-Keyed Functions

Function	ANSI	Description	26D	03, 04, 10, 10B, 26
AM01	F01	Passage	\$484.00	\$524.00
AM02	F19	Privacy	\$565.00	\$605.00
AM07	-	Exit	\$632.00	\$652.00
AM26	F22	Privacy	\$565.00	\$605.00

## Single Cylinder Functions

Function	ANSI	Description	26D	03, 04, 10, 10B, 26
AM11	F12	Apartment	\$679.00	\$719.00
AM12	F07	Storeroom	\$671.00	\$711.00
AM13	F21	Front Door	\$679.00	\$719.00
AM17	F05	Classroom	\$671.00	\$711.00
AM19	F13	Dormitory	\$679.00	\$719.00
AM20	F20	Entrance	\$679.00	\$719.00
AM21	F08/F10	Entrance	\$679.00	\$719.00
AM22	F04	Office	\$671.00	\$711.00
AM23	-	Vestibule	\$671.00	\$711.00
AM24	-	Storeroom	\$671.00	\$711.00
AM27	-	Institutional Privacy	\$671.00	\$711.00

## Double Cylinder Functions

Function	ANSI	Description	26D	03, 04, 10, 10B, 26
AM31	F14	Storeroom	\$710.00	\$750.00
AM32	F09	Vestibule	\$706.00	\$746.00
AM33	-	Storeroom	\$706.00	\$746.00
AM34	-	Storeroom	\$710.00	\$750.00
AM37	F32	Classroom	\$706.00	\$746.00

## AM Series Knob Designs & Deadlocks



TG



TH

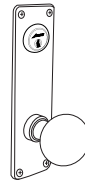

BG

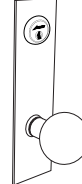

BH

### Non-Keyed Functions

Function	ANSI	Description	26D	03, 04, 10, 10B, 26
AM01	F01	Passage	\$502.00	\$542.00
AM02	F19	Privacy	\$583.00	\$623.00
AM07	-	Exit	\$641.00	\$661.00
AM26	F22	Privacy	\$583.00	\$623.00
AM08	-	Single Dummy	\$233.00	\$253.00
AM09	-	Full Dummy	\$426.00	\$466.00

### Single Cylinder Functions

Function	ANSI	Description	26D	03, 04, 10, 10B, 26
AM11	F12	Apartment	\$697.00	\$737.00
AM12	F07	Storeroom	\$689.00	\$729.00
AM13	F21	Front Door	\$697.00	\$737.00
AM17	F05	Classroom	\$689.00	\$729.00
AM19	F13	Dormitory	\$697.00	\$737.00
AM20	F20	Entrance	\$697.00	\$737.00
AM21	F08/F10	Entrance	\$697.00	\$737.00
AM22	F04	Office	\$689.00	\$729.00
AM23	-	Vestibule	\$689.00	\$729.00
AM24	-	Storeroom	\$689.00	\$729.00
AM27	-	Institutional Privacy	\$689.00	\$729.00

### Double Cylinder Functions

Function	ANSI	Description	26D	03, 04, 10, 10B, 26
AM31	F14	Storeroom	\$728.00	\$768.00
AM32	F09	Vestibule	\$724.00	\$764.00
AM33	-	Storeroom	\$724.00	\$764.00
AM34	-	Storeroom	\$728.00	\$768.00
AM37	F32	Classroom	\$724.00	\$764.00

### Deadlock Functions (No Trim)

Function	ANSI	Description	03, 04, 10, 10B, 26, 26D
AM40	F18	Cylinder One Side	\$491.00
AM41	F17	Cylinder x Thumbturn	\$518.00
AM42	F16	Double Cylinder	\$545.00
AM44	-	Classroom - Cylinder x Thumbturn	\$518.00

## BM Series

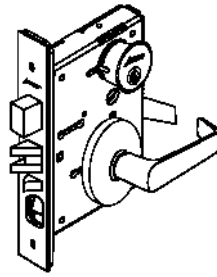

### Features

Certification	BHMA A156.13, Series 1000, Operations Grade 1, UL Listed
Door Thickness	1-3/4"
Strike	Standard: ANSI 1-1/4" x 4-7/8", straight lip, with box; curved lip available
Latch	3/4" throw, stainless steel
Bolt	1" throw, stainless steel
Backset	2-3/4"
Cylinder	Standard: 6-pin, solid brass, 2 nickel-silver keys; IC prep available
Handing	Handed, field reversible without disassembling lock case
Case Quantity	10
Average Case Weight	62 lbs.
Warranty	5 years

Available Finishes	Arrow Code	BHMA Code	U.S. Code
Bright brass	03	605	US3
Satin brass	04	606	US4
Satin bronze	10	612	US10
Dark oxidized satin bronze, oil rubbed	10B	613	US10B
Bright chromium plated	26	625	US26
Satin chromium plated	26D	626	US26D
Bright stainless steel	32	629	US32
Satin stainless steel	32D	630	US32D

### How to Order

Function	<b>BM11</b>
Trim	<b>BM11-XL</b>
Finish	<b>BM11-XL-26D</b>
Strike	<b>BM11-XL-26D-460</b>
Handing	<b>BM11-XL-26D-460-RH</b>
Keying	<b>BM11-XL-26D-460-RH-KD-AR</b>

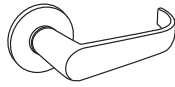

BRL



HSL



NL

## Non-Keyed Functions

Function	ANSI	Description	26D	03, 04, 10, 10B, 26	32, 32D
BM01	F01	Passage	\$510.00	\$552.00	\$564.00
BM02	F19	Privacy	\$583.00	\$625.00	\$637.00
BM07	-	Exit	\$640.00	\$661.00	\$667.00
BM26	F22	Privacy	\$583.00	\$625.00	\$637.00
BM08	-	Single Dummy	\$214.00	\$235.00	\$241.00
BM09	-	Full Dummy	\$402.00	\$444.00	\$456.00

## Single Cylinder Functions

Function	ANSI	Description	26D	03, 04, 10, 10B, 26	32, 32D
BM11	F12	Apartment	\$667.00	\$709.00	\$721.00
BM12	F07	Storeroom	\$646.00	\$688.00	\$700.00
BM13	F21	Front Door	\$667.00	\$709.00	\$721.00
BM17	F05	Classroom	\$646.00	\$688.00	\$700.00
BM19	F13	Dormitory	\$667.00	\$709.00	\$721.00
BM20	F20	Entrance	\$667.00	\$709.00	\$721.00
BM21	F08/F10	Entrance	\$667.00	\$709.00	\$721.00
BM22	F04	Office	\$646.00	\$688.00	\$700.00
BM23	-	Vestibule	\$646.00	\$688.00	\$700.00
BM24	-	Storeroom	\$646.00	\$688.00	\$700.00
BM27	-	Institutional Privacy	\$646.00	\$688.00	\$700.00

## Double Cylinder Functions

Function	ANSI	Description	26D	03, 04, 10, 10B, 26	32, 32D
BM31	F14	Storeroom	\$715.00	\$757.00	\$769.00
BM32	F09	Vestibule	\$696.00	\$738.00	\$750.00
BM33	-	Storeroom	\$696.00	\$738.00	\$750.00
BM34	-	Storeroom	\$715.00	\$757.00	\$769.00
BM37	F32	Classroom	\$696.00	\$738.00	\$750.00
BM38	-	Classroom Security	\$789.00	\$831.00	\$843.00

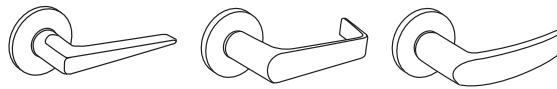

## BM Series Lever Designs

 JL<sup>1</sup>

XL

VL

### Non-Keyed Functions

Function	ANSI	Description	26D	03, 04, 10, 10B, 26	32, 32D
BM01	F01	Passage	\$604.00	\$646.00	\$658.00
BM02	F19	Privacy	\$677.00	\$719.00	\$731.00
BM07	-	Exit	\$687.00	\$708.00	\$714.00
BM26	F22	Privacy	\$677.00	\$719.00	\$731.00
BM08	-	Single Dummy	\$261.00	\$282.00	\$288.00
BM09	-	Full Dummy	\$496.00	\$538.00	\$550.00

### Single Cylinder Functions

Function	ANSI	Description	26D	03, 04, 10, 10B, 26	32, 32D
BM11	F12	Apartment	\$761.00	\$803.00	\$815.00
BM12	F07	Storeroom	\$740.00	\$782.00	\$794.00
BM13	F21	Front Door	\$761.00	\$803.00	\$815.00
BM17	F05	Classroom	\$740.00	\$782.00	\$794.00
BM19	F13	Dormitory	\$761.00	\$803.00	\$815.00
BM20	F20	Entrance	\$761.00	\$803.00	\$815.00
BM21	F08/F10	Entrance	\$761.00	\$803.00	\$815.00
BM22	F04	Office	\$740.00	\$782.00	\$794.00
BM23	-	Vestibule	\$740.00	\$782.00	\$794.00
BM24	-	Storeroom	\$740.00	\$782.00	\$794.00
BM27	-	Institutional Privacy	\$740.00	\$782.00	\$794.00

### Double Cylinder Functions

Function	ANSI	Description	26D	03, 04, 10, 10B, 26	32, 32D
BM31	F14	Storeroom	\$809.00	\$851.00	\$863.00
BM32	F09	Vestibule	\$790.00	\$832.00	\$844.00
BM33	-	Storeroom	\$790.00	\$832.00	\$844.00
BM34	-	Storeroom	\$809.00	\$851.00	\$863.00
BM37	F32	Classroom	\$790.00	\$832.00	\$844.00
BM38	-	Classroom Security	\$883.00	\$925.00	\$937.00

<sup>1</sup> JL trim design not available in 32 or 32D finish.

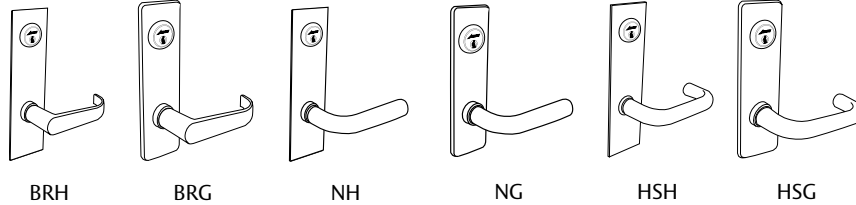
**ASSA ABLOY**

## BM Series Lever Designs

### Non-Keyed Functions

Function	ANSI	Description	26D	03, 04, 10, 10B, 26	32, 32D
BM01	F01	Passage	\$554.00	\$596.00	\$608.00
BM02	F19	Privacy	\$627.00	\$669.00	\$681.00
BM07	-	Exit	\$662.00	\$683.00	\$689.00
BM26	F22	Privacy	\$627.00	\$669.00	\$681.00
BM08	-	Single Dummy	\$236.00	\$257.00	\$263.00
BM09	-	Full Dummy	\$446.00	\$488.00	\$500.00

### Single Cylinder Functions

Function	ANSI	Description	26D	03, 04, 10, 10B, 26	32, 32D
BM11	F12	Apartment	\$711.00	\$753.00	\$765.00
BM12	F07	Storeroom	\$690.00	\$732.00	\$744.00
BM13	F21	Front Door	\$711.00	\$753.00	\$765.00
BM17	F05	Classroom	\$690.00	\$732.00	\$744.00
BM19	F13	Dormitory	\$711.00	\$753.00	\$765.00
BM20	F20	Entrance	\$711.00	\$753.00	\$765.00
BM21	F08/F10	Entrance	\$711.00	\$753.00	\$765.00
BM22	F04	Office	\$690.00	\$732.00	\$744.00
BM23	-	Vestibule	\$690.00	\$732.00	\$744.00
BM24	-	Storeroom	\$690.00	\$732.00	\$744.00
BM27	-	Institutional Privacy	\$690.00	\$732.00	\$744.00

### Double Cylinder Functions

Function	ANSI	Description	26D	03, 04, 10, 10B, 26	32, 32D
BM31	F14	Storeroom	\$759.00	\$801.00	\$813.00
BM32	F09	Vestibule	\$740.00	\$782.00	\$794.00
BM33	-	Storeroom	\$740.00	\$782.00	\$794.00
BM34	-	Storeroom	\$759.00	\$801.00	\$813.00
BM37	F32	Classroom	\$740.00	\$782.00	\$794.00
BM38	-	Classroom Security	\$833.00	\$875.00	\$887.00

## BM Series Lever Designs

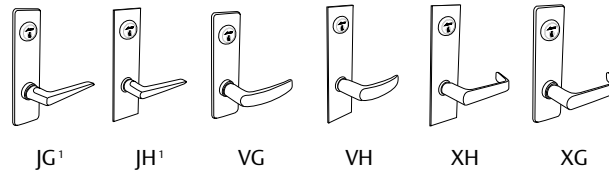

### Non-Keyed Functions

Function	ANSI	Description	26D	03, 04, 10, 10B, 26	32, 32D
BM01	F01	Passage	\$648.00	\$690.00	\$702.00
BM02	F19	Privacy	\$721.00	\$763.00	\$775.00
BM07	-	Exit	\$709.00	\$730.00	\$736.00
BM26	F22	Privacy	\$721.00	\$763.00	\$775.00
BM08	-	Single Dummy	\$283.00	\$304.00	\$310.00
BM09	-	Full Dummy	\$540.00	\$582.00	\$594.00

### Single Cylinder Functions

Function	ANSI	Description	26D	03, 04, 10, 10B, 26	32, 32D
BM11	F12	Apartment	\$805.00	\$847.00	\$859.00
BM12	F07	Storeroom	\$784.00	\$826.00	\$838.00
BM13	F21	Front Door	\$805.00	\$847.00	\$859.00
BM17	F05	Classroom	\$784.00	\$826.00	\$838.00
BM19	F13	Dormitory	\$805.00	\$847.00	\$859.00
BM20	F20	Entrance	\$805.00	\$847.00	\$859.00
BM21	F08/F10	Entrance	\$805.00	\$847.00	\$859.00
BM22	F04	Office	\$784.00	\$826.00	\$838.00
BM23	-	Vestibule	\$784.00	\$826.00	\$838.00
BM24	-	Storeroom	\$784.00	\$826.00	\$838.00
BM27	-	Institutional Privacy	\$784.00	\$826.00	\$838.00

### Double Cylinder Functions

Function	ANSI	Description	26D	03, 04, 10, 10B, 26	32, 32D
BM31	F14	Storeroom	\$853.00	\$895.00	\$907.00
BM32	F09	Vestibule	\$834.00	\$876.00	\$888.00
BM33	-	Storeroom	\$834.00	\$876.00	\$888.00
BM34	-	Storeroom	\$853.00	\$895.00	\$907.00
BM37	F32	Classroom	\$834.00	\$876.00	\$888.00
BM38	-	Classroom Security	\$927.00	\$969.00	\$981.00

<sup>1</sup> JH & JG trim designs not available in 32 or 32D finish.

# AM & BM Series Options

Strike Options	Lock Function	Specify	Price Add
Straight lip	All functions except 40, 41, 42, 44	460	Standard
	40, 41, 42, 44	456	Standard
Curved lip	Optional strike for all functions except 40, 41, 42, 44	466 (LH, RR)	No Add
		468 (RH, LR)	

Note: Straight Lip Strike = 1-1/8" Lip-to-Center

Curved Lip Strike = 1-1/4" Lip-to-Center

Keying & Cylinder Options	Specify	Price Add
Keyed different	KD	Standard
Master keyed	MK	\$14.75 per cylinder
Construction master keyed	CMK	\$9.30 per cylinder
Master keyed & construction master keyed	MK-CMK	\$24.05 per cylinder
O-Bitted	OB	No Add
Less cylinder	LC	--\$15.10
Lock prepared to accept 6-pin IC cylinder, less core	IC6	No Add
Lock prepared to accept 7-pin IC cylinder, less core	IC7	No Add

Miscellaneous Options	Specify	Price Add
Abrasive outside lever (BM Series)	113	\$66.40
Abrasive inside lever (BM Series)	114	\$66.40
Knurled outside lever (BM Series)	103	\$93.50
Knurled inside lever (BM Series)	104	\$93.50
Lead lined case	123	\$158.00
Lead lined knobs (inside & outside)	127	\$315.00
Lead lined roses (inside & outside)	133	\$237.00
Rabbeted front and strike	144	\$121.00
Hold back latch for 12 function	HB	\$64.30

<sup>2</sup> Only available for locks in 26, 26D, 32, or 32D finish. Not available for T Knob, B Knob, or any escutcheon design.

NOTE: Arrow mortise locks are designed for standard 1-3/4" door applications. See *Non-Cataloged Products* in the *Terms & Conditions of Sale* section for additional details.

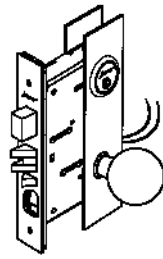

AM Series

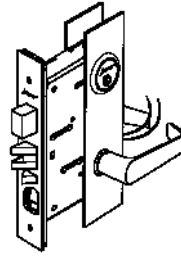

BM Series

## AM & BM Series Options

### Electrification Options (extended lead time required)

Description	Voltage	Specify	Price Add <sup>1</sup>
Fail-safe trim control (applied to 17 function)	12V AC/DC	177	\$536.00
	24V AC/DC	179	\$536.00
Fail-secure trim control (applied to 17 function)	12V AC/DC	181	\$536.00
	24V AC/DC	183	\$536.00
Latchbolt monitoring		LM <sup>2</sup>	\$310.00
Request to exit - authorized		RE	\$310.00
Security monitoring		SM <sup>2</sup>	\$585.00

<sup>1</sup> Electrification charges do not include price of locksets.

<sup>2</sup> LM and SM options cannot be combined.

**Fail-safe**      Power on locks outside lever  
                     Inside lever always free  
                     Latch retracted by keys when locked electrically

**Fail-secure**    Power off locks outside lever  
                     Inside lever always free  
                     Latch retracted by keys when locked electrically

**Latchbolt monitoring**  
                     Full extension of the latch monitored by a SPDT switch

**Request to exit - authorized egress**  
                     Inside trim monitored by an SPTD switch. Switch can be used to shunt a door alarm to allow egress, signal a control console when the trim is activated, or activate a door alarm.

**Security monitoring**  
                     Monitors, in series, solenoid status (locked or unlocked) and latch status (deadlatch position).

**Specifications**    12VAC/VDC @ 612mA  
                             24VAC/VDC @ 330mA

# AM & BM Series Parts

Strikes	Lock Function	Part No.	Price
Straight lip	All functions except 40, 41, 42, 44	460	\$37.85
	40, 41, 42, 44	456	\$37.85
Curved lip	All functions except 40, 41, 42, 44	466 (LH, RR)	\$37.85
		468 (RH, LR)	
Box Strike	For all strikes above	BX70	\$5.76

Cylinders & Related		Part No.	Price
Standard mortise cylinder		MC61-001	\$45.35
		MC61-AM2	\$45.35
Emergency key for privacy function		16L-207	\$2.08
Cylinder cams	For functions 12, 17, 22, 23, 24, 27, 32 (I/S), 33, 37	001	\$3.93
	For functions 11, 13, 19, 20, 21, 31, 32 (O/S), 34, 38, 40, 41, 42, 44	AM2	\$3.93
Cylinder collar & spring		16-113A	\$10.48
Mortise housing to accept 6-pin IC cylinder, less core		16CR-16X001	\$44.45
		16CR-16XAM2	\$44.45
Mortise housing to accept 7-pin IC cylinder, less core		16CR-27X001	\$44.45
		16CR-27XAM2	\$44.45
Housing cams	For functions 12, 17, 22, 23, 24, 27, 32 (I/S), 33, 37	16CR-001	\$3.93
	For functions 11, 13, 19, 20, 21, 31, 32 (O/S), 34, 38, 40, 41, 42, 44	16CR-AM2	\$3.93



### Parts & Accessories

Description	Lock Function	Part No.	Price
Faceplates	01, 24, 26	AM01-305	\$34.10
	02, 13, 19, 31	AM02-305	\$34.10
	07, 12, 17, 27, 32, 33, 37	AM12-305	\$34.10
	11, 21, 34	AM11-305	\$34.10
	38	AM15-305	\$34.10
	20	AM20-305	\$34.10
	22	AM22-305	\$34.10
	23	AM23-305	\$34.10
	40, 41, 42, 44	AM41-305	\$34.10
	Spindles	AM trim with H escutcheon	AM-385A
AM trim with G escutcheon or rose trim		AM-386A	\$26.60
BM trim with H escutcheon or rose trim		BM-385A	\$22.76
BM trim with G escutcheon		BM-386A	\$26.60
Thumbturn for sectional trim		16-17A	\$24.68
Emergency rose for privacy function with sectional trim		16-04A	\$11.44
Emergency key for privacy function		16L-207	\$2.08
BM Series rose		17-03-2	\$36.90
Stud for mounting plate		BM-94	\$1.00
Mounting plate for lever x rose trim		BM-93A	\$10.48
Standard screw pack		AM-201	\$2.95
Supplement screw pack for G escutcheon		AM-201G	\$1.12
Supplement screw pack for H escutcheon		AM-201H	\$1.12
Faceplate screw		16-306	\$0.44
Black nylon bushing insert		16-14	\$0.95
Lever handle set screw		17-388	\$1.00



## AM & BM Series Lockbodies

Lockbodies	Lock Function (specify handing - RH, LH, RR, or LR)	Part No.	Price
	01	AM01-LB	\$242.00
	02, 19	AM02-LB	\$335.00
	07, 12	AM12-LB	\$321.00
	11	AM11-LB	\$335.00
	13, 31	AM13-LB	\$335.00
	17, 32, 37	AM17-LB	\$321.00
For AM knobs	20	AM20-LB	\$335.00
	21, 34	AM21-LB	\$335.00
	22	AM22-LB	\$321.00
	23	AM23-LB	\$321.00
	24	AM24-LB	\$321.00
	26	AM26-LB	\$321.00
	27	AM27-LB	\$321.00
	33	AM33-LB	\$321.00
For deadlocks less trim	40, 41, 42	AM41-LB	\$309.00
	44	AM44-LB	\$309.00
	01	BM01-LB	\$242.00
	02, 19	BM02-LB	\$335.00
	07, 12	BM12-LB	\$321.00
	11	BM11-LB	\$335.00
	13, 31	BM13-LB	\$335.00
	17, 32, 37	BM17-LB	\$321.00
For BM levers	20	BM20-LB	\$335.00
	21, 34	BM21-LB	\$335.00
	22	BM22-LB	\$321.00
	23	BM23-LB	\$321.00
	24	BM24-LB	\$321.00
	26	BM26-LB	\$321.00
	27	BM27-LB	\$321.00
	33	BM33-LB	\$321.00
	38	BM38-LB	\$366.00

• Faceplates and screwpacks are not included with lockbodies.

### AM Knob Trims

Trim Design	Lock Function	Suffix No.	26D	03, 04, 10, 10B, 26
TA, BD	01, 12, 17, 22, 23, 24, 31, 32, 33, 34, 37	4	\$248.00	\$254.00
	11, 13, 19, 20, 21, 27	6	\$273.00	\$279.00
	02, 26	7	\$285.00	\$290.00
BG, BH, TG, TH	01	3	\$260.00	\$265.00
	12, 17, 22, 23, 24	4	\$260.00	\$265.00
	31, 32, 33, 34, 37	5	\$260.00	\$265.00
	11, 13, 19, 20, 21, 27	6	\$285.00	\$290.00
	02, 26	7	\$295.00	\$302.00

### BM Lever Trims

Trim Design	Lock Function	Suffix No.	26D	03, 04, 10, 10B, 26	32, 32D
BRL, HSL, NL	01, 12, 17, 22, 23, 24, 31, 32, 33, 34, 37, 38	4	\$302.00	\$328.00	\$347.00
	11, 13, 19, 20, 21, 27	6	\$328.00	\$355.00	\$373.00
	02, 26	7	\$339.00	\$363.00	\$382.00
JL <sup>1</sup> , VL, XL	01, 12, 17, 22, 23, 24, 31, 32, 33, 34, 37, 38	4	\$373.00	\$398.00	\$418.00
	11, 13, 19, 20, 21, 27	6	\$398.00	\$418.00	\$441.00
	02, 26	7	\$411.00	\$431.00	\$452.00
BRG, BRH, NG, NH, HSG, HSH	01	3	\$321.00	\$347.00	\$363.00
	12, 17, 22, 23, 24	4	\$321.00	\$347.00	\$363.00
	31, 32, 33, 34, 37, 38	5	\$321.00	\$347.00	\$363.00
	11, 13, 19, 20, 21, 27	6	\$347.00	\$373.00	\$390.00
	02, 26	7	\$358.00	\$382.00	\$403.00
JG <sup>1</sup> , JH <sup>1</sup> , VG, VH, XG, XH	01	3	\$398.00	\$418.00	\$438.00
	12, 17, 22, 23, 24	4	\$398.00	\$418.00	\$438.00
	31, 32, 33, 34, 37, 38	5	\$398.00	\$418.00	\$438.00
	11, 13, 19, 20, 21, 27	6	\$418.00	\$444.00	\$462.00
	02, 26	7	\$431.00	\$456.00	\$472.00

- Example - Trim for an "01" function: TA4 or BRL4 (specify finish).
  - Trim packs are supplied less cylinder. Each pack includes inside & outside trims, spindle, turnpiece (where applicable), & mounting screws.
- <sup>1</sup>JL, JG, & JH trim designs not available in 32 or 32D finish.

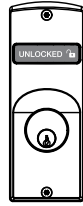
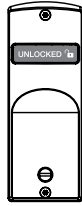
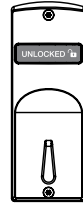
 ABE190  
ASC190

 ABE193  
ASC193

 ABE194  
ASC194

ASC197

## Mortise Indicators Escutcheon Kits

Available Finishes	Arrow Code	BHMA Code	U.S. Code
Bright Brass	605	605	US3
Satin Brass	606	606	US4
Satin Bronze	612	612	US10
Dark Oxide Satin Bronze Equivalent	613E	613E	US10BE
Bright Nickel	618	618	US14
Satin Nickel	619	619	US15
Bright Chromium Plated	625	625	US26
Satin Chromium Plated	626	626	US26D

Indicator Kits for Best® Mortise Locks	Part No.	Price
Keyed Functions <sup>1</sup>	ABE190	\$230.00
Cointurn for Emergency Override	ABE193	\$230.00
Thumbturn	ABE194	\$230.00

Indicator Kits for Schlage® Mortise Locks	Part No.	Price
Keyed Functions <sup>1</sup>	ASC190	\$230.00
Cointurn for Emergency Override	ASC193	\$230.00
Thumbturn	ASC194	\$230.00
No Input - Blank	ASC197	\$230.00

Options	Specify	Price
Unlocked/Locked - Green/Red	V10	No Add
Vacant/Occupied - Green/Red	V20	No Add
Icons Only - Green/Red	V30	No Add
Unlocked/Locked - White/Red	V40	No Add
Vacant/Occupied - White/Red	V50	No Add
Icons Only - White/Red	V60	No Add

<sup>1</sup> Supplied less cylinder.

# Mortise Indicators

## Parts

Description	Part No.	Price
Best® Sectional Escutcheon – Cylinder <sup>1</sup>	50-8800-2304	\$101.00
Schlage® Sectional Escutcheon – Cylinder <sup>1</sup>	50-8800-2303	\$101.00
Best® Sectional Escutcheon – Thumbturn (includes thumbturn) <sup>1,2</sup>	50-8800-0390	\$101.00
Schlage® Sectional Escutcheon – Thumbturn (includes thumbturn) <sup>1,2</sup>	50-8800-0389	\$101.00
Best® or Schlage® Sectional Escutcheon – No Input / Blank <sup>1</sup>	50-8800-2302	\$101.00
Best® or Schlage® Sectional Escutcheon – Cointurn (cointurn not included) <sup>1</sup>	50-8800-2301	\$98.00
Indicator Window	856F049	\$6.00
Display Assembly – Green Unlocked / Red Locked	858F241	\$69.00
Display Assembly – Green Vacant / Red Occupied	858F251	\$69.00
Display Assembly – Green Unlocked Icon / Red Locked Icon	858F261	\$69.00
Display Assembly – White Unlocked / Red Locked	858F271	\$69.00
Display Assembly – White Vacant / Red Occupied	858F281	\$69.00
Display Assembly – White Unlocked Icon / Red Locked Icon	858F291	\$69.00
Best® Spindle Cam – Thumbturn	855F619	\$14.00
Best® Spindle Cam – Cylinder / No Input / Blank <sup>2</sup>	855F707	\$14.00
Best® Spindle Cam – Cointurn (includes cointurn) <sup>1,2</sup>	855F747	\$17.00
Schlage® Spindle Cam – Cointurn (includes cointurn) <sup>1,2</sup>	50-8800-7318	\$17.00
Schlage® Spindle Cam – Thumbturn	50-8800-9322	\$14.00
Schlage® Spindle Cam – Cylinder / No Input / Blank <sup>2</sup>	50-8800-7314	\$14.00
Retaining Pad and Screw Kit	50-8800-0391	\$6.00
Mounting Plate	855F658	\$13.00
Screw Pack <sup>1</sup>	858F497	\$10.00
Template Kit	50-8800-9327	\$15.00

<sup>1</sup> Finish required.

<sup>2</sup> Prepared for standard 1-3/4" thick door. Contact factory for additional thicknesses.

# Mortise Indicators

## Cross-Reference Table

### Best® Mortise Locks

Sectional trim indicator kits are available to retrofit to Best® 45H, 34H or 35H series mortise locks. Kits can be ordered to be used on the inside, outside or both sides of the door. Each kit includes a single side indicator plate with mechanism, screw pack, plastic template and instructions.

- Kits available for use on sectional trim installations only
- Can only be used with H or R roses. Roses greater than 3-1/4" in diameter cannot be used.
- L and LT privacy functions will use a coin turn for emergency override

The following chart details the functions that can be accommodated.

Best® Function	Illustration	Description	Outside	Inside
L		Privacy F19	 ABE193	
LT		Privacy		
AB		Office F20	 ABE190*	
AT		Office F04		
RD		Classroom DL F29		
TA		Dormitory F12		
TD		Dormitory		
IND		Intruder F33		
INL		Intruder F32		
			 ABE194	
			 ABE190*	

\*Cylinder not included. Accepts a standard 1-1/8" mortise cylinder.

Function numbers, illustrations and descriptions above are from the Best® 40H series catalog. Refer to that catalog for more information and function details.



# Mortise Indicators

## Cross-Reference Table

### Schlage® Mortise Locks

Sectional trim indicator kits are available to retrofit to Schlage® L series mortise locks. Kits can be ordered to be used on the inside, outside or both sides of the door. Each kit includes a single side indicator plate with mechanism, screw pack, plastic template and instructions.

- Kits available for use on sectional trim installations only
- Can be used with A, B, C, AVA or MER roses. Roses greater than 3-1/4" in diameter cannot be used.
- L/LV9040 and L/LV9044 privacy functions will use a coin turn for emergency override

The following chart details the functions that can be accommodated.

Schlage® Function	Illustration	Description	Outside	Inside	
L/LV9040		Privacy F22	 ASC193	 ASC194	
L/LV9044		Privacy			
L/LV9050		Office F04	 ASC190*		 ASC190*
L/LV9456		Corridor F13			
L9473		Dormitory F21			
L/LV9060		Apartment Entrance Lock F09			
L/LV9071		Classroom Security F32			
L/LV9077		Classroom Security Holdback			
L/LV9457		Classroom Security F33			
L/LV9458		Classroom Security F34			
L9466		Store/utility Room Lock with Deadbolt F14	 ASC197		
L/LV9070		Classroom Lock F05			

\*Cylinder not included. Accepts a standard 1-1/8" mortise cylinder.

Function numbers, illustrations and descriptions above are from the Schlage® L series catalog. Refer to that catalog for more information and function details.

Experience a safer  
and more open world

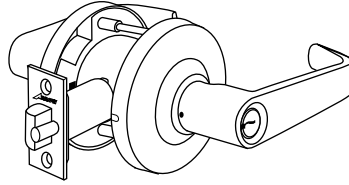
**Features**

Certification	BHMA A156.2, Series 4000, Grade 1, UL Listed
Freewheeling Lever Action	Standard
Door Thickness	Fits 1-3/8" to 1-3/4", factory set for 1-3/4"
Strike	ANSI 1-1/4" x 4-7/8"
Latch	2-3/4" backset, 1-1/8" front
Cylinder	Standard 6 Pin, solid brass, 2 nickel-plated brass keys, IC prep available
Handing	Non-handed
Case Quantity	6 per case
Average Case Weight	27 lbs.
Warranty	10 years

Available Finishes	Arrow Code	BHMA Code	U.S. Code
Bright Brass	03	605	US3
Dark Oxidized Satin Bronze, equivalent	613E	613E	US10BE
Satin Chromium Plated	26D	626	US26D
Black Suede Powder Coated <sup>1</sup>	BSP	-	-

**How to Order**

Function & Trim	<b>QL81-SB</b>
Finish	<b>QL81-SB-26D</b>
Strike	<b>QL81-SB-26D-306</b>
Latch	<b>QL81-SB-26D-306-Q71</b>
Keying	<b>QL81-SB-26D-306-Q71-ARKD</b>

Function	Description	03, 613E, 26D, BSP <sup>1</sup>
QL01-SB	Passage	\$224.00
QL72-SB	Privacy	\$261.00
QL81-SB	Entrance	\$291.00
QL82-SB	Storeroom	\$291.00
QL87-SB	Classroom	\$291.00
QL97-SB	Classroom Intruder	\$362.00

*** AVAILABLE THROUGH SELECT DISTRIBUTORS – CONTACT ARROW LOCK FOR MORE INFORMATION ***		
Rigid Lever Function	Description	03, 613E, 26D, BSP
QL02-SB	Privacy	\$261.00
QL11-SB	Entrance	\$291.00
QL12-SB	Storeroom	\$291.00
QL17-SB	Classroom	\$291.00
QL33-SB	Asylum	\$333.00
QL37-SB	Classroom Intruder	\$362.00
Freewheeling Function	Description	03, 613E, 26D
QL93-SB	Asylum	\$333.00

Specify SR trim for QL design with removable thru-bolts.

<sup>1</sup> Available through select distributors. Contact Arrow Lock for more information.

# QL Series

## Options & Parts

Keying & Cylinder Options	Specify	Price Add
Keyed different, AR keyway	ARKD	Standard
Keyed different, CS keyway	CSKD	No Add
Lock prepared to accept a 6- or 7-pin SFIC cylinder (not included)	IC	No Add
Lock prepared to accept Schlage LFIC cylinder (not included)	SIC <sup>1</sup>	\$25.00
Lock prepared to accept a Medeco 320201 or ASSA LFIC cylinder (not included)	LIC	\$25.00

<sup>1</sup> Not available with 10BP finish, 03 finish, or the QL97 function.

Latch Options	Spring Latch	Dead Latch	Price Add
2-3/4" backset x 1-1/8" front	Q73	Q71	Standard

Parts	Part No.	Price
Standard cylinder with tailpiece – AR keyway	C700HD	\$29.15
Standard cylinder with tailpiece – CS keyway	C700HD-CS	\$29.15
Strike	306	\$30.30
Latch - 2-3/4" backset	Q73 <sup>2</sup> or Q71 <sup>3</sup>	\$24.14
Latch - 2-3/8" backset (sold only as a separate part)	R22 <sup>2,4</sup> or R20 <sup>3,4</sup>	\$17.68
Screw pack	QL-201	\$2.14
Standard cylinder tailpiece	1001SC-44	\$2.95
Standard cylinder screw cap	SC-01	\$9.61
Standard cylinder cap pin	SC-02	\$3.47
Standard cylinder cap spring	SC-03	\$1.08
IC tailpiece kit (tailpiece & spacer for 6- & 7- pin cores)	RLX-44-201	\$5.70
SIC Tailpiece	QL-44S	\$15.94
LIC tailpiece	QL-44	\$3.60
LIC tailpiece retainer	QL-66	\$0.50
Alternate classroom intruder rose with red arrows	QL97-03A.26D	\$36.85

<sup>1</sup> Not available with 10BP finish, 03 finish, or QL97 function.

<sup>2</sup> Used only with non-keyed functions.

<sup>3</sup> Used only with keyed functions.

<sup>4</sup> Sold only as a separate part. Not tested to grade 1 specifications. If substituted for standard latch, grade 1 rating is voided.

# GL Series

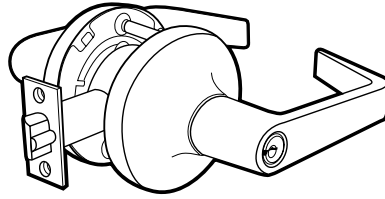

### Features

Certification	BHMA A156.2, Series 4000, Grade 1, UL Listed
Door Thickness	Fits 1-3/4" - 2", factory set for 1-3/4"
Strike	ANSI 1-1/4" x 4-7/8"
Latch	2-3/4" backset, 1-1/8" front
Cylinder	Standard: 6-pin, solid brass, 2 brass keys; IC prep available
Handing	Non-handed
Case Quantity	6
Average Case Weight	31 lbs.
Warranty	5 years

Available Finishes	Arrow Code	BHMA Code	U.S. Code
Satin Chromium Plated	26D	626	US26D

### How to Order

Function & Trim	<b>GL81-SR</b>
Finish	<b>GL81-SR-26D</b>
Strike	<b>GL81-SR-26D-306</b>
Latch	<b>GL81-SR-26D-306-G71</b>
Keying	<b>GL81-SR-26D-306-G71-KD-AR</b>

Function	ANSI	Description	26D
GL01-SR	F75	Passage	\$239.00
GL02-SR	F76	Privacy	\$279.00
GL08-SR	-	Single Dummy	\$128.00
GL81-SR	F109	Entrance	\$309.00
GL82-SR	F86	Storeroom	\$309.00
GL87-SR	F84	Classroom	\$309.00
GL97-SR	F110	Classroom Intruder	\$389.00

## GL Series Options & Parts

Strike & Latch Options	Specify	Price Add
ANSI Strike	306	Standard
Latch (keyed functions) - 2-3/4" backset, 1-1/8" front	G71	Standard
Latch (non-keyed functions) - 2-3/4" backset, 1-1/8" front	G73	Standard

Keying & Cylinder Options	Specify	Price Add
Keyed different	KD	Standard
Master keyed	MK	\$14.75 per cylinder
Construction master keyed	CMK	\$9.30 per cylinder
Master keyed & construction master keyed	MK-CMK	\$24.05 per cylinder
Keyed alike	KA	No Add
O-Bitted	OB	No Add
Less cylinder	LC	--\$9.70
Lock prepared to accept 6 or 7-pin SFIC cylinder, less core	IC	No Add

Parts	Part No.	Price
ANSI Strike	306	\$30.30
Standard dead latch (for keyed functions)	G71	\$24.14
Standard spring latch (for passage & privacy functions)	G73	\$24.14
Standard cylinder w/tailpiece	600HD-GL	\$29.15
Standard keyblank	K6A	\$1.46
Standard tailpiece	1001GL-44	\$2.95

### Alternate Latches (sold only as separate parts)

Backset	Description	Spring Latch	Dead Latch	Price
2-3/8" Backset	1" front	G72	G70	\$24.14
3-3/4" Backset	1-1/8" front	G83	G81	\$30.85
5" Backset	1-1/8" front	G93	G91	\$35.95

# HK Series

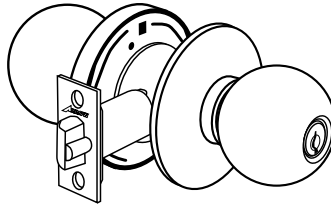

## Features

Certification	BHMA A156.2, Series 4000, Grade 1, UL Listed
Door Thickness	Fits 1-3/8" to 2" factory set to 1-3/4"
Strike	ANSI 1-1/4" x 4-7/8"
Latch	2-3/4" backset, 1-1/8" front
Cylinder	Standard 6 Pin, solid brass, 2 nickel-plated brass keys, IC prep available
Handing	Non-handed
Case Quantity	16
Average Case Weight	32 lbs.
Warranty	10 years

Available Finishes	Arrow Code	BHMA Code	U.S. Code
Bright Brass	605	605	US3
Dark Oxide Satin Bronze, clear coated	10BP	614	US10BL
Satin Stainless Steel	630	630	US32D

## How to Order

Function & Trim	<b>HK11-BB</b>
Finish	<b>HK11-BB-630</b>
Strike	<b>HK11-BB-630-306</b>
Latch	<b>HK11-BB-630-306-Q71</b>
Keying	<b>HK11-BB-630-306-Q71-ARKD</b>

Function	Description	10BP, 605, 630
HK01-BB	Passage	\$236.00
HK02-BB	Privacy	\$286.00
HK08-BB	Single Dummy	\$141.00
HK11-BB	Entrance	\$335.00
HK12-BB	Storeroom	\$335.00
HK17-BB	Classroom	\$335.00
HK33-BB	Asylum	\$367.00

Keying & Cylinder Options	Specify	Price Add
Keyed different, AR keyway	ARKD	Standard
Keyed different, CS keyway	CSKD	No Add
Lock prepared to accept a 6- or 7-pin SFIC cylinder (not included)	IC	No Add

Latch Options	Spring Latch	Dead Latch	Price Add
2-3/4" backset x 1-1/8" front	Q73	Q71	Standard

# HK Series Parts

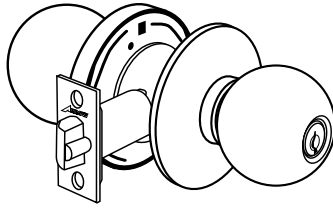

Parts	Part No.	Price
Standard cylinder with tailpiece – AR keyway	C700HD	\$29.15
Standard cylinder with tailpiece – CS keyway	C700HD-CS	\$29.15
Strike	306	\$30.30
Latch - 2-3/4" backset	Q73 <sup>1</sup> or Q71 <sup>2</sup>	\$24.14
Latch - 2-3/8" backset (sold only as a separate part)	R22 <sup>1,3</sup> or R20 <sup>2,3</sup>	\$17.68
Screw pack	HK-201	\$5.70
Standard cylinder tailpiece	1001SC-44	\$2.95
Standard cylinder screw cap	SC-01	\$9.61
Standard cylinder cap pin	SC-02	\$3.47
Standard cylinder cap spring	SC-03	\$1.08
IC tailpiece kit (tailpiece & spacer for 6- & 7-pin cores)	HK-44-201	\$5.70

<sup>1</sup> Used only with non-keyed functions.

<sup>2</sup> Used only with keyed functions.

<sup>3</sup> Sold only as a separate part. Not tested to grade 1 specifications. If substituted for standard latch, grade 1 rating is voided.

# MK Series

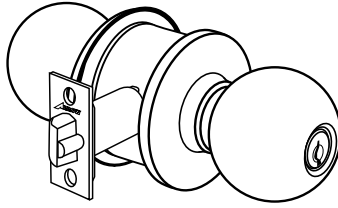

### Features

Certification	BHMA A156.2, Series 4000, Grade 2, UL Listed
Door Thickness	Fits 1-3/8" - 1-3/4", factory set for 1-3/4"
Strike	Standard: T-strike, 1-1/8" x 2-3/4"; alternate strikes available
Latch	Standard: 2-3/4" backset, 1-1/8" front; alternate latches available
Cylinder	Standard: 6-pin, keyed 5, solid brass, 2 brass keys; IC prep available
Handing	Non-handed
Case Quantity	12
Average Case Weight	21 lbs.
Warranty	1 year

Cylindrical Locks

Available Finishes	Arrow Code	BHMA Code	U.S. Code
Bright brass	03	605	US3
Satin brass	04	606	US4
Antique brass	05A	609	US5
Satin bronze	10	612	US10
Dark oxidized satin bronze, oil rubbed	10B	613	US10B
Dark oxidized satin bronze, equivalent	10BE	613E	US10BE
Satin nickel	15	619	US15
Bright chromium plated	26	625	US26
Satin chromium plated	26D	626	US26D

### How to Order

Function	<b>MK11</b>
Trim	<b>MK11-TA</b>
Finish	<b>MK11-TA-26D</b>
Strike	<b>MK11-TA-26D-300</b>
Latch	<b>MK11-TA-26D-300-114</b>
Keying	<b>MK11-TA-26D-300-114-KD-AR</b>



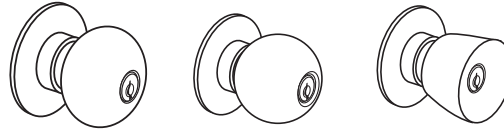

TA

BD¹

DD¹

**Non-Keyed Functions**

Function	ANSI	Description	03, 26D	04, 05A, 10, 10B, 10BE, 15, 26
MK01	F75	Passage	\$91.00	\$101.00
MK02	F76	Privacy	\$97.00	\$107.00
MK03	F111	Communicating Passage	\$91.00	\$96.00
MK04	F77	Patio	\$98.00	\$108.00
MK05	F78	Communicating	\$133.00	\$143.00
MK08	-	Single Dummy	\$65.00	\$70.00

**Single Cylinder Functions**

Function	ANSI	Description	03, 26D	04, 05A, 10, 10B, 10BE, 15, 26
MK11	F109 (F81 & F82)	Entrance/Office	\$137.00	\$147.00
MK12	F86	Storeroom	\$137.00	\$147.00
MK13	F82	Exterior	\$137.00	\$147.00
MK14	F92	Service Station	\$155.00	\$165.00
MK15¹	F93	Hotel	\$215.00	\$225.00
MK17	F84	Classroom	\$155.00	\$165.00
MK18	F113	Communicating Classroom	\$137.00	\$142.00

**Double Cylinder Functions**

Function	ANSI	Description	03, 26D	04, 05A, 10, 10B, 10BE, 15, 26
MK31	F80	Communicating	\$234.00	\$244.00
MK32	F88	Public Entrance	\$234.00	\$244.00
MK33	F87	Asylum	\$234.00	\$244.00
MK34	-	Exterior	\$234.00	\$244.00

Prices include IC option, ANSI strike, and UL latch.	
03, 26D	04, 05A, 10, 10B, 10BE, 15, 26
\$205.27	\$215.27
\$205.27	\$215.27
\$205.27	\$215.27
\$223.27	\$233.27
-	-
\$223.27	\$233.27
\$205.27	\$210.27
03, 26D	04, 05A, 10, 10B, 10BE, 15, 26
\$302.27	\$312.27
\$302.27	\$312.27
\$302.27	\$312.27
\$302.27	\$312.27

¹ Not available with IC option.

Strike Options	Description	Specify	Price Add
T-Strike	1-1/8" x 2-3/4", 1-1/4" lip, square corner, no box	300	Standard
ANSI <sup>1</sup>	1-1/4" x 4-7/8", 1-1/4" lip, square corner, no box	306 <sup>1</sup>	\$20.69
Full Lip D-Type	1-3/4" x 2-1/4", 1-1/4" lip, square corner	302	No Add
Radius D-Type	1-3/4" x 2-1/4", 1-1/4" lip, 1/4" radius corner	303	No Add
Box Strike	Supplied when specified	WBS	No Add

Latch Options	Description	Spring Latch	Dead Latch	Price Add
2-3/4" Backset	1-1/8", square corner	104	114	Standard
	1-1/8", square corner, UL <sup>1</sup>	224 <sup>1</sup>	124 <sup>1</sup>	\$22.58
	1", square corner	102	112	\$4.96
	1", square corner, UL	222	122	\$22.58
	Drive-in	-	116	\$7.45
2-3/8" Backset	1", square corner	101	111	No Add
	1", square corner, UL	221	121	\$22.58
	1", round corner	109	-	\$4.96
	Drive-in	-	115	\$7.45
Less Latch		LAT	--\$4.45	

Keying & Cylinder Options	Specify	Price Add
Keyed alike in four (quantity permitting otherwise KD)	KA4	Standard
Keyed different	KD	No Add
Master keyed	MK	\$14.75 per cylinder
Construction master keyed	CMK	\$9.30 per cylinder
Master keyed & construction master keyed	MK-CMK	\$24.05 per cylinder
O-Bitted	OB	No Add
Less Cylinder	LC	--\$9.70
TA design prepared to accept 6 or 7-pin SFIC cylinder, less core	IC <sup>1</sup>	\$25.00

<sup>1</sup> Unless otherwise specified, locksets requesting "IC" option will be provided with an ANSI strike and UL latch at additional costs shown above.

Strikes	Description	Strike No.	Price
T-Strike	1-1/8" x 2-3/4", 1-1/4" lip, square corner	300	\$9.61
ANSI	1-1/4" x 4-7/8", 1-1/4" lip, square corner	306	\$30.30
Full Lip D-Type	1-3/4" x 2-1/4", 1-1/4" lip, square corner	302	\$9.61
Radius D-Type	1-3/4" x 2-1/4", 1-1/4" lip, 1/4" radius corner	303	\$9.61
Box Strike	Used with 306 ANSI strike	BX70	\$5.76
Box Strike	Used with 300, 302, or 303 strike	BX10	\$5.76

Latches	Description	Spring Latch	Dead Latch	Price
2-3/4" Backset	1-1/8", square corner	104	114	\$13.37
	1-1/8", square corner, UL	224	124	\$35.95
	1", square corner	102	112	\$18.33
	1", square corner, UL	222	122	\$35.95
	Drive-in	-	116	\$20.82
2-3/8" Backset	1", square corner	101	111	\$13.37
	1", square corner, UL	221	121	\$35.95
	1", round corner	109	-	\$18.33
	Drive-in	-	115	\$20.82

Cylinder & Related	Part No.	Price
Standard cylinder (except for B knob) (drilled 6, pinned 5)	100C	\$29.15
Standard cylinder for B knob (drilled 6, pinned 5)	100C-750	\$29.15
Alternate cylinder (except for B knob) (drilled 6, pinned 6)	300C	\$29.15
Alternate cylinder for B knob (drilled 6, pinned 6)	300C-750	\$29.15
Hotel cylinder (except for B knob)	H100C	\$45.35
Hotel cylinder for B knob	H100C-750	\$45.35
Standard keyblank	K5A	\$1.46
Standard tailpiece (except for B knob or hotel function)	550AM-44	\$2.95
Standard tailpiece for B knob (except hotel function)	750-44	\$2.95
Hotel function tailpiece (except for B knob)	550H-44	\$2.95
Hotel function tailpiece for B knob	750H-44	\$2.95
IC core cylinder - See Keys & Cylinders section	-	-
IC core tailpiece pack for 6- & 7-pin cores	550CR-44-201	\$5.70

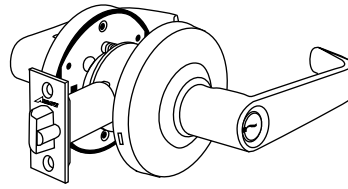

# MLX Series

### Features

Certification	BHMA A156.2, Series 4000, Grade 2, UL Listed
Freewheeling Lever Action	Standard
Door Thickness	Fits 1-3/8" to 1-3/4", factory set for 1-3/4"
Strike	ANSI 1-1/4" x 4-7/8"
Latch	2-3/4" backset, 1-1/8" front
Cylinder	Standard: 6 Pin, solid brass, 2 nickel-plated brass keys; IC prep available
Handing	Non-handed
Case Quantity	6 per case
Average Case Weight	27 lbs.
Warranty	10 years

Available Finishes	Arrow Code	BHMA Code	U.S. Code
Bright Brass	03	605	US3
Dark Oxide Satin Bronze, equivalent	613E	613E	US10BE
Satin Chromium Plated	26D	626	US26D
Black Suede Powder Coated <sup>1</sup>	BSP	-	-

### How to Order

Function & Trim	<b>MLX81-SB</b>
Finish	<b>MLX81-SB-26D</b>
Strike	<b>MLX81-SB-26D-306</b>
Latch	<b>MLX81-SB-26D-306-R21</b>
Keying	<b>MLX81-SB-26D-306-R21-ARKD</b>

Function	Description	03, 613E, 26D, BSP <sup>1</sup>
MLX01-SB	Passage	\$140.00
MLX08-SB	Single Dummy	\$57.00
MLX72-SB	Privacy	\$151.00
MLX81-SB	Entrance/Office	\$165.00
MLX82-SB	Storeroom	\$165.00
MLX87-SB	Classroom	\$165.00
MLX93-SB (26D finish only)	Asylum	\$207.00

\*\*\* AVAILABLE THROUGH SELECT DISTRIBUTORS – CONTACT ARROW LOCK FOR MORE INFORMATION \*\*\*

Rigid Lever Function	Description	03, 613E, 26D, BSP
MLX02-SB	Privacy	\$151.00
MLX11-SB	Entrance	\$165.00
MLX12-SB	Storeroom	\$165.00
MLX17-SB	Classroom	\$165.00
MLX33-SB	Asylum	\$207.00

Specify SR trim for MLX design with removable thru-bolts.

<sup>1</sup> Available through select distributors. Contact Arrow Lock for more information.



**ASSA ABLOY**

February 1, 2022

## MLX Series Options & Parts

Keying & Cylinder Options	Specify	Price Add
Keyed different, AR keyway	ARKD	Standard
Keyed different, CS keyway	CSKD	No Add
Lock prepared to accept a 6- or 7-pin SFIC cylinder (not included)	IC	No Add
Lock prepared to accept Schlage LFIC cylinder (not included)	SIC <sup>1</sup>	\$25.00

<sup>1</sup> Not available with 10BP or 03 finishes.

Strike & Latch Options	Spring Latch	Dead Latch	Price Add
2-3/4" backset x 1-1/8" front	R23	R21	Standard

Parts	Part No.	Price
Standard cylinder with tailpiece – AR keyway	C700HD	\$29.15
Standard cylinder with tailpiece – CS keyway	C700HD-CS	\$29.15
Strike	306	\$30.30
Latch - 2-3/4" backset	R23 <sup>1</sup> or R21 <sup>2</sup>	\$17.68
Screw pack	QL-201	\$2.14
Standard cylinder tailpiece	1001SC-44	\$2.95
Standard cylinder screw cap	SC-01	\$9.61
Standard cylinder cap pin	SC-02	\$3.47
Standard cylinder cap spring	SC-03	\$1.08
IC tailpiece kit (tailpiece & spacer for 6- & 7- pin cores)	RLX-44-201	\$5.70
Alternate latch – 2-3/8" backset x 1" front (sold only as a separate part)	R22 <sup>1</sup> or R20 <sup>2</sup>	\$17.68

<sup>1</sup> Used only with non-keyed functions.

<sup>2</sup> Used only with keyed functions.

Cylindrical Locks

# RK Series

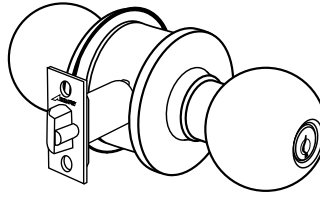

## Features

Certification	BHMA A156.2, Series 4000, Grade 2, UL Listed
Door Thickness	Fits 1-3/8" - 1-3/4", factory set for 1-3/4"
Strike	Standard: T-strike, 1-1/8" x 2-3/4"; alternate strikes available
Latch	Standard: 2-3/8" backset, 1" front; alternate latches available
Cylinder	Standard: 6-pin, solid brass, 2 brass keys; IC prep available
Handing	Non-handed
Case Quantity	10
Average Case Weight	13 lbs.
Warranty	5 years

Available Finishes	Arrow Code	BHMA Code	U.S. Code
Bright Brass	03	605	US3
Satin Brass	04	606	US4
Dark Oxidized Satin Bronze, Oil Rubbed	10B	613	US10B
Polished Stainless Steel	32	629	US32
Satin Stainless Steel	32D	630	US32D
Dark Oxide Satin Bronze, Equivalent <sup>1</sup>	613E	613E	US10BE

## How to Order

Function & Trim	RK11-BD
Finish	RK11-BD-32D
Strike	RK11-BD-32D-R60
Latch	RK11-BD-32D-R60-R70
Keying	RK11-BD-32D-R60-R70-KD-AR

Function	ANSI	Description	03, 32D	04, 10B, 32, 613E <sup>1</sup>
RK01	F75	Passage	\$56.00	\$66.00
RK02	F76A	Privacy	\$57.00	\$67.00
RK08	—	Single Dummy	\$29.00	\$34.00
RK11	F109	Entrance	\$62.00	\$72.00
RK12	F86	Storeroom	\$62.00	\$72.00
RK17	F84	Classroom	\$62.00	\$72.00

<sup>1</sup> Available through select distributors. Contact Arrow Lock for more information.

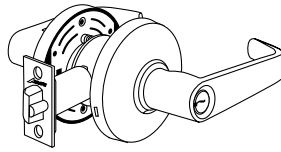

SR Trim

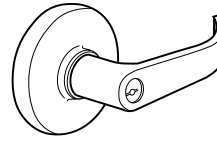

BRR Trim

# RL Series

### Features

Certification	BHMA A156.2, Series 4000, Grade 2, UL Listed
Door Thickness	Fits 1-3/8" - 1-3/4", factory set for 1-3/4"
Strike	Standard: ANSI 1-1/4" x 4-7/8"; alternate strikes available
Latch	Standard: 2-3/4" backset, 1-1/8" front; alternate latches available
Cylinder	Standard: 6-pin, solid brass, 2 brass keys; IC prep available
Handing	Non-handed
Case Quantity	10
Average Case Weight	38 lbs.
Warranty	5 years

Available Finishes	Arrow Code	BHMA Code	U.S. Code
Bright Brass	03	605	US3
Satin Brass	04	606	US4
Dark Oxidized Satin Bronze, Oil Rubbed	10B	613	US10B
Bright Chromium Plated	26	625	US26
Satin Chromium Plated	26D	626	US26D
Dark Oxide Satin Bronze, Equivalent <sup>1</sup>	613E	613E	US10BE
Black Suede Powder Coated <sup>1</sup>	BSP	—	—

### How to Order

Function	<b>RL11</b>
Trim	<b>RL11-SR</b>
Finish	<b>RL11-SR-26D</b>
Strike	<b>RL11-SR-26D-R62</b>
Latch	<b>RL11-SR-26D-R62-R71</b>
Keying	<b>RL11-SR-26D-R62-R71-KD-AR</b>

Function	ANSI	Description	03, 26D, 613E <sup>1</sup> , BSP <sup>1</sup>	04, 10B, 26
RL01	F75	Passage	\$104.00	\$114.00
RL02	F76A	Privacy	\$107.00	\$117.00
RL03	—	Communicating	\$107.00	\$112.00
RL08	—	Single Dummy	\$48.00	\$53.00
RL11	F109	Entrance	\$125.00	\$135.00
RL12	F86	Storeroom	\$125.00	\$135.00
RL17	F84	Classroom	\$125.00	\$135.00

<sup>1</sup> Available through select distributors. Contact Arrow Lock for more information.

# RK & RL Series

## Options & Parts

Strike Options	Description	Specify	Price Add
T-Strike	1-1/8" x 2-3/4", 1-1/4" lip, square corner – standard with RK Series	R60	No Add
Square Corner	1-3/4" x 2-1/4", 1-1/4" lip, square corner – full lip	R61	No Add
ANSI	1-1/4" x 4-7/8", 1-1/4" lip, square corner – standard with RL Series	R62	No Add

Latch Options	Description	Spring Latch	Dead Latch	Price Add
2-3/8" Backset	1", square corner – standard with RK Series	R72	R70	No Add
2-3/4" Backset	1-1/8", square corner – standard with RL Series	R73	R71	No Add

Keying & Cylinder Options	Specify	Price Add
Keyed different, AR Keyway	ARKD	Standard
Keyed different, CS Keyway	CSKD	No Add
Master Keyed	MK	\$14.75 per cylinder
Construction Master Keyed	CMK	\$9.30 per cylinder
Master Keyed & Construction Master Keyed	MK-CMK	\$24.05 per cylinder
Keyed Alike	KA	No Add
O-bitted	OB	No Add
Less Cylinder	LC	--\$9.70
Lock prepared to accept 6 or 7-pin SFIC Cylinder, less core	IC	No Add

### Parts

Strikes	Description	Part No.	Price
T-Strike	1-1/8" x 2-3/4", 1-1/4" lip, square corner	R60	\$9.01
Square Corner	1-3/4" x 2-1/4", 1-1/4" lip, square corner	R61	\$9.01
ANSI	1-1/4" x 4-7/8", 1-1/4" lip, square corner	R62	\$30.30

Latches	Description	Spring Latch	Dead Latch	Price
2-3/8" Backset	1", square corner	R72	R70	\$18.33
	Drive-in <sup>1</sup>	R76	R74	\$18.33
2-3/4" Backset	1-1/8", square corner	R73	R71	\$18.33
	Drive-in <sup>1</sup>	R77	R75	\$18.33

Cylinders & Related	Part No.	Price	
Standard cylinder	100C-RK	\$29.15	
RK Series	Standard keyblank	K5A	\$1.46
	Standard tailpiece	550RK-44	\$2.95
	IC tailpiece pack for 6- & 7-pin cores	100CR-44-201	\$5.70
	Standard cylinder	600HD	\$29.15
RL Series	Standard keyblank	K6A	\$1.46
	Standard tailpiece	1001-44	\$2.95
	6-Pin IC core tailpiece	HSCR6-44	\$3.52
	7-Pin IC core tailpiece	HSCR7-44	\$3.52

<sup>1</sup> Sold only as a separate part; specify 26D or 03 finish.



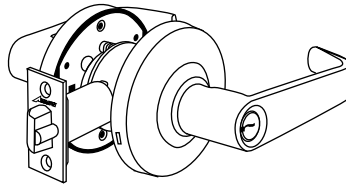

# RLX Series

### Features

Certification	BHMA A156.2, Series 4000, Grade 2, UL Listed
Freewheeling Lever Action	Standard
Door Thickness	Fits 1-3/8" to 1-3/4", factory set for 1-3/4"
Strike	ANSI 1-1/4" x 4-7/8"
Latch	2-3/4" backset, 1-1/8" front
Cylinder	Standard: 6-pin, solid brass, 2 nickel-plated brass keys; IC prep available
Handing	Non-handed
Case Quantity	6 per case
Average Case Weight	26 lbs.
Warranty	10 years

Available Finishes	Arrow Code	BHMA Code	U.S. Code
Bright Brass	03	605	US3
Dark Oxide Satin Bronze, equivalent	613E	613E	US10BE
Satin Chromium Plated	26D	626	US26D
Black Suede Powder Coated	BSP	-	-

### How to Order

Function & Trim	<b>RLX81-SR</b>
Finish	<b>RLX81-SR-26D</b>
Strike	<b>RLX81-SR-26D-306</b>
Latch	<b>RLX81-SR-26D-306-R21</b>
Keying	<b>RLX81-SR-26D-306-R21-ARKD</b>

*** AVAILABLE THROUGH SELECT DISTRIBUTORS – CONTACT ARROW LOCK FOR MORE INFORMATION ***			
Function	Description	03, 26D	613E, BSP
RLX01-SR	Passage	\$118.00	\$131.00
RLX08-SR	Single Dummy	\$46.00	\$52.00
RLX72-SR	Privacy	\$123.00	\$137.00
RLX81-SR	Entrance/Office	\$143.00	\$156.00
RLX82-SR	Storeroom	\$143.00	\$156.00
RLX87-SR	Classroom	\$143.00	\$156.00

# RLX Series

## Options & Parts

Strike Option	Specify	Price Add
ANSI	306	Standard

Latch Options	Spring Latch	Dead Latch	Price Add
2-3/4" backset x 1-1/8" front	R23	R21	Standard

Keying & Cylinder Options	Specify	Price Add
Keyed different, AR keyway	ARKD	Standard
Keyed different, CS keyway	CSKD	No add
Lock prepared to accept a 6- or 7-pin SFIC cylinder (not included)	IC	No add

Parts	Part No.	Price
Standard cylinder with tailpiece – AR keyway	C700HD	\$29.15
Standard cylinder with tailpiece – CS keyway	C700HD-CS	\$29.15
Strike	306	\$30.30
Latch - 2-3/4" backset	R23 <sup>1</sup> or R21 <sup>2</sup>	\$17.68
Latch - 2-3/8" backset latch x 1" front (sold only as separate part)	R22 <sup>1</sup> or R20 <sup>2</sup>	\$17.68
Screw pack for latch & strike	RLX-201	\$2.14
Screw pack for chassis, rose, & thru-bolts	RLX-201A	\$2.14
Standard cylinder tailpiece	1001SC-44	\$2.95
Standard cylinder screw cap	SC-01	\$9.61
Standard cylinder cap pin	SC-02	\$3.47
Standard cylinder cap spring	SC-03	\$1.08
IC tailpiece kit (tailpiece & spacer for 6- & 7-pin cores)	RLX-44-201	\$5.70

<sup>1</sup>Used only with non-keyed functions

<sup>2</sup>Used only with keyed functions

# DBX Series

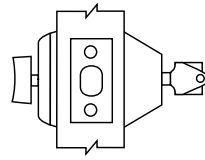

DBX61

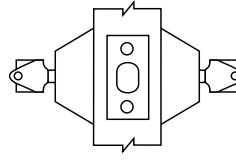

DBX62

### Features

Certification	BHMA A156.36 Auxiliary Locks, Grade 2, UL Listed
Door Thickness	Fits 1-3/8" - 1-3/4", factory set for 1-3/4"
Strike	2-3/4" x 1-1/8", square corners
Latch	2-3/8" - 2-3/4", adjustable backset, 1" front, includes spacer for 1-1/8" door prep
Cylinder	6-pin, solid brass, keyed alike in 4, CS keyway includes 2 brass keys
Handing	Non-handed
Case Quantity	12
Average Case Weight	DBX61 - 18lbs. / DBX62 - 22lbs.
Warranty	1 year

Available Finishes	Arrow Code	BHMA Code	U.S. Code
Bright Brass	605	605	US3
Dark Oxidized Satin Bronze, equivalent	613E	613E	US10BE
Satin Stainless Steel	630	630	US32D

### How to Order

Function	<b>DBX61</b>
Finish	<b>DBX61-630</b>
Keying	<b>DBX61-630-CS-KA4</b>

Function	Description	630	605, 613E
DBX61	Cylinder x Thumbturn	\$50.00	\$59.00
DBX62	Cylinder x Cylinder	\$71.00	\$79.00

# DBX Series

## Options & Parts

### Options

Strike Option	Specify	Price Add
2-3/4" x 1-1/8", square corners	394	Standard

Latch Option	Specify	Price Add
2-3/8" - 2-3/4", adjustable backset	L14	Standard

Keying & Cylinder Options	Specify	Price Add
CS keyway, keyed alike in 4	CS-KA4	Standard
AR keyway, keyed alike in 4	AR-KA4	No Add
Lock prepared to accept a 6- or 7-pin SFIC cylinder (not included)	IC	\$20.00

### Parts

Parts	Part No.	Price Add
Cylinder for DBX61 x CS keyway, keyed different	96C-CS-DBX	\$22.65
Cylinder for DBX61 x AR keyway, keyed different	96C-DBX	\$22.65
Cylinder for DBX62 x CS keyway, keyed different	96DC-CS-DBX	\$22.65
Cylinder for DBX62 x AR keyway, keyed different	96DC-DBX	\$22.65
Strike	DBX-394	\$7.46
Standard bolt	DBX-L14	\$16.18
Optional drive in bolt (sold only as a separate part)	DBX-L18	\$16.18
Screw pack for DBX61	DBX61-201	\$9.61
Screw pack for DBX62	DBX62-201	\$9.61
Thick door pack for DBX61, up to 2" thick doors	DBX61-TDP	\$9.61
Thick door pack for DBX62, up to 2" thick doors	DBX62-TDP	\$9.61

## D Series

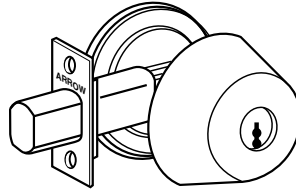

### Features

Certification	BHMA A156.5, Grade 1, UL Listed
Door Thickness	Fits 1-3/8" - 1-3/4", factory set for 1-3/4"
Strike	Standard: 1-1/8" x 2-1/4"; alternate strikes available
Latch	Standard: 2-3/4" backset, 1-1/8" front; alternate bolts available
Cylinder	Standard: 6-pin, solid brass, 2 nickel-silver keys; IC prep available
Handing	Non-handed
Case Quantity	12
Average Case Weight	22 lbs.
Warranty	1 year

Available Finishes	Arrow Code	BHMA Code	U.S. Code
Bright Brass	03	605	US3
Satin Brass	04	606	US4
Black Suede Powder	BSP	-	-
Antique Brass	05A	609	US5
Satin Bronze	10	612	US10
Dark Oxidized Satin Bronze, Oil Rubbed	10B	613	US10B
Dark Oxidized Satin Bronze, equivalent	10BE	613E	US10BE
Bright Chromium Plated	26	625	US26
Satin Chromium Plated	26D	626	US26D

### How to Order

Function	<b>D61</b>
Finish	<b>D61-26D</b>
Strike	<b>D61-26D-346</b>
Latch	<b>D61-26D-346-144</b>
Keying	<b>D61-26D-346-144-KD-AR</b>

Function	ANSI	Description	03, 26D	04, 05A, 10, 10B, 10BE, 26, BSP
D60	E01111	Thumbturn x Blank Plate	\$107.00	\$117.00
D61	E0151	Cylinder x Thumbturn	\$123.00	\$133.00
D62	E0141	Double Cylinder	\$160.00	\$170.00
D63	E0161	Cylinder x Blank Plate	\$129.00	\$139.00
D64	E0171	Cylinder x Thumbturn (classroom)	\$129.00	\$139.00
D71-IC <sup>1</sup>	E0151	Cylinder x Thumbturn	\$191.00	\$201.00
D73-IC <sup>1</sup>	E0161	Cylinder x Blank Plate	\$191.00	\$201.00
D74-IC <sup>1</sup>	E0171	Cylinder x Thumbturn (classroom)	\$191.00	\$201.00

<sup>1</sup>Concealed mounting screws standard on D71 & D73 functions. IC price add required. See Options page.

# E Series

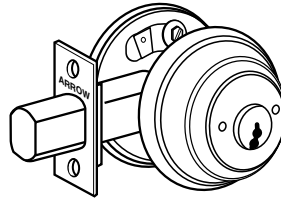
**ASSA ABLOY**

### Features

Certification	BHMA A156.5, Grade 2, UL Listed
Door Thickness	Fits 1-3/8" - 1-3/4", factory set for 1-3/4"
Strike	Standard: 1-1/8" x 2-1/4"; alternate strikes available
Latch	Standard: 2-3/8" backset, 1-1/8" front; alternate bolts available
Cylinder	Standard: 6-pin, keyed 5, solid brass, 2 brass keys; IC prep available
Handing	Non-handed
Case Quantity	12
Average Case Weight	E61 - 20 lbs. / E62 - 25 lbs.
Warranty	1 year

Available Finishes	Arrow Code	BHMA Code	U.S. Code
Bright Brass	03	605	US3
Satin Brass	04	606	US4
Black Suede Powder	BSP	-	-
Antique Brass	05A	609	US5
Satin Bronze	10	612	US10
Dark Oxidized Satin Bronze, Oil Rubbed	10B	613	US10B
Dark Oxidized Satin Bronze, equivalent	10BE	613E	US10BE
Satin Nickel	15	619	US15
Bright Chromium Plated	26	625	US26
Satin Chromium Plated	26D	626	US26D

### How to Order

Function	<b>E61</b>
Finish	<b>E61-26D</b>
Strike	<b>E61-26D-346</b>
Latch	<b>E61-26D-346-141</b>
Keying	<b>E61-26D-346-141-KD-AR</b>

Function	ANSI	Description	03, 26D	04, 05A, 10, 10B, 10BE, 15, 26, BSP
E50	-	Occupancy Indicator	\$66.00	\$76.00
E60	E01112	Thumbturn x Blank Plate	\$58.00	\$68.00
E61	E0152	Cylinder x Thumbturn	\$70.00	\$80.00
E62	E0142	Double Cylinder	\$87.00	\$97.00
E63	E0162	Cylinder x Blank Plate	\$78.00	\$88.00
E64	E0172	Cylinder x Thumbturn (classroom)	\$78.00	\$88.00
E71-IC <sup>1</sup>	E0152	Cylinder x Thumbturn	\$95.00	\$105.00
E74-IC <sup>1</sup>	E0172	Cylinder x Thumbturn (classroom)	\$103.00	\$113.00
E41 Low Profile <sup>2</sup>	-	Cylinder x Thumbturn	\$66.00	\$76.00
E42 Low Profile <sup>2</sup>	-	Double Cylinder	\$84.00	\$94.00

<sup>1</sup> Furnished with concealed mounting screws. IC price add required. See Options page.

<sup>2</sup> Only available in 03, 26D, and 15 finishes. Supplied with 5-pin cylinder.



345



346

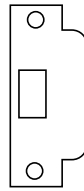

347

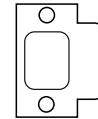

350

## D & E Series Options

Strike Options	Description	Specify	Price Add
Square Corner	345 & 346 strikes	395	Standard
Square Corner	1-1/8" x 2-3/4", for wood jambs (4 mounting holes)	345	No Add
Square Corner	1-1/8" x 2-3/4", for metal jambs (2 mounting holes)	346	No Add
ANSI	1-1/4" x 4-7/8", 1-1/4" lip, square corner	347	No Add
T-Strike	1-1/8" x 2-3/4", 1-1/4" lip, square corner	350	No Add

Bolt Options	Description	Dead Latch	Price Add
2-3/4" Backset	1-1/8", square corner	144	Standard (D Series)
2-3/8" Backset	1", square corner	141	Standard (E Series)
2-3/4" Backset	1", square corner	142	No Add
2-3/8" Backset	Drive-in	145	No Add
2-3/4" Backset	Drive-in	146	No Add
2-3/8" & 2-3/4" Backsets for E50	Includes 141 & 144 latches	149	\$6.90
2-3/8" & 2-3/4" Backsets for E50	Includes 145 & 146 latches	148	\$6.90
Less Latch		LAT	-\$6.90

Keying & Cylinder Options	Specify	Price Add
Keyed different	KD	Standard (D Series)
Keyed alike in four (quantity permitting)	KA4	Standard (E Series)
Master keyed <sup>1</sup>	MK	\$14.75 per cylinder
Construction master keyed <sup>1</sup>	CMK	\$9.30 per cylinder
Master keyed & construction master keyed <sup>1</sup>	MK-CMK	\$24.05 per cylinder
O-Bitted <sup>1</sup>	OB	No Add
Less Cylinder <sup>1</sup>	LC	-\$9.70
Lock prepared to accept 6 or 7-pin IC cylinder, less core	IC	\$25.00

<sup>1</sup> Not available with E41 or E42 function.

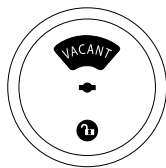

Exterior

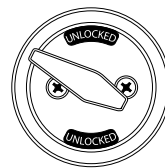
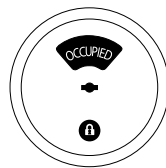

Interior

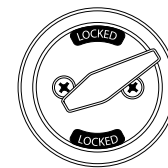

Visual Indicator Option	Exterior Display	Interior Display	Colors	Price Add	
E61	V01	No Indicator	Unlocked/Locked	Red/Green	\$30.00
	V04	No Indicator	Unlocked/Locked	Red/White	\$30.00
E50	Standard	Vacant/Occupied	Unlocked/Locked	Red/Green	No Add
	V54	Vacant/Occupied	Unlocked/Locked	Red/White	No Add

Strikes	Description	Part No.	Price
Square Corner	1-1/8" x 2-3/4", for metal jambs (4 mounting holes)	345	\$9.61
Square Corner	1-1/8" x 2-3/4", for wood jambs (2 mounting holes)	346	\$9.61
ANSI	1-1/4" x 4-7/8"	347	\$18.98
T-Strike	1-1/8" x 2-3/4", 1-1/4" lip	350	\$9.61
Box strike for E Series		BX91	\$3.10
Box strike for D Series		BX91D	\$3.10

Bolts	Description	Part No.	Price
2-3/4"	1-1/8", square corner	144	\$20.82
2-3/8"	1", square corner	141	\$20.82
2-3/4"	1", square corner	142	\$20.82
2-3/8"	Drive-in	145	\$20.82
2-3/4"	Drive-in	146	\$20.82

Cylinder by Function	Part No.	Price
E41	100	\$29.15
E42	100DC	\$29.15
E61, E63, E64	96C <sup>1</sup>	\$29.15
E62	96DC	\$29.15
D61, D63, D64	692C	\$29.15
D62	692DC	\$29.15

Tailpiece by Function	Part No.	Price
E42	D62CR-44	\$2.95
E42, E62, D62	D62-44	\$2.95
E50 Without Indicator or With Single Indicator	E50-44	\$2.95
E50 x Double Visual Indicator	E50-1-44	\$2.95
E60, D60	E60-44	\$2.95
E61, D61	D61-44	\$2.95
E62, D62	D62-44-13/8	\$2.95

Screw Pack by Function	Part No.	Price
E50 Without Indicator or With Single Indicator	E50-201	\$9.61
E50 x Double Visual Indicator	E50-1-201	\$9.61
E60	E60-201	\$9.61
E61	E61-201	\$9.61
E61 x Visual Indicator	D61-201	\$9.61
E62, D62	DE62-201	\$9.61
D60	D60-201	\$9.61
D61	D61-201	\$9.61

Miscellaneous Parts	Part No.	Price
E61 Thick door pack, up to 2-1/4"	E61-TDP	\$9.61
E62, D62 Thick door pack, up to 2-1/4"	E62-TDP	\$9.61
D61 Thick door pack, up to 2-1/4"	D61-TDP	\$9.61
E50 Emergency key	EMER-INDICATOR.KEY	\$9.61
Cam assembly for 6 & 7-pin IC cylinders	D61CR-121A	\$5.70

<sup>1</sup> Can be used with E41 on 1-3/4" thick doors.

Experience a safer  
and more open world



# N Series

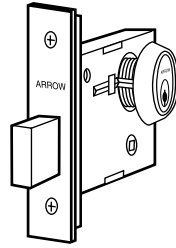

## Features

Certification	UL Listed
Door Thickness	Fits 1-3/8" - 1-3/4"
Strike	Standard: 1-1/8" x 3-1/2"; alternate strikes available
Bolt	1" throw with hardened pin
Backset	2-3/4"
Cylinder	Standard: 6-pin, solid brass, 2 nickel-silver keys; IC prep available
Handing	Non-handed
Case Quantity	20
Average Case Weight	38 lbs.
Warranty	1 year

Available Finishes	Arrow Code	BHMA Code	U.S. Code
Bright Brass	03	605	US3
Satin Brass	04	606	US4
Satin Bronze	10	612	US10
Dark Oxidized Satin Bronze, Oil Rubbed	10B	613	US10B
Dark Oxidized Satin Bronze, equivalent	10BE	613E	US10BE
Bright Chromium Plated	26	625	US26
Satin Chromium Plated	26D	626	US26D

## How to Order

Function	<b>N41</b>
Finish	<b>N41-26D</b>
Strike	<b>N41-26D-380</b>
Keying	<b>N41-26D-380-KD-AR</b>

Function	ANSI	Description	26D	03, 04, 10, 10B, 10BE, 26
N40	-	Thumbturn One Side	\$235.00	\$242.00
N41	E06071	Cylinder x Thumbturn	\$269.00	\$276.00
N42	E06061	Double Cylinder	\$280.00	\$287.00
N43	E06081	Cylinder One Side	\$245.00	\$252.00
N44	E06091	Cylinder x Thumbturn (classroom)	\$274.00	\$281.00

## N Series Options & Parts



380

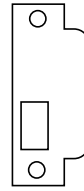

356

Strike Options	Description	Specify	Price Add
Square Corner	1-1/8" x 3-1/2"	380	Standard
ANSI	1-1/4" x 4-7/8"	356	\$9.37

Keying & Cylinder Options	Specify	Price Add
Keyed different	KD	Standard
Master keyed	MK	\$14.75 per cylinder
Construction master keyed	CMK	\$9.30 per cylinder
Master keyed & construction master keyed	MK-CMK	\$24.05 per cylinder
O-Bitted	OB	No Add
Less Cylinder	LC	--\$15.10
Lock prepared to accept 6-pin SFIC cylinder, less core	IC6	No Add
Lock prepared to accept 7-pin SFIC cylinder, less core	IC7	No Add

Auxiliary Locks



836-17A

Parts	Part No.	Price
Standard mortise cylinder	MC61-004	\$45.35
Square corner strike, 1-1/8" x 3-1/2"	380	\$9.61
ANSI strike, 1-1/4" x 4-7/8"	356	\$9.37
Thumbturn	836-17A	\$26.05
Faceplate & screw pack	836-204	\$22.30
Lock body only	836K-LB	\$178.00

# Padlocks

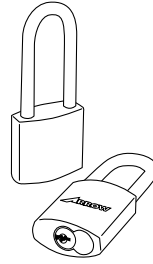

## SFIC Padlocks (cylinder not included)

Shackle	Part No.	Price
1"	EPC1-IC	\$80.00
2"	EPC2-IC	\$83.00
3"	EPC3-IC	\$84.00

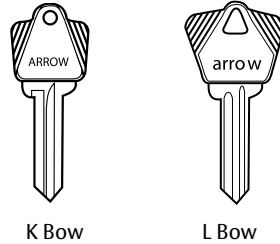

# Keys & Keying Charges

## Standard Cylinders

Key Blanks	Part No.	Price
Standard bow, 5-pin key blank, "A" keyway	K5A	\$1.46
Standard bow, 6-pin key blank, "A" keyway	K6A	\$1.46
Large bow, 6-pin key blank, "A" keyway	L6A	\$2.34
Sectional keyway, standard bow, 6-pin	K671 x (kwy <sup>1</sup> )	\$2.34
Sectional keyway, large bow, 6-pin	L671 x (kwy <sup>1</sup> )	\$2.34

<sup>1</sup> Consult factory for Arrow sectional keyways.

Cut Keys	Price
Extra cut keys	\$4.88 per key
Master or Grandmaster key	\$9.86
Construction master key	\$9.86

Keying Charges	Price
Master keyed	\$14.75 per cylinder
Construction master keyed	\$9.30 per cylinder
Keyed different	No Add
Keyed alike	No Add
0-Bitted	No Add

Key Stamping	Price
Stamping key with letters and/or numbers (limited to key space)	\$5.30 per side
Stamping key with <i>US Property Do Not Duplicate</i>	\$1.91 per side
Stamping non-IC key <sup>2</sup> with <i>Do Not Duplicate</i>	\$1.91 per side

Key Control for factory-master-keyed systems	Specify	Price
Stamping cylinder (visual) and 2 keys with standard keying symbols	VKC	\$5.30 per set
Stamping cylinder (concealed) and 2 keys with standard keying symbols	CKC	\$5.30 per set
Stamping each additional key with standard keying symbols		\$3.55 per key

<sup>2</sup> Coining on IC keys include: *Duplication Prohibited* or *It Is Unlawful To Duplicate This Key*.

Bitting list only or bitting list copy	Bitting List	\$105.00
<ul style="list-style-type: none"> <li>• Bitting lists are provided on disks. Systems not available on disk will be provided on paper.</li> <li>• Large key systems on paper will be priced on a case-by-case basis.</li> <li>• Copies of bitting lists may require prior factory approval.</li> </ul>		

# Cylinders

## Mortise & Rim



Mortise Cylinder

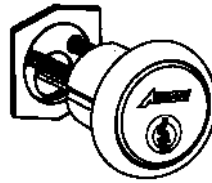

Rim Cylinder

Mortise Cylinders <sup>1</sup>	Part No.	Price
Standard 1-1/8" cylinder	MC61-(cam)	\$45.35
1-1/4" Cylinder	MC61-2-(cam)	\$45.35
1-1/2" Cylinder	MC61-3-(cam)	\$67.00
2" Cylinder	MC61-4-(cam)	\$67.00

<sup>1</sup> Standard 001 cam supplied unless otherwise specified.

Mortise Cylinder Parts	Part No.	Price
Cam for mortise lock functions 12, 17, 22, 23, 24, 27, 32 (I/S), 33, 37	001	\$3.93
Cam for mortise lock functions 11, 13, 19, 20, 21, 31, 32 (O/S), 34, 38, 40, 41, 42, 44	AM2	\$3.93
Cam for N series, panic device trims, alarms	004	\$3.93
Cam for Schlage locks	006	\$3.93
Cam for Adam Rite locks	AR18	\$3.93
Cylinder collar and spring	16-113A	\$10.48

Rim Cylinders	Part No.	Price
Standard 6-pin cylinder	RC62	\$45.35

Rim Cylinder Parts	Part No.	Price
Cam bar for RC62	16RC-44	\$2.95
Plug/cam bar retainer	16RC-103	\$1.40

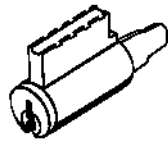
**ASSA ABLOY**

Cylindrical Lock Cylinder

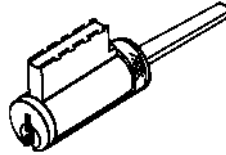

Deadbolt Cylinder

# Conventional Cylinders Cylindrical Locks & Deadbolts

Cylindrical Lock Cylinders	Part No.	Price
MK Series (except hotel function)	100C	\$29.15
MK Series hotel function	H100C	\$45.35
Cylinder kit (D/B style cyl w/3 D/B cambars, 3 KIK/KIL tail pcs, D/B washer)	K100C	\$34.35

Tailpiece Application	Part No.	Price
Q, W, H, S, ML, L & RL Series (except hotel function)	1001-44	\$2.95
Q, W, H, & ML Series hotel function	1001H-44	\$2.95
MK Series with TA or DD trim (except hotel function)	550AM-44	\$2.95
MK Series with BD trim (except hotel function), and RK Series	750-44	\$2.95
MK Series hotel function with TA or DD trim	550H-44	\$2.95
MK Series hotel function with BD trim	750H-44	\$2.95

Deadbolt Cylinders	Part No.	Price
E Series single cylinder	96C	\$29.15
E Series double cylinder	96DC	\$29.15
D Series single cylinder	692C	\$29.15
D Series double cylinder	692DC	\$29.15

Tailpiece Application	Part No.	Price
D & E Series single cylinder, 1-3/8" to 1-3/4" thick door	D61-44	\$2.95
D & E Series double cylinder, 1-3/4" thick door	D62-44	\$2.95
D & E Series double cylinder, 1-3/8" thick door	D62-44-13/8	\$2.95

Available Keyways	Arrow Equivalent
Arrow A	AR
Schlage C	CS

## IC Housings

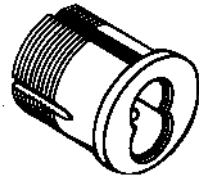

Mortise IC Housing

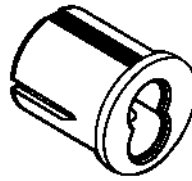

Rim IC Housing

Mortise Housings <sup>1</sup>		Part No.	Price
6-pin housings, 1-1/8"	Standard	16CR-16X (cam)	\$44.45
	Tapered	16CRT-16XAR18	\$46.15
7-pin housings, 1-1/4"	Standard	16CR-27X (cam)	\$44.45
	Tapered	16CRT-27XAR18	\$46.15

<sup>1</sup> Standard 16CR-001 cam supplied unless otherwise specified.

Mortise Housing Parts	Part No.	Price
Cam for mortise lock functions 12, 17, 22, 23, 24, 27, 32 (I/S), 33, 37	16CR-001	\$3.93
Cam for mortise lock functions 11, 13, 19, 20, 21, 31, 32 (O/S), 34, 38, 40, 41, 42, 44	16CR-AM2	\$3.93
Cam for N series, panic device trims, alarms	16CR-004	\$3.93
Cam for Schlage locks	16CR-006	\$3.93
Cam for Adams Rite locks	16CR-AR18	\$3.93
1/8" Spacer ring	16CR-123-1	\$15.27
1/4" Spacer ring	16CR-123-2	\$15.27
3/8" Spacer ring	16CR-123-3	\$15.27

Rim Housings	Part No.	Price
6-pin housing	16RCR-16	\$44.45
7-pin housing	16RCR-27	\$44.45

Rim Housing Parts	Part No.	Price
Cam bar	16RCR-44	\$2.95
Cam assembly (equal leg prongs)	16RCR-121A	\$9.61
Spring washer	16RCR-125	\$0.89
Yoke plate	961CR-117	\$1.09
Pan head screw (2 required)	4-40X1/4	\$0.50

• See *Plus Housings* section for Plus-related components.

# Pointe SFIC Cylinders



Barrel Caps

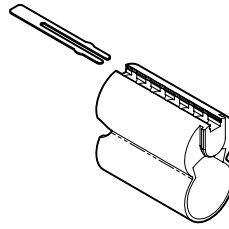

Slide Cover



IC Key Blank

SFIC Cylinders with Standard Barrel Caps		Part No.	04, 26D
6-pin core	Uncombined	100CR-UCX (kwy)	\$23.00
	Combined <sup>1</sup>	100CR- (kwy)	\$43.55
7-pin core	Uncombined	7100CR-UCX (kwy)	\$23.00
	Combined <sup>1</sup>	7100CR- (kwy)	\$43.55

SFIC Cylinders with Slide Cover		Part No.	04, 26D
6-pin core	Uncombined	100SR-UCX (kwy)	\$25.40
	Combined <sup>1</sup>	100SR- (kwy)	\$47.50
7-pin core	Uncombined	7100SR-UCX (kwy)	\$25.40
	Combined <sup>1</sup>	7100SR- (kwy)	\$47.50

<sup>1</sup> Includes 2 operating keys and keying charges.

Construction Cores & Components	Part No.	04, 26D
6-pin construction core	100CR.RED	\$43.55
7-pin construction core	7100CR.RED	\$43.55
Disposable SFIC plug adapter	13-5176	\$0.99
Construction master key		\$9.86
Construction control key		\$9.86

## Keys

For Keyways: 1C, 1D, AB, BB, CB, DB, EB, FB, GB, HB, JB, KB, LB, MB, QB, RB, TA, TB, TC, TD, TE	Part No.	Price
Key blank	C(kwy)	\$1.46
Operating key		\$4.88
Control key		\$9.86

For Keyways: WA, WB, WC, WG, WH, WY	Part No.	Price
Key blank	GB(kwy)	\$3.63
Operating key		\$10.93
Control key		\$10.93

Stamping Charges	Price
Stamping key with letters and/or numbers (limited to key space)	\$5.30 per side
Stamping key with <i>US Property Do Not Duplicate</i>	\$1.91 per side
Stamping cylinder with standard keying symbols (specify visual or concealed)	\$3.55

Stamping Charges for factory systems	Specify	Price
Stamping cylinder (visual) and 2 keys with standard keying symbols	VKC	No Add
Stamping cylinder (concealed) and 2 keys with standard keying symbols	CKC	No Add
Stamping each additional key with standard keying symbols		\$3.55 per key



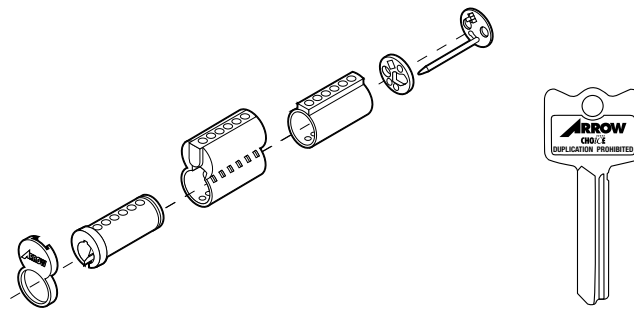

# Pointe Flex SFIC Cylinders Patented Product

Pointe Flex SFIC Cylinders & Keys <sup>1</sup>		Part No.	04, 26D
6-pin core	Uncombined	X1CR-UCX (kwy)	\$35.10
	Combined	X1CR-(kwy)	\$56.90
7-pin core	Uncombined	X71CR-UCX (kwy)	\$35.10
	Combined	X71CR-(kwy)	\$56.90
Standard Flex key blank		CH (kwy)	\$1.46
Flex key blank with hole in key blade		CHX (kwy)	\$4.88
Standard Flex operating key			\$5.97
Flex operating key with hole in key blade			\$9.86
Master, grandmaster, or control key			\$9.86

<sup>1</sup> See Pointe SFIC page for stamping charges.

- Contact factory for Flex keyway information.

Tailpieces & Components	Application	Part No.	Price
IC core tailpiece pack for 6- & 7-pin cores	RL Series 6-pin IC core tailpiece	HSCR6-44	\$3.52
	RL Series 7-pin IC core tailpiece	HSCR7-44	\$3.52
	MK Series	550CR-44-201	\$5.70
	RK Series	100CR-44-201	\$5.70
Tailpiece for use with Falcon...	6-pin core levers	X1CRF6-44	\$2.93
	7-pin core levers	X71CRF7-44	\$2.93
Tailpiece for use with Best...	6-pin core levers or knobs	X1CRB6-44	\$2.93
	7-pin core levers or knobs	X71CRB7-44	\$2.93
Tailpiece insert for cylindrical locks – 100-piece pack		X1CR-125PK	\$9.51

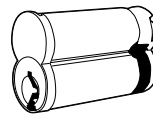

Sliding Door Lock	Part No.	04, 26D
7-Pin uncombined	SD7100CR-UCX (kwy)	\$51.90
7-Pin combined	SD7100CR- (kwy)	\$66.10

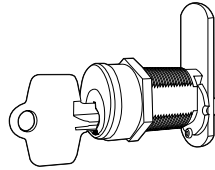

## Cam Locks

Cam Lock Kits	Part No.	Price
Sub-Assembled	CLK-10-(kwy <sup>1</sup> ).26D	\$65.90
Keyed different or keyed alike w/2 cut keys (not master-keyed)	CLK-11-(kwy <sup>1</sup> ).26D	\$83.40
Master-keyed w/2 cut keys	CLK-11M-(kwy <sup>1</sup> ).26D	\$97.80

<sup>1</sup> Available with standard Arrow IC keyways except for W and Flex.

Cam Lock Parts	Part No.	Price
Machined Plug	IKMPLG-(kwy).26D	\$13.50
Shell	IKSHELL2.26D	\$22.12
4-40 Screw	IKSCRPLT	\$1.08
Retainer	CP-021810	\$0.43
90° Stop	IKSTOP2	\$3.19
3/4" Hex Nut	IKHXNUT	\$0.40
Drive Pin	IKDRPIN	\$1.83
360° Drive Plate (NKR)	IKDRPLT	\$3.24
90° Drive Plate (KR)	IKDRPLT2	\$4.95
Cam, Straight	IKCAM2	\$3.57
Cam, Offset	IKCAM3	\$7.86
Pronged Washer	IKWSH1	\$0.90
Tumbler Spring	IKTSPRING <sup>2</sup>	\$5.95
Pin Hole Cover	IKPNCVR <sup>2</sup>	\$11.91

<sup>2</sup> Unit price shown. Sold in package quantities of 100.

Cam Lock Accessories	Part No.	Price
Spacer, 1/16"	IKSPCR1.26D	\$5.22
Spacer, 1/8"	IKSPCR3.26D	\$6.02
Spacer, 3/16"	IKSPCR4.26D	\$6.36
Spacer, 1/4" (provided with cam lock kit)	IKSPCR5.26D	\$6.51
Spacer, 5/16"	IKSPCR2.26D	\$6.58
Spacer, 3/8"	IKSPCR6.26D	\$7.35
Spacer, 7/16"	IKSPCR7.26D	\$7.70

# Plus IC Housings

Mortise Housings for Plus Cores <sup>1,2</sup>		Part No.	Price
6-pin housings, 1-1/8"	Standard	C16CR-16X (cam)	\$44.45
	Tapered	C16CRT-16XAR18	\$46.15
7-pin housings, 1-1/4"	Standard	C16CR-27X (cam)	\$44.45
	Tapered	C16CRT-27XAR18	\$46.15

Mortise Housing Parts	Part No.	Price
Cam for mortise lock functions 12, 17, 22, 23, 24, 27, 32 (I/S), 33, 37	001	\$3.93
Cam for mortise lock functions 11, 13, 19, 20, 21, 31, 32 (O/S), 34, 38, 40, 41, 42, 44	AM2	\$3.93
Cam for N series, panic device trims, alarms	004	\$3.93
Cam for Schlage locks	006	\$3.93
Cam for Adam Rite locks	AR18	\$3.93
Cam assembly (unequal leg prongs) for 7-pin mortise housing	C16CR-121A	\$9.61
Cam assembly (unequal leg prongs) for 6-pin mortise housing	C16CR-121A-1	\$9.61

Rim Housings for Plus Cores <sup>1</sup>	Part No.	Price
6-pin housing	C16RCR-16	\$44.45
7-pin housing	C16RCR-27	\$44.45

Rim Housing Parts	Part No.	Price
Cam bar	16RCR-44	\$2.95
Cam assembly (unequal leg prongs) for 7-pin rim housing	C16RCR-121A	\$9.61
Cam assembly (unequal leg prongs) for 6-pin rim housing	C16RCR-121A-1	\$9.61
Spring washer	16RCR-125	\$0.89
Yoke plate	961CR-117	\$1.09
Pan head screw (2 required)	4-40X1/4	\$0.50

Tools & Components	Application	Part No.	Price
IC Housing shear tool		IC281	\$212.00
MK Series IC core tailpiece pack for 6- & 7-pin cores		CM-44-201	\$5.70
RK Series 6-pin IC core tailpiece		CH6-44	\$3.52
RK Series 7-pin IC core tailpiece		CH7-44	\$3.52
RL Series 6-pin IC core tailpiece		CL6-44	\$3.52
RL Series 7-pin IC core tailpiece		CL7-44	\$3.52

<sup>1</sup> Unequal leg prongs.

<sup>2</sup> Screw-on cams. Standard 001 cam supplied unless otherwise specified.

# Cylinder Parts & Tools

IC Tools	Part No.	Price
Mortise cylinder installation tool	IC230	\$56.70
Ejector pin (single ejector)	IC235	\$39.70
50 Capping strips (200 cores)	IC237	\$74.90

## Keying Kits & Components

For conventional cylinders	Part No.	Price	
Keying kit - pins, springs, slides, retainer rings, plug followers, tail pieces	60-Key-Kit	\$260.00	
Replacement pins Note: Bulk packed 100 pcs per pack	Top pins	AD142PK	\$9.08
	Bottom pins	AB140PK to 149PK	\$9.08
	Master pins	AM142PK to 149PK	\$9.08

For IC cylinders	Part No.	Price	
Keying kit - pins, springs, cap gauge, pin ejector, capping pin	IC200	\$756.00	
Replacement pins & caps Note: Bulk packed 100 pcs per pack	Bottom pins	RB100PK to 109PK	\$10.03
	Top pins	RM102PK to 119PK	\$10.03
	Springs	100CR-107PK	\$10.03
	Barrel caps	100CR-111PK	\$10.03
Key gauge	IC205	\$20.82	
Pin ejector	IC206	\$72.60	
Replacement pin for IC206	IC206-1	\$11.88	
Capping tool	IC207	\$341.00	
Capping pin	IC208	\$69.30	
Slide cap cover	For 6-pin cores	100CR-130 <sup>1</sup>	\$54.90
	For 7-pin cores	7100CR-130 <sup>1</sup>	\$54.90

<sup>1</sup> Unit price shown. Sold in package quantities of 100.

# Architectural Panic Devices

## Features

Certification	BHMA A156.3, Grade 1, available UL Listed
Door Thickness	1-3/4"
Cylinder (where applicable)	Standard: 6-pin, solid brass, 2 nickel-silver keys; IC prep available
Handing	Right-hand Reverse (RR) or Left-hand Reverse (LR)
Warranty	5 years

Available Finishes	Arrow Code	BHMA Code	U.S. Code
Bright brass	03	605	US3
Satin brass	04	606	US4
Satin bronze	10	612	US10
Dark oxidized satin bronze, oil rubbed	10B	613	US10B
Dark oxidized satin bronze, equivalent	10BE	613E	US10BE
Bright chromium plated	26	625	US26
Satin chromium plated	26D	626	US26D
Bright stainless steel	32	629	US32
Satin stainless steel	32D	630	US32D
Aluminum painted or powder coated	AL	689	-

## How to Order

Series	<b>38</b>
Function	<b>38-88</b>
Exterior Trim & Finish (optional)	<b>38-88-SL-26D</b>
Door Width <sup>1</sup>	<b>38-88-SL-26D-F</b>
Interior Finish (pushbar)	<b>38-88-SL-26D-F-32D</b>
Handing	<b>38-88-SL-26D-F-32D-RR</b>

<sup>1</sup> F indicates a 36" wide door; E indicates a 24" door; G indicates a 48" door.



## 3880 Series Rim Panic Device

Less Trim	Part No.	AL <sup>1</sup>	10, 10B, 10BE, 32D	03, 04, 32
Exit only	38-81			
Classroom function	Less SL lever trim	38-88		
	Less pull trim	38-05		
Storeroom function	Less trim	38-83	\$1,278.00	\$1,403.00
Passage function	Less SL lever trim	38-8A		
	Less pull trim	38-5A		\$1,458.00

### Panic Device With Trim

	SL <sup>2</sup> Lever Trim	10, 10B, 10BE, 32D	03, 04, 26, 32
Classroom	38-88-SL	\$1,932.00	\$2,012.00
Storeroom	38-83-SL	\$1,932.00	\$2,012.00
Passage	38-8A-SL	\$1,886.00	\$1,966.00
Dummy Trim	38-82-SL	\$1,886.00	\$1,966.00
	SS Pull Trim	10, 10B, 10BE, 32D	03, 04, 32
Classroom	38-05-SS	\$1,772.00	\$1,852.00
Storeroom	38-83-SS	\$1,772.00	\$1,852.00
Passage	38-5A-SS	\$1,726.00	\$1,806.00
Dummy Trim	38-82-SS	\$1,726.00	\$1,806.00
	SN <sup>2</sup> Pull Trim	10, 10B, 10BE, 32D	03, 04, 32
Classroom	38-05-SN	\$1,725.00	\$1,805.00
Storeroom	38-83-SN	\$1,725.00	\$1,805.00
Passage	38-5A-SN	\$1,681.00	\$1,761.00
Dummy Trim	38-82-SN	\$1,681.00	\$1,761.00
	SB Pull Trim	10, 10B, 10BE, 32D	03, 04, 32
Classroom	38-05-SB	\$1,725.00	\$1,805.00
Storeroom	38-83-SB	\$1,725.00	\$1,805.00
Passage	38-5A-SB	\$1,681.00	\$1,761.00
Dummy Trim	38-82-SB	\$1,681.00	\$1,761.00
	SP Pull Trim	10, 10B, 10BE, 32D	03, 04, 32
Classroom	38-05-SP	\$1,725.00	\$1,805.00
Storeroom	38-83-SP	\$1,725.00	\$1,805.00
Passage	38-5A-SP	\$1,681.00	\$1,761.00
Dummy Trim	38-82-SP	\$1,681.00	\$1,761.00

### Trim Only

	SL <sup>2</sup> Lever Trim	10, 10B, 10BE, 26D	03, 04, 26
	SL88	\$529.00	\$554.00
	SL83	\$529.00	\$554.00
	SL88A	\$483.00	\$508.00
	SL02	\$483.00	\$508.00
	SS Pull Trim	10, 10B, 10BE, 32D	03, 04, 32
	SS05	\$369.00	\$394.00
	SS83	\$369.00	\$394.00
	SS05A	\$323.00	\$348.00
	SS02	\$323.00	\$348.00
	SN <sup>2</sup> Pull Trim	10, 10B, 10BE, 32D	03, 04, 32
	SN05	\$322.00	\$347.00
	SN83	\$322.00	\$347.00
	SN05A	\$278.00	\$303.00
	SN02	\$278.00	\$303.00
	SB Pull Trim	10, 10B, 10BE, 32D	03, 04, 32
	SB05	\$322.00	\$347.00
	SB83	\$322.00	\$347.00
	SB05A	\$278.00	\$303.00
	SB02	\$278.00	\$303.00
	SP Pull Trim	10, 10B, 10BE, 32D	03, 04, 32
	SP05	\$322.00	\$347.00
	SP83	\$322.00	\$347.00
	SP05A	\$278.00	\$303.00
	SP02	\$278.00	\$303.00

<sup>1</sup> AL finish applies to pushrail.

<sup>2</sup> SL trims are not available in 32D or 32 finish; 26D or 26 supplied.

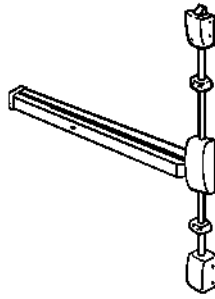

## 3700 Series Surface Vertical Rod Panic Device

Less Trim	Part No.	AL <sup>1</sup>	10, 10B, 10BE, 32D	03, 04, 32
Exit only	37-01			
Classroom function	Less SL trim	37-08		
	Less pull trim	37-05	\$1,919.00	\$2,051.00
Passage function	Less SL trim	37-8A		
	Less pull trim	37-5A		\$2,106.00

### Panic Device With Trim

	SL <sup>2</sup> Lever Trim	10, 10B, 10BE, 32D	03, 04, 26, 32
Classroom	37-08-SL	\$2,580.00	\$2,660.00
Passage	37-8A-SL	\$2,534.00	\$2,614.00
Dummy Trim	37-02-SL	\$2,534.00	\$2,614.00
	SS Pull Trim	10, 10B, 10BE, 32D	03, 04, 32
Classroom	37-05-SS	\$2,420.00	\$2,500.00
Passage	37-5A-SS	\$2,374.00	\$2,454.00
Dummy Trim	37-02-SS	\$2,374.00	\$2,454.00
	SN <sup>2</sup> Pull Trim	10, 10B, 10BE, 32D	03, 04, 32
Classroom	37-05-SN	\$2,373.00	\$2,453.00
Passage	37-5A-SN	\$2,329.00	\$2,409.00
Dummy Trim	37-02-SN	\$2,329.00	\$2,409.00
	SB Pull Trim	10, 10B, 10BE, 32D	03, 04, 32
Classroom	37-05-SB	\$2,373.00	\$2,453.00
Passage	37-5A-SB	\$2,329.00	\$2,409.00
Dummy Trim	37-02-SB	\$2,329.00	\$2,409.00
	SP Pull Trim	10, 10B, 10BE, 32D	03, 04, 32
Classroom	37-05-SP	\$2,373.00	\$2,453.00
Passage	37-5A-SP	\$2,329.00	\$2,409.00
Dummy Trim	37-02-SP	\$2,329.00	\$2,409.00
	Aux. Control	10, 10B, 10BE, 32D	03, 04, 32
Classroom	37-11-S3	\$2,450.00	\$2,530.00
Storeroom	37-12-S3	\$2,450.00	\$2,530.00

### Trim Only

	SL <sup>2</sup> Lever Trim	10, 10B, 10BE, 26D	03, 04, 26
	SL08	\$529.00	\$554.00
	SL08A	\$483.00	\$508.00
	SL02	\$483.00	\$508.00
	SS Pull Trim	10, 10B, 10BE, 32D	03, 04, 32
	SS05	\$369.00	\$394.00
	SS05A	\$323.00	\$348.00
	SS02	\$323.00	\$348.00
	SN <sup>2</sup> Pull Trim	10, 10B, 10BE, 32D	03, 04, 32
	SN05	\$322.00	\$347.00
	SN05A	\$278.00	\$303.00
	SN02	\$278.00	\$303.00
	SB Pull Trim	10, 10B, 10BE, 32D	03, 04, 32
	SB05	\$322.00	\$347.00
	SB05A	\$278.00	\$303.00
	SB02	\$278.00	\$303.00
	SP Pull Trim	10, 10B, 10BE, 32D	03, 04, 32
	SP05	\$322.00	\$347.00
	SP05A	\$278.00	\$303.00
	SP02	\$278.00	\$303.00
	Aux. Control	10, 10B, 10BE, 32D	03, 04, 32
	S311	\$399.00	\$424.00
	S312	\$399.00	\$424.00

<sup>1</sup> AL finish applies to pushrail.

<sup>2</sup> SL trims are not available in 32D or 32 finish; 26D or 26 supplied.

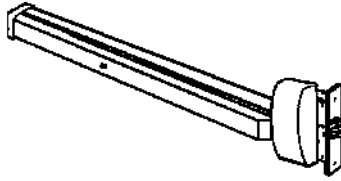

## 3900 Series Mortise Panic Device

Less Trim	Part No.	AL <sup>1</sup>	10, 10B, 10BE, 32D	03, 04, 32
Exit only	39-01			
Classroom function	Less SL lever trim	39-08		
	Less pull trim	39-05		
Storeroom function	Less trim	39-03	\$1,806.00	\$1,981.00
Passage function	Less SL lever trim	39-8A		\$2,036.00
	Less pull trim	39-5A		

### Panic Device With Trim

#### SL<sup>2</sup> Lever Trim 10, 10B, 10BE, 32D 03, 04, 26, 32

Classroom	39-08-SL	\$2,510.00	\$2,590.00
Storeroom	39-03-SL	\$2,510.00	\$2,590.00
Passage	39-8A-SL	\$2,464.00	\$2,544.00
Dummy Trim	39-02-SL	\$2,464.00	\$2,544.00

#### SS Pull Trim 10, 10B, 10BE, 32D 03, 04, 32

Classroom	39-05-SS	\$2,350.00	\$2,430.00
Storeroom	39-03-SS	\$2,350.00	\$2,430.00
Passage	39-5A-SS	\$2,304.00	\$2,384.00
Dummy Trim	39-02-SS	\$2,304.00	\$2,384.00

#### SN<sup>2</sup> Pull Trim 10, 10B, 10BE, 32D 03, 04, 32

Classroom	39-05-SN	\$2,303.00	\$2,383.00
Storeroom	39-03-SN	\$2,303.00	\$2,383.00
Passage	39-5A-SN	\$2,259.00	\$2,339.00
Dummy Trim	39-02-SN	\$2,259.00	\$2,339.00

#### SB Pull Trim 10, 10B, 10BE, 32D 03, 04, 32

Classroom	39-05-SB	\$2,303.00	\$2,383.00
Storeroom	39-03-SB	\$2,303.00	\$2,383.00
Passage	39-5A-SB	\$2,259.00	\$2,339.00
Dummy Trim	39-02-SB	\$2,259.00	\$2,339.00

#### SP Pull Trim 10, 10B, 10BE, 32D 03, 04, 32

Classroom	39-05-SP	\$2,303.00	\$2,383.00
Storeroom	39-03-SP	\$2,303.00	\$2,383.00
Passage	39-5A-SP	\$2,259.00	\$2,339.00
Dummy Trim	39-02-SP	\$2,259.00	\$2,339.00

### Trim Only

#### SL<sup>2</sup> Lever Trim 10, 10B, 10BE, 26D 03, 04, 26

SLO8	\$529.00	\$554.00
SLO3	\$529.00	\$554.00
SLO8A	\$483.00	\$508.00
SLO2	\$483.00	\$508.00

#### SS Pull Trim 10, 10B, 10BE, 32D 03, 04, 32

SS05	\$369.00	\$394.00
SS03	\$369.00	\$394.00
SS05A	\$323.00	\$348.00
SS02	\$323.00	\$348.00

#### SN<sup>2</sup> Pull Trim 10, 10B, 10BE, 32D 03, 04, 32

SN05	\$322.00	\$347.00
SN03	\$322.00	\$347.00
SN05A	\$278.00	\$303.00
SN02	\$278.00	\$303.00

#### SB Pull Trim 10, 10B, 10BE, 32D 03, 04, 32

SB05	\$322.00	\$347.00
SB03	\$322.00	\$347.00
SB05A	\$278.00	\$303.00
SB02	\$278.00	\$303.00

#### SP Pull Trim 10, 10B, 10BE, 32D 03, 04, 32

SP05	\$322.00	\$347.00
SP03	\$322.00	\$347.00
SP05A	\$278.00	\$303.00
SP02	\$278.00	\$303.00

<sup>1</sup> AL finish applies to pushrail.

<sup>2</sup> SL trims are not available in 32D or 32 finish; 26D or 26 supplied.





## 4800 Series Narrow Stile Rim Panic Device

Less Trim		Part No.	10, 10B, 10BE, 32D	03, 04, 32
Exit only		48-01		
Classroom function	Less SL lever trim	48-08	\$1,616.00	\$1,671.00
Storeroom function	Less trim	48-03		
Passage function	Less SL lever trim	48-8A		

### Panic Device With Trim

	SL <sup>1</sup> Lever Trim	10, 10B, 10BE, 32D	03, 04, 26, 32
Classroom	48-08-SL	\$2,145.00	\$2,225.00
Storeroom	48-03-SL	\$2,145.00	\$2,225.00
Passage	48-8A-SL	\$2,099.00	\$2,179.00
Dummy Trim	48-02-SL	\$2,099.00	\$2,179.00
	SS Pull Trim	10, 10B, 10BE, 32D	03, 04, 32
Storeroom	48-03-SS	\$1,985.00	\$2,065.00
Dummy Trim	48-02-SS	\$1,939.00	\$2,019.00
	SN <sup>1</sup> Pull Trim	10, 10B, 10BE, 32D	03, 04, 32
Storeroom	48-03-SN	\$1,938.00	\$2,018.00
Dummy Trim	48-02-SN	\$1,894.00	\$1,974.00

### Trim Only

	SL <sup>1</sup> Lever Trim	10, 10B, 10BE, 26D	03, 04, 26
	SL08	\$529.00	\$554.00
	SL03	\$529.00	\$554.00
	SL08A	\$483.00	\$508.00
	SL02	\$483.00	\$508.00
	SS Pull Trim	10, 10B, 10BE, 32D	03, 04, 32
	SS03	\$369.00	\$394.00
	SS02	\$323.00	\$348.00
	SN <sup>1</sup> Pull Trim	10, 10B, 10BE, 32D	03, 04, 32
	SN03	\$322.00	\$347.00
	SN02	\$278.00	\$303.00

<sup>1</sup> SL trims are not available in 32D or 32 finish; 26D or 26 supplied.

- Not available fire-rated.

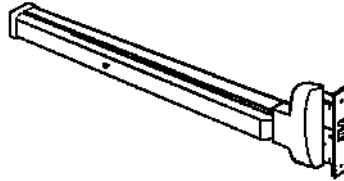

## 4900 Series Narrow Stile Mortise Panic Device

Less Trim	Part No.	10, 10B, 10BE, 32D	03, 04, 32
Exit only	49-01		
Classroom function    Less SL lever trim	49-08	\$1,820.00	\$1,875.00
Storeroom function    Less trim	49-03		
Passage function    Less SL lever trim	49-8A		

Panic Device With Trim				Trim Only		
	SL <sup>1</sup> Lever Trim	10, 10B, 10BE, 32D	03, 04, 26, 32	SL <sup>1</sup> Lever Trim	10, 10B, 10BE, 26D	03, 04, 26
Classroom	49-08-SL	\$2,349.00	\$2,429.00	SL08	\$529.00	\$554.00
Storeroom	49-03-SL	\$2,349.00	\$2,429.00	SL03	\$529.00	\$554.00
Passage	49-8A-SL	\$2,303.00	\$2,383.00	SL08A	\$483.00	\$508.00
Dummy Trim	49-02-SL	\$2,303.00	\$2,383.00	SL02	\$483.00	\$508.00
	SS Pull Trim	10, 10B, 10BE, 32D	03, 04, 32	SS Pull Trim	10, 10B, 10BE, 32D	03, 04, 32
Storeroom	49-03-SS	\$2,189.00	\$2,269.00	SS03	\$369.00	\$394.00
Dummy Trim	49-02-SS	\$2,143.00	\$2,223.00	SS02	\$323.00	\$348.00
	SN <sup>1</sup> Pull Trim	10, 10B, 10BE, 32D	03, 04, 32	SN <sup>1</sup> Pull Trim	10, 10B, 10BE, 32D	03, 04, 32
Storeroom	49-03-SN	\$2,142.00	\$2,222.00	SN03	\$322.00	\$347.00
Dummy Trim	49-02-SN	\$2,098.00	\$2,178.00	SN02	\$278.00	\$303.00

<sup>1</sup> SL trims are not available in 32D or 32 finish; 26D or 26 supplied.

# Architectural Panic Device Options

Architectural Panic Device Options	Specify	Price	
Rail Size	For 24" to 32" door widths	E	No Add
	For 32-1/4" to 36" door widths	F	Standard
	For 36-1/4" to 48" door widths	G	No Add
Handing	Right-hand reverse	RR	n/a
	Left-hand reverse	LR	n/a
UL Fire label (except 3700 & 4800 Series)	FR	\$199.00	
UL Fire label for 3700 Series <sup>1</sup>	FR	\$225.00	
Cylinder dogging (includes cylinder) (not available with UL fire label devices)	CD	\$94.50	
3700 Series less bottom rod	LBR <sup>2</sup>	No Add	
Fire-rated 3700 Series less bottom rod	LBR <sup>2</sup>	\$76.40	
Sliding bottom bolt for 3700 Series	SB <sup>3</sup>	No Add	
Vandal-proof lever	VP <sup>2</sup>	\$340.00	
Knurled outside lever	103 <sup>2</sup>	\$93.50	

Keying & Cylinder Options (when ordering trim)	Specify	Price
Keyed different	KD	Standard
Master keyed	MK	\$14.75 per cylinder
Construction master keyed	CMK	\$9.30 per cylinder
Master keyed & construction master keyed	MK-CMK	\$24.05 per cylinder
O-Bitted	OB	No Add
Less cylinder	LC	-\$15.10
Exit trim prepared to accept 6 or 7-pin SFIC cylinder, less core	IC	No Add

<sup>1</sup> Includes thru-bolts.

<sup>2</sup> Used only with SL trim.

<sup>3</sup> Cannot be combined with FR option.

# Architectural Panic Device Electrification Options

Architectural Panic Device Electrification Option	Voltage	Specify	Price Add <sup>1</sup>
Fail-safe trim control without key override <sup>2</sup>	12V AC/DC	177	\$916.00
	24V AC/DC	179	\$916.00
Fail-secure trim control without key override <sup>2</sup>	12V AC/DC	181	\$916.00
	24V AC/DC	183	\$916.00
Fail-safe trim control with key override <sup>3</sup>	12V AC/DC	185	\$1,111.00
	24V AC/DC	186	\$1,111.00
Fail-secure trim control with key override <sup>3</sup>	12V AC/DC	187	\$1,111.00
	24V AC/DC	188	\$1,111.00
Latchbolt monitoring <sup>5</sup>		LM	\$310.00
Request to exit - authorized <sup>6</sup>		RE	\$310.00
Electric latch retraction <sup>4,6</sup>		E6	\$1,208.00
Signal switch <sup>6,7</sup>		E7	\$447.00
Electric dogging <sup>6</sup>		E8	\$955.00

<sup>1</sup> Electrification charges do not include price of panics.

<sup>2</sup> SL trim only; not available with 3900 or 4900 Series.

<sup>3</sup> SL trim only; not available with 3700 or 4800 Series.

<sup>4</sup> Cannot be combined with options: CD, LM, RE, and E7; not available in rail size E.

<sup>5</sup> Not available with 4800 Series.

<sup>6</sup> Not available with 488A or 4808.

<sup>7</sup> Not available with 3800 Series, 3701, 3702, 375A, 3711, 3712, 488A, 4808.

- **Fail-Safe Trim Control**

Power on locks outside lever. Inside lever always free. For options 185, 186, 187, and 188, latch retracted by key when locked electronically.

- **Fail-Secure Trim Control**

Power off locks outside lever. Inside lever always free. For options 185, 186, 187, and 188, latch retracted by key when locked electronically.

- **Latchbolt Monitoring**

Full extension of the latch monitored by a SPDT switch.

- **Request to Exit — Authorized Egress**

Inside trim monitored by an SPDT switch. Switch can be used to shunt a door alarm to allow egress, signal a control console when the trim is activated, or activate a door alarm.

- **Electric Latch Retraction**

Provides a remote means of unlocking exit devices by momentary or maintained latch retraction.

- **Signal Switch**

Consists of two SPDT switches that monitor the touch bar and main latch. This feature also allows for alarm shunt via a mortise cylinder (not included) located on the tail of the exit device

- **Electric Dogging**

Simultaneously provides continuous latch retraction and dogging. When energized, first time mechanical activation of the push bar will continuously hold the latch retracted. When power is removed or interrupted, the latch bolt will extend and the push bar released.

# S1150, S1250, ED910, & PEC910 Series Panic Devices

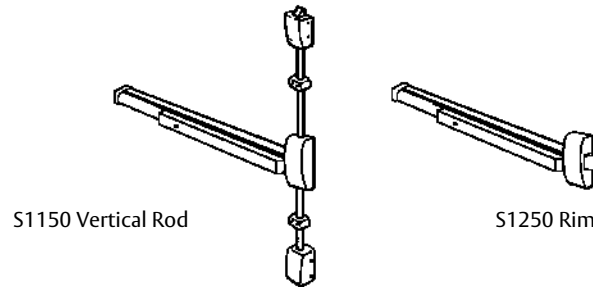

## S1150/S1250 Devices Less Trim

Standard Panic Devices for 32-1/4" to 36" Door Widths	AL, BRZ, LBZ	Price
Surface vertical rod	S1150	\$792.00
Rim	S1250	\$417.00

Fire-Rated Panic Devices for 32-1/4" to 36" Door Widths	AL, BRZ, LBZ	Price
Surface vertical rod	FS1150	\$979.00
Rim	FS1250	\$582.00

Panic Device Options	Add Suffix	Price Add
Cylinder dogging	CD	\$94.50
Cylinder dogging prepared to accept 6- or 7-pin SFIC cylinder (not included)	CDIC	\$94.50
For 24" to 32" door widths	24	No Add
For 36-1/4" to 48" door widths	48	No Add

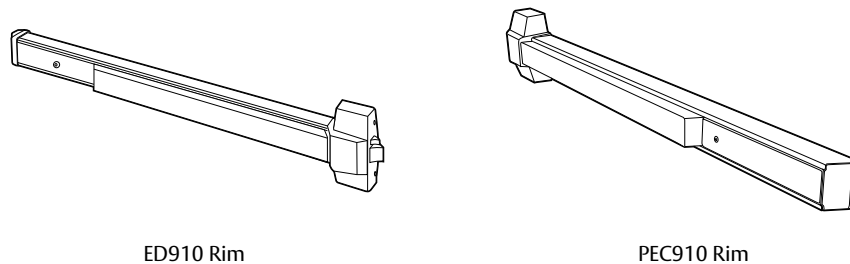

## ED910/PEC910 Panic Devices

ED910 Rim Panic Device	Part No.	689, 613E	630
For 31" to 36" door widths	ED910-36	\$266.00	\$362.00
For 43" to 48" door widths	ED910-48	\$266.00	\$362.00

PEC910 Permanent End Cap Rim Panic Device	Part No.	689, 613E	630
For 31" to 36" door widths	PEC910-36	\$323.00	\$418.00

Parts	Part No.	689, 613E	630
Strike	ES90	\$26.65	-
Screw pack	ES9-201	\$14.22	\$14.22
End cap	ES9CAP	\$23.99	\$23.99
Installation Template	ES9TMPLT-36	\$105.00	-

Experience a safer  
and more open world

# S1150, S1250, ED910, & PEC910 Series Exit Trim

## Trims

<b>Lever Trim</b>		<b>613E, 26D</b>	<b>Price</b>
Passage		SRX01	\$127.00
Storeroom	Standard cylinder	SRX82	\$127.00
	SFIC prep, less core	SRX82-IC	\$127.00
Classroom	Standard cylinder	SRX87	\$127.00
	SFIC prep, less core	SRX87-IC	\$127.00

<b>Knob Trim</b>		<b>03, 04, 10, 10B, 26D</b>	<b>Price</b>
Passage		BD01 or TA01	\$164.00
Storeroom	Standard cylinder	BD12 or TA12	\$179.00
	SFIC prep, less core	TA12-IC	\$204.00
Classroom	Standard cylinder	BD17 or TA17	\$179.00
	SFIC prep, less core	TA17-IC	\$204.00

<b>Plate Trim</b>		<b>AL, BRZ, LBZ</b>	<b>Price</b>
Blank Plate		SF01	\$73.00
Dummy Pull		SF02	\$79.00
Storeroom	Standard cylinder	SF12	\$129.00
	SFIC prep, less core	SF12-IC	\$129.00

# Panic Device Accessories

Accessories		Part No.	Price
Shim kit for 3880 or 3900 Series		S59	\$101.00
Shim kit for 3700 Series		S57	\$123.00
Shim kit for S1150		SH64	\$142.00
Shim kit for S1250		SH65	\$116.00
18" Extension rod kit for 3700 or S1150 Series		VRX-18	\$116.00
Dummy push rail for 3000 & 4000 Series (specify plated finish)	For 24" to 32" door widths	S3000-24	\$436.00
	For 32-1/4" to 36" door widths	S3000-36	\$436.00
	For 36-1/4" to 48" door widths	S3000-48	\$436.00
Dummy push rail for 3000 & 4000 Series (specify sprayed finish)	For 24" to 32" door widths	S3000-24	\$348.00
	For 32-1/4" to 36" door widths	S3000-36	\$348.00
	For 36-1/4" to 48" door widths	S3000-48	\$348.00

## Thru-Bolts

Series	Description	Part No.	Price
3880	Standard & fire-rated	FS54	\$22.13
	Standard	S53	\$64.40
3700	UL fire-rated	FS53	\$73.60
	Standard & fire-rated	FS54	\$22.13
4800	Standard	FS65	\$22.13
4900	Standard & fire-rated	FS65	\$22.13
S1150	Standard	S51	\$64.40
	UL fire-rated	FS51	\$73.60
S1250	Standard & fire-rated	FS52	\$22.13

Mullions	Part No.	Price
Removable mullion - 96"	S20	\$510.00
Removable mullion - 120"	S20-120	\$593.00
Key removable mullion - 96", less cylinder	S20-K	\$1,120.00
Key removable mullion - 120", less cylinder	S20L-K	\$1,173.00
Removable mullion for narrow stile - 96"	S20-N	\$1,095.00
Removable mullion for narrow stile - 120"	S20-N-120	\$1,273.00
Fire-rated removable mullion - 96"	S21	\$684.00
Fire-rated key removable mullion - 96", less cylinder	S21-K	\$1,277.00
Top Retainer for S20	S10	\$57.10
Bottom retainer for S20	S11A	\$57.10
Top retainer for S20-N	S91	\$97.40
Bottom retainer for S20-N	S92	\$97.40
Stabilizer for S20-N	S90	\$57.10
Top retainer for S21	S88	\$97.40
Bottom retainer for S21	S89	\$97.40
Mortise cylinder for key removable mullion	MC61-004	\$45.35
IC housing for key removable mullion	16CR-27X004	\$44.45

# Panic Device Parts

Parts	Part No.	Price	
SL08 spindle adapter (converts trim to SL88)	SL-386A	\$34.90	
SL08 spindle adapter (required when using trim with 4800 Series)	SLS-386A	\$47.85	
SL trim cover plate (covers stock hollow metal cut-out)	38-88A	\$175.00	
	Storeroom function	SL93	\$413.00
	Classroom function for thumb pull trim	SL95	\$413.00
Mortise lockbody for 3900 or 4900 Series	Passage function for thumb pull trim	SL95A	\$413.00
	Classroom function for SL trim	SL98	\$413.00
	Passage function for SL trim	SL98A	\$413.00
End cap for 3000 & 4000 Series	32-7027	\$23.99	
End cap mounting bracket for 3000 & 4000 Series	68-2141	\$23.99	
End cap for S1150 & S1250 Series	28-0112	\$23.99	
End cap mounting bracket for S1150 & S1250 Series	68-0080	\$23.99	
Dogging kit (dogging key sold separately)	68-2596	\$23.99	
Dogging key	97-0001	\$11.12	

Rail Assembly - S1150 & S1250 Series	Part No.	Fire Rated Part No.	AL, BRZ
For 24" to 32" door widths	PR-24	PRF-24	\$301.00
For 32-1/4" to 36" door widths	PR-36	PRF-36	\$301.00
For 36-1/4" to 48" door widths	PR-48	PRF-48	\$301.00

Rail Assembly - S1150 & S1250 Series w/ Cylinder Dogging	Part No.	AL, BRZ
For 24" to 32" door widths	PR-24CD	\$395.50
For 32-1/4" to 36" door widths	PR-36CD	\$395.50
For 36-1/4" to 48" door widths	PR-48CD	\$395.50

Rail Assembly - 3000 Series	Part No.	Fire Rated Part No.	03, 04, 10, 10B, 32, 32D
For 24" to 32" door widths	R-24	RF-24	\$456.00
For 32-1/4" to 36" door widths	R-36	RF-36	\$456.00
For 36-1/4" to 48" door widths	R-48	RF-48	\$456.00

Rail Assembly - 3000 Series w/ Cylinder Dogging	Part No.	03, 04, 10, 10B, 32, 32D
For 24" to 32" door widths	RCD-24	\$550.50
For 32-1/4" to 36" door widths	RCD-36	\$550.50
For 36-1/4" to 48" door widths	RCD-48	\$550.50

Rail Assembly - 4000 Series	Part No.	Fire Rated Part No.	03, 04, 10, 10B, 32, 32D
For 24" to 32" door widths	R-24-4	RF-24-4	\$456.00
For 32-1/4" to 36" door widths	R-36-4	RF-36-4	\$456.00
For 36-1/4" to 48" door widths	R-48-4	RF-48-4	\$456.00

Rail Assembly - 4000 Series w/ Cylinder Dogging	Part No.	03, 04, 10, 10B, 32, 32D
For 24" to 32" door widths	RCD-24-4	\$550.50
For 32-1/4" to 36" door widths	RCD-36-4	\$550.50
For 36-1/4" to 48" door widths	RCD-48-4	\$550.50

Experience a safer  
and more open world



# Panic Device Strikes

## Strikes

Series	Description	Part No.	Price
3880	Standard & fire rated	S38	\$50.30
	Double door	S36	\$50.30
3700	Standard & fire-rated	S646	\$55.40
	Standard bottom	S23	\$55.40
	UL fire-rated bottom	S43	\$55.40
3900	Standard	S48C	\$32.90
	Open back	S47	\$50.30
4800	Standard	S38	\$50.30
	Double door	S36	\$50.30
	Flush	S56	\$50.30
4900	Standard	S48C	\$32.90
	Open back	S47	\$50.30
S1150	Standard & fire-rated	S646	\$55.40
	Standard bottom	S23	\$55.40
	UL fire-rated bottom	S43	\$55.40
S1250	Standard & fire rated	S38	\$50.30
	Double door	S36	\$50.30

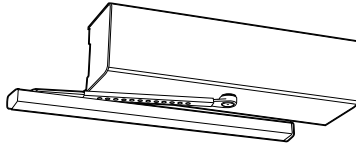

# 7700 Series Door Operator

## Powered Door Operator

Hinge (Pull) Side of Door	Part No.	AL, DBZ
Standard unit	7710	\$2,037.00
Standard unit with (1) 7710SW5 wall switch	7710K1	\$2,293.00
Standard unit with power cord	7710P	\$2,064.00
Standard unit with power cord & (1) 7710SW5 wall switch	7710PK1	\$2,320.00
Radio frequency unit	7710RF1	\$2,185.00
Radio frequency unit with (1) 7800T1 transmitter	7710EX	\$2,334.00
Radio frequency unit with power cord	7710PRF1	\$2,212.00
Radio frequency unit with power cord & (1) 7800T1 transmitter	7710PEX	\$2,361.00

Stop (Push) Side of Door	Part No.	AL, DBZ
Standard unit	7730	\$2,037.00
Standard unit with (1) 7710SW5 wall switch	7730K1	\$2,293.00
Standard unit with power cord	7730P	\$2,064.00
Standard unit with power cord & (1) 7710SW5 wall switch	7730PK1	\$2,320.00
Radio frequency unit	7730RF1	\$2,185.00
Radio frequency unit with (1) 7800T1 transmitter	7730EX	\$2,334.00
Radio frequency unit with power cord	7730PRF1	\$2,212.00
Radio frequency unit with power cord & (1) 7800T1 transmitter	7730PEX	\$2,361.00

Parts & Accessories	Part No.	Price
Door Switch - 6" sq., Stainless/Blue Letters, ADA Symbol, Radio Frequency	7800SW2	\$343.00
Door Switch - 6" sq., Stainless/Blue Letters, ADA Symbol, Hard Wired	7800SW3	\$208.00
Door Switch - 6" sq., Stainless/Blue Letters, Radio Frequency	7800SW1	\$343.00
Door Switch - 6" sq., Stainless/Blue Letters, Hard Wired	7800SW4	\$208.00
Touchless Wall Switch	7710SW5	\$555.00
Radio Frequency (RF1) Kit	7710RK	\$175.00
Power Cord	7710PC	\$27.00
Inverter	7710IN	\$794.00
Cover	7710COV	\$125.00
Motor and Main Arm Assembly	7710M	\$1,411.00
Motor, Main Arm and Tube Assembly	7730M	\$1,411.00
Power Supply	7710PS	\$133.00
Motor Assembly	7800MA	\$1,301.00
Screw Pack	7710SP	\$31.00

## 7800/7900 Series Door Operator

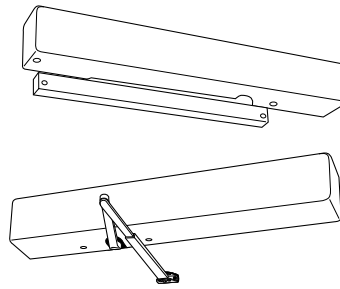

### 7800 Series Power Door Operators – Sizes 1-6

Mount Application	Radio Frequency	2 Wall Switches	Part No.	AL, DBZ
Hinge/Pull			7836H	\$3,744.00
	✓		7836HR	\$3,892.00
	✓	✓	7836HRP	\$4,578.00
Stop/Push			7836S	\$3,744.00
	✓		7836SR	\$3,892.00
	✓	✓	7836SRP	\$4,578.00
Universal			7836U	\$3,785.00
	✓		7836UR	\$3,933.00

### 7900 Series Power Door Operators (Power Cord Version) – Sizes 1-6

Mount Application	Radio Frequency	2 Wall Switches	Part No.	AL, DBZ
Hinge/Pull			7936H	\$3,771.00
	✓		7936HR	\$3,919.00
	✓	✓	7936HRP	\$4,605.00
Stop/Push			7936S	\$3,771.00
	✓		7936SR	\$3,919.00
	✓	✓	7936SRP	\$4,605.00
Universal			7936U	\$3,812.00
	✓		7936UR	\$3,960.00

# 7800/7900 Series Parts

Parts/Accessories	Part No.	Price
Motor Assembly	7800MA	\$1,301.00
Inverter	7800IN	\$794.00
On/Off Switch	7800PS	\$7.40
Cover	7800CO	\$125.00
Arm & Track Assembly (Pull)	7800TC	\$374.00
Arm Assembly	7800TA	\$129.00
Track Assembly	7800TO	\$262.00
Arm Assembly (Push)	7800SC	\$123.00
Main Arm & Rod	7800SA	\$109.00
Adjusting Tube & Shoe	7800ST	\$47.00
Single Channel Hand Held Transmitter	7800T1	\$149.00
Double Channel Hand Held Transmitter	7800T2	\$189.00
Reed Switch	7800RS	\$26.00
RF Power Supply	7800PWS	\$133.00
Operational Signs	7800SK9	\$53.00
Signage Kit 1	7800SK1	\$8.00
Signage Kit 2	7800SK2	\$8.00
Closer Body	914BO	\$228.00

# DCN300 Series

## Door Closer

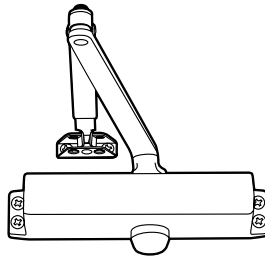

### Standard Features

ANSI/BHMA A156.4	Sizes	Cover	Thru-Bolts
Certified Grade 1	1-4 & 1-6	Sold Separately	Included

Case Quantity	Average Case Weight	Warranty
3	20 lbs	5 Year Limited

Finishes	Arrow Code	BHMA Code
Aluminum painted or powder coated	689	689
Dark bronze painted or powder coated	690	690
Black painted or powder coated*	693*	693*

\*Available through select distributors. Contact Arrow Lock for more information.

DCN300 Surface Applied Door Closers	Part No.	Price
Size 1-4, NHO, Tri-Pack	DCN314	\$186.00
Size 1-4, HO, Tri-Pack	DCN314-1	\$219.00
Size 1-6 NHO, Tri-Pack	DCN325	\$186.00
Size 1-6, HO, Tri-Pack	DCN325-1	\$219.00

Parts & Accessories	Part No.	Price
Full Plastic Cover & 1-3/8" Thru-Bolts	DC3CVR	\$30.20
Thru-Bolts 1-3/4"	DCNTB1	\$7.68
Thru-Bolts 2-1/4"	DCNTB2	\$7.68

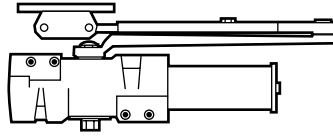

# DCN500 Series

## Door Closer

### Standard Features

ANSI/BHMA A156.4	Sizes	Cover	Thru-Bolts
Certified Grade 1	1-6	Included	Included

Case Quantity	Average Case Weight	Warranty
3	40 lbs	10 Years

Finishes	Arrow Code	BHMA Code
Aluminum painted or powder coated	689	689
Dark bronze painted or powder coated	690	690
Black painted or powder coated*	693*	693*

\*Available through select distributors. Contact Arrow Lock for more information.

Description	Part No.	Price
Sizes 1-6, NHO, Tri-Pack	DCN516	\$292.00
Sizes 1-6, HO, Tri-Pack	DCN516-1	\$355.00
Sizes 1-6, HD, NHO, PA, Positive Stop	DCN516-2	\$353.00
Sizes 1-6, HD, HO, PA, Thumbturn, Positive Stop	DCN516-3	\$388.00

Parts & Accessories	Part No.	Price
Full Plastic Cover	DCN500CV	\$28.50
Drop Plate - Regular	DCN500DP	\$27.60
Drop Plate - Parallel Arm	DCN500DP1	\$30.50
Drop Plate - Top Jamb	DCN500DP2	\$27.60
Drop Plate - Top Jamb, Flush Ceiling	DCN500DP3	\$27.60
Thru-bolts 1-3/4"	DCNTB1	\$7.68
Thru-bolts 2-1/4"	DCNTB2	\$7.68
Screw Pack	DCN500SP	\$12.26
NHO Arm	DCN500A	\$99.70
HO Arm	DCN500A1	\$116.00
HD NHO Arm	DCN500A2	\$121.00
HD HO Arm	DCN500A3	\$135.00
HD NHO Cushion Arm Kit	DCN500A4	\$157.00
HD HO Cushion Arm Kit	DCN500A5	\$178.00

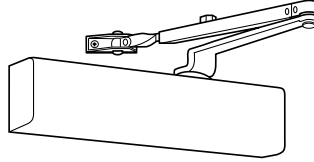

## 5016N Series Door Closer

Tri-pack Models – Sizes 1-6	Part No.	Price
Standard arm, slim plastic cover	5016NS	\$410.00
Standard arm, full plastic cover	5016N	\$413.00
Standard arm, slim plastic cover, delayed action	5016NSD	\$456.00
Standard arm, full plastic cover, delayed action	5016ND	\$460.00
Hold-open arm, slim plastic cover	5016NSH	\$459.00
Hold-open arm, full plastic cover	5016NH	\$462.00
Hold-open arm, slim plastic cover, delayed action	5016NSHD	\$435.00
Hold-open arm, full plastic cover, delayed action	5016NHD	\$448.00

Door Saver Parallel Arm Models – Sizes 1-6	Part No.	Price
Slim plastic cover	5016NPS	\$460.00
Full plastic cover	5016NP	\$464.00
Slim plastic cover, delayed action	5016NPSD	\$505.00
Full plastic cover, delayed action	5016NPD	\$509.00
Hold-open arm, slim plastic cover	5016NPSH	\$522.00
Hold-open arm, full plastic cover	5016NPH	\$525.00
Hold-open arm, slim plastic cover, delayed action	5016NPSHD	\$567.00
Hold-open arm, full plastic cover, delayed action	5016NPHD	\$570.00

Parts & Accessories	Part No.	Price
Drop plate	5016DP	\$51.00
Full plastic cover	5016FC	\$32.00
Slim plastic cover	5016SC	\$28.00
5016N Closer body	5016BO	\$283.00
5016N Closer body with delayed action	5016BOD	\$325.00
Thru-bolts for 1-3/8" thick doors	5016TB38	\$14.00
Thru-bolts for 1-3/4" thick doors	5016TB34	\$14.00
Thru-bolts for 2-1/4" thick doors	5016TB214	\$14.00
Complete (tri-pack) standard arm assembly	5016CNA	\$99.00
Complete (tri-pack) hold-open arm assembly	5016CHA	\$144.00
Door saver arm assembly, non-hold-open	5016CDNA	\$172.00
Door saver arm assembly, hold-open	5016CDHA	\$236.00

- Packed 4 per case. Average case weight 16 lbs.
- Specify AL, DBZ, LBZ, GL, or BLK finish.

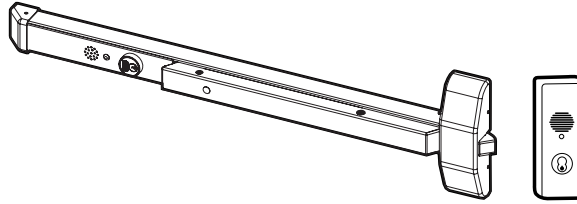

AL500

130N

## AL500 & 130N Series Alarmed Hardware

Push Bar Alarm (handed)	Part No.	689, 690, BSP, RD	630
For 32-1/4" to 36" door width	AL500 <sup>1</sup>	\$1,010.00	\$1,197.00
	AL500F (fire rated) <sup>1</sup>	\$1,155.00	\$1,342.00
For 36-1/4" to 48" door width	AL500-48 <sup>1</sup>	\$1,010.00	\$1,197.00
	AL500F-48 (fire rated) <sup>1</sup>	\$1,155.00	\$1,342.00

Stand Alone Alarm	Part No.	Price
Standard unit	130N	\$391.00
Standard unit with remote mounting	130NXL	\$451.00

AL500 Lever Trim	Description	10B, 26D	Price
Passage		SRX01	\$127.00
	Standard cylinder	SRX82	\$127.00
Storeroom	SFIC prep, less core	SRX82-IC	\$127.00
	Standard cylinder	SRX87	\$127.00
Classroom	SFIC prep, less core	SRX87-IC	\$127.00

AL500 Knob Trim	Description	03, 04, 10, 10B, 26D	Price
Passage		BD01 or TA01	\$164.00
	Standard cylinder	BD12 or TA12	\$179.00
Storeroom	SFIC prep, less core	TA12-IC	\$204.00
	Standard cylinder	BD17 or TA17	\$179.00
Classroom	SFIC prep, less core	TA17-IC	\$204.00

AL500 Plate Trim	Description	689, 690, BSP, RD	Price
Passage		PT01	\$73.00
Dummy Pull		PT02	\$79.00
Classroom	Standard cylinder	PT03	\$134.00
	SFIC prep, less core	PT03-IC	\$134.00

AL500 Parts	Part No.	Price
Single door strike	S38	\$50.30
Double door strike	S36	\$50.30
Thru-bolts	FS54	\$22.13
Mortise cylinder for inside rail	MC61-004	\$45.35
IC Housing for inside rail	16CR-27X004	\$44.45

<sup>1</sup> Inside cylinder to arm or disarm unit sold separately.



# Discontinued Products

**ASSA ABLOY**

February 1, 2022

## Arrow Revolution Yale Replacement Part Numbers

V1 Part Number (discontinued)	Replaced By Yale Part Number	Description
N/A	AUNTB610NR-626-100CV1-6	NXTOUCH-PB-AU-626-ARKD
N/A	AUNTB610NR-626-2803-53L-6	NXTOUCH-PB-AU-626-CSKD
N/A	AUNTB610NR-626-ICLC	NXTOUCH-PB-AU-626-IC
V151-SR-26D-V14-V44-AR-KD	AUNTB620NR-626-100CV1-6	NXTOUCH-TS-AU-626-ARKD
V151-SR-26D-V14-V44-CS-KD	AUNTB620NR-626-2803-53L-6	NXTOUCH-TS-AU-626-CSKD
V151-SR-26D-V14-V44-IC	AUNTB620NR-626-ICLC	NXTOUCH-TS-AU-626-IC

V2 Part Number (discontinued)	Replaced By Yale Part Number	Description
V251-10BP-V2S-V2L-CS-KD	YRD226NR-0BPSC	YRL-DB-TS-NR-US10BP-SC
V251-03-V2S-V2L-CS-KD	YRD226NR-605SC	YRL-DB-TS-NR-US3-SC
V251-15-V2S-V2L-CS-KD	YRD226NR-619SC	YRL-DB-TS-NR-US15-SC

V3 Part Number (discontinued)	Replaced By Yale Part Number	Description
V351-LR-10BP-V3S-V3L-CS-KD	YRL220NR-0BPSC	YRL-LL-TS-NR-US10BP-SC
V351-LR-03-V3S-V3L-CS-KD	YRL220NR-605SC	YRL-LL-TS-NR-US3-SC
V351-LR-15-V3S-V3L-CS-KD	YRL220NR-619SC	YRL-LL-TS-NR-US15-SC

**CONTACT CUSTOMER SERVICE FOR ADDITIONAL INFORMATION.**

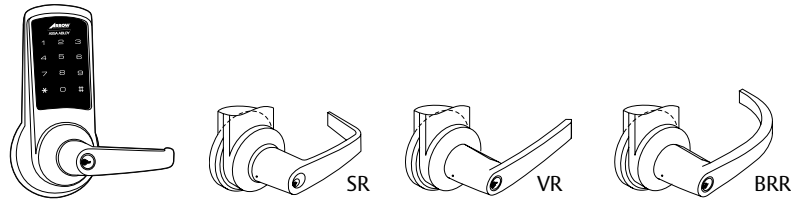

**DISCONTINUED. LIMITED AVAILABILITY THROUGH DISTRIBUTION ONLY.  
CONTACT CUSTOMER SERVICE FOR ADDITIONAL INFORMATION.**

**Features**

Certification	BHMA A156.2, Series 4000, Grade 1
Door Thickness	1-3/4", kit available for 1-3/8" thick doors
Strike	Standard: ANSI 1-1/4" x 4-7/8"; T-strike available
Latch	2-3/4" backset, 1-1/8" front
Cylinder	Standard: 6-pin, solid brass, 2 nickel-silver keys; IC prep available
Handing	Non-handed
Case Quantity	3
Average Case Weight	22 lbs.
Warranty	3 years

Available Finishes	Arrow Code	BHMA Code	U.S. Code
Bright Brass	03	605	US3
Dark Oxidized Satin Bronze, equivalent	10BE	613E	US10BE
Satin Chromium Plated	26D	626	US26D

**How to Order**

Function	<b>V151</b>
Trim	V151-SR
Finish	V151-SR-26D
Strike	V151-SR-26D-V14
Latch	V151-SR-26D-V14-V44
Keying	V151-SR-26D-V14-V44-KD-AR

Strike Options	Specify
ANSI	V14
T-Strike	V18
ANSI with box strike	V10

Latch Options	Specify
2-3/4" backset, 1-1/8" beveled front	V44
2-3/4" backset, 1-1/8" flat front	V45

Keying & Cylinder Options	Specify
Keyed different	KD
Less Cylinder	LC
O-Bitted	OB
Lock prepared to accept a 6- or 7-pin SFIC cylinder (not included)	IC
Lock prepared to accept an LFIC Medeco or ASSA cylinder (not included)	LIC <sup>1</sup>
Lock prepared to accept an LFIC Schlage cylinder (not included)	SIC <sup>1</sup>
Lock prepared to accept an LFIC Corbin Russwin cylinder (not included)	CIC <sup>1</sup>

<sup>1</sup> Available only with SR trim.

# V1 Series

## Parts

**DISCONTINUED. LIMITED AVAILABILITY THROUGH DISTRIBUTION ONLY.  
CONTACT CUSTOMER SERVICE FOR ADDITIONAL INFORMATION.**

<b>Strikes</b>	<b>Part No.</b>
ANSI Strike, 1-1/4" lip	V14
T-Strike, 1-1/4" lip	V18
Box strike	V10
<b>Latches</b>	<b>Part No.</b>
2-3/4" Backset, 2-1/4" x 1-1/8" beveled front	V44
2-3/4" Backset, 2-1/4" x 1-1/8" flat front	V45
2-3/4" Backset, 2-1/4" x 1" front	V35 <sup>1</sup>
2-3/8" Backset, 2-1/4" x 1" front	V38 <sup>1</sup>
<b>Cylinder &amp; Related</b>	<b>Part No.</b>
Standard AR cylinder with tailpiece	100C-V1
Alternate CS cylinder with tailpiece	100CS-V1
Standard keyblank	K6A
Tailpiece for standard cylinder	550V1-44
<b>Parts &amp; Accessories</b>	<b>Part No.</b>
Inside SR lever - all functions	MS-01A-V1A
Outside SR lever - standard cylinder prep; less cylinder	MS-56A-V1
Outside escutcheon assembly (o/s escutcheon; touchscreen assembly)	V1-ESC-OS
Inside escutcheon assembly (i/s escutcheon, electronics, batteries, battery cover)	V1-ESC-IS
1-3/8" Thin door kit (includes I/S & O/S escutcheon spacers and a V38 <sup>1</sup> latch)	V1-KIT1
Motorized lock chassis	V15X-LB
Battery cover	V1-BCOV
Weather gasket kit (inside & outside gasket replacements)	V1-GSK-PK
Remote unlock and power wire harness	V1-RMTE
5" Extension link (used only with V44 or V45 latches)	V25 x 5 <sup>1</sup>
Pro-Lok door prep template for the Arrow V1 Series	IN490
Pro-Lok universal clamp for holding door prep template	INCL
Trimplate pack (included 3 pairs with screws)	RP1
Display mount	MOUNT-V1
Lever return spring	14-5300-1021-999

<sup>1</sup> Sold only as a separate part. Not tested to grade 1 specifications. If substituted for standard latch, grade 1 rating is voided.

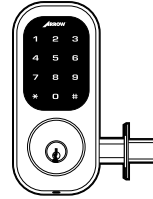

V251 Touchscreen

**DISCONTINUED. LIMITED AVAILABILITY THROUGH DISTRIBUTION ONLY.  
CONTACT CUSTOMER SERVICE FOR ADDITIONAL INFORMATION.**

**Features**

Certification	BHMA A156.36, Grade 2
Door Thickness	Fits 1-3/8" to 2-1/4", factory set for 1-3/4" (gasket req. for 1-3/8" thick door)
Strike	1-1/8" x 2-3/4", round corners
Latch	2-3/8" - 2-3/4" adjustable backset, 1" front, round corners
Cylinder	Standard: 6-pin, solid brass, 2 brass keys; IC prep available
Handing	Non-handed
Case Quantity	5
Average Case Weight	11 lbs.

Available Finishes	Arrow Code	BHMA Code	U.S. Code
Bright Brass	03	605	US3
Dark Oxidized Satin Bronze, Clear Coated	10BP	614	US10BL
Satin Nickel	15	619	US15

**How to Order**

Function	<b>V251</b>
Finish	<b>V251-15</b>
Strike	<b>V251-15-V2S</b>
Latch	<b>V251-15-V2S-V2L</b>
Keying	<b>V251-15-V2S-V2L-CS-KD</b>

Options	Specify
Strike	V2S
Latch	V2L
Keyed Different	KD
V251 function prepared to accept 6- or 7-pin SFIC cylinder (not included)	IC

Parts & Accessories	Part No.
Strike	V2S
Latch	V2L
Drive-in latch <sup>1</sup>	V2LD
Standard CS cylinder with tailpiece	96CS-V2
Alternate AR cylinder with tailpiece	96C-V2
Tailpiece for standard cylinder	V2-44
Battery cover	V2-BCOV
V251 gasket for 1-3/8" thick door	V23-51-GSK
Display mount	MOUNT-V23

<sup>1</sup> Sold only as a separate part.

# V3 Series



V351 Touchscreen

**DISCONTINUED. LIMITED AVAILABILITY THROUGH DISTRIBUTION ONLY.  
CONTACT CUSTOMER SERVICE FOR ADDITIONAL INFORMATION.**

### Features

Certification	BHMA A156.36, Grade 2
Door Thickness	Fits 1-3/8" to 1-3/4", factory set for 1-3/4"
Strike	Full lip 1-3/8" x 2-3/4", round corners
Latch	2-3/8" - 2-3/4" adjustable backset, 1" front, round corners
Cylinder	Standard: 5-pin, solid brass, 2 brass keys
Handing	Non-handed
Case Quantity	5

Available Finishes	Arrow Code	BHMA Code	U.S. Code
Bright Brass	03	605	US3
Dark Oxidized Satin Bronze, Clear Coated	10BP	614	US10BL
Satin Nickel	15	619	US15

### How to Order

Function & Trim	<b>V351-LR</b>
Finish	V351-LR-03
Strike	V351-LR-03-V3S
Latch	V351-LR-03-V3S-V3L
Keying	V351-LR-03-V3S-V3L-CSKD

Strike Option	Specify
Full lip 1-3/8" x 2-3/4"	V3S

Latch Option	Specify
2-3/8" - 2-3/4" adjustable backset, 1" front	V3L

Keying & Cylinder Option	Specify
Keyed different, CS keyway	CSKD

Parts & Accessories	Part No.
Cylinder	100C-V3
Strike	V3S
Latch	V3L
Drive-in Latch <sup>1</sup>	V3LD
Display mount	MOUNT-V23

<sup>1</sup> Sold only as a separate part.

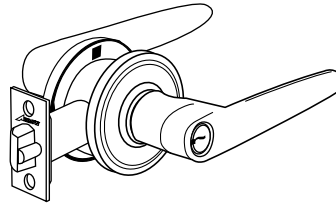

**DISCONTINUED. LIMITED AVAILABILITY THROUGH DISTRIBUTION ONLY.  
CONTACT CUSTOMER SERVICE FOR ADDITIONAL INFORMATION.**

**Features**

Certification	BHMA A156.2, Series 4000, Grade 2
Door Thickness	Fits 1-3/8" - 1-3/4", factory set for 1-3/4"
Strike	Standard: Full lip 1-5/8" x 2-1/4"; alternate strikes available
Latch	Standard: 2-3/8" - 2-3/4" adj. backset, 1" front; alternate latches available
Cylinder	6-pin, solid brass, 2 brass keys
Handing	Non-handed
Case Quantity	20
Average Case Weight	38 lbs.
Warranty	5 years

Available Finishes	Arrow Code	BHMA Code	U.S. Code
Bright Brass	03	605	US3
Satin Brass	04	606	US4
Antique Brass	05A	609	US5
Satin Nickel	15	619	US15
Bright Chromium Plated	26	625	US26
Satin Chromium Plated	26D	626	US26D

**How to Order**

Function	<b>CL11</b>
Trim	CL11-SC
Finish	CL11-SC-26D
Strike	CL11-SC-26D-502
Latch	CL11-SC-26D-502-511
Keying	CL11-SC-26D-502-511-KD-AR

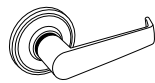

SC



LC¹

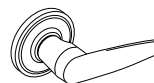

VC



OC¹

Function	Description	SC	VC	LC, OC
CL01	Passage	\$83.00	\$81.00	\$77.00
CL02	Privacy	\$90.00	\$88.00	\$84.00
CL04	Patio	\$89.00	\$87.00	\$83.00
CL08	Single Dummy	\$39.00	\$38.00	\$36.00
CL11	Entrance	\$117.00	\$115.00	\$111.00
CL12	Storeroom	\$117.00	\$115.00	\$111.00

¹ Handing required for LC & OC trim designs.



## CL Series Options & Parts

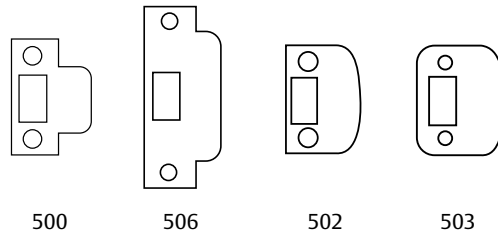

**DISCONTINUED. LIMITED AVAILABILITY THROUGH DISTRIBUTION ONLY.  
CONTACT CUSTOMER SERVICE FOR ADDITIONAL INFORMATION.**

Strike Options	Description	Specify	Price Add
T-Strike	1-1/8" x 2-3/4", 1-1/4" lip, square corner	500	No Add
ANSI	1-1/4" x 4-7/8", 1-1/4" lip, square corner	506	\$9.14
Full Lip D-Type	1-3/4" x 2-1/4", 1-1/4" lip, square corner	502	Standard
Radius D-Type	1-3/4" x 2-1/4", 1-1/4" lip, 1/4" radius corner	503	No Add

Latch Options	Description	Spring Latch	Dead Latch	Price Add
2-3/8" - 2-3/4"	Includes 3 faceplates	501	511	Standard
Adjustable Backset	Drive-in	505	515	No Add

Keying & Cylinder Options	Specify	Price Add
Keyed alike in four (quantity permitting otherwise KD)	KA4	Standard
Keyed different	KD	No Add
O-Bitted	OB	No Add

Strikes	Description	Part No.	Price
T-Strike	1-1/8" x 2-3/4", 1-1/4" Lip, Square Corner	500	\$5.76
ANSI	1-1/4" x 4-7/8", 1-1/4" Lip, Square Corner	506	\$14.90
Full Lip D-Type	1-3/4" x 2-1/4", 1-1/4" Lip, Square Corner	502	\$5.76
Radius D-Type	1-3/4" x 2-1/4", 1-1/4" Lip, 1/4" Radius Corner	503	\$5.76

Latches	Description	Spring Latch	Dead Latch	Price
2-3/8" - 2-3/4"	Includes 3 faceplates	501	511	\$14.90
Adjustable Backset	Drive-in	505	515	\$14.90

Cylinder & Related	Part No.	Price
Standard cylinder for CL Series	100YC	\$29.15
Standard tailpiece for CL Series	10CL-44	\$2.95



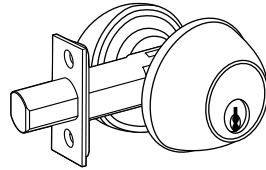

**DISCONTINUED. LIMITED AVAILABILITY THROUGH DISTRIBUTION ONLY.  
CONTACT CUSTOMER SERVICE FOR ADDITIONAL INFORMATION.**

**Features**

Certification	ANSI A156.5, Grade 2, UL Listed
Door Thickness	Fits 1-3/8" to 1-3/4", factory set to 1-3/4"
Strike	2-3/4" x 1-1/8", round corners
Bolt	2-3/8" - 2-3/4" adjustable backset, 1" front, includes spacer for 1-1/8" prep
Cylinder	6-pin, solid brass, keyed alike in 4, CS keyway, includes 2 brass keys
Handing	Non-handed
Case Quantity	12 per case
Average Case Weight	DB61-22lbs. / DB62-27lbs.
Warranty	1 year

Available Finishes	Arrow Code	BHMA Code	U.S. Code
Bright Brass	03	605	US3
Dark Oxide Satin Bronze, Clear Coated	10BP	614	US10BL
Satin Stainless Steel	32D	630	US32D

**How to Order**

Function	<b>DB61</b>
Finish	<b>DB61-32D</b>
Strike	<b>DB61-32D-394</b>
Latch	<b>DB61-32D-394-157</b>
Keying	<b>DB61-32D-394-157-KA4-CS</b>

Function	Description	32D	03, 10B
DB61	Cylinder x Thumbturn	\$42.80	\$50.44
DB62	Double Cylinder	\$60.90	\$68.56



## DC300 Series Door Closer

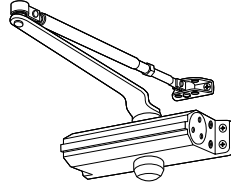

**DISCONTINUED. LIMITED AVAILABILITY THROUGH DISTRIBUTION ONLY.  
CONTACT CUSTOMER SERVICE FOR ADDITIONAL INFORMATION.**

<b>DC300 Surface Applied Door Closers</b>		
	<b>Part No.</b>	<b>Price</b>
Size 1-4, std NHO arm, PA bracket	DC314	\$163.00
Size 1-4, std HO arm, PA bracket	DC314-1	\$192.00
Size 2-5, std NHO arm, PA bracket	DC325	\$163.00
Size 2-5, std HO arm, PA bracket	DC325-1	\$192.00
<b>Parts &amp; Accessories</b>		
	<b>Part No.</b>	<b>Price</b>
Full plastic cover, screw pack, 1-3/8" thru-bolts	DC3CVR	\$26.58
Thru-bolts 2"	DC500TB2	\$6.77

- Packed 6 per case.
- Specify AL or DBZ finish.

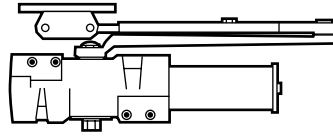

## DC500 Series Door Closer

Discontinued  
Products

**DISCONTINUED. LIMITED AVAILABILITY THROUGH DISTRIBUTION ONLY.  
CONTACT CUSTOMER SERVICE FOR ADDITIONAL INFORMATION.**

### Features

Certification	ANSI A156.4 and ANSI ICC A117.1 Grade 1
Size	1 to 6
Cover	Included: full plastic
Thru-Bolts	Included: 1-3/4"
Case Quantity	4
Average Case Weight	51.4 lbs.
Warranty	10 years

Description	Part No.	Price
Standard arm, non-hold open, with PA bracket	DC516	\$257.00
Standard arm, hold open, with PA bracket	DC516-1	\$312.00
Heavy-duty dead stop arm, non-hold open	DC516-2	\$310.00
Heavy-duty dead stop arm, hold open	DC516-3	\$341.00

Parts & Accessories	Part No.	Price
Full Plastic Cover	DC500CV	\$25.08
Drop Plate - Regular	DC500DP	\$24.33
Drop Plate - Parallel Arm	DC500DP1	\$26.84
Drop Plate - Top Jamb, Flush Ceiling	DC500DP3	\$24.33
Drop Plate - Top Jamb	DC500DP2	\$24.33
Thru-bolts 1-3/4"	DC500TB1	\$6.77
Thru-bolts 1-3/8"	DC500TB3	\$6.77
Thru-bolts 2-1/4"	DC500TB2	\$6.77
Standard Screw Pack	DC500SP2	\$10.81
Standard Non-Hold Open Arm	DC500A	\$87.85
Standard Hold Open Arm	DC500A1	\$101.00
Heavy-Duty Dead Stop Arm Non-Hold Open	DC500A2	\$106.00
Heavy-Duty Dead Stop Arm Hold Open	DC500A3	\$119.00
Heavy-Duty Cushion Arm Non-Hold Open	DC500A4	\$138.00
Heavy-Duty Cushion Arm Hold Open	DC500A5	\$156.00

- Specify AL or DBZ finish.



# Alarmed Hardware

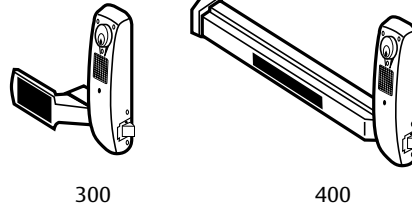

300

400

**DISCONTINUED. LIMITED AVAILABILITY THROUGH DISTRIBUTION ONLY.  
CONTACT CUSTOMER SERVICE FOR ADDITIONAL INFORMATION.**

Alarmed Hardware	Part. No.	AL, BRZ, RD	10,10B,26,26D
Paddle type	330	\$762.00	\$847.00
Push bar type	430	\$894.00	\$1,082.00
Fire-rated push bar type	F430	\$1,039.00	\$1,227.00

Alarm Options	Specify	Price Add
Remote monitor (wiring for remote monitor and power)	RM	\$55.00
Remote power (power supply not included)	RP	\$55.00
Continuous alarm	CA	\$55.00
Automatic rearming	AR	\$55.00

- Specify LR or RR handing.
- All units designed to accept outside cylinder operation. Supplied less cylinder.
- All units include low battery alert feature.
- 300 Series packed 8 per case.
- 400 Series packed 1 per case.

300 & 400 Series Parts	Part No.	Price
Roller/micro switch (red & yellow wires)	32-7044	\$87.45
On/off switch	32-7062	\$52.85
Circuit board (specify x20 or x30)	32-7070	\$287.00
Electronics & painted cover for x30	32-7035	\$468.00
Battery snap assembly	32-7043	\$6.02
Paddle & chassis for 300 Series	32-7065	\$226.00
Active chassis for 400 Series	32-7171	\$121.00
End cap mounting bracket for 400 Series	68-2141	\$21.15
End cap for 400 Series	32-7027	\$21.15
End cap for F400 Series	32-7080	\$21.15
Dogging key	97-0001	\$9.81
Paddle for 300 Series	32-1224	\$94.00



The ASSA ABLOY Group is the global leader in access solutions. Every day, we help billions of people experience a more open world.

ASSA ABLOY Opening Solutions leads the development within door openings and products for access solutions in homes, businesses and institutions. Our offering includes doors, frames, door and window hardware, locks, perimeter fencing, access control and service.



**ASSA ABLOY**

**ARROW USA**

Phone: 1-800-839-3157

Fax: 1-800-421-6615

**ARROW CANADA**

Phone: 1-800-461-3007

Fax: 1-800-461-8989

Visit us at our Website:

[www.arrowlock.com](http://www.arrowlock.com)

For more information regarding Arrow locksets, exit devices, door closers and key systems, contact your authorized Arrow distributor.