

**A: GENERAL INFORMATION**

Terms and Conditions	A:1
General Information	A:3
Weights and Measurements	A:12
Order Forms	A:15

**B: NEW PRODUCTS**

Obsidian	B:1
Kevo 2nd Gen	B:3
Kevo Convert	B:5
Premis	B:7
San Clemente	B:9
Camino	B:11
Contemporary Interconnect	B:13
Amador	B:15
660CRR	B:17
Uptown & Downtown Deadbolts	B:19
Microban	B:21
SmartCode 913 CNT	B:23

**C: KWIKSET SIGNATURE SERIES**

Handlesets	C:2
Levers	C:8
Knobs	C:11
Deadbolts	C:13
Specifications	C:14

**D: KWIKSET**

Handlesets	D:2
Levers	D:3
Knobs	D:5
Deadbolts	D:6
Combo Packs	D:6
Specifications	D:7

**E: ELECTRONIC LOCKS**

Kevo 2nd Gen	E:1
Smartcode	E:3
Home Connect	E:4
Specifications	E:5

**F: LIGHT COMMERCIAL**

Residential/Light Commercial	F:1
Specifications	F:2
Key Control Deadbolt	F:3
Specifications	F:4

**G: ACCESSORIES**

Bath Hardware	G:1
Pocket Door Locks	G:3
SmartKey Padlocks	G:3
Trim and Installation Aids	G:4

**H: SERVICE PARTS**

Keys	H:1
Pin & Tumbler	H:2
SmartKey	H:6
Key Control	H:7
Latches	H:8
Strikes	H:11
Screw Packs	H:14
Miscellaneous	H:18
Electronics	H:20



## TERMS AND CONDITIONS OF SALE

Standard terms are 2% prompt payment discount for payment within 25 days from date of invoice; net 30 days from the date of invoice. Kwikset® reserves the right to charge and recover on invoices which are not paid within the above terms, a service charge of 1-1/2% a month for each month or fraction thereof during which the invoice remains unpaid, said service charge, however, not to exceed the highest applicable legal rate of interest. All orders, whether solicited or written by our sales representatives or forwarded by our customers are deemed to be mere offers to purchase in accordance with these Terms and Conditions of Sale until actually accepted by us at our home office in Lake Forest, CA. We reserve the right to refuse any order as well as the right to sell or not sell to any firm at our sole discretion. The acceptance of an order is expressly made conditional upon your assent to these Terms and Conditions of Sale. We object to the inclusion of any different or additional terms or conditions, even if the same are included in your order, a contract of sale will result upon the Terms and Conditions of Sale stated herein only. Prices reflected in this book apply to Wholesale customers only.

All sales are final.

## PRICES

Pricing based on full-case quantities only; orders for less than full case will be automatically adjusted up to the next full-case quantity. All prices are subject to change without notice and are not guaranteed. All taxes, duties or other charges are the responsibility of the customer.

## CLAIMS

Price claims must be submitted in writing to Kwikset, 19701 Da Vinci, Lake Forest, CA 92610 within 30 days from the date of invoice.

## CHANGES OR CANCELLATIONS

Beyond 5 working days of our acknowledgement date no changes can be made. Additions to an order will be handled as a separate order and must meet applicable minimum order requirements. Order cancellation on regular stock items only, or any portion thereof is allowed only upon prior written consent from Kwikset, and the payment of cancellation charges deemed appropriate.

## MINIMUM CHARGE

No order will be invoiced for less than \$100.00 net plus shipping charges except for lock accessory parts.

## MINIMUM ANNUAL SALES VOLUME

The company reserves the right to discontinue direct sales to any customer who does not meet the minimum annual sales volume requirement. The current annual requirement is \$50,000.00. Your annual purchases are determined by accepted, non-cancelled, and shipped orders received during each calendar year. Kwikset reserves the right to change any or all minimum annual sales volume requirements at any time. Any customer who does not meet the annual sales volume requirements may continue to purchase Kwikset products through a Kwikset distributor.

## RETURNS

Defective merchandise returned to our factories requires prior written authorization from a Kwikset Sales Rep or the Sales Office. A factory return authorization must accompany the returned shipment. The return authorization must include an itemized listing of the merchandise and an explanation stating the reason for return.

There will be a 20% product restocking fee on all returned merchandise.

## FREIGHT

All goods are invoiced FOB to our factory. Upon delivery of shipments to the carrier, title to, and the risk of loss or damage in transit for such shipments, passes to our customer. Kwikset's standard policy is to pay freight charges on all orders over \$1,000.00 net invoice value to a single destination in the continental U.S., by carrier and route of our choice. Shipments less than these quantities will not be shipped on a prepaid basis. If higher freight charges are incurred from customers specifying a carrier or route of their choice the additional cost will be added to that customer's invoice.

## PRODUCT WARRANTY

Warranties cover the original residential user of Kwikset Products against defects in material and workmanship as long as the original user occupies the residential premises upon which the Product was originally installed. This warranty DOES NOT COVER abused or misused products or non-commercial products used in commercial applications. Upon return of a defective product to Kwikset Corporation, Kwikset shall either replace the product or refund the purchase price, at our discretion. If a covered defect occurs, call 1-800-327-LOCK (5625) in the U.S. and Canada or return it to Kwikset Corporation, Consumer Services, 19701 DaVinci, Lake Forest, California 92610. A finish deterioration occurring from the use of paints, solvents, or other chemicals is not a defect in the finish and is not covered by this warranty. Kwikset is not liable for incidental or consequential damages. Some states do not allow the exclusion or limitation of incidental or consequential damages, so the above exclusion may not apply to you. This warranty gives you specific legal rights and you may also have other rights that vary from state to state.

## PATENT INDEMNITY

We agree to defend any suit or proceeding brought against our customer so far as based on claim that our products, or any part thereof, made solely to our specifications and furnished to our customer constitute an infringement of any U.S. patent, if notified promptly in writing and given authority, information and assistance at our expense for the defense of same, and we shall pay all damages and costs awarded therein against our customer. In case our products, or any part thereof, is in such suit held to constitute infringement and their use is enjoined, we will, at our expense and discretion, either procure for our customer the right to continue using the products or replace same with non-infringing products, or modify them so they become non-infringing, or remove such products and refund the purchase price (less depreciation, prorated from the purchase date). The foregoing states our entire liability for patent infringement by our products or any part thereof.

## INTELLECTUAL PROPERTY

No person or entity may sell, distribute, advertise, market or promote Kwikset branded products distributed by Kwikset Corporation ("Kwikset"), Spectrum Brands Hardware Home Improvement Division, without prior authorization from Kwikset. Customers of Kwikset who are authorized to sell Kwikset branded products are referred to herein as "Customers."

The Kwikset brand and all Kwikset trademarks, trade names, product depictions, colors, graphics or logos, whether or not registered or otherwise protected (the "Marks"), remain the sole and exclusive property of Kwikset and nothing arising out of the relationship between Kwikset and any Customer conveys to Customer any ownership rights in the Marks. Customer may use the Marks and then only in the sale or promotion of authentic Kwikset products in compliance with the terms of this policy. The Marks must be used exactly in the form provided and in conformity with all Kwikset trademark usage policies or guidelines, including, but not limited to, those relating to shape, color match and imprint quality. Any proposed deviation must be approved in writing by Kwikset prior to use. The Marks may not be used in or as part of any Customer domain name on the Internet. Prior to any use of the Marks on goods or services, Customer must submit samples for Kwikset's approval.

Additionally, no Customer may use product depictions, graphics, logos or text relating to Kwikset products that have not been provided by Kwikset in connection with the advertising, promotion or sale of Kwikset products without Kwikset's prior review and written approval of each such use. The Marks may not be used in or as part of any reseller or other third party (i) domain name or VRL on the Internet, (ii) trademark or service mark, or (iii) company or trade name. Any action on the part of a Customer that violates the terms of this policy or otherwise impairs the value of or goodwill associated with the Marks or is otherwise not in conformity with Kwikset's standards may result in the suspension or termination of the Customer's authorization or any other remedy permitted by law.

Kwikset grants to each of its Customers limited, non-transferable, non-sublicenseable licenses of the patents relating to the Kwikset products that the Customer is authorized to sell and of the copyrights in any packaging or other written materials included therewith or related thereto. Said patent and copyright licenses are solely to sell such Kwikset products covered by such patents and to which such copyrights relate only to end-users and other Customers in compliance with the terms of this document. The sale of such patented Kwikset products and the sale or use of such copyrighted materials by a Customer that violate the terms of this document exceed the scope of the licenses herein granted to the Customer and may constitute patent and/or copyright infringement.

## **STANDARDS**

Kwikset meets or exceeds the testing requirements specified for each product grade or rating.

- American National Standards Institute (ANSI)
- Builders Hardware Manufacturers Association (BHMA)
- Underwriters Laboratories, Inc. (UL)
- Americans with Disabilities Act (ADA)

## **MISCELLANEOUS**

Substitution of non-Kwikset components/parts, and any alteration or modification of factory parts, and other lock manufacturer's parts may result in door hardware which does not function properly or will fail and will void all warranties. Orders not specified with keying requirements will be shipped Keyed Differently (KD). Orders with keying requirements of K10 or more must have a "Letter of Release" on file with Kwikset stating that Kwikset Corporation will not be held liable for cost and expense arising from any loss or damage to property utilizing Kwikset products where 10 or more locks have been keyed alike. Contact your Sales Office account representative for a copy of the release form. Kwikset reserves the right to revise or modify products, product information, or pricing without notice. Product specifications and pricing reflect available information at the time of printing. Kwikset is not responsible for typographic or printing errors.

**ORDER CODE BREAKOUT**

Quantity	Specifies Quantity
Function & Style	Specifies Model and Function
Rose Design	Specifies Designer Rose
Handing	Handing Right or Left
Finish	Exterior/Interior
Keying	Special Keying
Code	Keying Code
Latch	Specifies Latch
Strike	Indicates Strike
Key Alike Qty	Keyed Alike

**Example:** "I would like to order 12 SmartKey Commonwealth levers, satin nickel finish, round corner latch & strike, 3 keyed alike" Written as:  
12-740CHL 15 SMT RCAL RCS K3.

NOTE: All handlesets ordered LIP only.

**UNDERWRITERS LABORATORIES LISTED LOCKSETS**



To meet Underwriters Laboratories' fire rating requirements UL listed locksets, UL listed latches, and UL listed strikes must be used together.

**AMERICAN WITH DISABILITIES ACT**



Products displaying this symbol comply with the Americans with Disabilities Act of 1990.

**HOW TO ORDER 20MIN UL LOCKS**

FD = 20 minute UL designation

**Example:** "I would like to order 12 passage Tustin levers with round corner latch and strike with 20 minute UL in Satin Nickel"  
12-720TNL 15 RCALFD RCS.

NOTE: The latch configuration is not available with FD. There is a \$2.50 list price upcharge for 20 minute UL.

**KEYING**

Code	Option
KD	Keyed Differently
K2, K3	Keyed Alike (2 Locksets, 3 Locksets)
MK	Master Keyed
PK	Builder (Protecto) Keyed
GMK	Grand Master Keyed
PMK	Builder (Protecto) Master Keyed
MAIS	Maison Keying
SEQ	Sequential Construction Keying
KBOX	Keys in One Box
SMT	SmartKey

NOTE: There is a \$2.55 upcharge per lock for specialty keying.

**BACKSET**

Backset is the distance from center edge of door to center of the 2-1/8" (54mm) diameter hole, 2-3/8" or 2-3/4" in most cases.

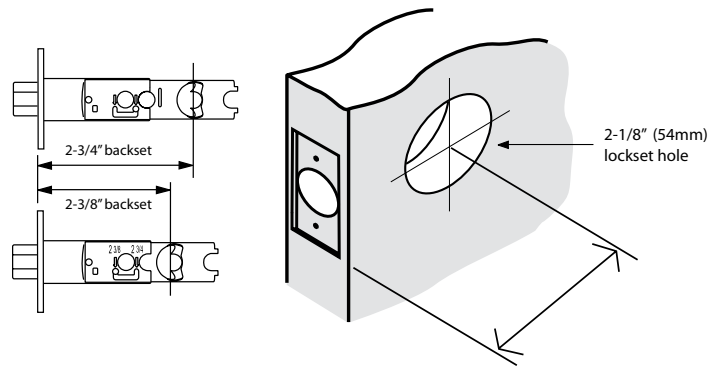

Model	Function
154/200/407/420/720/721/725	Passage/Hall/Closet
155/300/408/430/730/733/735	Privacy/Bed/Bath
334/335	Round Pocket Door Lock
400/401/438/740/741/756	Entry
156/405/406/409/413	Lever Keyed Entry
450/462/412/439/755/781	Storeroom/Vestibule
157/488/788	Half Dummy Trim, Surface Mounted
502/505/506/507/508	Interconnect
553/687/800/818	Single Cylinder Handleset
689/801	Double Cylinder Handleset
699/802/819	Dummy Handleset
814/815	Handle Only
598	Single Cylinder Gatelatch
599	Double Cylinder Gatelatch
604/605/606	Interior Pack for Kwikset Handlesets
158/258/660/780/782/980/982/816/817	Single Cylinder Deadbolts
159/665/784/785/984/985	Double Cylinder Deadbolts
910/912/914/916	Home Connect Deadbolt and Lever
907/909/911/913/915/919	Electronic Single Cylinder Deadbolt and Lever
925	Bluetooth Enabled Deadbolt
953	Keyless Touchscreen Deadbolt
966/967/968/971/973/974/976/977	Interior Pack for Kwikset Signature Series Handleset
978/979	Interior Pack for Montara Handleset

### HANDING

To determine the handing of a door face the OUTSIDE of the door. If the hinge is on the left side of the door, the door is left handed (LH). If the hinge is on the right side of the door, the door is right handed (RH).

**NOTE:** Handing required for dummy levers and interior packs with levers when lever design is not symmetric.

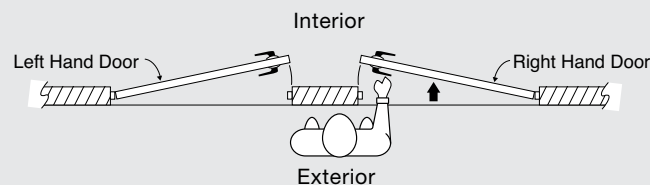

Finish	Description	ANSI/BHMA	Latch	Description
3	Polished Brass	605	WFL	Wide Face Latch 2-1/4" x 1-1/8"
L03	Lifetime Polished Brass	605E	RCAL	Round Corner Adjustable Latch
5	Antique Brass	609	6AL	6-Way Adjustable Latch. All Parts Loose
11P	Venetian Bronze	---	SCAL	Square Corner Adjustable Latch
15	Satin Nickel	619	RFAL	Round Face Adjustable Latch
15A	Antique Nickel	620	RCAL FD*	Round Corner Adjustable 20 Minute UL
26	Polished Chrome	625	SCAL FD*	Square Corner Adjustable 20 Minute UL
26D	Satin Chrome	626	RFAL FD*	Round Adjustable 20 Minute UL
514	Iron Black	---		



**\*NOTE:** List charge for 20 minute UL is \$2.50

**KWIKSET SIGNATURE  
SERIES w/ BHMA**

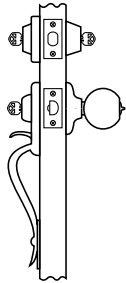
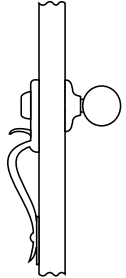

HANDLESETS	Function Name	Description	KWIKSET w/ BHMA	SERIES w/ BHMA
	<p>Handleset with Single Cylinder Deadbolt</p>	<p>Latch bolt operated by thumb piece outside and grip inside. Deadbolt operated by key outside and thumb turn inside.</p>	<p>687</p>	<p>800, 818</p>
	<p>Handleset with Double Cylinder Deadbolt</p>	<p>Latch bolt operated by thumb piece outside and grip inside. Deadbolt operated by key both sides.</p>	<p>689</p>	<p>801</p>
	<p>Dummy Handleset with Dummy Deadbolt</p>	<p>Handle and grip act as a pull only. For inactive leaf of double doors. No operation.</p>	<p>699</p>	<p>802, 819</p>
	<p>Two Point Locking Handleset with Single Cylinder Deadbolt</p>	<p>Latch bolt operated by thumb piece outside and grip inside, except when both are locked by key outside or turn button inside. Deadbolt operated by key outside or thumb turn inside.</p>	<p>N/A</p>	<p>553 F94</p>

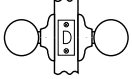
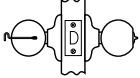
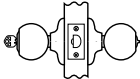
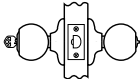
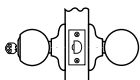
HANDLESETS	Function Name	Description	KWIKSET w/ BHMA	KWIKSET SIGNATURE SERIES w/ BHMA
	Two Point Locking Handleset with Double Cylinder Deadbolt	Latch bolt operated by thumb piece outside and grip inside, except when both are locked by key outside or turn button inside. Deadbolt operated by key both sides.	N/A	554
	Handleset with Knob or Lever	Latch bolt operated by thumb piece outside and grip inside.	899	814/815





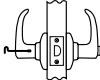
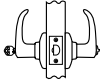
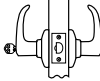
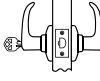



KNOBS	Function Name	Description	KWIKSET w/ BHMA	KWIKSET SIGNATURE
				SERIES w/ BHMA
	Passage/Hall/Closet	Both knobs always free.	200 F75	720/725UL F75
	Privacy/Bed/Bath	Both knobs locked or unlocked by turn button inside. Outside knob unlocked by emergency key.	300 F76	730/735UL F76
	Entry	Both knobs locked or unlocked by key outside or turn button inside.	400 F82	740/745UL F82
	Entry, Free Interior	Outside locked or unlocked by key outside or turn button inside. Inside always free.	401 F81	741/746UL F81
	Storeroom/Vestibule	Outside unlocked only while key is turned. Inside always free.	450 F86	750/755UL F86
	Half Dummy Trim, Surface Mounted	For doors where only a pull is required. No operation.	488	788

NOTE: BHMA code in italics. Optional UL 1/3 hour rating for all functions.

LEVERS	Function Name	Description	KWIKSET w/ BHMA	KWIKSET SIGNATURE SERIES w/ BHMA
	Passage/Hall/Closet	Both levers always free.	200/407/420UL F75	154/720/725/725UL F75
	Privacy/Bed/Bath	Both levers locked or unlocked by turn button inside. Outside lever unlocked by emergency key.	300/408UL/430UL F76	155/730/735UL F76
	Keyed Entry Lever	Both levers locked or unlocked by key outside or turn or push button inside.	401/405/406UL F82	156/740/745/756UL F82
	Entry, Free Interior	Outside locked or unlocked by key outside or turn button inside. Inside always free.	401/406/413UL F81	741/746UL/911 F81
	Storeroom/Vestibule	Outside unlocked only while key is turned. Inside always free.	439/450/462/412UL F86	750/755UL/781 F86
	Half Dummy Trim, Surface Mounted	For doors where only a pull is required. No operation.	488	788/157

NOTE: BHMA code in italics. Optional UL 1/3 hour rating for all functions.

**KWIKSET SIGNATURE  
SERIES w/ BHMA**

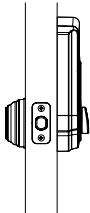
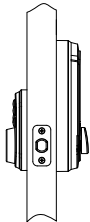
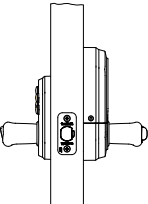
<b>DEADBOLTS</b>	<b>Function Name</b>	<b>Description</b>	<b>KWIKSET w/ BHMA</b>	<b>KWIKSET SIGNATURE SERIES w/ BHMA</b>
	Single Cylinder	Deadbolt operated by key outside and thumb turn inside.	660 E0153	980/982UL E0151 780/782UL/909 E0152 816/817UL E0152 158/258/913/925/997 E0142
	Double Cylinder	Deadbolt operated by key both sides.	665/E0143	985/984UL E0141 785/784UL E0142 996 159 E0152
	Thumb Turn Only	Deadbolt operated by thumb turn one side. No trim on exterior.	663 E0193	N/A
	Conversion Kit	Converts 663 to 667 when door is bored through.	664	N/A
	Thumb Turn x Plate	Deadbolt operated by thumb turn on interior. Blank plate on exterior.	667/677UL E01113	N/A
	Single Cylinder Gatelatch	Deadbolt operated by key outside and thumb turn inside.	N/A	598
	Double Cylinder Gatelatch	Deadbolt operated by key both sides.	N/A	599
<b>ELECTRONIC DEADBOLTS</b>	<b>Function Name</b>	<b>Description</b>	<b>KWIKSET w/ BHMA</b>	<b>KWIKSET SIGNATURE SERIES w/ BHMA</b>
	Kevo®	Deadbolt operated by key outside or bluetooth enabled device	N/A	925 E0152
	SmartCode™ Deadbolt	Deadbolt operated by key outside or electronic keypad and thumb turn inside.	N/A	909/913/915/919 E0152
	SmartCode™ Lever	Keyed lever operated by key outside or electronic keypad and thumb turn inside.	N/A	911 F81

**NOTE:** BHMA code in italics

**ROUND POCKET**

**DOOR LOCK**

**KWIKSET SIGNATURE**

**Function Name      Description      KWIKSET w/ BHMA      SERIES w/ BHMA**

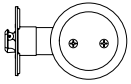

Passage

Pocket door lock always free.

334

N/A

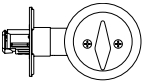

Privacy

Pocket door lock operated by thumb turn.

335

N/A

**LIGHT COMMERCIAL**

**LEVER**

**LIGHT COMMERCIAL**

**Function Name      Description      KWIKSET w/ BHMA**

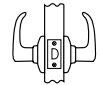

Passage/Hall/Closet

Both levers always free.

407/720/721/725UL F75

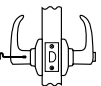

Privacy/Bed/Bath

Both levers locked or unlocked by ADA turn button inside. Outside lever unlocked by emergency key.

408/730/733/735UL F76

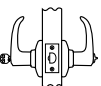

Entry

Both levers locked or unlocked by key outside or ADA turn button inside.

409/410/438/740/745UL/756 F82

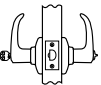

Entry, Free Interior

Outside locked or unlocked by key outside or turn button inside. Inside always free.

401/406/413/741/746UL F81

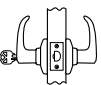

Storeroom/Vestibule

Outside unlocked only while key is turned. Inside always free.

412/439/750/755UL/781 F86

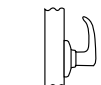



Half Dummy Trim, Surface Mounted

For doors where only a pull is required. No operation.

788

NOTE: BHMA code in italics

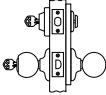
**METAL**

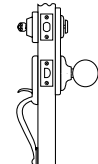
<b>INTERCONNECT</b>	<b>Function Name</b>	<b>Description</b>	<b>METAL INTERCONNECT Model w/BHMA</b>
	Deadlock Latch	Operated by grip either side except when locked by key outside and thumb turn inside. Deadbolt operated by key outside and thumb turn inside. Inside grip simultaneously retracts dead latch and deadbolt latch.	505/506UL F97
	Plain Latch	Operated by grip either side. Deadbolt operated by key outside and thumb turn inside. Inside grip simultaneously retracts plain latch and deadbolt latch.	508/507UL F96
	Interior Assembly Only	Grip inside simultaneously retracts plain latch and deadbolt latch when matched with handleset on outside.	502

NOTE: BHMA code in italics

BOX PACK	Unit					Master Case			
	Quantity	Length (in.)	Width (in.)	Height (in.)	Weight (lbs.)	Quantity	Length (in.)	Width (in.)	Height (in.)
<b>Kwikset Signature Series</b>									
<b>Deadbolts</b>									
780 Single Cylinder	1	4.6730	3.9230	3.0720	2.2500	12	12.8750	12.5000	5.3125
785 Double Cylinder	1	4.6730	3.9230	3.0720	2.7500	12	12.8750	12.5000	5.3125
816 Key Control	1	4.6730	3.9230	3.0720	2.2500	12	12.8750	12.5000	5.3125
980 Single Cylinder	1	4.6730	3.9230	3.0720	2.2500	12	12.8750	12.5000	5.3125
985 Double Cylinder	1	4.6730	3.9230	3.0720	2.7500	12	12.8750	12.5000	5.3125
158 Single Cylinder	1	4.6730	3.9230	3.0720	2.2500	12	12.8750	12.5000	5.3125
159 Single Cylinder	1	4.6730	3.9230	3.0720	2.7500	12	12.8750	12.5000	5.3125
258 Single Cylinder	1	4.81	4.06	3.13	1.76	12	13.37	12.9	6.21
<b>Electronic Deadbolts/Levers</b>									
907 Powerbolt	1	5.51	3.54	9.29	2.93	2	5.75	7.87	10.16
909 / 910 SmartCode	1	5.5	3.5	10	2.88	2	7.6	6	10.5
911 / 912 SmartCode Lever	1	3.5	6	10	61	2	7	12.5	10.4
913 / 914 SmartCode	1	5.5	3.5	10	2.88	2	7.6	6	10.5
915 / 916 / 919 SmartCode	1	3.5	5.38	9.88	3.14	2	10.50	7.75	5.94
925 Kevo	1	3.63	5.75	10.38	3.5	1	11.63	4	6.25
926 Kevo Fob	4	6	1	3	0.5	4	6	1	3
<b>Handlesets</b>									
553 Single Cylinder	1	15.9380	7.1250	4.0000	6.2500	6	15.0000	12.1250	16.6255
554 Double Cylinder	1	15.9380	7.1250	4.0000	6.7500	6	15.0000	12.1250	16.6255
800 AUH Austin	1	15.9380	7.1250	4.0000	7.0000	6	15.0000	12.1250	16.6255
801 AUH Austin	1	15.9380	7.1250	4.0000	7.5000	6	15.0000	12.1250	16.6255
802 AUH Austin	1	15.9380	7.1250	4.0000	6.5000	6	15.0000	12.1250	16.6255
800ADH Ashfield, 800AVH Avalon	1	15.9380	7.1250	4.0000	7.0000	6	15.0000	12.1250	16.6255
801ADH Ashfield, 801AVH Avalon	1	15.9380	7.1250	4.0000	7.5000	6	15.0000	12.1250	16.6255
802ADH Ashfield, 802AVH Avalon	1	15.9380	7.1250	4.0000	6.5000	6	15.0000	12.1250	16.6255
800AN Arlington	1	15.9380	7.1250	4.0000	7.0000	6	15.0000	12.1250	16.6255
801AN Arlington	1	15.9380	7.1250	4.0000	7.5000	6	15.0000	12.1250	16.6255
802AN Arlington	1	15.9380	7.1250	4.0000	6.5000	6	15.0000	12.1250	16.6255
800AT Amherst	1	19.9380	7.6250	4.0000	8.9000	4	20.5000	16.0000	8.3875
801AT Amherst	1	19.9380	7.6250	4.0000	9.9000	4	20.5000	16.0000	8.3875
802AT Amherst	1	19.9380	7.6250	4.0000	6.9000	4	20.5000	16.0000	8.3875
800CE Chelsea	1	15.9380	7.1250	4.0000	6.0000	6	15.0000	12.1250	16.6255
801CE Chelsea	1	15.9380	7.1250	4.0000	6.5000	6	15.0000	12.1250	16.6255
802CE Chelsea	1	15.9380	7.1250	4.0000	5.5000	6	15.0000	12.1250	16.6255
800HE Hawthorne	1	15.9380	7.1250	4.0000	7.0000	4	16.4380	15.9380	7.8125
801HE Hawthorne	1	15.9380	7.1250	4.0000	8.0000	4	16.4380	15.9380	7.8125
802HE Hawthorne	1	15.9380	7.1250	4.0000	5.0000	4	16.4380	15.9380	7.8125
800SE Shelburne	1	15.9380	7.1250	4.0000	7.9000	4	16.4380	15.9380	7.8125
801SE Shelburne	1	15.9380	7.1250	4.0000	8.9000	4	16.4380	15.9380	7.8125
802SE Shelburne	1	15.9380	7.1250	4.0000	5.9000	4	16.4380	15.9380	7.8125
800 Tavaris	1	15.9380	7.1250	4.0000	8.0000	4	16.4380	16.6200	8.3800
801 Tavaris	1	15.9380	7.1250	4.0000	8.2500	4	16.4380	16.6200	8.3800
802 Tavaris	1	15.9380	7.1250	4.0000	8.0000	4	16.4380	16.6200	8.3800
966 Single Cylinder	1	2.7	3.7	4.30	2.25	12	15.20	12.5	7
967 Double Cylinder	1	2.7	3.7	4.30	2.25	12	15.20	12.5	7
968 Dummy	1	2.7	3.7	4.30	2.25	12	15.20	12.5	7
978 Single Cylinder	1	2.7	3.7	4.30	2.25	12	15.20	12.5	7
979 Double Cylinder	1	2.7	3.7	4.30	2.25	12	15.20	12.5	7

BOX PACK	Unit					Master Case			
	Quantity	Length (in.)	Width (in.)	Height (in.)	Weight (lbs.)	Quantity	Length (in.)	Width (in.)	Height (in.)
<b>Kwikset Signature Series Continued</b>									
<b>Knobs</b>									
720 Passage	1	8.1730	3.9230	2.7840	2.0000	12/30	12.3750	11.5000	8.8125
730 Privacy	1	8.1730	3.9230	2.7840	2.0000	12/30	12.3750	11.5000	8.8125
740 Entry	1	8.1730	3.9230	2.7840	2.3300	12/30	12.3750	11.5000	8.8125
788 Dummy	1	3.2360	2.7980	3.0100	0.3500	20	14.8750	12.5000	3.9375
<b>Levers</b>									
154/720 Passage	1	7.8750	6.1250	3.1875	2.4200	12/20	19.7500	12.8750	8.5625
155/730 Privacy	1	7.8750	6.1250	3.1875	2.4200	12/20	19.7500	12.8750	8.5625
156/740 Entry	1	7.8750	6.1250	3.1875	2.4200	12/20	19.7500	12.8750	8.5625
157/788 Dummy	1	5.8610	3.1100	2.8220	0.4500	20	15.8750	12.1250	6.6245
720 LL, TNL	1	6.625	5.75	3.0	1.65	20	24	15.50	6.70
730 LL, TNL	1	6.625	5.75	3.0	1.70	20	24	15.50	6.85
740 LL, TNL	1	6.625	5.75	3.0	2.05	20	24	15.50	8.30
788 LL, TNL	1	5.861	3.11	2.822	0.450	20	15.875	12.125	6.6245

<b>Kwikset</b>									
<b>Combo Packs</b>									
690T Tylo Knob and Single Cylinder Deadbolt	1	11.3090	3.4230	2.7840	2.8000	6	8.7500	7.3120	11.9375
<b>Deadbolts</b>									
598 Single Cylinder Gate Latch	1	4.6730	3.9230	3.0720	2.2500	12	12.8750	12.5000	5.3125
599 Double Cylinder Gate Latch	1	4.6730	3.9230	3.0720	2.2500	12	12.8750	12.5000	5.3125
660 Single Cylinder	1	3.9480	3.4230	2.5720	0.5000	12	11.1250	11.0000	4.5625
665 Double Cylinder	1	3.9480	3.4230	2.5720	0.9000	12	11.1250	11.0000	4.5625
663 One-Sided	1	3.9480	3.4230	2.5720	0.5500	12	11.1250	11.0000	4.5625
667 One-Sided	1	3.9480	3.4230	2.5720	0.9000	12	11.1250	11.0000	4.5625
664 Retrofit Kit	1	3.9480	3.4230	2.5720	0.9000	12	11.1250	11.0000	4.5625
677 One-Sided	1	3.9480	3.4230	2.5720	0.2500	12	11.1250	11.0000	4.5625
<b>Handlesets</b>									
604 Single Cylinder	1	5.8000	3.9000	3.7000	2.25	12	15.20	12.5	7
605 Double Cylinder	1	5.8000	3.9000	3.7000	2.25	12	15.20	12.5	7
606 Dummy	1	5.8000	3.9000	3.7000	2.25	12	15.20	12.5	7
687 LIP	1	15.9380	7.1250	4.0000	3.6000	6	15.0000	12.1250	16.6255
689 LIP	1	15.9380	7.1250	4.0000	4.0000	6	15.0000	12.1250	16.6255
699 LIP	1	15.9380	7.1250	4.0000	3.6000	6	15.0000	12.1250	16.6255
<b>Knobs</b>									
200 Polo	1	8.1730	3.2980	2.7840	1.3000	30	17.1250	17.0000	8.8125
300 Polo	1	8.1730	3.2980	2.7840	1.3000	30	17.1250	17.0000	8.8125
400 Polo	1	8.1730	3.2980	2.7840	1.3000	30	17.1250	17.0000	8.8125
200 Tylo/Cove	1	7.3610	3.2980	2.7840	1.1500	30	17.1250	17.0000	8.1870
300 Tylo/Cove	1	7.3610	3.2980	2.7840	1.1500	30	17.1250	17.0000	8.1870
400 Tylo/Cove	1	7.3610	3.2980	2.7840	1.1500	30	17.1250	17.0000	8.1870
488 Dummy	1	3.2360	2.7980	3.0100	0.3500	20	14.8750	12.5000	3.9375
<b>Lever</b>									
200 Passage	1	6.7980	5.7660	2.9720	1.3500	20	23.6250	15.3750	7.4995
300 Privacy	1	6.7980	5.7660	2.9720	1.3500	20	23.6250	15.3750	7.4995
405 Keyed Lever	1	6.7980	5.7660	2.9720	1.5800	20	23.6250	15.3750	7.4995
488 Dummy	1	5.8610	3.1100	2.8220	0.4500	20	15.8750	12.1250	6.6245

<b>Miscellaneous</b>									
<b>Pocket Door Hardware</b>									
332 Passage	1	3.2	2.8	1.6	0.52	12	10.1	5.8	3.6
333 Privacy	1	3.1	2.8	1.6	0.42	12	10.2	6.1	3.7
334 Passage	1	4.3750	3.0000	2.0000	.65	12	12.5000	14.3750	2.2500
335 Privacy	1	4.3750	3.0000	2.0000	.8	12	12.5000	14.3750	2.2500

BOX PACK	Unit					Master Case			
	Quantity	Length (in.)	Width (in.)	Height (in.)	Weight (lbs.)	Quantity	Length (in.)	Width (in.)	Height (in.)
<b>Kwikset Multi-Family / Light Commercial</b>									
<b>Burbank, Carson, and Palmina</b>									
407	1	6.75	5.75	2.75	0.5	1	7.93	6.06	3.12
408	1	6.75	5.75	2.75	0.5	1	7.93	6.06	3.12
438	1	6.75	5.75	2.75	1.0	1	7.93	6.06	3.12
439	1	6.75	5.75	2.75	1.0	1	7.93	6.06	3.12
488	1	5.18	3.00	2.43	0.55	1	15.75	12.00	6.56
<b>Kingston</b>									
721KNL	1	6.75	5.75	2.75	1.5	1	7.93	6.06	3.12
733KNL	1	6.75	5.75	2.75	1.5	1	7.93	6.06	3.12
756KNL SMT	1	6.75	5.75	2.75	2.33	1	7.93	6.06	3.12
781KNL SMT	1	6.75	5.75	2.75	2.33	1	7.93	6.06	3.12
788 LVR	1	5.18	3.00	2.43	0.87	1	15.13	12.75	3.50
<b>SmartKey Padlock</b>									
50MM SmartKey Padlock Std. Shackle	6	2.56	1.46	4.65	1.10	6	5.39	4.80	5.04
50MM SmartKey Padlock Long Shackle	6	2.56	1.46	4.65	1.14	6	5.39	4.80	5.04





Customer Service Toll Free Line:  
 (800) 422-LOCK (800) 422-5625  
 FAX (866) 507-8369

email: [kworders@spectrumbands.com](mailto:kworders@spectrumbands.com)

Monday to Friday, 6:00 a.m. to 4:00 p.m. PST

Job Name: \_\_\_\_\_  
 Notes: \_\_\_\_\_

Delivery Address: \_\_\_\_\_

Phone: \_\_\_\_\_

Fax: \_\_\_\_\_

Contact: \_\_\_\_\_

Company Name: \_\_\_\_\_

Address: \_\_\_\_\_

Store Number: \_\_\_\_\_

Line No.	Function		Style		Handing	Rose		Finish		Door Thickness	OPTIONS				Quantity	Price	Extended Price
	Exterior	Interior	Exterior	Interior		Exterior	Interior	Exterior	Interior		Latch	Strike	Cylinder	Keying			
1																	
2																	
3																	
4																	
5																	
6																	
7																	
8																	
9																	
10																	
11																	
12																	
13																	
14																	
15																	
16																	
17																	
18																	
19																	
20																	

To order service parts, provide service part # and quantity.  
 How to order questions, refer back to page A:3 for General Information.

**Kwikset**

# OBSIDIAN

TOUCHSCREEN ELECTRONIC DEADBOLT



**16** User Codes

ANSI GRADE  
**2** **BHMA**  
CERTIFIED



## Features

- Sleek, modern design
- Capacitive touchscreen
- Keywayless
- Tamper resistant interior cover
- 9V battery backup power

## User Codes

- Up to 16 user access codes for family and guests
- Mastercode feature for improved user access code management

## Additional Features

- SecureScreen™ patented security feature helps to ensure that user codes cannot be identified by examining fingerprints on screen

# Kwikset

# OBSIDIAN

TOUCHSCREEN ELECTRONIC DEADBOLT

## Specifications

<b>Function</b>	Single Cylinder Deadbolt
<b>Door Prep</b>	1 1/2" and 2 1/8" diameter face hole and 1" diameter latch hole
<b>Backset</b>	Adjustable 2 3/8" or 2 3/4"
<b>Door Thickness</b>	1 3/8" - 2"
<b>Faceplates</b>	1" x 2 1/4" round corner standard
<b>Strikes</b>	Round corner
<b>Latch</b>	Round corner adjustable 2 3/8" x 2 3/4"
<b>Bolt</b>	1" throw, steel deadbolt
<b>Door Handing</b>	Reversible
<b>Batteries</b>	6V (4 x AA alkaline batteries required)

## Dimensions

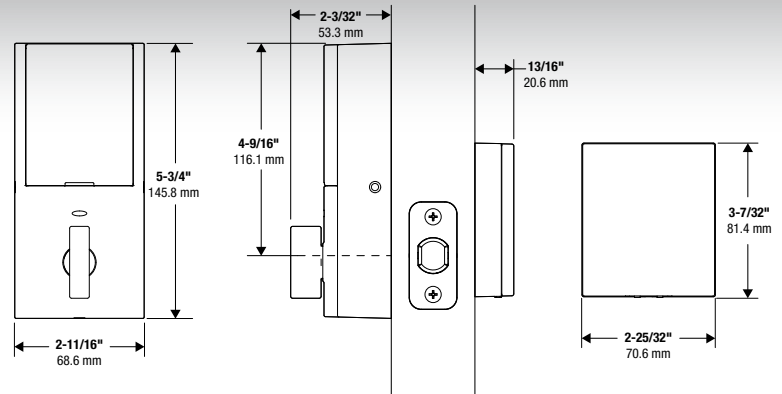

## Easy Installation

- Installs in minutes with only a screwdriver
- Fits all standard doors
- No new screw holes required
- No hard wiring needed

## Innovation Security

- BHMA Grade 2 Certified
- 128-bit Advanced Encryption Standard (AES) communication
- SecureScreen™ - patented security feature
- Mastercode feature
- 16 user access code capacity

## Finishes



Satin Nickel 15



Venetian Bronze 11P

FINISH AND  
**LIFETIME  
WARRANTY**  
MECHANICAL  
ONE YEAR  
ELECTRONIC WARRANTY

19701 DaVinci, Lake Forest, CA 92610 • Kwikset.com • 1-800-327-LOCK

© 2017 Spectrum Brands, Inc. Kwikset is a trademark of Spectrum Brands, Inc. • 103195-KW

# Kwikset

# kēvo™

Touch-to-Open® Smart Lock

## 2nd Generation

### Overview

- 2nd Generation smart lock
- Touch-to-Open™ convenience
- Smaller and sleeker metal interior
- Improved install experience

### Security

- Military grade PKI encryption
- Inside/Outside Positioning Technology
- New Advanced SmartKey Security™

### Kevo App

- Share and manage eKey access via smartphone
- Receive notifications
- Monitor lock history
- Download from



Open your world with the latest Touch-to-Open™ Kevo smart lock powered by your smartphone and Bluetooth.



Kevo is compatible with:



Nest® Learning Thermostat



Apple® Watch



Honeywell® Thermostats™ (select models)



Ring™ Video Doorbell



Skybell® WiFi Doorbell



Android Wear

For a complete compatibility list: [www.kwikset.com/kevo/compatibility](http://www.kwikset.com/kevo/compatibility)

# kēvo™

## Touch-to-Open® Smart Lock

### Dimensions

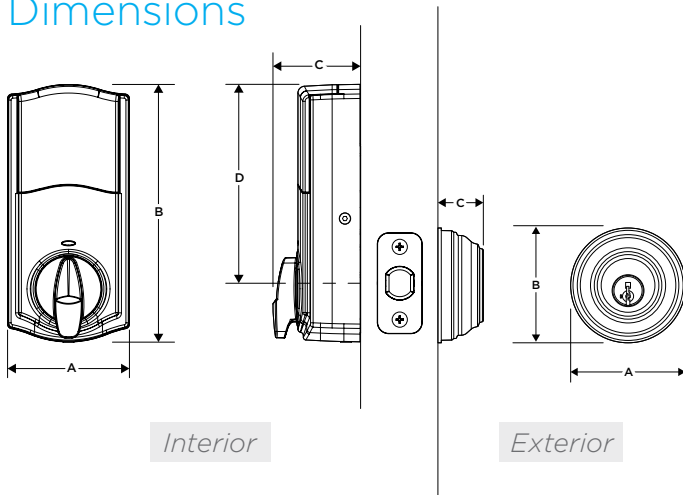

Design	A	B	C	D
Kevo™ Interior	2 3/4" (50.8 mm)	5 3/4" (146.05 mm)	2" (44.45 mm)	1 3/16" (30.16 mm)
Kevo™ Exterior	2 3/4" (69.85 mm)	2 3/4" (69.85 mm)	1 5/32" (29.37 mm)	---

### Finishes



Polished Brass LOS

Satin Nickel 15

Venetian Bronze 11P

### System Requirements

- Bluetooth Smart ready with a Bluetooth 4.0 enabled device
- Data connection required to download Kevo mobile app
- Smartphone compatibility: Apple iPhone 4S or higher and Android 5.0 (Lollipop) or higher. Check here for an updated compatibility list: [www.kwikset.com/Kevo](http://www.kwikset.com/Kevo)

### Specifications

<b>Function</b>	Single Cylinder Deadbolt
<b>Door Prep</b>	2 1/8" diameter face hole & 1" diameter latch hole
<b>Backset</b>	Adjustable 2 3/8" or 2 3/4"
<b>Door Thickness</b>	1 3/4" automatic adjustment
<b>Cylinder</b>	SmartKey Security™
<b>Faceplates</b>	1" x 2 1/4" round corner standard
<b>Strikes</b>	Round corner strike 2 3/4" x 1 1/8"
<b>Latch</b>	Round corner adjustable 2 3/8" x 2 3/4"
<b>Bolt</b>	1" throw, steel deadbolt
<b>Door Handing</b>	Reversible
<b>Batteries</b>	4AA Required

### What's In The Box

- Kevo deadbolt
- 4 AA batteries
- 2 eKeys
- 2 standard keys

### Accessories (sold separately)

- Works with Fob if you don't have a smartphone
- Kevo Plus for remote access



# Kwikset

# kēvo™

## CONVERT

Smart Lock Conversion Kit



Transform your existing deadbolt into a smart lock.

Kevo Convert replaces the interior part of your current door lock for smarter access to your home using your smartphone. The exterior of your door remains unchanged and traditional keys will still work as a backup.

### Simple to Use

Intuitive Kevo app includes all the convenient features you need right at your fingertips.

- **InHome Locking/Unlocking**  
Upstairs when guests arrive? No problem. You can unlock the door within Bluetooth® range of the lock.
- **Easy eKey Management**  
Send an electronic key (eKey) to family, friends, or visitors. Add, delete or disable eKeys instantly. Select between anytime, 24-hour or scheduled access.
- **Convenient Monitoring**  
View history of lock activity and receive notifications when guests arrive.
- **Smart Home Compatible**  
Link Kevo Convert to other smart products you already have such as Nest® Thermostat, Android Wear, and Ring™ Video Doorbell.

For a complete compatibility list:  
[www.kwikset.com/kevo/compatibility](http://www.kwikset.com/kevo/compatibility)

Interior Shown



Kevo Convert works with standard cylinder deadbolts including: Kwikset®, Weiser®, Baldwin® and Schlage®.



# kēvo™

## CONVERT

### Dimensions

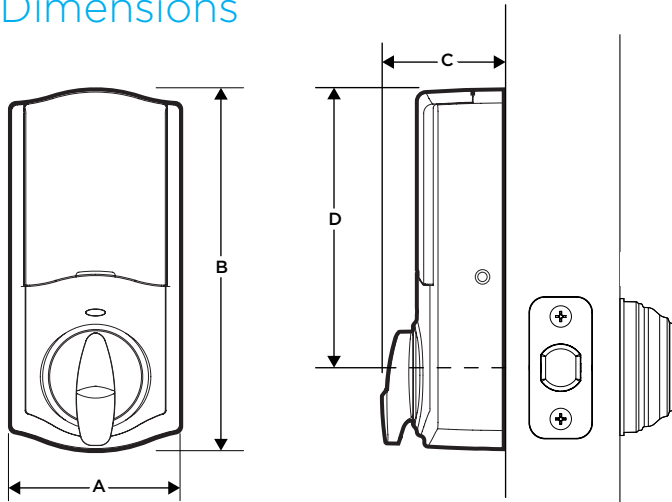

Design	A	B	C	D
Kevo™ Convert	2 3/4" (69.85 mm)	5 3/4" (146.05 mm)	2" (50.8 mm)	4 9/16" (115.88 mm)

### Compatible

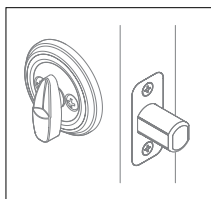

Standard

### Not Compatible

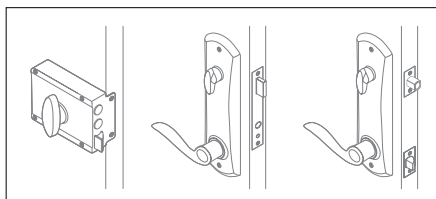

Rim Cylinder

Mortise

Integrated

Visit [Kwikset.com/Kevo](http://Kwikset.com/Kevo) for details

### Finishes



Venetian  
Bronze 11P



Satin  
Nickel 15

### System Requirements

- Smartphone compatibility: Apple iPhone 4S or higher and select Android 5.0 (Lollipop) or higher. Requires iOS 8 or higher and Android 5.0 or higher.
- Data connection required to download Kevo mobile app
- Visit [kevosmart.com](http://kevosmart.com) for details
- Download App from



### Specifications

<b>Function</b>	Smart Lock Conversion kit
<b>Backset</b>	Adjustable 2 3/8" or 2 3/4"
<b>Door Thickness</b>	1 3/8" - 1 3/4" automatic adjustment
<b>Door Handing</b>	Reversible
<b>Batteries</b>	4AA Required

### What's In The Box

- Kevo Convert Unit
- Lock Adapters
- Mounting Hardware
- 4 AA Batteries

### Accessories (sold separately)

- Add Kevo Plus gateway for remote WiFi access from anywhere

# Kwikset



## Smarter Living

Premis™ Smart Lock features Apple HomeKit™ technology for smarter home management.



# Premis™

## TOUCHSCREEN SMART LOCK



### Siri® Voice Control

Lock and unlock your door using Siri voice commands

### Lock Monitoring\*

View lock activity, history and status notifications when lock is used.

### Remote Access\*

Control and monitor lock status from anywhere using the Kwikset Premis iOS app and Apple TV®

### User Code Management

Easily send, add, and delete or disable user codes. Schedule access for certain times/days.



# Premis™

## TOUCHSCREEN SMART LOCK

### Dimensions

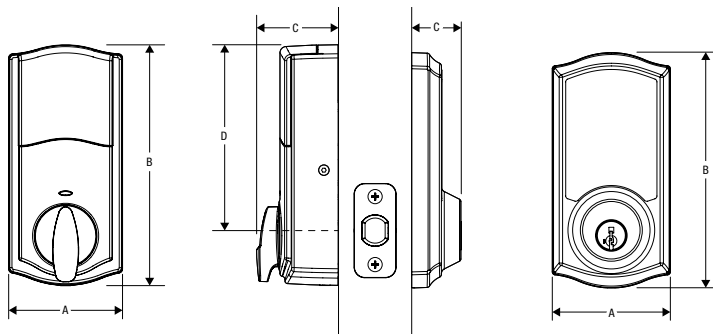

Design	A	B	C	D
Interior	2 3/4" (70 mm)	5 3/4" (146 mm)	1 15/16" (49 mm)	4 9/16" (116 mm)
Exterior	2 13/16" (72 mm)	5 5/8" (143 mm)	1 3/16" (30 mm)	---

### Specifications

<b>Function</b>	Single cylinder deadbolt
<b>Door Prep</b>	2 1/8" diameter bore hole & 1" diameter latch hole
<b>Backset</b>	Adjustable 2 3/8" or 2 3/4"
<b>Door Thickness</b>	1 3/8" - 2" automatic adjustment
<b>Faceplates</b>	1" x 2 1/4" round corner standard
<b>Strikes</b>	Round corner, 4 hole strike, 2 3/4" x 1 1/8"
<b>Latch</b>	Round corner adjustable 2 3/8" x 2 3/4"
<b>Bolt</b>	1" throw, steel deadbolt
<b>Door Handing</b>	Reversible
<b>Cylinder</b>	SmartKey Security™



Interior

Exterior

### Innovative Security

- BHMA grade 2 certified
- 20 Minute fire rating - UL certified
- Full 128-bit encryption security
- Featuring SmartKey Security™ - providing superior security against advanced break-in techniques.
- Revolutionary tapered deadbolt design—enables misaligned doors to lock without pulling and pushing your door shut

### Easy Integration

- Replaces existing door hardware with just a screwdriver
- No hard wiring needed
- Operates on 4 AA batteries that will last for approximately 1 year

### Warranty

- Lifetime mechanical and finish warranty
- 1 year electronic warranty

**Kwikset**

Introducing  
**SAN CLEMENTE**

Featuring  **SMARTKEY  
SECURITY.**



**The San Clemente handleset has a sleek, modern look.** With clean lines and a variety of finishes, you can easily upgrade the entry to your home.

- Features New Advanced SmartKey Security™
- Low Profile Contemporary Design
- Handleset Deadbolt has ANSI/BHMA Grade 1 Certified Security
- Lifetime Mechanical and Finish Warranty

**#1 SELLING U.S. LOCK BRAND\***

\*Source: TraQline US quarterly brand unit share report, Q4 2006 through Q1 2017

## Specifications

<b>Door Prep</b>	Cross Bore 2 1/8". Edge Bore 1" Latch Face 1" x 2 1/4"
<b>Backset</b>	Adjustable 2 3/8" or 2 3/4"
<b>Door Thickness</b>	1 3/4" Standard. Thick door service part available for up to 2 1/4"
<b>Faceplates</b>	1" x 2 1/4". Specify square, round, or drive in
<b>Strikes</b>	<ul style="list-style-type: none"> <li>• <b>Deadbolt:</b> 1 1/4" x 3 5/8". Specify square, round, or drive in</li> <li>• <b>Handle:</b> 2 1/4" full lip. Specify square, round, or drive in (Other options available)</li> </ul>
<b>Bolt</b>	<ul style="list-style-type: none"> <li>• <b>Deadbolt:</b> 1" throw</li> <li>• <b>Handle:</b> 1/2" throw</li> </ul>
<b>Cylinder</b>	SmartKey Security™
<b>Door Handing</b>	Reversible for right or left-hand doors
<b>ANSI/BHMA</b>	Deadbolt is Grade 1 Certified
<b>UL</b>	Optional 20 minute UL fire rating available except for 819 function
<b>ADA</b>	N/A
<b>Warranty</b>	Lifetime mechanical and lifetime finish

## Dimensions

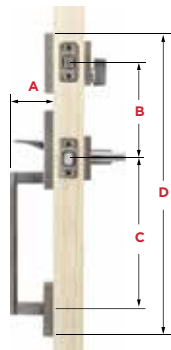

Dimensions	A	B	C	D
San Clemente	2 5/8"	5 1/2"	8 13/32" through 9 11/16"	17 29/32"

## Finishes



**11P**  
Venetian  
Bronze

**15**  
Satin  
Nickel

**26**  
Polished  
Chrome

**26D**  
Satin  
Chrome

**514**  
Iron  
Black

## NEW Adjustable Throughbolt

Vertical and horizontal slide designed for a guaranteed fit

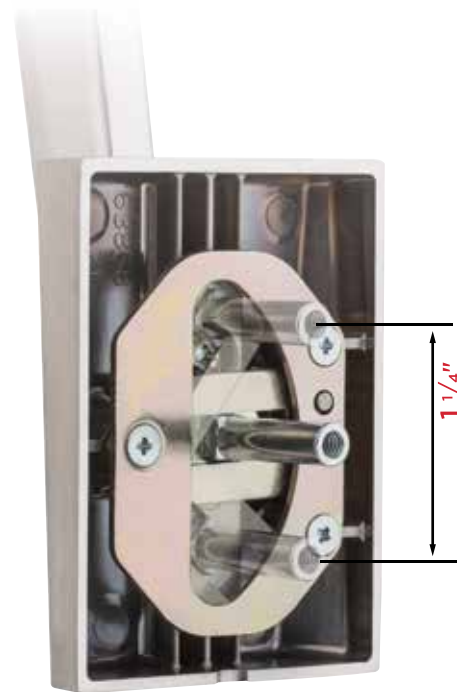

## Functions

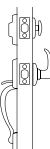
- NEW**  **Handleset (Single-Cylinder):** Exterior only, Latch bolt operated by thumb piece outside. Deadbolt operated by key outside.  
- **818 SCE SMT**

---

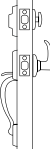
- NEW**  **Handleset (Dummy):** Exterior only, Handle acts as pull only. For inactive leaf or double doors. No Operation.  
- **819 SCE**

---

-  **Handle with Lever:** Latch bolt operated by thumb piece outside and lever inside. No Deadbolt.  
- **815 SCE x HFL**  
[Available with Halifax (HFL) lever]

---

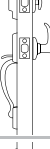
- NEW**  **Interior Pack (Single-Cylinder):** Interior only, Latch bolt operated by lever inside. Deadbolt operated by thumb turn inside.  
- **971\_\_SMT**  
(Indicate interior lever style)

---

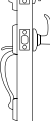
- NEW**  **Interior Pack (Dummy):** Interior only, Lever acts as a pull only. For inactive leaf or double doors. No operation.  
- **973\_\_**  
(Indicate interior lever style)

No Double-Cylinder Function Available

**Kwikset**



Introducing

# CAMINO

Featuring  **SMARTKEY  
SECURITY.**



**The Camino handleset makes a bold statement with its faceted, geometric shape.** With this refined style, you can elevate the look of your front door.

- Features New Advance SmartKey Security™
- Low Profile Contemporary Design
- Handleset Deadbolt has ANSI/BHMA Grade 1 Certified Security
- Lifetime Mechanical and Finish Warranty

**#1 SELLING U.S. LOCK BRAND\***

\*Source: TraQline US quarterly brand unit share report, Q4 2006 through Q1 2017

121123 3/17

## Specifications

<b>Door Prep</b>	Cross Bore 2 1/8". Edge Bore 1" Latch Face 1" x 2 1/4"
<b>Backset</b>	Adjustable 2 3/8" or 2 3/4"
<b>Door Thickness</b>	1 3/4" Standard. Thick door service part available for up to 2 1/4"
<b>Faceplates</b>	1" x 2 1/4". Specify square, round, or drive in
<b>Strikes</b>	<ul style="list-style-type: none"> <li>▪ <b>Deadbolt:</b> 1 1/4" x 3 5/8". Specify square, round, or drive in</li> <li>▪ <b>Handle:</b> 2 1/4" full lip. Specify square, round, or drive in (Other options available)</li> </ul>
<b>Bolt</b>	<ul style="list-style-type: none"> <li>▪ <b>Deadbolt:</b> 1" throw</li> <li>▪ <b>Handle:</b> 1/2" throw</li> </ul>
<b>Cylinder</b>	SmartKey Security™
<b>Door Handing</b>	Reversible for right or left-hand doors
<b>ANSI/BHMA</b>	Deadbolt is Grade 1 Certified
<b>UL</b>	Optional 20 minute UL fire rating available except for 819 function
<b>ADA</b>	N/A
<b>Warranty</b>	Lifetime mechanical and lifetime finish

## Dimensions

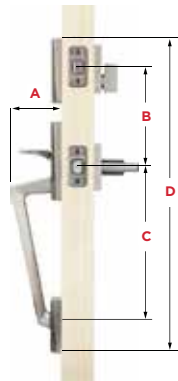

Dimensions	A	B	C	D
San Clemente	2 15/16"	5 1/2"	8 13/32" through 9 11/16"	17 5/8"

## Finishes



**11P**  
Venetian  
Bronze

**15**  
Satin  
Nickel

**26**  
Polished  
Chrome

**26D**  
Satin  
Chrome

**514**  
Iron  
Black

## NEW Adjustable Throughbolt

Vertical and horizontal slide designed for a guaranteed fit

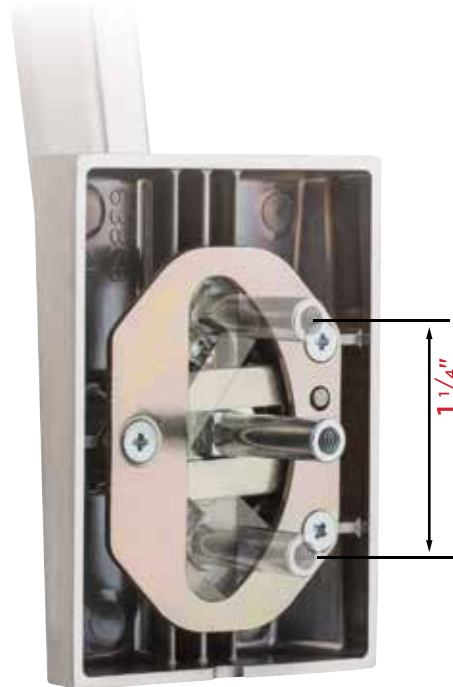

## Functions

**NEW**

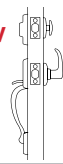

**Handleset (Single-Cylinder):** Exterior only, Latch bolt operated by thumb piece outside. Deadbolt operated by key outside.  
- **818 CMH SMT**

**NEW**

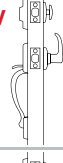

**Handleset (Dummy):** Exterior only, Handle acts as pull only. For inactive leaf or double doors. No Operation.  
- **819 CMH**

**NEW**

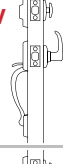

**Interior Pack (Single-Cylinder):** Interior only, Latch bolt operated by lever inside. Deadbolt operated by thumb turn inside.  
- **971\_\_\_SMT**  
(Indicate interior lever style)

**NEW**

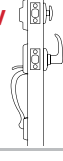

**Interior Pack (Dummy):** Interior only, Lever acts as a pull only. For inactive leaf or double doors. No operation.  
- **973\_\_\_**  
(Indicate interior lever style)

No Double-Cylinder Function Available



**Kwikset**



## **NEW CONTEMPORARY INTERCONNECT TRIM**

The perfect solution for multi-family housing, Interconnect provides quality, security and style while meeting ADA requirements and fire code ratings.

- Features SmartKey Security™
- Lifetime mechanical and finish warranty
- Lever options are in compliance with the American National Standards Institute (ANSI A117.1) and the Americans with Disabilities Act (ADA)
- Meets fire code rating for emergency panic exit

**THE #1 SELLING U.S. LOCK BRAND\***

\*Source: TraQline US quarterly brand unit share report, Q4 2006 through Q3 2013

97499-KW

## Interconnect Specifications

<b>Door Prep</b>	2 1/8" diameter face hole & 1" diameter latch hole
<b>Backset</b>	Adjustable 2 3/8" or 2 3/4"
<b>Door Thickness</b>	1 3/8" - 1 3/4" automatic adjustment
<b>Cylinder</b>	<ul style="list-style-type: none"> <li>• 506 and 508 utilize 6-pin or SmartKey Security™ on 780 deadbolt</li> <li>• 505 utilize 5-pin on 660 deadbolt</li> <li>• 502 - determined by handleset ordered</li> </ul>
<b>Faceplates</b>	1" x 2 1/4" round corner standard

<b>Strikes</b>	Deadbolt Strike: UL 5278, 3223 (WFL 4632 opt.).
<b>Door Handling</b>	506, 508, 505, 507 - reversible 502 - specify handing.
<b>ANSI/BHMA</b>	<ul style="list-style-type: none"> <li>• 506, 508, 505 - Grade 3 Certified</li> <li>• 502 - Determined by handleset ordered.</li> </ul>
<b>ADA</b>	Lever options are in compliance with the American National Standards Institute (ANSI A117.1) and the Americans with Disabilities Act (ADA)
<b>UL</b>	Meets 3 hour fire rating.

## Interconnect Dimensions

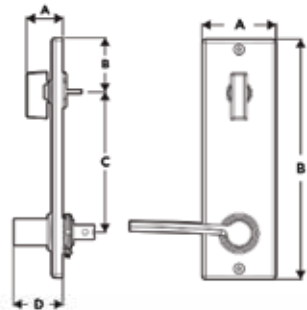

Dimensions	A	B	C	D
Interior	1 13/32"	2 1/16"	5 3/8"	1 29/32"
Exterior	2 27/32"	9 3/16"		

## Finishes



11P Venetian Bronze



15 Satin Nickel



26 Polished Chrome



26D Satin Chrome



Make sure you have your current key and SmartKey tool



Current Key



SmartKey Tool



New Key



**1** Insert current key and rotate it 90° clockwise.



**2**

**A** Fully insert the SmartKey tool.

**B** Remove tool and remove current key.

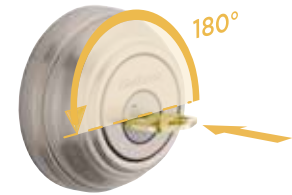

**3**

**A** Fully insert new key and rotate it 180°.

**B** Rotate back to the starting position, and remove key. **Your lock is now re-keyed!**



**Kwikset**

# Introducing **AMADOR**

Featuring  **SMARTKEY  
SECURITY.**



**Amador has a refined, structural look with its simplistic modern design.** Priced affordably, this handleset offers achievable style while maintaining superior security.

- Features SmartKey Security™
- ANSI/BHMA Grade 3 Certified Security & Quality
- Lifetime Mechanical Warranty

**THE #1 SELLING U.S. LOCK BRAND\***

\*Source: TraQline US quarterly brand unit share report, Q4 2006 through Q3 2013

114690-KW



## Amador Specifications

<b>Door Prep</b>	<ul style="list-style-type: none"> <li>▪ <b>Deadbolt:</b> 2-1/8" or 1-1/2" Edge Bore 1". Latch Face 1" x 2-1/4".</li> <li>▪ <b>Handle:</b> Cross Bore 2-1/8". Edge Bore 1".</li> </ul>
<b>Backset</b>	<ul style="list-style-type: none"> <li>▪ <b>Deadbolt:</b> Adjustable to 2-3/8" or 2-3/4".</li> <li>▪ <b>Handle:</b> Adjustable to 2-3/8" or 2-3/4".</li> </ul>
<b>Door Thickness</b>	<ul style="list-style-type: none"> <li>▪ 1-3/4" doors standard.</li> <li>▪ 2-1/4" doors optional.</li> <li>▪ Not designed for use on 1-3/8" doors.</li> </ul>
<b>Cylinder</b>	SmartKeySecurity™
<b>Faceplates</b>	1" x 2-1/4". Specify round corner, square corner or drive-in.
<b>Strikes</b>	<ul style="list-style-type: none"> <li>▪ <b>Deadbolt:</b> 1" x 2-1/4". Specify round corner or square corner. Other options available.</li> <li>▪ <b>Handle:</b> 2-1/4" full lip. Specify round corner or square corner. Other options available.</li> </ul>

<b>Bolt</b>	<ul style="list-style-type: none"> <li>▪ <b>Deadbolt:</b> 1" throw.</li> <li>▪ <b>Handle:</b> 1/2" throw.</li> </ul>
<b>Door Handing</b>	Reversible for right or left-hand doors.
<b>ANSI/BHMA</b>	Deadbolt is Grade 3 Certified.
<b>ADA</b>	N/A
<b>UL</b>	Optional UL 1/3 hour fire rating for all functions except 699 & 502.

## Amador Dimensions

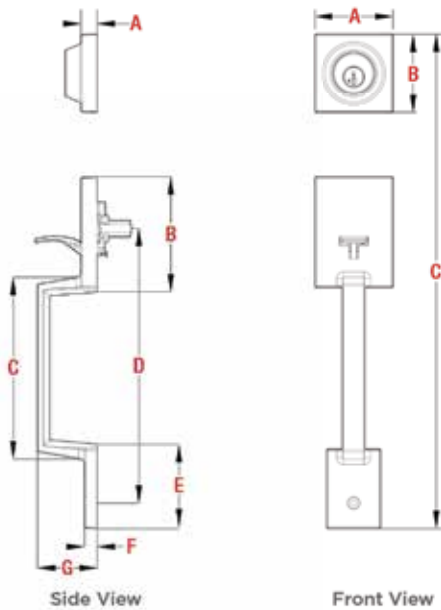

Dimensions	A	B	C	D	E	F	G
Side View	9/16"	4 1/16"	6 13/32"	9 11/16"	2 31/32"	7/16"	2 3/32"
Front View	2 25/32"	2 25/32"	17 15/32"				

## Finishes



**Kwikset's SmartKey™ Security** provides homeowners with the superior security that is resistant to a variety of common break-in methods.

This technology also allows homeowners to re-key their locks themselves in seconds, rendering lost or un-returned keys useless.

# Kwikset

## Introducing CONTEMPORARY DEADBOLT



**Kwikset's Contemporary Deadbolt has a sleek and simple design.**

Priced affordably, this deadbolt offers achievable style while maintaining superior security.

- Features SmartKey Security™
- ANSI/BHMA Grade 3 Certified Security & Quality
- Lifetime Mechanical Warranty

**THE #1 SELLING U.S. LOCK BRAND\***

\*Source: TraQline US quarterly brand unit share report, Q4 2006 through Q1 2017

120556-KW

## Specifications

<b>Door Prep</b>	<ul style="list-style-type: none"> <li>• <b>660, 665:</b> Cross Bore 2 1/8", Edge Bore 1". Latch face 1" x 2 1/4".</li> <li>• <b>663:</b> Crossbore 1-5/8", Edge Bore 1". Latch Face 1" x 2-1/4".</li> </ul>
<b>Backset</b>	<ul style="list-style-type: none"> <li>• <b>660, 665:</b> Adjustable latch standard.</li> <li>• <b>663:</b> Adjustable to 2 3/8" or 2 3/4" standard.</li> </ul>
<b>Door Thickness</b>	<b>660, 663, 665:</b> 1-3/8" - 1 -1/4" doors standard.
<b>Cylinder</b>	<b>660, 665:</b> SmartKey Security™
<b>Faceplates</b>	1" x 2-1/4". Specify round corner, square corner or drive-in.
<b>Strikes</b>	1" x 2-1/4". Specify round corner or square corner. Other options available.

<b>Bolt</b>	1" throw.
<b>Door Handling</b>	Reversible for right or left-hand doors.
<b>ANSI/BHMA</b>	Grade 3 Certified
<b>ADA</b>	Interior turn piece is in compliance with the American National Standards Institute (ANSI A117.1) and the Americans with Disabilities Act (ADA).
<b>UL</b>	N/A

## Dimensions

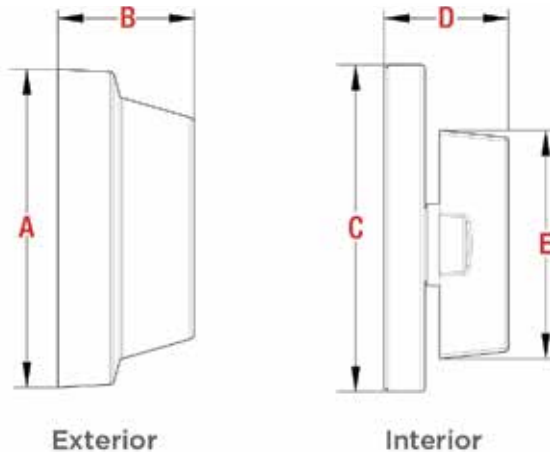

Dimensions	A	B	C	D	E
Exterior	2 7/16"	1 1/16"			
Interior			2 1/2"	3 1/32"	1 3/4"



Kwikset's SmartKey Security™ provides homeowners with the superior security that is resistant to a variety of common break-in methods.

This technology also allows homeowners to re-key their locks themselves in seconds, rendering lost or un-returned keys useless.

## Finishes



**11P**  
Venetian  
Bronze



**15**  
Satin  
Nickel



**26**  
Polished  
Chrome



**26D**  
Satin  
Chrome

**Kwikset**



## UPTOWN™ & DOWNTOWN™

The latest in contemporary design, these deadbolts are the first of their kind, featuring a half-inch projection off the door and the latest version of Kwikset patented SmartKey Security.™

- 50% Less Protrusion than Standard Deadbolts
- Highest Residential Security Rating: Grade 1
- New Advanced SmartKey Security™
- Perfectly match Kwikset's contemporary product portfolio



Uptown™ in Venetian Bronze



Downtown™ in Venetian Bronze

## Specifications:

<b>Door Prep</b>	Cross Bore 2-1/8". Edge Bore 1".
<b>Backset</b>	Adjustable to 2-3/8" or 2-3/4" standard.
<b>Door Thickness</b>	1-3/8" - 1-3/4" doors standard. Thick door service part available for up to 2 1/4".
<b>Cylinder</b>	SmartKey Security™
<b>Faceplates</b>	1" x 2 1/4". Specify round corner, square corner or drive-in.

<b>Strikes</b>	1" x 2 1/4" square or round corner.
<b>Bolt</b>	1" throw.
<b>Door Handling</b>	Reversible for right or left-hand doors.
<b>ANSI/BHMA</b>	Grade 1
<b>UL</b>	20 Minute Fire Rating available upon request.
<b>Warranty</b>	Lifetime Mechanical and Lifetime Finish

## Functions:



### 258 Single Cylinder:

Deadbolt operated by key outside and thumb turn inside.

## Dimensions:

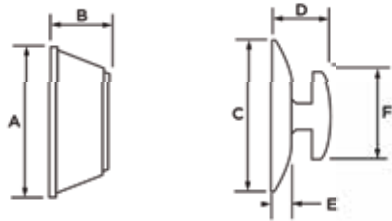

Design	A	B	C	D	E	F
258 SQT	2-5/8"	1/2"	2-5/8"	1-3/8"	7/16"	1-8/13"
258 RDT	2-5/8"	1/2"	2-5/8"	1-7/16"	7/16"	1-11/17"



Uptown™ in Satin Nickel



Downtown™ in Satin Nickel

## Finish Availability:



514  
Iron  
Black



11P  
Venetian  
Bronze



15  
Satin  
Nickel



26  
Polished  
Chrome



26D  
Satin  
Chrome



**Kwikset**



## Slow the Growth of Bacteria

Kwikset® and Microban®, the global leader in built-in antimicrobial protection, have teamed up to improve the standard for door hardware. Kwikset® will now offer antimicrobial protection on select products, inhibiting the growth of bacteria on frequently touched door hardware in the home.

THE #1 SELLING U.S. LOCK BRAND\*

\*Source: TraQline US quarterly brand unit share report, Q4 2006 through Q3 2017

96417-KW

## Benefits of Kwikset® Door Hardware with Microban® Technology

Bacteria can double every 20 minutes on unprotected surfaces, but Kwikset Door Hardware with Microban protection works to continuously fight off microbes.

- Door hardware is 99.9% cleaner than knobs without Microban
- The antimicrobial coating last for the lifetime of the hardware finish, so you can worry less and feel more secure in your home.
- No need to clean door hardware - 24/7 Antimicrobial protection
- Kwikset with Microban protection is effective against a broad spectrum of bacteria

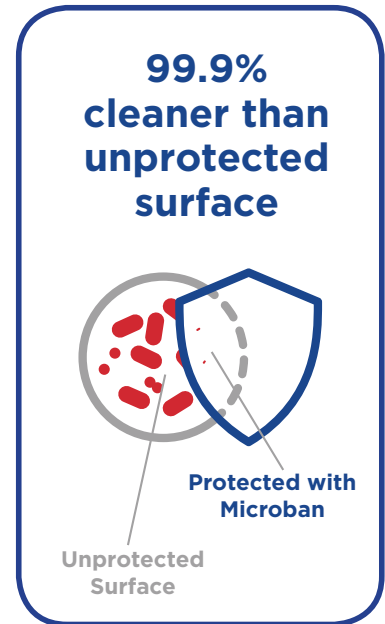

## Microban finish is available on select Kwikset® products.

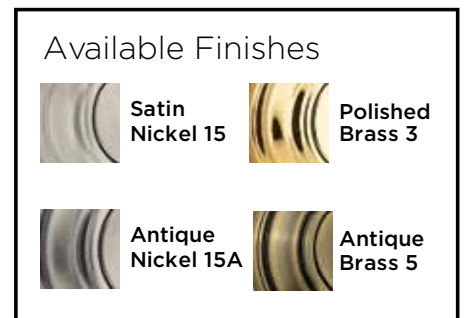

Look for the Microban sticker:



Additional Styles Coming Soon

# Kwikset



## SMARTCODE 913

TOUCHPAD ELECTRONIC DEADBOLT

The SmartCode 913 is a keypad electronic deadbolt with a metal housing that delivers quality that can be felt for added security and durability. Its contemporary design complements homes with a modern décor.

### New Features

- New contemporary design
- Sleek metal design for enhanced quality
- Dramatically reduced interior size
- Tamper resistant interior cover

### User Codes

- Up to 16 user access codes for family & guests
- Mastercode feature for improved user access code management



**#1 SELLING U.S. LOCK BRAND\***

\*Source: TraQline US quarterly brand unit share report, Q4 2006 through Q3 2017



## Specifications

<b>Function</b>	Single cylinder deadbolt
<b>Door Prep</b>	2 1/8" diameter face hole & 1" diameter latch hole
<b>Backset</b>	Adjustable 2 3/8" or 2 3/4"
<b>Door Thickness</b>	1 3/8" - 2" automatic adjustment
<b>Faceplates</b>	1" x 2 1/4" round corner standard
<b>Strikes</b>	Round corner strike 2 3/4" x 1 1/8"
<b>Latch</b>	Round corner adjustable 2 3/8" x 2 3/4"
<b>Bolt</b>	1" throw, steel deadbolt
<b>Door Handing</b>	Reversible
<b>Cylinder</b>	SmartKey Security™

## Dimensions

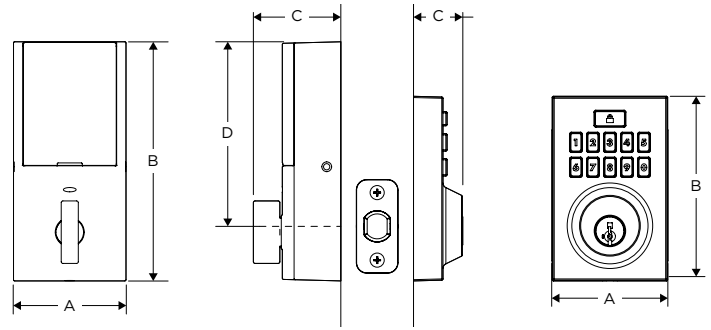

Design	A	B	C	D
Interior	2 11/16" (68.6 mm)	5 3/4" (145.8 mm)	2 3/32" (53.3 mm)	4 9/16" (116.1 mm)
Exterior	2 25/32" (70.7 mm)	4 7/16" (113 mm)	1 3/16" (29.8 mm)	---

## Easy Intergration

- Replaces existing door hardware with just a screwdriver
- No hard wiring needed
- Operates on 4 AA batteries that will last for approximately 1 year

## Innovative Security

- BHMA Grade 2 certified
- 20 Minute fire rating - UL certified
- Featuring SmartKey Security™ - providing superior security against advanced break-in techniques.
- Revolutionary tapered deadbolt design - enables misaligned doors to lock without pulling and pushing your door shut

## Finishes



**99130-008**  
Satin Nickel <sup>15</sup>  
913CNT 15



**99130-009**  
Venetian Bronze <sup>11P</sup>  
913CNT 11P



**99130-010**  
Polished Chrome <sup>26</sup>  
913CNT 26

FINISH AND  
**LIFETIME WARRANTY**  
MECHANICAL  
ONE YEAR  
ELECTRONIC WARRANTY





## Superior Security Features

- ANSI/BHMA Grade 1 Certified 980/985 Deadbolt
- SmartKey Security - providing superior security against advanced break-in techniques.

## Elegant Styles And Finishes

- Traditional to Contemporary Styles

## Warranty

- Lifetime Mechanical
- Lifetime Finish

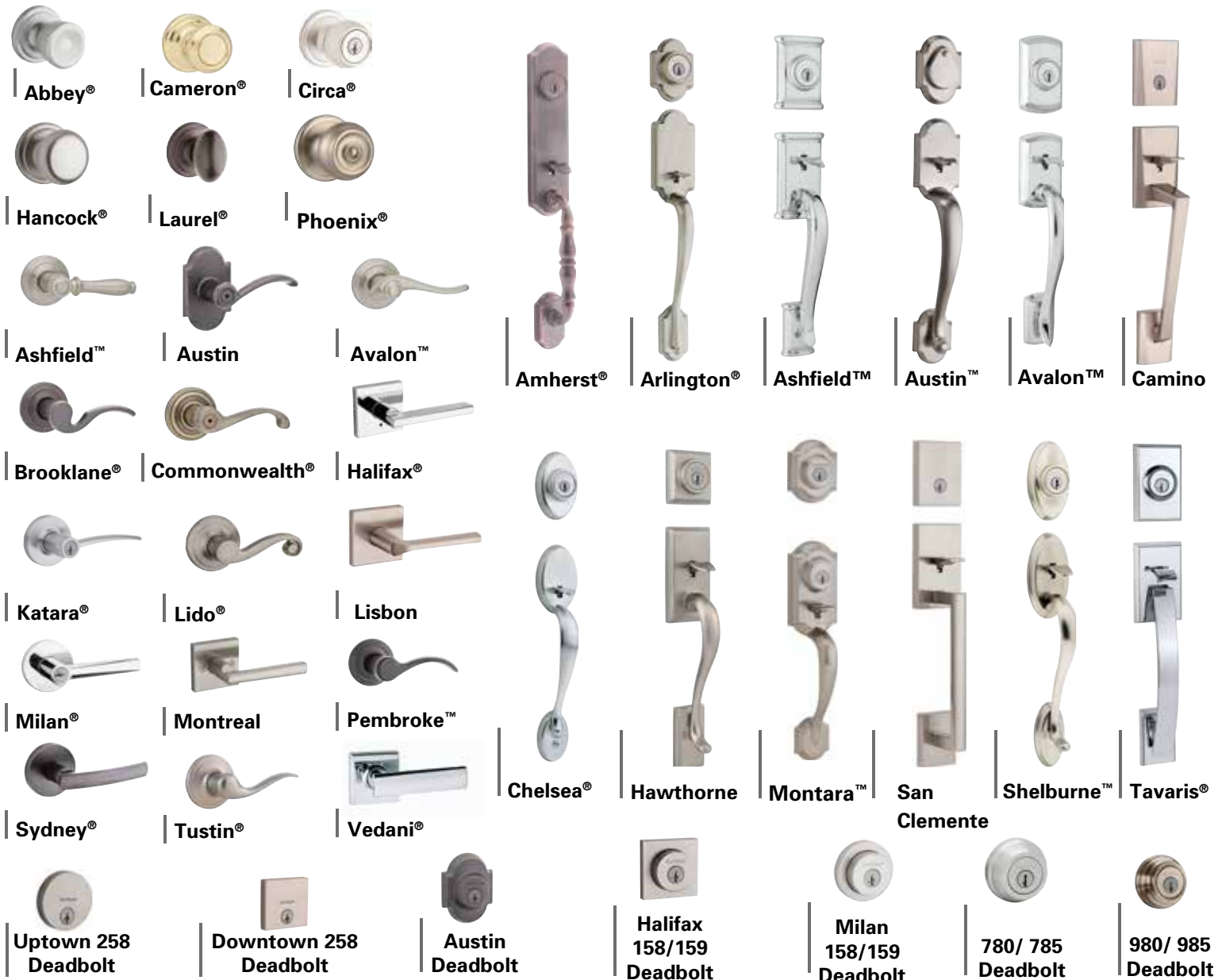



Amherst®	Model	Function	Finish								Case		
			3	L03	5	11P	15	15A	26	26D	514	Qty	
800AT	Single Cylinder					\$284.00	\$284.00						4
800AT SMT	Single Cylinder					\$284.00	\$284.00						4
801AT	Double Cylinder					\$289.00	\$289.00						4
801AT SMT	Double Cylinder					\$289.00	\$289.00						4
802AT	Dummy					\$257.00	\$257.00						4

Camino	Model	Function	Finish								Case		
			3	L03	5	11P	15	15A	26	26D	514	Qty	
818CMH SMT	Single Cylinder					\$264.00	\$264.00		\$264.00	\$264.00	\$274.00		4
819CMH	Dummy					\$237.00	\$237.00		\$237.00	\$237.00	\$247.00		4
814CMH	Handle Only†					\$199.00	\$199.00		\$199.00	\$199.00	\$209.00		4

San Clemente	Model	Function	Finish								Case		
			3	L03	5	11P	15	15A	26	26D	514	Qty	
818SCE SMT	Single Cylinder					\$264.00	\$264.00		\$264.00	\$264.00	\$274.00		4
819SCE	Dummy					\$237.00	\$237.00		\$237.00	\$237.00	\$247.00		4
814SCE	Handle Only†					\$199.00	\$199.00		\$199.00	\$199.00	\$209.00		4
815SCE	Handle with Halifax Lever†					\$264.00	\$264.00		\$264.00	\$264.00	\$274.00		6

**NOTE:** Handlesets ordered LIP only  
 †Denotes handleset without deadbolt



Ashfield®	Model	Function	Finish								Case Qty
			3	L03	5	11P	15	15A	26	26D	
800ADH	Single Cylinder		\$254.00	\$254.00	\$254.00	\$254.00		\$254.00		\$264.00	4
800ADH SMT	Single Cylinder		\$254.00	\$254.00	\$254.00	\$254.00		\$254.00		\$264.00	4
801ADH	Double Cylinder		\$259.00	\$259.00	\$259.00	\$259.00		\$259.00		\$269.00	4
801ADH SMT	Double Cylinder		\$259.00	\$259.00	\$259.00	\$259.00		\$259.00		\$269.00	4
802ADH	Dummy		\$227.00	\$227.00	\$227.00	\$227.00		\$227.00		\$237.00	6
814ADH	Handle Only <sup>†</sup>		\$189.00	\$189.00	\$189.00	\$189.00		\$189.00		\$199.00	6

Austin™	Model	Function	Finish								Case Qty
			3	L03	5	11P	15	15A	26	26D	
800AUH SMT	Single Cylinder					\$254.00	\$254.00				4
801AUH SMT	Double Cylinder					\$259.00	\$259.00				4
802AUH	Dummy					\$227.00	\$227.00				4
814AUH	Handle Only <sup>†</sup>					\$189.00	\$189.00				4

Avalon™	Model	Function	Finish								Case Qty
			3	L03	5	11P	15	15A	26	26D	
800AVH	Single Cylinder		\$254.00	\$254.00	\$254.00	\$254.00		\$254.00		\$264.00	4
800AVH SMT	Single Cylinder		\$254.00	\$254.00	\$254.00	\$254.00		\$254.00		\$264.00	4
801AVH	Double Cylinder		\$259.00	\$259.00	\$259.00	\$259.00		\$259.00		\$269.00	4
801AVH SMT	Double Cylinder		\$259.00	\$259.00	\$259.00	\$259.00		\$259.00		\$269.00	4
802AVH	Dummy		\$227.00	\$227.00	\$227.00	\$227.00		\$227.00		\$237.00	4
814AVH	Handle Only <sup>†</sup>		\$189.00	\$189.00	\$189.00	\$189.00		\$189.00		\$199.00	4

Montara™	Model	Function	Finish								Case Qty
			3	L03	5	11P	15	15A	26	26D	
553MNH SMT	Single Cylinder		\$234.00			\$254.00	\$254.00				4
554MNH SMT	Double Cylinder		\$239.00			\$259.00	\$259.00				4

**NOTE:** Handlesets ordered LIP only  
<sup>†</sup>Denotes handleset without deadbolt

**Hawthorne**



**Shelburne™**



**Tavaris®**



Hawthorne	Model	Function	Finish								Case	
			3	L03	5	11P	15	15A	26	26D	514	Qty
	800HE	Single Cylinder				\$239.00	\$239.00	\$239.00			\$249.00	4
	800HE SMT	Single Cylinder				\$239.00	\$239.00	\$239.00			\$249.00	4
	801HE	Double Cylinder				\$244.00	\$244.00	\$244.00			\$254.00	4
	801HE SMT	Double Cylinder				\$244.00	\$244.00	\$244.00			\$254.00	4
	802HE	Dummy				\$212.00	\$212.00	\$212.00			\$222.00	4
	814HE	Handle Only†				\$174.00	\$174.00	\$174.00			\$184.00	4

Shelburne™	Model	Function	Finish								Case	
			3	L03	5	11P	15	15A	26	26D	514	Qty
	800SE	Single Cylinder		\$239.00		\$239.00	\$239.00					4
	800SE SMT	Single Cylinder		\$239.00		\$239.00	\$239.00					4
	801SE	Double Cylinder		\$244.00		\$244.00	\$244.00					4
	801SE SMT	Double Cylinder		\$244.00		\$244.00	\$244.00					4
	802SE	Dummy		\$212.00		\$212.00	\$212.00					4
	814SE	Handle Only†		\$174.00		\$174.00	\$174.00					4

Tavaris®	Model	Function	Finish								Case	
			3	L03	5	11P	15	26	26D	514	Qty	
	800TVH	Single Cylinder				\$239.00	\$239.00	\$239.00	\$239.00			4
	800TVH SMT	Single Cylinder				\$239.00	\$239.00	\$239.00	\$239.00			4
	801TVH	Double Cylinder				\$244.00	\$244.00	\$244.00	\$244.00			4
	801TVH SMT	Double Cylinder				\$244.00	\$244.00	\$244.00	\$244.00			4
	802TVH	Dummy				\$212.00	\$212.00	\$212.00	\$212.00			4
	814TVH	Handle Only†				\$174.00	\$174.00	\$174.00	\$174.00			4
	815TVH	Handleset† with Vedani				\$239.00	\$239.00	\$239.00	\$239.00			6
	815TVH	Handleset† with Katara				\$239.00	\$239.00	\$239.00	\$239.00			6

**NOTE:** Handlesets ordered LIP only  
 †Denotes handleset without deadbolt

**Arlington®**



**Chelsea®**



Arlington®	Model	Function	Finish								Case	
			3	L03	5	11P	15	15A	26	26D	514	Qty
800AN	Single Cylinder		\$178.00	\$198.00	\$198.00	\$198.00	\$198.00	\$198.00				4
800AN SMT	Single Cylinder		\$178.00	\$198.00	\$198.00	\$198.00	\$198.00	\$198.00				4
801AN	Double Cylinder		\$183.00	\$203.00	\$203.00	\$203.00	\$203.00	\$203.00				4
801AN SMT	Double Cylinder		\$183.00	\$203.00	\$203.00	\$203.00	\$203.00	\$203.00				4
802AN	Dummy		\$151.00	\$171.00	\$171.00	\$171.00	\$171.00	\$171.00				4
814AN	Handle Only <sup>†</sup>			\$133.00	\$133.00	\$133.00	\$133.00	\$133.00				4
815AN	Handleset with Tustin			\$198.00		\$198.00	\$198.00					6
815AN	Handleset with Hancock			\$187.00		\$187.00	\$187.00					6

Chelsea®	Model	Function	Finish								Case	
			3	L03	5	11P	15	15A	26	26D	514	Qty
800CE	Single Cylinder		\$178.00	\$198.00	\$198.00	\$198.00	\$198.00	\$198.00	\$198.00	\$198.00		4
800CE SMT	Single Cylinder		\$178.00	\$198.00	\$198.00	\$198.00	\$198.00	\$198.00	\$198.00	\$198.00		4
801CE	Double Cylinder		\$183.00	\$203.00	\$203.00	\$203.00	\$203.00	\$203.00	\$203.00	\$203.00		4
801CE SMT	Double Cylinder		\$183.00	\$203.00	\$203.00	\$203.00	\$203.00	\$203.00	\$203.00	\$203.00		4
802CE	Dummy		\$151.00	\$171.00	\$171.00	\$171.00	\$171.00	\$171.00	\$171.00	\$171.00		4
814CE	Handle Only <sup>†</sup>			\$133.00	\$133.00	\$133.00	\$133.00	\$133.00	\$133.00	\$133.00		4
815CE	Handleset <sup>†</sup> with Tustin			\$198.00		\$198.00	\$198.00					6
815CE	Handleset <sup>†</sup> with Hancock			\$187.00		\$187.00	\$187.00					6

**NOTE:** Handlesets ordered LIP only  
<sup>†</sup>Denotes handleset without deadbolt

**INTERIOR PACKS FOR TRADITIONAL 800/801/802 HANDLESETS**

Model	Function	Series			
		Signature Lever & Laurel	Signature Knob	Kwikset Lever	Kwikset Knob
966	Single Cylinder	\$65.00	\$54.00	\$59.00	\$47.00
967	Double Cylinder	\$87.00	\$76.00	\$76.00	\$64.00
967 SMT	Double Cylinder	\$87.00	\$76.00	\$76.00	\$64.00
968	Dummy	\$54.00	\$43.00	\$49.00	\$37.00

Handleset Interior Pack Finish Options **3 L03 5 11P 15 15A 26 26D 514 Qty**

<b>Kwikset</b> <i>Signature Series</i>	Abbey Knob	•		•					•		4
	Ashfield Lever				•	•				•	12
	Avalon Lever				•	•				•	12
	Brooklane Lever				•	•	•				4
	Cameron Knob	•			•	•					4
	Circa Knob	•			•	•	•	•	•		4
	Commonwealth Lever	•		•	•	•	•	•	•	•	4
	Halifax Lever				•	•		•	•	•	12
	Hancock Knob	•		•	•	•	•	•	•	•	4
	Laurel Knob				•	•	•	•	•	•	4
	Lido Lever	•		•	•	•			•		4
	Lisbon Lever				•	•		•	•	•	12
	Milan Lever				•	•		•	•	•	12
	Montreal Lever				•	•		•	•	•	12
	Pembroke Lever	•		•	•	•	•			•	12
	Phoenix Knob	•		•	•	•					4
	Sydney Lever				•	•		•	•	•	12
	Tustin Lever	•		•	•	•	•	•	•	○	12
<b>Kwikset</b>	Aliso Knob	•			•	•		•			12
	Balboa Lever	•		•	•	•		•	•		4
	Cove Knob	•		•	•	•		•	•		4
	Delta Lever	•		•	•	•	•	•	•		12
	Dorian Lever	•		•	•	•	•	•	•		12
	Ladera Lever				•	•		•	•		12
	Polo Knob	•		•	•	•	•	•	•		4
	Tylo Knob	•		•	•	•		•	•		12

**AUSTIN INTERIOR PACKS**

Model	Function	Series			
		Signature Lever	Signature Knob	Kwikset Lever	Kwikset Knob
966 AUL	Single Cylinder	\$65.00			
967 AUL	Double Cylinder	\$87.00			
968 AUL	Dummy	\$54.00			

**SAN CLEMENTE AND CAMINO INTERIOR PACKS**

Model	Function	Series			
		Signature Lever	Signature Knob	Kwikset Lever	Kwikset Knob
971 SMT	Single Cylinder	\$65.00			
973	Dummy	\$54.00			

Handleset Interior Pack Finish Options **3 L03 5 11P 15 15A 26 26D 514 Qty**

<b>Kwikset</b> <i>Signature Series</i>	Halifax Lever				•	•		•	•	•	12
	Katara Lever				•	•		•	•		12
	Lisbon Lever				•	•		•	•	•	12
	Milan Lever				•	•		•	•	•	12
	Montreal Lever				•	•		•	•	•	12
	Sydney Lever				•	•		•	•	•	12
	Vedani Lever				•	•		•	•		12

Note: Square (SQT) or Round (RDT) rose options available

○ Only available in 966 Function



**CONTEMPORARY INTERIOR PACKS**

Model	Function	Series			
		Signature Lever	Signature Knob	Kwikset Lever	Kwikset Knob
974	Single Cylinder	\$65.00			
976 SMT	Double Cylinder	\$87.00			
977	Dummy	\$54.00			

Handleset Interior Pack Finish Options	3	L03	5	11P	15	15A	26	26D	514	Qty
<b>Kwikset</b> Katara Lever				•	•		•	•		12
<i>Signature Series</i> Vedani Lever				•	•		•	•		12

NOTE: 966, 968, 974 and 977 are not impacted by SmartKey Security cylinder.

**MONTARA INTERIOR PACKS**

Model	Function	Series			
		Signature Lever & Laurel	Signature Knob	Kwikset Lever	Kwikset Knob
978	Single Cylinder	\$68.00	\$57.00	\$68.00	\$49.00
979	Double Cylinder	\$90.00	\$79.00	\$85.00	\$66.00

Montara Handleset Interior Pack Finish Options	3	L03	5	11P	15	15A	26	26D	514	Qty
<b>Kwikset</b> Cameron Knob	•			•	•					12
<i>Signature Series</i> Circa Knob	•			•	•					12
Juno Knob	•			•	•					12
Lido Lever	•			•	•					12
Tustin Lever	•			•	•					12
<b>Kwikset</b> Cove Knob	•			•	•					12
Polo Knob	•			•	•					12
Tylo Knob	•									12

**Ashfield™**



Model	Function	Finish										Case
		3	L03	5	11P	15	15A	26	26D	514	Qty	
720ADL	Hall/Closet				\$62.00	\$62.00		\$62.00		\$65.00	12	
725ADL	Hall/Closet UL				\$68.00	\$68.00		\$68.00		\$71.00	12	
730ADL	Bed/Bath				\$65.00	\$65.00		\$65.00		\$68.00	12	
735ADL	Bed/Bath UL				\$71.00	\$71.00		\$71.00		\$74.00	12	
740ADL SMT	Entry				\$106.00	\$106.00		\$106.00		\$109.00	12	
745ADL SMT	Entry UL				\$112.00	\$112.00		\$112.00		\$115.00	12	
788ADL	Half Dummy				\$31.00	\$31.00		\$31.00		\$32.50	20	

**Austin**



Model	Function	Finish										Case
		3	L03	5	11P	15	15A	26	26D	514	Qty	
720AUL	Hall/Closet				\$62.00	\$62.00					12	
730AUL	Bed/Bath				\$65.00	\$65.00					12	
740AUL SMT	Entry				\$106.00	\$106.00					12	
788AUL	Half Dummy				\$31.00	\$31.00					20	

**Avalon™**



Model	Function	Finish										Case
		3	L03	5	11P	15	15A	26	26D	514	Qty	
720AVL	Hall/Closet				\$62.00	\$62.00		\$62.00		\$65.00	12	
725AVL	Hall/Closet UL				\$68.00	\$68.00		\$68.00		\$71.00	12	
730AVL	Bed/Bath				\$65.00	\$65.00		\$65.00		\$68.00	12	
735AVL	Bed/Bath UL				\$71.00	\$71.00		\$71.00		\$74.00	12	
740AVL SMT	Entry				\$106.00	\$106.00		\$106.00		\$109.00	12	
745AVL SMT	Entry UL				\$112.00	\$112.00		\$112.00		\$115.00	12	
788AVL	Half Dummy				\$31.00	\$31.00		\$31.00		\$32.50	20	

**Pembroke™**



Model	Function	Finish										Case
		3	L03	5	11P	15	15A	26	26D	514	Qty	
720PML	Hall/Closet	\$57.00	\$62.00	\$62.00	\$62.00	\$62.00	\$62.00	\$62.00		\$65.00	12	
725PML	Hall/Closet UL	\$63.00	\$68.00	\$68.00	\$68.00	\$68.00	\$68.00	\$68.00		\$71.00	12	
730PML	Bed/Bath	\$60.00	\$65.00	\$65.00	\$65.00	\$65.00	\$65.00	\$65.00		\$68.00	12	
735PML	Bed/Bath UL	\$66.00	\$71.00	\$71.00	\$71.00	\$71.00	\$71.00	\$71.00		\$74.00	12	
740PML SMT	Entry	\$101.00	\$106.00	\$106.00	\$106.00	\$106.00	\$106.00	\$106.00		\$109.00	12	
745PML SMT	Entry UL	\$107.00	\$112.00	\$112.00	\$112.00	\$112.00	\$112.00	\$112.00		\$115.00	12	
788PML	Half Dummy	\$28.50	\$31.00	\$31.00	\$31.00	\$31.00	\$31.00	\$31.00		\$32.50	20	

**Halifax™**

Model	Function	Finish										Case Qty
		3	L03	5	11P	15	15A	26	26D	514		
 154HFL	Hall/Closet				\$55.00	\$55.00		\$55.00	\$55.00	\$58.00	12	
155HFL	Bed/Bath				\$58.00	\$58.00		\$58.00	\$58.00	\$61.00	12	
156HFL SMT	Entry				\$99.00	\$99.00		\$99.00	\$99.00	\$102.00	12	
157HFL	Half Dummy				\$27.50	\$27.50		\$27.50	\$27.50	\$29.00	20	

**NOTE:** Can be ordered with (RDT) Round Rose or (SQT) Square Rose option. Example - 154HFL RDT 11P

**Katara®**

Model	Function	Finish										Case Qty
		3	L03	5	11P	15	15A	26	26D	514		
 720KTL	Hall/Closet				\$55.00	\$55.00		\$55.00	\$55.00		12	
725KTL	Hall/Closet UL				\$61.00	\$61.00		\$61.00	\$61.00		12	
730KTL	Bed/Bath				\$58.00	\$58.00		\$58.00	\$58.00		12	
735KTL	Bed/Bath UL				\$64.00	\$64.00		\$64.00	\$64.00		12	
740KTL SMT	Entry				\$99.00	\$99.00		\$99.00	\$99.00		12	
745KTL SMT	Entry UL				\$105.00	\$105.00		\$105.00	\$105.00		12	
788KTL	Half Dummy				\$27.50	\$27.50		\$27.50	\$27.50		20	

**Lisbon**

Model	Function	Finish										Case Qty
		3	L03	5	11P	15	15A	26	26D	514		
 154LSL	Hall/Closet				\$55.00	\$55.00		\$55.00	\$55.00	\$58.00	12	
155LSL	Bed/Bath				\$58.00	\$58.00		\$58.00	\$58.00	\$61.00	12	
156LSL SMT	Entry				\$99.00	\$99.00		\$99.00	\$99.00	\$102.00	12	
157LSL	Half Dummy				\$27.50	\$27.50		\$27.50	\$27.50	\$29.00	20	

**NOTE:** Can be ordered with (RDT) Round Rose or (SQT) Square Rose option. Example - 154LSL RDT 11P

**Milan™**

Model	Function	Finish										Case Qty
		3	L03	5	11P	15	15A	26	26D	514		
 154MIL	Hall/Closet				\$55.00	\$55.00		\$55.00	\$55.00	\$58.00	12	
155MIL	Bed/Bath				\$58.00	\$58.00		\$58.00	\$58.00	\$61.00	12	
156MIL SMT	Entry				\$99.00	\$99.00		\$99.00	\$99.00	\$102.00	12	
157MIL	Half Dummy				\$27.50	\$27.50		\$27.50	\$27.50	\$29.00	20	

**NOTE:** Can be ordered with (RDT) Round Rose or (SQT) Square Rose option. Example - 154MIL SQT 11P

**Montreal**

Model	Function	Finish										Case Qty
		3	L03	5	11P	15	15A	26	26D	514		
 154MRL	Hall/Closet				\$55.00	\$55.00		\$55.00	\$55.00	\$58.00	12	
155MRL	Bed/Bath				\$58.00	\$58.00		\$58.00	\$58.00	\$61.00	12	
156MRL SMT	Entry				\$99.00	\$99.00		\$99.00	\$99.00	\$102.00	12	
157MRL	Half Dummy				\$27.50	\$27.50		\$27.50	\$27.50	\$29.00	20	

**NOTE:** Can be ordered with (RDT) Round Rose or (SQT) Square Rose option. Example - 154MRL RDT 11P

**Sydney®**

Model	Function	Finish										Case Qty
		3	L03	5	11P	15	15A	26	26D	514		
 154SYL	Hall/Closet				\$55.00	\$55.00		\$55.00	\$55.00	\$58.00	12	
155SYL	Bed/Bath				\$58.00	\$58.00		\$58.00	\$58.00	\$61.00	12	
156SYL SMT	Entry				\$99.00	\$99.00		\$99.00	\$99.00	\$102.00	12	
157SYL	Half Dummy				\$27.50	\$27.50		\$27.50	\$27.50	\$29.00	20	

**NOTE:** Can be ordered with (RDT) Round Rose or (SQT) Square Rose option. Example - 154SYL RDT 11P

**Vedani®**

Model	Function	Finish										Case Qty
		3	L03	5	11P	15	15A	26	26D	514		
 720VDL	Hall/Closet				\$55.00	\$55.00		\$55.00	\$55.00		12	
725VDL UL	Hall/Closet UL				\$61.00	\$61.00		\$61.00	\$61.00		12	
730VDL	Bed/Bath				\$58.00	\$58.00		\$58.00	\$58.00		12	
735VDL UL	Bed/Bath UL				\$64.00	\$64.00		\$64.00	\$64.00		12	
740VDL SMT	Entry				\$99.00	\$99.00		\$99.00	\$99.00		12	
745VDL SMT	Entry UL				\$105.00	\$105.00		\$105.00	\$105.00		12	
788VDL	Half Dummy				\$27.50	\$27.50		\$27.50	\$27.50		20	

**NOTE:** Can be ordered with (RDT) Round Rose or (SQT) Square Rose option. Example - 720VDL RDT 11P

**Brooklane®**

Model	Function	Finish									Case Qty
		3	L03	5	11P	15	15A	26	26D	514	
720BRL	Hall/Closet				\$55.00	\$55.00	\$55.00				12
725BRL	Hall/Closet UL				\$61.00	\$61.00	\$61.00				12
730BRL	Bed/Bath				\$58.00	\$58.00	\$58.00				12
735BRL	Bed/Bath UL				\$64.00	\$64.00	\$64.00				12
740BRL SMT	Entry				\$99.00	\$99.00	\$99.00				12
745BRL SMT	Entry UL				\$105.00	\$105.00	\$105.00				12
788BRL	Half Dummy				\$27.50	\$27.50	\$27.50				20

**Commonwealth®**

Model	Function	Finish									Case Qty
		3	L03	5	11P	15	15A	26	26D	514	
720CHL	Hall/Closet	\$50.00	\$55.00	\$55.00	\$55.00	\$55.00	\$55.00	\$55.00	\$55.00	\$58.00	12
725CHL	Hall/Closet UL	\$56.00	\$61.00	\$61.00	\$61.00	\$61.00	\$61.00	\$61.00	\$61.00	\$64.00	12
730CHL	Bed/Bath	\$53.00		\$58.00	\$58.00	\$58.00	\$58.00	\$58.00	\$58.00	\$61.00	12
735CHL	Bed/Bath UL	\$59.00		\$64.00	\$64.00	\$64.00	\$64.00	\$64.00	\$64.00	\$67.00	12
740CHL	Entry	\$94.00	\$99.00	\$99.00	\$99.00	\$99.00	\$99.00	\$99.00	\$99.00	\$102.00	12
740CHL SMT	Entry	\$94.00	\$99.00	\$99.00	\$99.00	\$99.00	\$99.00	\$99.00	\$99.00	\$102.00	12
745CHL	Entry UL	\$100.00	\$105.00	\$105.00	\$105.00	\$105.00	\$105.00	\$105.00	\$105.00	\$108.00	12
745CHL SMT	Entry UL	\$100.00	\$105.00	\$105.00	\$105.00	\$105.00	\$105.00	\$105.00	\$105.00	\$108.00	12
788CHL	Half Dummy	\$25.00		\$27.50	\$27.50	\$27.50	\$27.50	\$27.50	\$27.50	\$29.00	20

**Lido®**

Model	Function	Finish									Case Qty
		3	L03	5	11P	15	15A	26	26D	514	
720LL	Hall/Closet	\$41.00		\$46.00	\$46.00	\$46.00	\$46.00		\$46.00		20
725LL	Hall/Closet UL	\$47.00		\$52.00	\$52.00	\$52.00	\$52.00		\$52.00		20
730LL	Bed/Bath	\$44.00		\$49.00	\$49.00	\$49.00	\$49.00		\$49.00		20
735LL	Bed/Bath UL	\$50.00		\$55.00	\$55.00	\$55.00	\$55.00		\$55.00		20
740LL SMT	Entry	\$65.00		\$70.00	\$70.00	\$70.00	\$70.00		\$70.00		20
741LL SMT	Entry, Free Interior	\$70.00		\$75.00	\$75.00	\$75.00	\$75.00		\$75.00		20
745LL SMT	Entry UL	\$71.00		\$76.00	\$76.00	\$76.00	\$76.00		\$76.00		20
746LL SMT	Entry, Free Interior UL	\$76.00		\$81.00	\$81.00	\$81.00	\$81.00		\$81.00		20
750LL SMT	Vestibule	\$70.00		\$75.00	\$75.00	\$75.00	\$75.00		\$75.00		20
755LL SMT	Vestibule UL	\$76.00		\$81.00	\$81.00	\$81.00	\$81.00		\$81.00		20
788LL	Half Dummy	\$20.50		\$23.00	\$23.00	\$23.00	\$23.00		\$23.00		20

**Tustin™**

Model	Function	Finish									Case Qty
		3	L03	5	11P	15	15A	26	26D	514	
720TNL	Hall/Closet	\$41.00		\$46.00	\$46.00	\$46.00	\$46.00	\$46.00	\$46.00	\$49.00	20
725TNL	Hall/Closet UL	\$47.00		\$52.00	\$52.00	\$52.00	\$52.00	\$52.00	\$52.00	\$55.00	20
730TNL	Bed/Bath	\$44.00		\$49.00	\$49.00	\$49.00	\$49.00	\$49.00	\$49.00	\$52.00	20
735TNL	Bed/Bath UL	\$50.00		\$55.00	\$55.00	\$55.00	\$55.00	\$55.00	\$55.00		20
740TNL	Entry			\$70.00	\$70.00	\$70.00	\$70.00	\$70.00	\$70.00		20
740TNL SMT	Entry	\$65.00		\$70.00	\$70.00	\$70.00	\$70.00	\$70.00	\$70.00	\$73.00	20
741TNL	Entry, Free Interior	\$70.00		\$75.00	\$75.00	\$75.00	\$75.00	\$75.00	\$75.00		20
741TNL SMT	Entry, Free Interior	\$70.00		\$75.00	\$75.00	\$75.00	\$75.00	\$75.00	\$75.00		20
745TNL	Entry UL	\$71.00		\$76.00	\$76.00	\$76.00	\$76.00	\$76.00	\$76.00		20
745TNL SMT	Entry UL	\$71.00		\$76.00	\$76.00	\$76.00	\$76.00	\$76.00	\$76.00		20
746TNL	Entry, Free Interior UL	\$76.00		\$81.00	\$81.00	\$81.00	\$81.00	\$81.00	\$81.00		20
746TNL SMT	Entry, Free Interior UL	\$76.00		\$81.00	\$81.00	\$81.00	\$81.00	\$81.00	\$81.00		20
750TNL	Vestibule	\$70.00		\$75.00	\$75.00	\$75.00	\$75.00	\$75.00	\$75.00		20
750TNL SMT	Vestibule	\$70.00		\$75.00	\$75.00	\$75.00	\$75.00	\$75.00	\$75.00		20
755TNL	Vestibule UL	\$76.00		\$81.00	\$81.00	\$81.00	\$81.00	\$81.00	\$81.00		20
755TNL SMT	Vestibule UL	\$76.00		\$81.00	\$81.00	\$81.00	\$81.00	\$81.00	\$81.00		20
788TNL	Half Dummy	\$20.50		\$23.00	\$23.00	\$23.00	\$23.00	\$23.00	\$23.00	\$24.50	20

**Laurel®**



Model	Function	Finish										Case Qty
		3	L03	5	11P	15	15A	26	26D	514		
720L	Hall/Closet				\$51.00	\$51.00	\$51.00	\$51.00			\$54.00	12
730L	Bed/Bath				\$54.00	\$54.00	\$54.00	\$54.00			\$57.00	12
740L SMT	Entry				\$76.00	\$76.00	\$76.00	\$76.00			\$79.00	12
788L	Half Dummy				\$25.50	\$25.50	\$25.50	\$25.50			\$27.00	20

**Circa®**



Model	Function	Finish										Case Qty
		3	L03	5	11P	15	15A	26	26D	514		
720CA	Hall/Closet	\$27.00			\$32.00	\$32.00	\$32.00	\$32.00	\$32.00			12
725CA	Hall/Closet UL	\$33.00			\$38.00	\$38.00	\$38.00	\$38.00	\$38.00			12
730CA	Bed/Bath	\$30.00			\$35.00	\$35.00	\$35.00	\$35.00	\$35.00			12
735CA	Bed/Bath UL	\$36.00			\$41.00	\$41.00	\$41.00	\$41.00	\$41.00			12
740CA SMT	Entry	\$52.00			\$57.00	\$57.00	\$57.00	\$57.00	\$57.00			12
741CA SMT	Entry, Free Interior	\$57.00			\$62.00				\$62.00			12
745CA SMT	Entry UL	\$58.00			\$63.00	\$63.00	\$63.00	\$63.00	\$63.00			12
746CA SMT	Entry, Free Interior UL	\$63.00			\$68.00				\$68.00			12
750CA SMT	Vestibule	\$57.00			\$62.00				\$62.00			12
755CA	Vestibule UL	\$63.00			\$68.00				\$68.00			12
788CA	Half Dummy	\$13.50			\$16.00	\$16.00	\$16.00	\$16.00	\$16.00			20

**Hancock®**



Model	Function	Finish										Case Qty
		3	L03	5	11P	15	15A	26	26D	514		
720H	Hall/Closet	\$27.00	\$32.00	\$32.00	\$32.00	\$32.00	\$32.00	\$32.00	\$32.00	\$32.00	\$35.00	12
725H	Hall/Closet UL	\$33.00	\$38.00	\$38.00	\$38.00	\$38.00	\$38.00	\$38.00	\$38.00	\$38.00	\$41.00	12
730H	Bed/Bath	\$30.00		\$35.00	\$35.00	\$35.00	\$35.00	\$35.00	\$35.00	\$35.00	\$38.00	12
735H	Bed/Bath UL	\$36.00		\$41.00	\$41.00	\$41.00	\$41.00	\$41.00	\$41.00	\$41.00	\$44.00	12
740H	Entry	\$52.00	\$57.00	\$57.00	\$57.00	\$57.00	\$57.00	\$57.00	\$57.00	\$57.00	\$60.00	12
740H SMT	Entry	\$52.00	\$57.00	\$57.00	\$57.00	\$57.00	\$57.00	\$57.00	\$57.00	\$57.00	\$60.00	12
741H	Entry, Free Interior	\$57.00	\$62.00	\$62.00	\$62.00	\$62.00	\$62.00	\$62.00	\$62.00	\$62.00	\$65.00	12
741H SMT	Entry, Free Interior	\$57.00	\$62.00	\$62.00	\$62.00	\$62.00	\$62.00	\$62.00	\$62.00	\$62.00	\$65.00	12
745H	Entry UL	\$58.00	\$63.00	\$63.00	\$63.00	\$63.00	\$63.00	\$63.00	\$63.00	\$63.00	\$66.00	12
745H SMT	Entry UL	\$58.00	\$63.00	\$63.00	\$63.00	\$63.00	\$63.00	\$63.00	\$63.00	\$63.00	\$66.00	12
746H	Entry, Free Interior UL	\$63.00	\$68.00	\$68.00	\$68.00	\$68.00	\$68.00	\$68.00	\$68.00	\$68.00		12
746H SMT	Entry, Free Interior UL	\$63.00	\$68.00	\$68.00	\$68.00	\$68.00	\$68.00	\$68.00	\$68.00	\$68.00		12
750H	Vestibule	\$57.00	\$62.00	\$62.00	\$62.00	\$62.00	\$62.00	\$62.00	\$62.00	\$62.00	\$65.00	12
750H SMT	Vestibule	\$57.00	\$62.00	\$62.00	\$62.00	\$62.00	\$62.00	\$62.00	\$62.00	\$62.00	\$65.00	12
755H	Vestibule UL	\$63.00	\$68.00	\$68.00	\$68.00	\$68.00	\$68.00	\$68.00	\$68.00	\$68.00	\$71.00	12
755H SMT	Vestibule UL	\$63.00	\$68.00	\$68.00	\$68.00	\$68.00	\$68.00	\$68.00	\$68.00	\$68.00	\$71.00	12
788H	Half Dummy	\$13.50	\$16.00	\$16.00	\$16.00	\$16.00	\$16.00	\$16.00	\$16.00	\$16.00	\$17.50	20

**Phoenix®**



Model	Function	Finish										Case Qty
		3	L03	5	11P	15	15A	26	26D	514		
720PE	Hall/Closet	\$27.00		\$32.00	\$32.00	\$32.00						12
730PE	Bed/Bath	\$30.00		\$35.00	\$35.00	\$35.00						12
740PE SMT	Entry	\$52.00		\$57.00	\$57.00	\$57.00						12
788PE	Half Dummy	\$13.50		\$16.00	\$16.00	\$16.00						20

**Abbey®**



Model	Function	Finish									Case Qty
		3	L03	5	11P	15	15A	26	26D	514	
720A	Hall/Closet	\$25.00		\$30.00					\$30.00		12
725A	Hall/Closet UL	\$31.00		\$36.00					\$36.00		12
730A	Bed/Bath	\$28.00		\$33.00					\$33.00		12
735A	Bed/Bath UL	\$34.00		\$39.00					\$39.00		12
740A	Entry	\$50.00		\$55.00					\$55.00		12
740A SMT	Entry	\$50.00		\$55.00					\$55.00		12
741A	Entry, Free Interior	\$55.00		\$60.00					\$60.00		12
741A SMT	Entry, Free Interior	\$55.00		\$60.00					\$60.00		12
745A	Entry UL	\$56.00		\$61.00					\$61.00		12
745A SMT	Entry UL	\$56.00		\$61.00					\$61.00		12
746A	Entry, Free Interior UL	\$61.00		\$66.00					\$66.00		12
746A SMT	Entry, Free Interior UL	\$61.00		\$66.00					\$66.00		12
750A	Vestibule	\$55.00		\$60.00					\$60.00		12
750A SMT	Vestibule	\$55.00		\$60.00					\$60.00		12
755A	Vestibule UL	\$61.00		\$66.00					\$66.00		12
755A SMT	Vestibule UL	\$61.00		\$66.00					\$66.00		12
788A	Half Dummy	\$12.50		\$15.00					\$15.00		20

**Cameron®**



Model	Function	Finish									Case Qty
		3	L03	5	11P	15	15A	26	26D	514	
720CN	Hall/Closet	\$25.00			\$30.00	\$30.00					30
730CN	Bed/Bath	\$28.00			\$33.00	\$33.00					30
740CN	Entry	\$50.00			\$55.00	\$55.00					30
740CN SMT	Entry	\$50.00			\$55.00	\$55.00					30
741CN	Entry, Free Interior	\$55.00			\$60.00	\$60.00					30
741CN SMT	Entry, Free Interior	\$55.00			\$60.00	\$60.00					30
750CN	Vestibule	\$55.00			\$60.00	\$60.00					30
750CN SMT	Vestibule	\$55.00			\$60.00	\$60.00					30
788CN	Half Dummy	\$12.50			\$15.00	\$15.00					20

**980/985**



Model	Function	Finish										Case Qty
		3	L03	5	11P	15	15A	26	26D	514		
980	Single Cylinder		\$68.00	\$68.00	\$68.00	\$68.00					\$71.00	12
980 SMT	Single Cylinder		\$68.00	\$68.00	\$68.00	\$68.00					\$71.00	12
982	Single Cylinder UL		\$74.00	\$74.00	\$74.00	\$74.00					\$77.00	12
982 SMT	Single Cylinder UL		\$74.00	\$74.00	\$74.00	\$74.00					\$77.00	12
984	Double Cylinder UL		\$99.00	\$99.00	\$99.00	\$99.00					\$102.00	12
984 SMT	Double Cylinder UL		\$99.00	\$99.00	\$99.00	\$99.00					\$102.00	12
985	Double Cylinder		\$93.00	\$93.00	\$93.00	\$93.00					\$96.00	12
985 SMT	Double Cylinder		\$93.00	\$93.00	\$93.00	\$93.00					\$96.00	12

**Uptown Deadbolt**



Model	Function	Finish										Case Qty
		3	L03	5	11P	15	15A	26	26D	514		
258 RDT SMT	Single Cylinder				\$68.00	\$68.00		\$68.00	\$68.00	\$71.00	12	

**Downtown Deadbolt**



Model	Function	Finish										Case Qty
		3	L03	5	11P	15	15A	26	26D	514		
258 SQT SMT	Single Cylinder				\$68.00	\$68.00		\$68.00	\$68.00	\$71.00	12	

**Austin Deadbolt**



Model	Function	Finish										Case Qty
		3	L03	5	11P	15	15A	26	26D	514		
980AUD SMT	Single Cylinder				\$68.00	\$68.00					12	
985AUD SMT	Double Cylinder				\$93.00	\$93.00					12	

**780/785**



Model	Function	Finish										Case Qty
		3	L03	5	11P	15	15A	26	26D	514		
780	Single Cylinder	\$50.00	\$58.00	\$58.00	\$58.00	\$58.00	\$58.00	\$58.00	\$58.00	\$58.00	12	
780 SMT	Single Cylinder	\$50.00	\$58.00	\$58.00	\$58.00	\$58.00	\$58.00	\$58.00	\$58.00	\$58.00	12	
782	Single Cylinder UL	\$56.00	\$64.00	\$64.00	\$64.00	\$64.00	\$64.00	\$64.00	\$64.00	\$64.00	12	
782 SMT	Single Cylinder UL	\$56.00	\$64.00	\$64.00	\$64.00	\$64.00	\$64.00	\$64.00	\$64.00	\$64.00	12	
784	Double Cylinder UL	\$81.00	\$89.00	\$89.00	\$89.00	\$89.00	\$89.00	\$89.00	\$89.00	\$89.00	12	
784 SMT	Double Cylinder UL	\$81.00	\$89.00	\$89.00	\$89.00	\$89.00	\$89.00	\$89.00	\$89.00	\$89.00	12	
785	Double Cylinder	\$75.00	\$83.00	\$83.00	\$83.00	\$83.00	\$83.00	\$83.00	\$83.00	\$83.00	12	
785 SMT	Double Cylinder	\$75.00	\$83.00	\$83.00	\$83.00	\$83.00	\$83.00	\$83.00	\$83.00	\$83.00	12	

**Halifax Deadbolt**



Model	Function	Finish										Case Qty
		3	L03	5	11P	15	15A	26	26D	514		
158 SQT	Single Cylinder				\$58.00	\$58.00		\$58.00	\$58.00	\$61.00	12	
158 SQT SMT	Single Cylinder				\$58.00	\$58.00		\$58.00	\$58.00	\$61.00	12	
159 SQT	Double Cylinder				\$83.00	\$83.00		\$83.00	\$83.00	\$86.00	12	
159 SQT SMT	Double Cylinder				\$83.00	\$83.00		\$83.00	\$83.00	\$86.00	12	

**Milan Deadbolt**



Model	Function	Finish										Case Qty
		3	L03	5	11P	15	15A	26	26D	514		
158 RDT	Single Cylinder				\$58.00	\$58.00		\$58.00	\$58.00	\$61.00	12	
158 RDT SMT	Single Cylinder				\$58.00	\$58.00		\$58.00	\$58.00	\$61.00	12	
159 RDT	Double Cylinder				\$83.00	\$83.00		\$83.00	\$83.00	\$86.00	12	
159 RDT SMT	Double Cylinder				\$83.00	\$83.00		\$83.00	\$83.00	\$86.00	12	

**Gatelatch**



Model	Function	Finish										Case Qty
		3	L03	5	11P	15	15A	26	26D	514		
598	Single Cylinder	\$72.00	\$80.00	\$80.00		\$80.00	\$80.00		\$80.00		12	
599	Double Cylinder	\$97.00				\$105.00			\$105.00		12	
599 SMT	Double Cylinder	\$97.00		\$105.00		\$105.00			\$105.00		12	

**KWIKSET SIGNATURE SERIES HANDLESETS**

Door Prep	Deadbolt: Cross Bore 2-1/8" or 1-1/2". Edge Bore 1". Handle: Cross Bore 2-1/8". Edge Bore 1".
Backset	Deadbolt: Adjustable to 2-3/8" or 2-3/4". Handle: Adjustable to 2-3/8" or 2-3/4".
Door	1-3/4" doors standard. 2-1/4" doors optional.
Thickness	Not designed for use on 1-3/8" doors.
Cylinder	SmartKey Security or Pin & Tumbler
Faceplate	1" x 2-1/4". Specify round corner, square corner or drive-in.
Strikes	Deadbolt: 1-1/4" x 3-5/8". Specify round corner or square corner. Others options available. Handle: 2-1/4" full lip. Specify round corner or square corner. Other options available.
Bolt	Deadbolt: 1" throw. Handle: 1/2" throw.
Door Handing	Reversible for right or left-hand doors.
ANSI/BHMA	Deadbolt is Grade 1 Certified. Montara Deadbolt is
ADA	Grade 2 Certified. N/A
UL	Optional 1/3 hour UL* fire rating for all functions except 802, 819 and 502

**KWIKSET SIGNATURE SERIES LEVERS**

Door Prep	Cross Bore 2-1/8" Edge Bore 1" Latch Face 1" x 2-1/4"
Backset	Adjustable 2-3/8" or 2-3/4".
Door Thickness	1-3/8" – 1-3/4" doors standard. 2-1/4" doors optional on 720 and 740 models.
Cylinder	SmartKey Security or Pin & Tumbler.
Rose	Specify round or square rose - HFL, LSL, MRL, SYL, MIL, VDL
Faceplate	1" x 2-1/4". Specify round corner, square corner or drive-in.
Strikes	2-1/4" full lip. Specify round corner or square corner. Other options available.
Bolt	1/2" throw
Door Handing	Specify handing only with inactive levers
ANSI/BHMA	Grade 2 Certified.
ADA	Families of MRL, SYL, LSL, MIL, HFL in Functions Passage, Privacy and Entry are in compliance with the American National Standards Institute (ANSI A117.1) and the Americans with Disabilities Act (ADA).
UL	Meets UL 3 hour fire rating for 725, 735, 745, 746, 749, 755 Optional UL* 1/3 hour fire rating for all functions

**KWIKSET SIGNATURE SERIES KNOBS**

Door Prep	Cross Bore: 2-1/8" Edge Bore: 1" Latch Face: 1" x 2-1/4".
Backset	Adjustable to 2-3/8" or 2-3/4". UL 2-3/4" standard 2-3/8" optional.
Door	1-3/8" – 1-3/4" doors standard.
Thickness	2-1/4" doors optional on 720 and 740 models only.
Cylinder	SmartKey Security or Pin & Tumbler.
Faceplate	1" x 2-1/4". Specify round corner, square corner or drive-in.
Strikes	2-1/4" full lip. Specify round corner or square corner. Other options available.
Bolt	1/2" throw.
Door Handing	Reversible for right- or left-hand doors.
ANSI/BHMA	Grade 2 Certified
ADA	N/A
UL	Meets UL 3 hour fire rating for 725, 735, 745, 746, 749 and 755. Optional UL* 1/3 hour fire rating for all functions

**KWIKSET SIGNATURE SERIES 780-785 DEADBOLTS**

Door Prep	780, 785: Crossbore 2-1/8" or 1-1/2". Edge Bore 1". 782, 784: Crossbore 2-1/8". Edge Bore 1".
Backset	Adjustable 2-3/8" or 2-3/4" standard.
Door Thickness	1-3/8" – 1-3/4" doors standard. 1-7/8" – 2-1/4" optional.
Cylinder	SmartKey Security or 6-pin removable core.
Faceplate	1" x 2-1/4". Specify round corner, square corner or drive-in.
Strikes	1-1/4" x 3-5/8". Specify round corner or square corner. Other options available.
Bolt	1" throw.
Door Handing	Reversible for right or left-hand doors.
ANSI/BHMA	Grade 2 Certified.
ADA	Interior turn pieces are in compliance with the American National Standards Institute (ANSI A117.1) and the Americans with Disabilities Act (ADA).
UL	Meets UL 3 hour fire rating for 782 & 784 Optional UL* 1/3 hour fire rating for all functions

\*Optional UL 1/3 hour list price charge is \$2.50.



### KWIKSET SIGNATURE SERIES 158/159 CONTEMPORARY DEADBOLTS

Door Prep	Cross Bore 2-1/8" or 1-1/2". Edge Bore 1".
Backset	Adjustable 2-3/8" or 2-3/4".
Door Thickness	SMT 1-3/8" – 1-3/4".
Cylinder	SmartKey Security or Pin & Tumbler (158 and 159)
Rose	Specify round or square rose
Strikes	1-1/4" x 3-5/8" Square or Round Corner.
Bolt	1" Throw Steel.
ANSI/BHMA	A156.36 Grade 2
ADA	Interior turn pieces are in compliance with the American National Standards Institute (ANSI A117.1) and the Americans with Disabilities Act (ADA).
UL	Optional UL* 1/3 hour fire rating for all functions.

### KWIKSET SIGNATURE SERIES 980/985 DEADBOLTS

Door Prep	980, 985: Crossbore 2-1/8" or 1-1/2". Edge Bore 1". 982, 984: Crossbore 2-1/8". Edge Bore 1".
Backset	Adjustable 2-3/8" or 2-3/4".
Door Thickness	1-3/8" – 1-3/4" doors standard. 1-7/8" – 2-1/4" optional.
Cylinder	SmartKey Security or Pin & Tumbler.
Faceplate	1" x 2-1/4". Specify round corner, square corner or drive-in.
Strikes	Standard: Grade 2, 1-1/4" x 3-5/8" Specify round corner or square corner. For Grade 1 order 5278 Strike option and Ultra Strike Door Jamb Brace. Other options available.
Bolt	1" throw.
Door Handing	Reversible for right or left-hand doors.
ANSI/BHMA	Grade 1 Certified.
ADA	Interior turn pieces are in compliance with the American National Standards Institute (ANSI A117.1) and the Americans with Disabilities Act (ADA).
UL	Meets UL 3 hour fire rating for 982 and 984 Optional UL* 1/3 hour fire rating for all functions

### KWIKSET SIGNATURE SERIES 258 UPTOWN & DOWNTOWN CONTEMPORARY DEADBOLTS

Door Prep	Cross Bore 2-1/8". Edge Bore 1".
Backset	Adjustable 2-3/8" or 2-3/4".
Door Thickness	1-3/8" – 1-3/4" Standard. Thick door service part available for up to 2'1/4".
Cylinder	Smartkey Security
Faceplate	1" x 2-1/4" Square, round, or drive in.
Rose	Specify round (Uptown) or square (Downtown) rose.
Strikes	1" x 2-1/4" square or round corner.
Bolt	1" Throw Steel.
ANSI/BHMA	A156.36 Grade 1
ADA	Interior turn pieces are in compliance with the American National Standards Institute (ANSI A117.1) and the Americans with Disabilities Act (ADA).
UL	Optional UL* 1/3 hour fire rating for all functions.

\*Optional UL 1/3 hour list price charge is \$2.50.

**KWIKSET SIGNATURE SERIES HANDLESET**

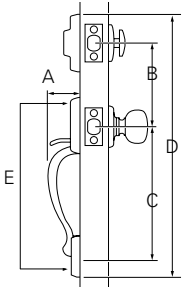

Design	A	B	C	D	E
Amherst®	3"	5-1/2"	8-13/32"	18-23/32"	18-18/25"
Arlington®	2-1/2"	5-1/2"	11"	19-1/16"	15"
Camino	2-15/16"	5-1/2"	8-13/32"	17-5/8"	13"
			9-11/16"		
Ashfield™	2-31/32"	5-1/2"	8-13/32"	17-3/4"	14-11/25"
Austin	3-1/8"	5-1/2"	8-13/32"	18-13/32"	13-17/20"
			9-1/8"		
			9-11/16"		
Avalon™	2-7/8"	5-1/2"	8-13/32"	18-5/32"	12-13/20"
Chelsea®	2-3/16"	5-1/2"	9-11/16"	18-1/2"	13"
Hawthorne™	2-7/8"	5-1/2"	8-13/32"	17-7/16"	13-2/5"
Montara™	2-5/8"	5-1/2"	8-13/32"	17-5/8"	12-1/5"
			9-1/8"		
			9-11/16"		
San Clemente	2-5/8"	5-1/2"	8-13/32"	17-29/32"	13-7/16"
			9-11/16"		
Shelburne™	2-7/8"	5-1/2"	8-13/32"	18-1/4"	12-3/5"
Tavaris	2-17/32"	5-1/2"	8-13/32"	18"	12-19/25"

**KWIKSET SIGNATURE SERIES KNOBS**

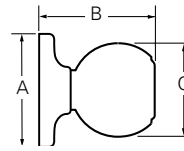

Design	A	B	C
Abbey®	2-5/8"	2-17/16"	2"
Cameron®	2-5/8"	2-13/32"	2-1/8"
Circa®	2-5/8"	2-31/32"	2-1/8"
Hancock®	2-5/8"	2-1/2"	2-3/8"
Laurel®	2-5/8"	2-7/16"	2-7/16"
Phoenix®	2-5/8"	2-1/2"	2-3/16"

**KWIKSET SIGNATURE SERIES LEVERS**

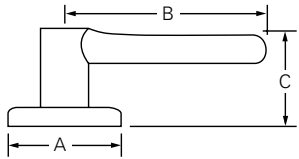

Design	A	B	C	C (Keyed)
Ashfield™	2-5/8"	4-3/16"	2-9/16"	2-9/16"
Austin	2-13/16"	4-1/8"	2-2/3"	2-3/4"
Avalon™	2-5/8"	4-1/4"	2-17/32"	2-7/16"
Brooklane®	2-5/8"	4-3/16"	2-11/16"	2-11/16"
Commonwealth®	2-5/8"	4-7/32"	2-7/16"	2-7/16"
Halifax	2-5/8"	4-15/32"	2-19/32"	2-3/8"
Katara	2-4/9"	4-4/9"	2-2/3"	2-3/4"
Lido®	2-5/8"	3-3/4"	1-29/32"	2-15/32"
Lisbon	2-5/8"	4-5/32"	2-9/16"	2-3/8"
Milan	2-5/8"	4-5/32"	2-9/16"	2-3/8"
Montreal	2-5/8"	4-1/4"	2-5/8"	2-11/16"
Pembroke™	2-5/8"	4-7/32"	2-23/32"	2-23/32"
Sydney®	2-5/8"	4-1/4"	2-3/4"	2-3/8"
Tustin®	2-5/8"	4-7/32"	2-3/32"	2-19/32"
Vedani	2-2/3"	4-5/8"	2-1/2"	2-3/4"

**KWIKSET SIGNATURE SERIES 158-159 DEADBOLT**

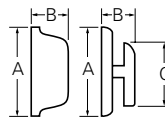

Round Design	A	B	C
158 Interior	2-17/32"	1-13/32"	1-11/16"
158 Exterior	2-17/32"	15/16"	
159 Interior	2-17/32"	1-13/32"	1-11/16"
159 Exterior	2-17/32"	15/16"	

Square Design	A	B	C
158 Interior	2-17/32"	1-13/32"	1-11/16"
158 Exterior	2-19/32"	15/16"	
159 Interior	2-17/32"	1-13/32"	1-11/16"
159 Exterior	2-19/32"	15/16"	

**KWIKSET SIGNATURE SERIES AUSTIN 980-985 DEADBOLT**

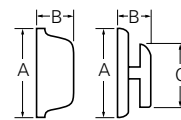

Design	A	B	C
980 Interior	3-13/32"	1-1/2"	1-7/16"
980 Exterior	3-17/32"	1-1/16"	
985 Interior	3-17/32"	1-1/16"	
985 Exterior	3-17/32"	1-1/16"	

**KWIKSET SIGNATURE SERIES 980-985 DEADBOLT**



Design	A	B	C
980 Interior	2-19/32"	1-5/32"	1-13/16"
980 Exterior	2-5/8"	1-1/32"	
985 Interior	2-5/8"	1-1/32"	
985 Exterior	2-5/8"	1-1/32"	

**KWIKSET SIGNATURE SERIES 780-785 DEADBOLT**



Design	A	B	C
780, 782 Interior	2-1/2"	15/16"	1-25/32"
780, 782 Exterior	2-5/8"	1-1/8"	
784, 785 Interior	2-5/8"	1-1/8"	
784, 785 Exterior	2-5/8"	1-1/8"	

**KWIKSET SIGNATURE SERIES 258 UPTOWN & DOWNTOWN DEADBOLT**

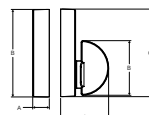

Design	A	B	C
258 Round Interior	1-3/8"	1-21/32"	2-5/8"
258 Round Exterior	9/16"	2-5/8"	

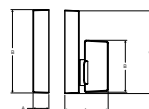

Design	A	B	C
258 Square Interior	1-7/16"	1-21/32"	2-5/8"
258 Square Exterior	1/2"	2-5/8"	

**Trusted Security**



- ANSI/BHMA Grade 3
- Easy Installation
- Available with SmartKey® Security
- Most Recognized Styles

**Warranty**

- Lifetime Mechanical
- Lifetime Finish



Amador



Bellevue™



Dakota™



Aliso™



Cove™



Polo®



Tylo®



Balboa™



Delta®



660 CRR  
Contemporary



Dorian®



Ladera®



660/665 Deadbolt

**Amador**



**Bellevue™**



**Dakota™**



Amador	Model	Function	Finish							Case		
			3	L03	5	11P	15	15A	26	26D	Qty	
	687AMD SMT	Single Cylinder SMT				\$151.00	\$151.00			\$151.00	\$135.00	6
	689AMD SMT	Double Cylinder SMT				\$156.00	\$156.00			\$156.00	\$140.00	6
	699AMD	Dummy				\$136.00	\$136.00			\$136.00	\$120.00	6
	898AMD†	Handle Only				\$115.00	\$115.00			\$115.00		6

Bellevue™	Model	Function	Finish							Case		
			3	L03	5	11P	15	15A	26	26D	Qty	
	687BW	Single Cylinder	\$100.00		\$100.00	\$116.00	\$116.00			\$100.00		6
	687BW SMT	Single Cylinder	\$105.00		\$105.00	\$121.00	\$121.00			\$105.00		6
	689BW	Double Cylinder	\$105.00		\$105.00	\$121.00	\$121.00			\$105.00		6
	689BW SMT	Double Cylinder	\$110.00		\$110.00	\$126.00	\$126.00			\$110.00		6
	699BW	Dummy	\$90.00		\$90.00	\$106.00	\$106.00			\$90.00		6
	898BW†	Handle Only				\$85.00	\$85.00					6

Dakota™	Model	Function	Finish							Case		
			3	L03	5	11P	15	15A	26	26D	Qty	
	687DA	Single Cylinder	\$100.00		\$100.00	\$116.00	\$116.00			\$100.00		6
	687DA SMT	Single Cylinder	\$105.00		\$105.00	\$121.00	\$121.00			\$105.00		6
	689DA	Double Cylinder	\$105.00		\$105.00	\$121.00	\$121.00			\$105.00		6
	689DA SMT	Double Cylinder	\$110.00		\$110.00	\$126.00	\$126.00			\$110.00		6
	699DA	Dummy	\$90.00		\$90.00	\$106.00	\$106.00			\$90.00		6
	898DA†	Handle Only				\$85.00	\$85.00					6
	899DA†	Handleset† with Balboa™				\$140.00	\$140.00					6

†Denotes handleset without deadbolt

**INTERIOR PACK FUNCTION OPTIONS**

Model	Function	Series			
		Signature Lever & Laurel	Signature Knob	Kwikset Lever	Kwikset Knob
604	Single Cylinder	\$56.00	\$45.00	\$51.00	\$41.00
605	Double Cylinder	\$75.00	\$64.00	\$63.00	\$53.00
605 SMT	Double Cylinder	\$80.00	\$69.00	\$68.00	\$58.00
606	Dummy	\$47.00	\$36.00	\$41.00	\$31.00

NOTE:604 and 606 interior packs not impacted by SmartKey Security.

Kwikset Handleset & Interior Pack Finish Options		3	L03	5	11P	15	15A	26	26D	Qty
<b>Kwikset</b> <i>Signature Series</i>	Abbey Knob	•		•				•	•	4
	Cameron Knob	•		•	•	•	•	•		4
	Circa Knob	•			•	•	•	•	•	4
	Hancock Knob	•		•	•	•	•	•	•	4
	Laurel Knob				•	•	•	•		4
	Lido Lever	•		•		•	•		•	4
	Tustin Lever	•		•	•	•	•	•	•	12
	<b>Kwikset</b>	Aliso Knob	•			•	•		•	
Balboa Lever		•		•	•	•		•	•	12
Cove Knob					•	•		•	•	12
Delta Lever		•		•	•	•	•	•	•	12
Dorian Lever		•		•	•	•	•	•	•	12
Ladera Lever					•	•		•	•	12
Polo Knob		•		•	•	•	•	•	•	12
Tylo Knob		•		•		•		•	•	12

**Balboa™**

	Model	Function	Finish							Case Qty	
			3	L03	5	11P	15	15A	26		26D
	200BL	Hall/Closet	\$35.00		\$35.00	\$38.00	\$38.00		\$38.00	\$35.00	20
	300BL	Bed/Bath	\$38.00		\$38.00	\$41.00	\$41.00		\$41.00	\$38.00	20
	405BL	Keyed Lever	\$53.00		\$53.00	\$56.00	\$56.00		\$56.00	\$53.00	20
	405BL SMT	Keyed Lever	\$58.00		\$58.00	\$61.00	\$61.00		\$61.00	\$58.00	20
	488BL	Half Dummy	\$17.50		\$17.50	\$20.50	\$20.50		\$20.50	\$17.50	20

**Delta®**

	Model	Function	Finish							Case Qty	
			3	L03	5	11P	15	15A	26		26D
	200DL	Hall/Closet	\$35.00		\$35.00	\$38.00	\$38.00	\$38.00	\$38.00	\$35.00	20
	300DL	Bed/Bath	\$38.00		\$38.00	\$41.00	\$41.00	\$41.00	\$41.00	\$38.00	20
	405DL	Keyed Lever	\$53.00		\$53.00	\$56.00	\$56.00	\$56.00	\$56.00	\$53.00	20
	405DL SMT	Keyed Lever	\$58.00		\$58.00	\$61.00	\$61.00	\$61.00	\$61.00	\$58.00	20
	406DL	Free Interior, Keyed Lever	\$56.00		\$56.00			\$59.00	\$59.00	\$56.00	20
	406DL SMT	Free Interior, Keyed Lever	\$61.00		\$61.00			\$64.00	\$64.00	\$61.00	20
	409DL	Keyed Lever UL	\$59.00		\$59.00	\$62.00	\$62.00	\$62.00	\$62.00	\$59.00	20
	409DL SMT	Keyed Lever UL	\$64.00		\$64.00	\$67.00	\$67.00	\$67.00	\$67.00	\$64.00	20
	412DL	Vestibule Keyed Lever UL	\$62.00		\$62.00			\$65.00	\$65.00	\$62.00	20
	412DL SMT	Vestibule Keyed Lever UL	\$67.00		\$67.00			\$70.00	\$70.00	\$67.00	20
	413DL	Free Interior, Keyed Lever UL	\$62.00		\$62.00			\$65.00	\$65.00	\$62.00	20
	413DL SMT	Free Interior, Keyed Lever UL	\$67.00		\$67.00			\$70.00	\$70.00	\$67.00	20
	420DL	Hall/Closet UL	\$41.00		\$41.00	\$44.00	\$44.00	\$44.00	\$44.00	\$41.00	20
	430DL	Bed/Bath UL	\$44.00		\$44.00			\$47.00	\$47.00	\$44.00	20
	462DL	Vestibule Keyed Lever	\$56.00		\$56.00			\$59.00	\$59.00	\$56.00	20
	462DL SMT	Vestibule Keyed Lever	\$61.00		\$61.00			\$64.00	\$64.00	\$61.00	20
	488DL	Half Dummy	\$17.50		\$17.50	\$20.50	\$20.50	\$20.50	\$20.50	\$17.50	20

**Dorian®**

	Model	Function	Finish							Case Qty	
			3	L03	5	11P	15	15A	26		26D
	200DNL	Hall/Closet	\$35.00		\$35.00	\$38.00	\$38.00	\$38.00	\$38.00	\$35.00	20
	300DNL	Bed/Bath	\$38.00		\$38.00	\$41.00	\$41.00	\$41.00	\$41.00	\$38.00	20
	405DNL	Keyed Lever	\$53.00		\$53.00	\$56.00	\$56.00	\$56.00	\$56.00	\$53.00	20
	405DNL SMT	Keyed Lever	\$58.00		\$58.00	\$61.00	\$61.00	\$61.00	\$61.00	\$58.00	20
	406DNL	Free Interior, Keyed Lever	\$56.00		\$56.00	\$59.00	\$59.00	\$59.00	\$59.00	\$56.00	20
	406DNL SMT	Free Interior, Keyed Lever	\$61.00		\$61.00			\$64.00	\$64.00	\$61.00	20
	409DNL	Keyed Lever UL	\$59.00		\$59.00	\$62.00	\$62.00	\$62.00	\$62.00	\$59.00	20
	409DNL SMT	Keyed Lever UL	\$64.00		\$64.00	\$67.00	\$67.00	\$67.00	\$67.00	\$64.00	20
	412DNL	Vestibule Keyed Lever UL	\$62.00		\$62.00			\$65.00	\$65.00	\$62.00	20
	412DNL SMT	Vestibule Keyed Lever UL	\$67.00		\$67.00	\$70.00	\$70.00	\$70.00	\$70.00	\$67.00	20
	413DNL	Free Interior, Keyed Lever UL	\$62.00		\$62.00			\$65.00	\$65.00	\$62.00	20
	413DNL SMT	Free Interior, Keyed Lever UL	\$67.00		\$67.00			\$70.00	\$70.00	\$67.00	20
	420DNL	Hall/Closet UL	\$41.00		\$41.00	\$44.00	\$44.00	\$44.00	\$44.00	\$41.00	20
	430DNL	Bed/Bath UL	\$44.00		\$44.00	\$47.00	\$47.00	\$47.00	\$47.00	\$44.00	20
	462DNL	Vestibule Keyed Lever	\$56.00		\$56.00	\$59.00	\$59.00	\$59.00	\$59.00	\$56.00	20
	462DNL SMT	Vestibule Keyed Lever	\$61.00		\$61.00	\$64.00	\$64.00	\$64.00	\$64.00	\$61.00	20
	488DNL	Half Dummy	\$17.50		\$17.50	\$20.50	\$20.50	\$20.50	\$20.50	\$17.50	20

**Ladera®**

	Model	Function	Finish							Case Qty	
			3	L03	5	11P	15	15A	26		26D
	200LRL	Hall/Closet				\$38.00	\$38.00		\$38.00	\$35.00	20
	300LRL	Bed/Bath				\$41.00	\$41.00		\$41.00	\$38.00	20
	405LRL	Keyed Lever				\$56.00	\$56.00		\$56.00	\$53.00	20
	405LRL SMT	Keyed Lever				\$61.00	\$61.00		\$61.00	\$58.00	20
	488LRL	Half Dummy				\$20.50	\$20.50		\$20.50	\$17.50	20

**Aliso™**

	Model	Function	Finish							Case	
			3	L03	5	11P	15	15A	26	26D	Qty
	200AO	Hall/Closet	\$23.00			\$26.00	\$26.00		\$26.00		30
	300AO	Bed/Bath	\$26.00			\$29.00	\$29.00		\$29.00		30
	400AO SMT	Entry	\$37.00			\$40.00	\$40.00		\$40.00		30
	488AO	Half Dummy	\$11.50			\$14.50	\$14.50		\$14.50		20

**Cove™**

	Model	Function	Finish							Case	
			3	L03	5	11P	15	15A	26	26D	Qty
	200CV	Hall/Closet				\$26.00	\$26.00		\$26.00	\$23.00	30
	300CV	Bed/Bath				\$29.00	\$29.00		\$29.00	\$26.00	30
	400CV	Entry				\$35.00	\$35.00		\$35.00	\$32.00	30
	400CV SMT	Entry				\$40.00	\$40.00		\$40.00	\$37.00	30
	488CV	Half Dummy				\$14.50	\$14.50		\$14.50	\$11.50	20

**Polo®**

	Model	Function	Finish							Case	
			3	L03	5	11P	15	15A	26	26D	Qty
	200P	Hall/Closet	\$20.00		\$20.00	\$23.00	\$23.00	\$23.00	\$23.00	\$20.00	30
	300P	Bed/Bath	\$23.00		\$23.00	\$26.00	\$26.00	\$26.00	\$26.00	\$23.00	30
	400P	Entry	\$29.00		\$29.00	\$32.00	\$32.00	\$32.00	\$32.00	\$29.00	30
	400P SMT	Entry	\$34.00		\$34.00	\$37.00	\$37.00	\$37.00	\$37.00	\$34.00	30
	401P	Entry, Free Interior	\$32.00		\$32.00	\$35.00	\$35.00			\$32.00	30
	401P SMT	Entry, Free Interior	\$37.00		\$37.00	\$40.00	\$40.00			\$37.00	30
	450P	Vestible	\$32.00		\$32.00					\$32.00	30
	450P SMT	Vestible	\$37.00		\$37.00					\$37.00	30
	488P	Half Dummy	\$10.00		\$10.00	\$13.00	\$13.00	\$13.00	\$13.00	\$10.00	20

**Tylo®**

	Model	Function	Finish							Case	
			3	L03	5	11P	15	15A	26	26D	Qty
	200T	Hall/Closet	\$18.00		\$18.00		\$21.00		\$21.00	\$18.00	30
	300T	Bed/Bath	\$21.00		\$21.00		\$24.00		\$24.00	\$21.00	30
	400T	Entry	\$27.00		\$27.00		\$30.00		\$30.00	\$27.00	30
	400T SMT	Entry	\$32.00		\$32.00		\$35.00		\$35.00	\$32.00	30
	401T	Entry, Free Interior	\$30.00		\$30.00		\$33.00			\$30.00	30
	401T SMT	Entry, Free Interior	\$35.00		\$35.00		\$38.00			\$35.00	30
	488T	Half Dummy	\$9.00		\$9.00		\$12.00		\$12.00	\$9.00	20

**660CRR**



Model	Function	Finish								Case
		3	L03	5	11P	15	15A	26	26D	Qty
660CRR	Single Cylinder SMT				\$46.00	\$46.00		\$46.00	\$43.00	12
665CRR	Double Cylinder SMT				\$56.00	\$56.00		\$56.00	\$53.00	12

**660/665**



Model	Function	Finish								Case
		3	L03	5	11P	15	15A	26	26D	Qty
660	Single Cylinder	\$28.00		\$28.00	\$31.00	\$31.00	\$31.00	\$31.00	\$28.00	12
660 SMT	Single Cylinder SMT	\$33.00		\$33.00	\$36.00	\$36.00	\$36.00	\$36.00	\$33.00	12
665	Double Cylinder	\$36.00		\$36.00	\$39.00	\$39.00	\$39.00	\$39.00	\$36.00	12
665 SMT	Double Cylinder SMT	\$43.00		\$43.00	\$46.00	\$46.00	\$46.00	\$46.00	\$43.00	12

**One-Sided**



Model	Function	Finish								Case
		3	L03	5	11P	15	15A	26	26D	Qty
663CRR	Thumbturn One Side				\$27.00	\$27.00		\$27.00	\$24.00	12
663	Thumbturn One Side	\$14.00		\$14.00	\$17.00	\$17.00	\$17.00	\$17.00	\$14.00	12
667	Thumbturn One Side with Exterior Plate	\$28.00		\$28.00	\$31.00	\$31.00	\$31.00	\$31.00	\$28.00	12
664	Retrofit Kit for 663	\$9.50		\$9.50	\$12.50	\$12.50			\$9.50	12
677	Thumbturn One Side with Exterior Plate UL	\$34.00		\$34.00	\$37.00	\$37.00			\$34.00	12

**Combo Pack Availability**



Model	Function	Finish								Case
		3	L03	5	11P	15	15A	26	26D	Qty
690T	Keyed Entry Tylo Knob with Single Cylinder Deadbolt	\$50.00		\$50.00		\$50.00			\$50.00	6
690T SMT	Keyed Entry Tylo Knob with Single Cylinder Deadbolt	\$59.00		\$59.00		\$59.00			\$59.00	6
690P	Keyed Entry Polo Knob with Single Cylinder Deadbolt	\$51.00				\$51.00				6



**KWIKSET HANDLESETS**

Door Prep	Deadbolt: Crossbore 2-1/8" or 1-1/2". Edge Bore 1". Handle: Crossbore 2-1/8". Edge Bore 1".
Backset	Deadbolt: Adjustable to 2-3/8" or 2-3/4". Handle: Adjustable to 2-3/8" or 2-3/4".
Door Thickness	1-3/4" doors standard. 2-1/4" doors optional. Not designed for use on 1-3/8" doors.
Cylinder	SmartKey Security or traditional 5-Pin, Pin & Tumbler.
Faceplate	1" x 2-1/4". Specify round corner, square corner or drive-in.
Strikes	Deadbolt: 1" x 2-1/4". Specify round corner or square corner. Other options available. Handle: 2-1/4" full lip. Specify round corner or square corner. Other options available.
Bolt	Deadbolt: 1" throw. Handle: 1/2" throw.
Door Handing	Reversible for right or left-hand doors.
ANSI/BHMA	Deadbolt is Grade 3 Certified.
ADA	N/A
UL	Optional UL 1/3 hour fire rating for all functions except 699* & 502

**KWIKSET LEVERS**

Door Prep	Cross Bore 2-1/8". Edge Bore 1".
Backset	Adjustable to 2-3/8" or 2-3/4". UL 2-3/4" standard 2-3/8" optional.
Door Thickness	1-3/8" – 1-3/4" doors standard. 2-1/4" doors optional on 200 and 400 functions only.
Cylinder	SmartKey Security or Pin & Tumbler.
Faceplate	1" x 2-1/4". Specify round corner, square corner or dr
Strikes	1" x 2-1/4" full lip. Specify round corner or square corner. Other options available.
Bolt	1/2" throw.
Door Handing	Delta and Dorian are non-handed. Balboa is reversible for all functions except 488.
ANSI/BHMA	Grade 3 Certified. (all functions except 488)
ADA	Functions 200 and 420 in compliance with the American National Standards Institute (ANSI A117.1) and the Americans with Disabilities Act (ADA).
UL	Meets UL 3 hour fire rating for 409, 412, 413, 420, 430 Optional UL 1/3 hour fire rating for all functions*

**KWIKSET DEADBOLTS**

Door Prep	660, 665: Crossbore 2-1/8". Edge Bore 1". 663: Crossbore 1-5/8". Edge Bore 1". 667: Crossbore 2-1/8" or 1-1/2". Edge Bore 1".
Backset	660, 665, 667: Adjustable latch standard. 663: 2-3/8" standard. 2-3/4" optional.
Door Thickness	660, 663, 665, 667: 1-3/8" – 1-3/4" doors standard.
Cylinder	660, 665: SmartKey Security or Pin & Tumbler.
Faceplate	1" x 2-1/4". Specify round corner, square corner or drive-in.
Strikes	1" x 2-1/4". Specify round corner or square corner. Other options available.
Bolt	1" throw.
Door Handing	Reversible for right or left-hand doors.
ANSI/BHMA	Grade 3 Certified.
ADA	Interior turn pieces are in compliance with the American National Standards Institute (ANSI A117.1) and the Americans with Disabilities Act (ADA).
UL	Meets UL 3 hour fire rating for 677 Optional UL 1/3 hour fire rating for all functions*

**KWIKSET KNOBS**

Door Prep	Cross Bore 2-1/8". Edge Bore 1".
Backset	Adjustable to 2-3/8" or 2-3/4". 5" available as service part
Door Thickness	1-3/8" – 1-3/4" doors standard. 2-1/4" doors optional on 200 and 400 models only.
Cylinder	SmartKey Security or Pin & Tumbler.
Faceplate	1" x 2-1/4". Specify round corner, square corner or drive-in. Also available as drive-in latch.
Strikes	2-1/4" full lip. Specify round corner or square corner. Other options available.
Bolt	1/2" throw.
Door Handing	Reversible for right or left hand doors.
ANSI/BHMA	Grade 3 Certified. (all functions except 488)
ADA	N/A
UL	Optional UL 1/3 hour fire rating for all functions*

\*Optional UL 1/3 hour list price charge is \$2.50.

### KWIKSET HANDLESET

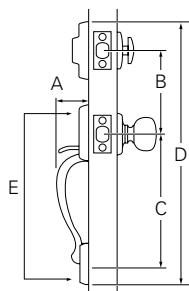

Design	A	B	C	D	E
Amador	2-5/32"	5-1/2"	9-11/16"	17-15/32"	12-14/28"
Belleview™	2-5/32"	5-1/2"	8-13/32"	18-1/16"	12-1/10"
Dakota™	2-5/32"	5-1/2"	8-13/32"	17-3/16"	12-1/10"

### KWIKSET KNOB

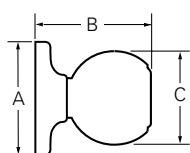

Design	A	B	C
Aliso™	2-5/8"	2-3/4"	2-2/5"
Cove™	2-5/8"	2-1/2"	2-3/16"
Polo®	2-5/8"	2-23/32"	1-7/8"
Tylo®	2-5/8"	2-1/2"	1-7/8"

### KWIKSET LEVER

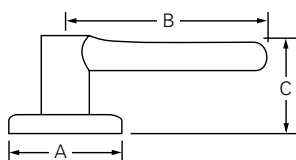

Design	A	B	C	C (Keyed)
Balboa™	2-5/8"	4-7/32"	1-15/16"	2-13/32"
Delta®	2-5/8"	3-5/8"	1-7/8"	2-15/32"
Dorian®	2-5/8"	3-3/4"	2-1/8"	2-11/16"
Ladera®	2-5/8"	4-3/16"	1-7/8"	2-7/16"

### KWIKSET DEADBOLT

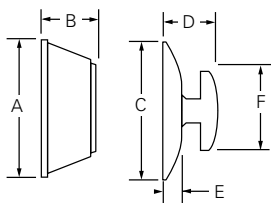

Design	A	B	C	D	E	F
660	2-7/16"	1-1/16"	2-1/2"	27/32"	5/16"	1-3/4"
660CRR	2-7/16"	1-1/16"	2-1/2"	31/32"	1-3/4"	
663			2-1/2"	27/32"	5/16"	1-3/4"
663CRR			2-1/2"	31/32"	1-3/4"	
665	2-7/16"	1-1/16"	2-1/2"	1-1/16"		
665CRR	2-7/16"	1-1/16"	2-7/16"	1-1/16"		
667	2-17/32"	3/8"	2-1/2"	27/32"	5/16"	1-3/4"
677	2-17/32"	3/8"	2-1/2"	27/32"	5/16"	1-3/4"

# kēvo

Touch to Open® Smart Lock

Open your world with the latest Touch-to-Open Kevo smart lock, powered by your smartphone and Bluetooth. Fumbling with your keys is now a thing of the past.



# kēvo CONVERT

Kevo Convert is a smart lock conversion kit. It uses your existing deadbolt and turns it into a smart lock in minutes! No hardwiring needed.



**Kevo Convert on the inside**

Easily replace your current lock's interior hardware only & install in minutes

**Existing lock on the outside**

Your current lock's exterior hardware stays the same. No additional installation required.



Kevo is compatible with:



Nest



Apple® Watch Notifications



Honeywell® Thermostats™ (select models)



Ring™ Video Doorbell



Skybell™ WiFi Doorbell



Android Wear

For a complete compatibility list: [kwikset.com/kevo/compatibility](http://kwikset.com/kevo/compatibility)

Kevo 2nd Gen™ Model	Description	3	L03	5	11P	15	15A	26	26D	Qty
925 KEVO 2 DB	Bluetooth Enabled Deadbolt				\$458.00	\$458.00	\$458.00			1

Kevo Convert™ Model	Description	3	L03	5	11P	15	15A	26	26D	Qty
925 KEVO CONVERT	Smart Lock Conversion Kit				\$298.00	\$298.00				1

Kevo Fob™ Model	Description	3	L03	5	11P	15	15A	26	26D	N/A	Qty
926	Kevo Key Fob									\$54.00	4



# kēvo™

Touch-to-Open® Smart Lock

## Dimensions

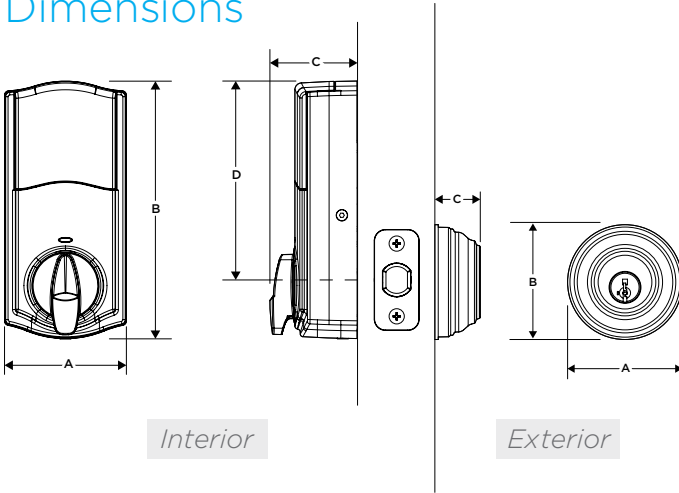

Design	AB		CD	
Kevo™ Interior	2 3/4" (50.8 mm)	5 3/4" (146.05 mm)	2" (44.45 mm)	1 3/16" (30.16 mm)
Kevo™ Exterior	2 3/4" (69.85 mm)	2 3/4" (69.85 mm)	1 5/32" (29.37 mm)	---

# kēvo™

## CONVERT

Smart Lock Conversion Kit

## Dimensions

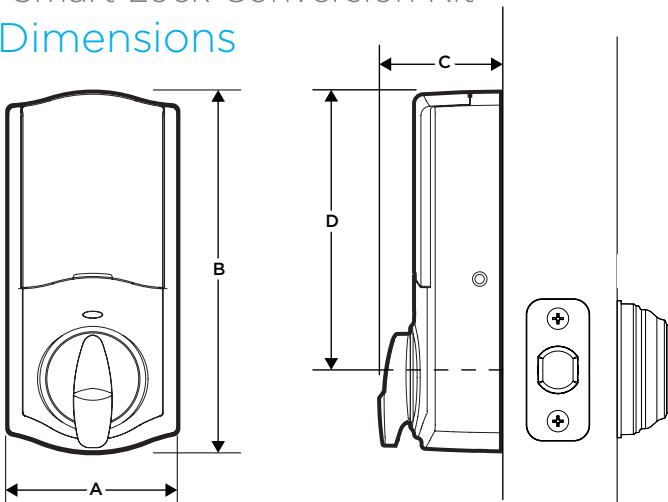

Design	AB		CD	
Kevo™ Convert	2 3/4" (69.85 mm)	5 3/4" (146.05 mm)	2" (50.8 mm)	4 9/16" (115.88 mm)

## System Requirements

- Bluetooth Smart ready with a Bluetooth 4.0 enabled device
- Data connection required to download Kevo mobile app
- Smartphone compatibility: Apple iPhone 4S or higher and Android 5.0 (Lollipop) or higher. Check here for an updated compatibility list: [www.kwikset.com/Kevo](http://www.kwikset.com/Kevo)

## Specifications

<b>Function</b>	Single Cylinder Deadbolt
<b>Door Prep</b>	2 1/8" diameter face hole & 1" diameter latch hole
<b>Backset</b>	Adjustable 2 3/8" or 2 3/4"
<b>Door Thickness</b>	1 3/4" automatic adjustment
<b>Cylinder</b>	SmartKey Security®
<b>Faceplates</b>	1" x 2 1/4" round corner standard
<b>Strikes</b>	Round corner strike 2 3/4" x 1 1/8"
<b>Latch</b>	Round corner adjustable 2 3/8" x 2 3/4"
<b>Bolt</b>	1" throw, steel deadbolt
<b>Door Handing</b>	Reversible
<b>Batteries</b>	4AA Required

## What's In The Box

- Kevo deadbolt
- 2 eKeys
- 4 AA batteries
- 2 standard keys

## System Requirements

- Smartphone compatibility: Apple iPhone 4S or higher and select Android 5.0 (Lollipop) or higher. Requires iOS 8 or higher and Android 5.0 or higher.
- Data connection required to download Kevo mobile app
- Visit [kevosmart.com](http://kevosmart.com) for details
- Download App from



## Specifications

<b>Function</b>	Smart Lock Conversion kit
<b>Backset</b>	Adjustable 2 3/8" or 2 3/4"
<b>Door Thickness</b>	1 3/8" - 1 3/4" automatic adjustment
<b>Door Handing</b>	Reversible
<b>Batteries</b>	4AA Required

## What's In The Box

- Kevo Convert Unit
- Lock Adapters
- Mounting Hardware
- 4 AA Batteries

# Electronic Locks

Kwikset's electronic door locks offer users the convenience of keyless entry, virtually eliminating the need for keys. All of our electronic locks are easy to install and program while complementing any Kwikset knob, lever or handleset.



## Features



- Smart Locks Replace any Deadbolt for Keyless Entry Convenience
- SmartCode™ Lever Ideal for - Small/Home Office, Utility/Storage Room, Interior Garage/Side Door
- Lock Your Door with the Touch of a Button
- Customizable Access Codes for Increased Security
- Back-Lit Keypad for Increased Visibility
- Customizable Automatic Door Locking After 30 Seconds for Peace Of Mind
- Installs In Minutes with Just a Screwdriver - No Hard Wiring Required
- Fits Standard Doors ( 1 3/8" - 2" ) with No Screw Holes Required

## Warranty

- 1 Year Electronic Warranty
- Lifetime Finish & Mechanical Warranty

**Obsidian™**

Model	Description	3	L03	5	11P	15	15A	26	26D	514	Qty
953 OBN	Touchpad Electronic Deadbolt				\$370.00	\$370.00					2

NEW!



**Premis™**

Model	Description	3	L03	5	11P	15	15A	26	26D	514	Qty
919 TRL PREMIS	Touchpad Electronic Deadbolt				\$440.00	\$440.00					2

NEW!



**SmartCode™**

Model	Description	3	L03	5	11P	15	15A	26	26D	514	Qty
915 CNT	Touchpad Electronic Deadbolt				\$370.00	\$370.00		\$370.00			2

NEW!



**SmartCode™**

Model	Description	3	L03	5	11P	15	15A	26	26D	514	Qty
915 TRL	Touchpad Electronic Deadbolt		\$370.00		\$370.00	\$370.00					2

NEW!



**SmartCode™**

Model	Description	3	L03	5	11P	15	15A	26	26D	514	Qty
913 CNT SMT	Touchpad Electronic Deadbolt				\$250.00	\$250.00		\$250.00			2

NEW!



**SmartCode™**



Model	Description	3	L03	5	11P	15	15A	26	26D	514	Qty
913 TRL SMT	Touchpad Electronic Deadbolt		\$250.00		\$250.00	\$250.00					2

**SmartCode™**



Model	Description	3	L03	5	11P	15	15A	26	26D	514	Qty
909 CNT SMT	Touchpad Electronic Deadbolt - Contemporary				\$220.00	\$220.00		\$220.00	\$220.00		2

**SmartCode™**



Model	Description	3	L03	5	11P	15	15A	26	26D	514	Qty
909 SMT	Touchpad Electronic Deadbolt		\$210.00		\$210.00	\$210.00					2

**SmartCode™**



Model	Description	3	L03	5	11P	15	15A	26	26D	514	Qty
911 SMT	Touchpad Electronic Lever		\$250.00		\$250.00	\$250.00					2

**Powerbolt 2®**



Model	Description	3	L03	5	11P	15	15A	26	26D	514	Qty
907 SMT	Touchpad Electronic Deadbolt		\$143.00		\$143.00	\$143.00					2

Control your lock from anywhere on your smart phone, tablet, or internet connected device and never worry about forgetting to lock your door again.

- Remotely lock and unlock your door from anywhere
- Receive notifications of your lock's activity
- Control when others have access to your home
- Arm or disarm your security panel
- Wirelessly communicate to other devices in your home



### Features

- Full 128-Bit Encryption Security
- Motorized locking mechanism enables true remote locking & unlocking
- SmartKey Security - providing superior security against advanced break-in techniques.
- Easy Integration
- Z-Wave Wireless Protocol
- Fits Standard Doors (1 3/8"-2") with No Screw Holes Required
- 4 AA Alkaline Batteries (no hard wiring) - batteries last for approximately 1 year

#### Electronic Locks with Home Connect (Z-Wave)

Item Number	Function	Finish					Case Qty.	Price
		L03	11P	15	26	26D		
<b>SmartCode™ 916 with Home Connect</b>		L03	11P	15	26	26D		
99160-001	SmartCode™ 916 Deadbolt	•					2	\$460.00
99160-002	SmartCode™ 916 Deadbolt			•			2	\$460.00
99160-003	SmartCode™ 916 Deadbolt		•				2	\$460.00

\*Product must be ordered by item number and not description

Item Number	Function	Finish					Case Qty.	Price
		L03	11P	15	26	26D		
<b>SmartCode™ 914 with Home Connect</b>		L03	11P	15	26	26D		
99140-001	SmartCode™ 914 Deadbolt	•					2	\$395.00
99140-002	SmartCode™ 914 Deadbolt			•			2	\$395.00
99140-003	SmartCode™ 914 Deadbolt		•				2	\$395.00

\*Product must be ordered by item number and not description

Item Number	Function	Finish					Case Qty.	Price
		L03	11P	15	26	26D		
<b>SmartCode™ 912 with Home Connect</b>		L03	11P	15	26	26D		
99120-026	SmartCode™ 912 Lever - Tustin	•					2	\$375.00
99120-005	SmartCode™ 912 Lever - Tustin			•			2	\$375.00
99120-006	SmartCode™ 912 Lever - Tustin		•				2	\$375.00

\*Product must be ordered by item number and not description

Item Number	Function	Finish					Case Qty.	Price
		L03	11P	15	26	26D		
<b>SmartCode™ 910 with Home Connect</b>		L03	11P	15	26	26D		
99100-004	SmartCode™ 910 Deadbolt	•					2	\$375.00
99100-005	SmartCode™ 910 Deadbolt			•			2	\$375.00
99100-006	SmartCode™ 910 Deadbolt		•				2	\$375.00

\*Product must be ordered by item number and not description

99100-011	SmartCode™ 910 Deadbolt - CNT			•			2	\$375.00
99100-012	SmartCode™ 910 Deadbolt - CNT				•		2	\$375.00
99100-013	SmartCode™ 910 Deadbolt - CNT					•	2	\$375.00
99100-014	SmartCode™ 910 Deadbolt - CNT		•				2	\$375.00

\*Product must be ordered by item number and not description

Item Number	Function	Finish					Case Qty.	Price
		L03	11P	15	26	26D		
<b>Signature Series Deadbolt with Home Connect</b>		L03	11P	15	26	26D		
99100-061	910 S TRL ZW L03 SMT BP TPR RCALFD SCR	•					2	\$315.00
99100-062	910 S TRL ZW 15 SMT BP TPR RCALFD SCR			•			2	\$315.00
99100-063	910 S TRL ZW 11P SMT BP TPR RCALFD SCR		•				2	\$315.00

\*Product must be ordered by item number and not description

99100-064	910 S CNT ZW 15 SMT BP TPR RCALFD SCR			•			2	\$315.00
99100-065	910 S CNT ZW 11P SMT BP TPR RCALFD SCR		•				2	\$315.00

\*Product must be ordered by item number and not description



**SMARTCODE™ 910, 914, 916**

Door Prep	2-1/8" diameter face hole & 1" diameter latch hole
Backset	Adjustable to 2-3/8" or 2-3/4"
Door	1-3/8" to 2" automatic adjustment
Thickness	
Cylinder	SmartKey Security
Faceplate	1" x 2-1/4". Round corner standard
Strikes	Round corner strike 1-1/8" x 2-3/4"
Bolt	1" throw, steel deadbolt
Door Handing	Reversible
Batteries	4 AA Alkaline
Wireless	Z-Wave wireless technology
Communication	
Operation	908.42 MHz (US)
Range	Typical 100ft line of sight

**SMARTCODE™ 909, 913,  
POWERBOLT 2 DEADBOLT**

Function	Single cylinder deadbolt
Door Prep	2-1/8" diameter face hole & 1" diameter latch hole
Backset	Adjustable to 2-3/8" or 2-3/4"
Door	1-3/8" to 2" automatic adjustment
Thickness	
Cylinder	SmartKey Security
Faceplate	1" x 2-1/4" round corner standard
Strikes	Round corner strike 1-1/8" x 2-3/4"
Bolt	1" throw, steel deadbolt
Door Handing	Reversible
Batteries	4 AA Alkaline

**SMARTCODE™ 911 LEVER**

Door Prep	2-1/8" diameter face hole & 1" diameter latch hole
Backset	Adjustable to 2-3/8" or 2-3/4"
Door	1-3/8" to 2" automatic adjustment
Thickness	
Cylinder	SmartKey Security
Faceplate	1" x 2-1/4". Round corner standard
Strikes	2-1/4" full lip. Round corner
Bolt	1/2" throw
Door Handing	Reversible
Batteries	4 AA Alkaline

**SMARTCODE™ 912 LEVER**

Door Prep	2-1/8" diameter face hole & 1" diameter latch hole
Backset	Adjustable to 2-3/8" or 2-3/4"
Door	1-3/8" to 2" automatic adjustment
Thickness	
Cylinder	SmartKey Security
Faceplate	1" x 2-1/4". Round corner standard
Strikes	2-1/4" full lip. Round corner
Bolt	1/2" throw
Door Handing	Reversible
Batteries	4 AA Alkaline
Wireless	Z-Wave wireless technology
Communication	
Operation	908.42 MHz (US)
Range	Typical 100ft line of sight

**SIGNATURE SERIES DEADBOLT W/ HOME CONNECT**

Door Prep	2-1/8" diameter face hole & 1" diameter latch hole
Backset	Adjustable to 2-3/8" or 2-3/4"
Door	1-3/8" to 2" automatic adjustment
Thickness	
Cylinder	SmartKey Security
Faceplate	1" x 2-1/4". Round corner standard
Strikes	Round corner strike, 1-1/8" x 2-3/4"
Bolt	1" throw, steel deadbolt
Door Handing	Reversible
Batteries	4 AA Alkaline
Wireless	Z-Wave wireless technology
Communication	
Operation	908.42 MHz (US)
Range	Typical 100ft line of sight

**OBSDIAN 953**

Function	Single cylinder deadbolt
Door Prep	1-1/2" & 2-1/8" diameter face hole & 1" diameter latch hole
Backset	Adjustable to 2-3/8" or 2-3/4"
Door	1-3/8" to 2"
Thickness	
Faceplates	1" x 2-1/4" round corner standard
Strikes	Round corner
Latch	Round corner adjustable 2-3/8" or 2-3/4"
Bolt	1" throw, steel deadbolt
Door Handing	Reversible
Batteries	6V (4 AA alkaline batteries required)

**SMARTCODE™ 915 / 916 & PREMIS™**

Function	Single cylinder deadbolt
Door Prep	2-1/8" diameter face hole & 1" diameter latch hole
Backset	Adjustable to 2-3/8" or 2-3/4"
Door	1-3/8" to 2-1/8" automatic adjustment
Thickness	
Cylinder	SmartKey Security
Faceplates	1" x 2-1/4" round corner standard
Strikes	Round corner, 4 hole strike, 2-3/4" x 1-1/8"
Latch	Round corner adjustable 2-3/8" or 2-3/4"
Bolt	1" throw, steel deadbolt
Door Handing	Reversible
Batteries	4 AA Required

**OBSDIAN™**

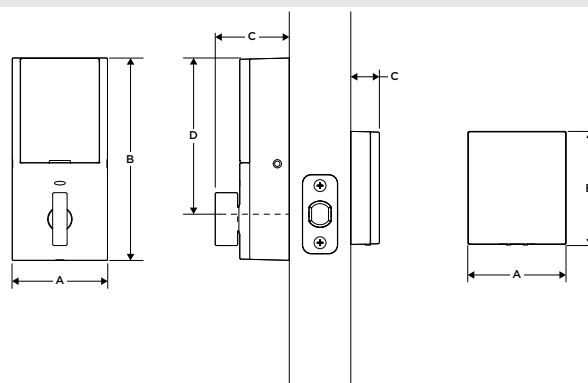

**SMARTCODE™ 915 / 916 & PREMIS™**

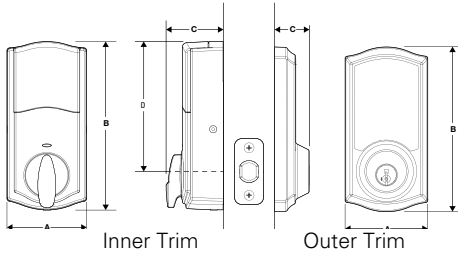

Design	A	B	C	D
Outer Trim	2-13/16"	5-3/8"	1-3/16"	
Inner Trim	2-3/4"	5-3/4"	1-15/16"	4-9/16"

**SMARTCODE™ 911 / 912**

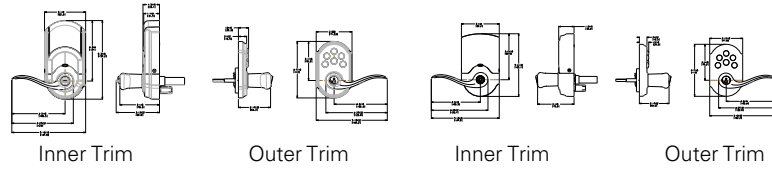

Design	A	B	C
Outer Trim	2-13/16"	4-7/16"	2-11/16"
Inner Trim	3-1/4"	5-3/8"	3-13/32"

**SMARTCODE™ 914**

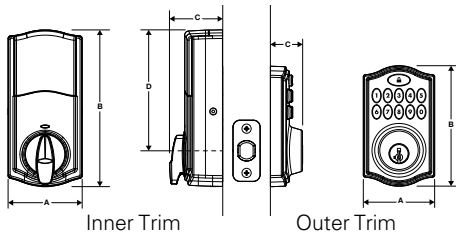

Design	A	B	C	D
Outer Trim	2-5/8"	4-7/16"	1-3/16"	
Inner Trim	2-3/4"	5-3/4"	2"	4-7/16"

**SMARTCODE™ 909 / 910 CONTEMPORARY**

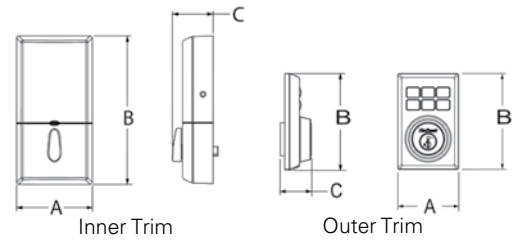

Design	A	B	C
Outer Trim	2-23/32"	4-1/4"	1-3/16"
Inner Trim	3-9/32"	6-13/32"	1-3/4"

**NOTE:** Lifetime Finish and Mechanical Warranty. One Year Electronic Warranty.

**SMARTCODE™ 913 CONTEMPORARY**

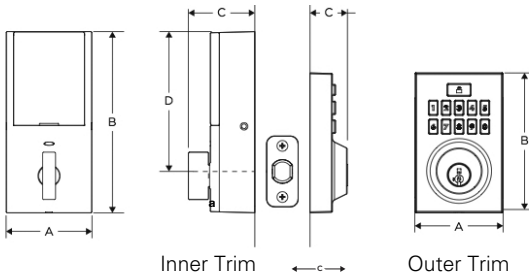

Design	A	B	C	D
Outer Trim	2-25/32"	4-7/16"	1-3/16"	
Inner Trim	2-11/16"	5-3/4"	2-3/32"	4-9/16"

**SMARTCODE™ 909 / 910**

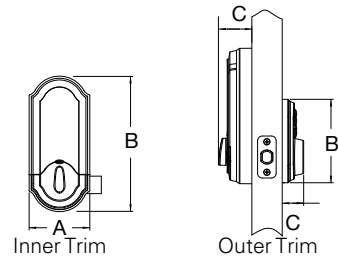

Design	A	B	C
Outer Trim	2-13/16"	4-7/16"	1-3/16"
Inner Trim	3-1/4"	7-1/4"	1-3/4"

**SMARTCODE™ 913**

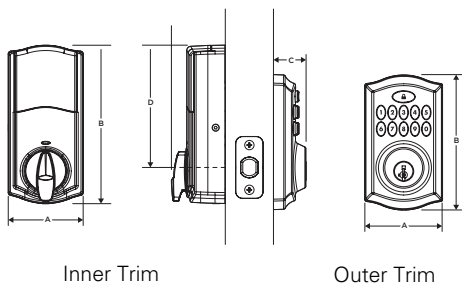

Design	A	B	C	D
Outer Trim	2-7/8"	5"	1-3/16"	
Inner Trim	2-3/4"	5-3/4"	2	4-7/16"

**SMARTCODE™ 910 ROUND**

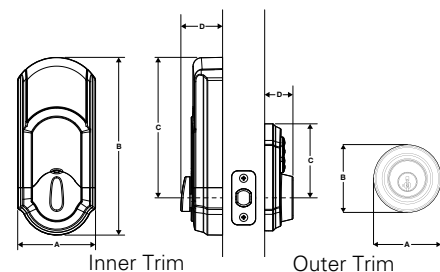

Design	A	B	C	D
Outer Trim	2-29/32"	2-11/16"		
Inner Trim	3-9/32"	6-13/32"	1-3/4"	

**Interconnect**



Model	Function	Style		Deadbolt				Finish			
				3	L03	5	11P	15	15A	26	26D
506	Entry	Hancock	780	\$221.00	\$226.00	\$221.00	\$226.00	\$226.00	\$226.00	\$226.00	\$221.00
		Commonwealth	780	\$221.00	\$226.00		\$226.00	\$226.00			
		Tustin	780	\$221.00		\$221.00	\$226.00	\$226.00	\$226.00	\$226.00	\$221.00
		Kingston	780	\$221.00		\$221.00					\$221.00
506 SMT	Entry	Hancock	780	\$221.00	\$226.00	\$221.00	\$226.00	\$226.00	\$226.00	\$226.00	\$221.00
		Commonwealth	780	\$221.00	\$226.00		\$226.00	\$226.00			
		Tustin	780	\$221.00		\$221.00	\$226.00	\$226.00	\$226.00	\$226.00	\$221.00
		Kingston	780	\$221.00		\$221.00					\$221.00
508	Passage	Hancock	780	\$205.00	\$210.00	\$205.00	\$210.00	\$210.00	\$210.00	\$210.00	\$205.00
		Commonwealth	780	\$205.00	\$210.00		\$210.00	\$210.00			
		Tustin	780	\$205.00		\$205.00	\$210.00	\$210.00	\$210.00	\$210.00	\$205.00
		Kingston	780	\$205.00		\$205.00	\$210.00	\$210.00			\$205.00
508 SMT	Passage	Hancock	780	\$205.00	\$210.00	\$205.00	\$210.00	\$210.00	\$210.00	\$210.00	\$205.00
		Commonwealth	780	\$205.00	\$210.00		\$210.00	\$210.00			
		Tustin	780	\$205.00		\$205.00	\$210.00	\$210.00	\$210.00	\$210.00	\$205.00
		Kingston	780	\$205.00		\$205.00	\$210.00	\$210.00			\$205.00

- 506 & 505 interconnect functions utilize turn button locking
- Split finish options available

**Interconnect Levers - 660 Deadbolt Options**

Model	Function	Style	3	L03	5	11P	15	15A	26	26D
505	Entry	Kingston	\$205.00		\$205.00					\$205.00

**Interconnect Levers - Handleset Interior Pack Options**

Model	Function	Style	3	L03	5	11P	15	15A	26	26D
502	Passage	Tustin				\$135.00	\$135.00			

**Interconnect Key Control Deadbolt**



Model	Function	Style	Deadbolt	Finish							
				3	L03	5	11P	15	15A	26	26D
508 SMT	Passage	Hancock	816	\$211.00			\$216.00	\$216.00			
		Commonwealth	816			\$216.00	\$216.00				
		Tustin	816	\$211.00			\$216.00	\$216.00			
		Kingston	816	\$211.00			\$216.00	\$216.00			\$211.00

**Contemporary Interconnect**



Model	Function	Style	Deadbolt	Finish									
				3	L03	5	11P	15	15A	26	26D		
506 SMT	Entry	Kingston	780										\$221.00
		Ladera	780				\$226.00	\$226.00			\$226.00	\$221.00	
508	Passage	Kingston	780				\$210.00	\$210.00					\$205.00
		Ladera	780				\$210.00	\$210.00			\$210.00	\$205.00	
508 SMT	Passage	Kingston	780				\$210.00	\$210.00					\$205.00
		Ladera	780				\$210.00	\$210.00			\$210.00	\$205.00	

**Contemporary Interconnect Split Style**

Model	Function	Style (Interior)	Style (Exterior)	Deadbolt	Finish								
					3	L03	5	11P	15	15A	26	26D	
506 SMT	Entry	Ladera Left Hand	Kingston	780									\$221.00
		Ladera Right Hand	Kingston	780									\$221.00
508	Passage	Ladera Left Hand	Kingston	780				\$210.00	\$210.00				\$205.00
		Ladera Right Hand	Kingston	780				\$210.00	\$210.00				\$205.00
508 SMT	Passage	Ladera Left Hand	Kingston	780				\$210.00	\$210.00				\$205.00
		Ladera Right Hand	Kingston	780				\$210.00	\$210.00				\$205.00

**Contemporary Interconnect Interior Pack**

Model	Function	Style	Finish								
			3	L03	5	11P	15	15A	26	26D	
502	Interior Pack	Ladera				\$135.00	\$135.00			\$135.00	\$130.00
502	Interior Pack	Kingston									\$130.00

**Key Control Deadbolt**



Model	Function	Finish								Case
		3	L03	5	11P	15	15A	26	26D	Qty
816 SMT	Key Control Deadbolt	\$63.00		\$71.00	\$71.00	\$71.00			\$71.00	12
817 SMT UL	Key Control Deadbolt UL				\$77.00	\$77.00			\$77.00	12

## GRADE 2 LEVERS



Kingston™	Model	Function	Finish							Case	
			3	L03	5	11P	15	15A	26		26D
	721KNL	Hall/Closet UL	\$47.00			\$52.00	\$52.00			\$47.00	12
	733KNL	Bed/Bath UL	\$50.00			\$55.00	\$55.00			\$50.00	12
	756KNL	Keyed Entry UL	\$74.00			\$79.00	\$79.00			\$74.00	12
	756KNL SMT	Keyed Entry UL	\$74.00			\$79.00	\$79.00			\$74.00	12
	781KNL	Storeroom UL	\$77.50			\$82.50	\$82.50			\$77.50	12
	781KNL SMT	Storeroom UL	\$77.50			\$82.50	\$82.50			\$77.50	12
	788KNL	Half Dummy	\$23.50			\$26.00	\$26.00			\$23.50	20

## GRADE 3 LEVERS



Carson™	Model	Function	Finish							Case	
			3	L03	5	11P	15	15A	26		26D
	407CNL	Hall/Closet UL	\$34.00			\$39.00	\$39.00			\$34.00	12
	408CNL	Bed/Bath UL	\$37.00			\$42.00	\$42.00			\$37.00	12
	438CNL	Keyed Entry UL	\$61.00			\$66.00	\$66.00			\$61.00	12
	438CNL SMT	Keyed Entry UL	\$61.00			\$66.00	\$66.00			\$61.00	12
	439CNL	Storeroom UL	\$64.50			\$69.50	\$69.50			\$64.50	12
	439CNL SMT	Storeroom UL	\$64.50			\$69.50	\$69.50			\$64.50	12
	488CNL	Half Dummy	\$17.00			\$19.50	\$19.50			\$17.00	20



Burbank™	Model	Function	Finish							Case	
			3	L03	5	11P	15	15A	26		26D
	407BBL	Hall/Closet UL	\$34.00			\$39.00	\$39.00		\$39.00		12
	408BBL	Bed/Bath UL	\$37.00			\$42.00	\$42.00		\$42.00		12
	438BBL	Keyed Entry UL	\$61.00			\$66.00	\$66.00		\$66.00		12
	439BBL	Storeroom UL	\$64.50			\$69.50	\$69.50		\$69.50		12
	488BBL	Half Dummy	\$17.00			\$19.50	\$19.50		\$19.50		20



Palmina	Model	Function	Finish							Case	
			3	L03	5	11P	15	15A	26		26D
	407PLL	Hall/Closet UL				\$39.00	\$39.00		\$39.00	\$34.00	12
	408PLL	Bed/Bath UL				\$42.00	\$42.00		\$42.00	\$37.00	12
	438PLL SMT*	Keyed Entry UL				\$66.00	\$66.00		\$66.00	\$61.00	12
	488PLL	Half Dummy				\$19.50	\$19.50		\$19.50	\$17.00	20

\*For 438PLL Function must specify RH or LH when ordering

## INTERCONNECT

<b>Door Prep</b>	Crossbore 2-1/8" Edge Bore 1" 5-1/2 center-to-center only.
<b>Backset</b>	Complete locksets: 2-3/4 UL or 2-3/8 UL
<b>Door Thickness</b>	1-3/8" - 2-1/4"
<b>Cylinder</b>	<ul style="list-style-type: none"> <li>506, 508 - utilize 6-pin or SmartKey on 780 deadbolt.</li> <li>505, 507 - utilize 5-pin on 660 deadbolt.</li> <li>502 - determined by handleset ordered.</li> <li>SmartKey Security or Pin &amp; Tumbler.</li> </ul>
<b>Faceplates</b>	Complete locksets: No Default—must specify faceplate. 1" round corner, 1" square corner, 1-1/8 WFL square. Complete locksets: UL 3028, 3031, (WFL option 3846).
<b>Strikes</b>	Deadbolt Strike: UL 5278, 3223 (WFL 4632 opt.).
<b>Door Handing</b>	<ul style="list-style-type: none"> <li>506, 508, 505, 507 - reversible.</li> <li>502 - specify handing.</li> </ul>
<b>ANSI/BHMA</b>	<ul style="list-style-type: none"> <li>506, 508, 505, 507 - Grade 3 Certified.</li> <li>502 - Determined by handleset ordered.</li> </ul>
<b>ADA</b>	Lever options are in compliance with the American National Standards Institute (ANSI A117.1) and the Americans with Disabilities Act (ADA).
<b>UL</b>	Meets UL 3 hour fire rating for all functions except 502.
<b>Interior Locking</b>	<ul style="list-style-type: none"> <li>Push button (for Kingston &amp; Carson).</li> <li>Turn button (for Interconnect).</li> </ul>

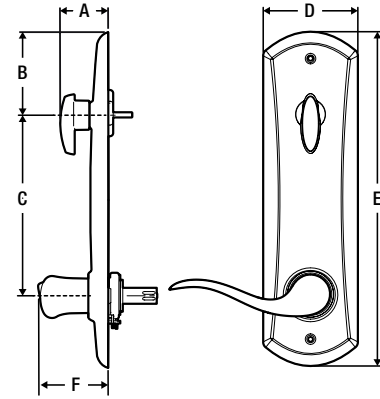

Design	A	B	C	D	E	F
Interconnect	1-7/16"	2-15/32"	5-1/2"	2-53/64"	10"	2-31/32"

## CONTEMPORARY INTERCONNECT

<b>Door Prep</b>	2-1/8" diameter face hole & 1" diameter latch hole.
<b>Backset</b>	Adjustable 2-3/8" or 2-3/4".
<b>Door Thickness</b>	1-3/8" - 1-3/4" automatic adjustment.
<b>Cylinder</b>	<ul style="list-style-type: none"> <li>506 and 508 utilize 6-pin or SmartKey Security on 780 deadbolt.</li> <li>505 utilize 5-pin on 660 deadbolt.</li> <li>502 - determined by handleset ordered.</li> </ul>
<b>Faceplates</b>	1" x 2-1/4" round corner standard.
<b>Strikes</b>	Deadbolt Strike: UL 5278, 3223 (WFL 4632 opt.).
<b>Door Handing</b>	<ul style="list-style-type: none"> <li>506, 508, 505, 507 - reversible.</li> <li>502 - specify handing.</li> </ul>
<b>ANSI/BHMA</b>	<ul style="list-style-type: none"> <li>506, 508, 505 - Grade 3 Certified.</li> <li>502 - Determined by handleset ordered.</li> </ul>
<b>ADA</b>	Lever options are in compliance with the American National Standards Institute (ANSI A117.1) and the Americans with Disabilities Act (ADA).
<b>UL</b>	Meets 3 hour fire rating.

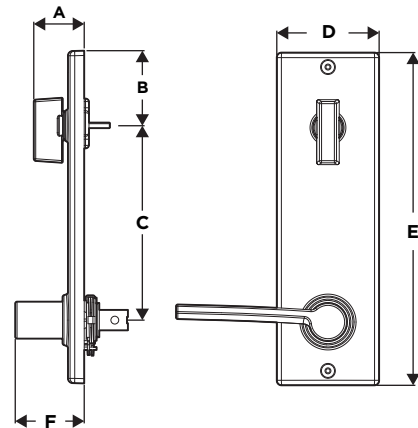

Design	A	B	C	D	E	F
Interconnect	1-13/32"	2-1/16"	5-1/2"	2-27/32"	9-3/16"	1-29/32"

## KEY CONTROL

### SPECIFICATIONS:

<b>Standard Door Prep</b>	Cross Bore 2-1/8". Edge Bore 1" Latch Face 1" x 2-1/4"
<b>Door Thickness</b>	1 3/8" - 1 3/4"
<b>Cylinder</b>	2 SmartKey Security™ cylinders: 1 standard Kwikset for users, 1 unique patented keyway for 1-Key Control
<b>Faceplate</b>	1" x 2-1/4"
<b>Strike</b>	1 1/4" x 3-5/8"
<b>Bolt</b>	1" throw
<b>ANSI/BHMA</b>	A156.5 Grade 2
<b>ADA</b>	Interior turn piece meets 4.13.9 ADA
<b>UL</b>	Meets UL 3 hour fire rating for UL function. UL Ref# R10923

### FUNCTIONS:

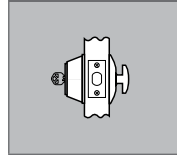

**816 Key Control Deadbolt**  
**817 UL Key Control Deadbolt**  
 Deadbolt operated by key outside and thumb turn inside.

### DIMENSIONS:

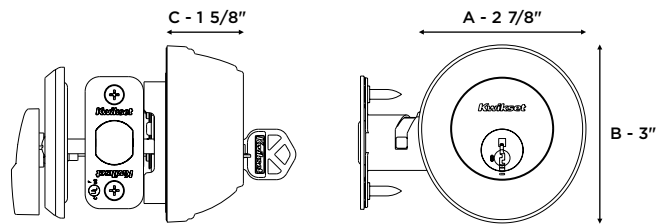

### FINISHES:

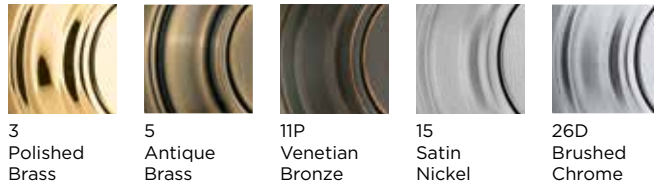

**KINGSTON LEVER**

ANSI/BHMA	Grade 2 Certified
Door Prep	Crossbore 2-1/8" Edge Bore 1"
Backset	Adjustable to 2-3/8" or 2-3/4".
Door Thickness	1-3/8" – 1-3/4" doors standard
Cylinder	SmartKey Security or Pin & Tumbler.
Latch	Adjustable to 2-3/8" or 2-3/4" Specify round corner or square corner, WFL. 2-1/4" full lip UL. Specify round corner or square corner. Other options include 2-3/4"
Strikes	T-Strike and 4-7/8" ASA.
Bolt	1/2" throw.
Door Handing	Reversible for right or left-hand doors.
ADA	Lever options are in compliance with the American National Standards Institute (ANSI A117.1) and the Americans with Disabilities Act (ADA).
UL	Meets UL 3 hour fire rating for all functions
Warranty	Lifetime Mechanical, 5 Year Finish
Interior Locking	Push button (for Kingston & Carson) Turn button (for Interconnect)

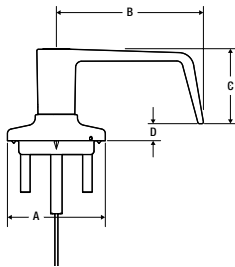

Design	A	B	C	D
Kingston	2.56"	3.84"	1.96"	.44"

**CARSON LEVER**

ANSI/BHMA	Grade 3 Certified
Door Prep	Crossbore 2-1/8" Edge Bore 1"
Backset	Adjustable to 2-3/8" or 2-3/4".
Door Thickness	1-3/8" – 1-3/4" doors standard
Cylinder	SmartKey Security or Pin & Tumbler.
Latch	Adjustable to 2-3/8" or 2-3/4" Specify round corner or square corner, WFL. 2-1/4" full lip UL. Specify round corner or square corner. Other options include 2-3/4"
Strikes	T-Strike and 4-7/8" ASA.
Bolt	1/2" throw.
Door Handing	Reversible for right or left-hand doors.
ADA	Lever options are in compliance with the American National Standards Institute (ANSI A117.1) and the Americans with Disabilities Act (ADA).
UL	Meets UL 3 hour fire rating for all functions
Warranty	Lifetime Mechanical, 5 Year Finish
Interior Locking	Push button (for Kingston & Carson) Turn button (for Interconnect)

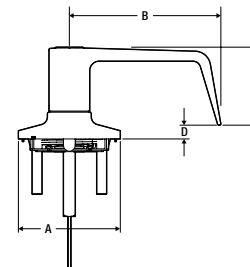

Design	A	B	C	D
Carson	2.56"	3.80"	1.96"	.35"

**BURBANK LEVER**

ANSI/BHMA	Grade 3 Certified
Door Prep	Crossbore 2-1/8" Edge Bore 1"
Backset	Adjustable to 2-3/8" or 2-3/4".
Door Thickness	1-3/8" – 1-3/4" doors standard
Cylinder	Pin & Tumbler.
Latch	RCAL, SCAL, WFAL, NFL
Strikes	ASA-1 t-strike, Full Lip SCS UL, Full Lip 1/4" RCS UL, T Strike
Bolt	1/2" throw.
Door Handing	Reversible for right or left-hand doors.
ADA	Lever options are in compliance with the American National Standards Institute (ANSI A117.1) and the Americans with Disabilities Act (ADA).
UL	Meets UL 3 hour fire rating for all functions
Warranty	Lifetime Mechanical, 5 Year Finish

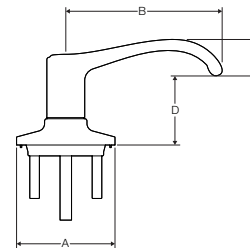

Design	A	B	C	D
Burbank	2.6"	4.07"	0.94"	1.79"

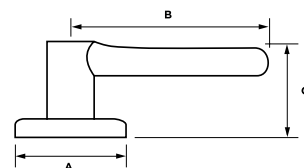

Design	A	B	C	D
Palma	2.56"	3.75"	1.96"	



PRODUCT	Model	Function	Finish								Pkg	Case	
			3	L03	5	11P	15	15A	26	26D			514
<b>Redmond™</b>													<b>Qty</b>
	079RDB	24" Towel Bar				\$51.50	\$40.00		\$28.50			BP	6
	080RDB	Towel Ring				\$34.50	\$25.00		\$17.00			BP	6
	081RDB	Tissue Holder				\$35.50	\$28.50		\$23.00			BP	6
	082RDB	Robe Hook				\$12.50	\$12.50		\$9.50			BP	6



PRODUCT	Model	Function	Finish								Pkg	Case	
			3	L03	5	11P	15	15A	26	26D			514
<b>Ashfield™</b>													<b>Qty</b>
	0795ADB	24" Double Towel Bar				\$175.00	\$175.00		\$118.00			CP	4
	079ADB	24" Towel Bar				\$94.00	\$94.00		\$63.00			CP	4
	080ADB	Towel Ring				\$67.50	\$67.50		\$44.50			CP	4
	081ADB	Tissue Holder				\$73.00	\$73.00		\$47.00			CP	4
	082ADB	Robe Hook				\$40.00	\$40.00		\$28.50			CP	4



PRODUCT	Model	Function	Finish								Pkg	Case	
			3	L03	5	11P	15	15A	26	26D			514
<b>Avalon™</b>													<b>Qty</b>
	079AVB	24" Towel Bar				\$76.50	\$76.50		\$51.50			CP	4
	080AVB	Towel Ring				\$55.00	\$55.00		\$36.50			CP	4
	081AVB	Tissue Holder				\$60.00	\$60.00		\$39.00			CP	4
	082AVB	Robe Hook				\$33.00	\$33.00		\$24.00			CP	4



**Pocket Door Locks**

Model	Function	Finish								Case Qty	
		3	L03	5	11P	15	15A	26D	32		3x32
334	Passage	\$34.00		\$34.00	\$34.00	\$34.00	\$34.00	\$34.00	\$34.00	\$34.00	12



Model	Function	Finish								Case Qty	
		3	L03	5	11P	15	15A	26D	32		3x32
335	Privacy	\$37.00		\$37.00	\$37.00	\$37.00	\$37.00	\$37.00	\$37.00	\$37.00	12





**SmartKey Padlocks**

Part #	Description	List Price	Case Qty
026SMT STD 1-1/8" SHKL PDL 50MM	SmartKey Security Padlock Standard Shackle	\$24.40	6
026SMT LNG 2" SHKL PDL 50MM	SmartKey Security Padlock Long Shackle Shackle	\$25.50	6

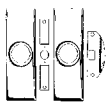
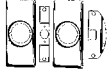

• Keyed alike 6

Trims	Model	Description	Dimensions	Finish				Case	
				3	5	15	26D	Pkg	Qty
	214	Large Modernization Kit	3-1/2" x 10-1/2"	\$71.66				CP	10
	215	Small Modernization Kit	7-1/4" x 3-3/8"	\$50.19				CP	10
	293	Round Rosette	3-13/16"	\$16.28	\$18.43	\$17.17	\$17.17	CP	4

**138 Installation**

Kit	Part #	Description	List Price	Qty per Pack	Master Pk Qty
	91380-001	138 Installation Kit	\$639.30	1	1
	89900-000	Jig with Wood Arm Guide	\$304.70	1	1
	89900-001	Wood Door In-Line Guide Arm	\$67.35	1	1
	89900-002	Metal Door In-Line Guide Arm	\$67.35	1	1

**138 Installation**

Kit Drill Bits	Part #	Description	List Price	Qty per Pack	Master Pk Qty
	89903-001	1" Spade Bit	\$22.50	1	3
	89904-001	2-1/8" Multi Spur Bit	\$99.10	1	3
	89905-001	1-1/2" Multi Spur Bit	\$82.35	1	3
	89906-001	2-1/8" Hole Saw Bit	\$20.75	1	3
	89907-001	Hole Saw Mandrel	\$20.75	1	1
	89908-001	Snap Rings	\$13.25	6	3

**138 Installation**

<b>Kit Mortise Tools Part #</b>	<b>Description</b>	<b>List Price</b>	<b>Qty per Pack</b>	<b>Master Pk Qty</b>
89909-001	Full Lip Strike Mortise Tool	\$37.40	1	3
89910-001	Full Lip Round Corner Strike Blades	\$11.20	3	3
89911-001	Full Lip Square Corner Strike Blades	\$11.20	3	3
89912-001	Latch Mortise Tool	\$39.40	1	3
89913-001	Latch Round Corner Blades	\$13.25	3	3
89914-001	Latch Square Corner Blades	\$13.25	3	3
89915-001	Strike Mortise Tool	\$41.15	1	1
89916-001	Strike Square Corner Blades	\$15.25	3	3
89917-001	Strike Round Corner Blades	\$15.25	3	3

**138 Installation****Kit Miscellaneous**

<b>Parts</b>	<b>Part #</b>	<b>Description</b>	<b>List Price</b>	<b>Qty per Pack</b>	<b>Master Pk Qty</b>
	89918-001	Quick Bit Changer	\$26.35	1	1
	89919-001	Strike Locator	\$6.00	1	1
	89920-001	Strike Locator Tip	\$8.05	3	1
	89921-001	Kit Box	\$33.65	1	1
	89922-001	Jig Bushing	\$25.85	3	1
	89923-001	1-1/2" Adapter Ring	\$11.85	1	1
	89924-001	663 Boring Depth Stop	\$3.85	1	1
	89925-001	Boring Template	\$3.45	1	1
	89926-001	1/8" Hex Wrench	\$1.05	1	1

**Wood Door**



<b>Installation Kit Part #</b>	<b>Description</b>	<b>List Price</b>	<b>Qty per Pack</b>	<b>Master Pk Qty</b>
91300-001	130WD Wood Door Installation Kit	\$32.90	1	3

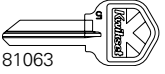
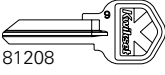
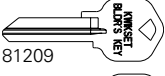
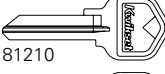
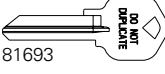
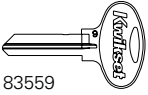
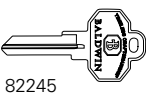

**KEYS & KEY  
BLANKS**

	Model	Function	Qty.	List Price	
<b>Kwikset Key Blanks</b>  81063  81208  81209  81210  81693	81063-009	K Bow, Nickel Plated, 5 Pin	50	\$1.50/E	
	81208-001	K Bow, Nickel Plated, 6 Pin	50	\$1.50/E	
	81209-001	Solid Bow Builders Key - Brass Color	50	\$1.50/E	
	81210-001	Solid Bow Masters Key	50	\$1.50/E	
	81693-001	Do Not Duplicate Key	50	\$1.50/E	
	83559-008	Large Bow, Builder Key, 6 Pin	50	\$1.50/E	
	81695-001	Large Bow, Builder Key, 5 Pin	50	\$1.50/E	
	82245-001	Baldwin K-Key	50	\$2.10/E	
	83559				
	82245				

**Control Key Blanks (Rekeying Tools)**

 	87615-001	Kwikset 6-Pin Knobs and Deadbolts	50	\$1.50/E
	88122-001	Kwikset 6-Pin Knobs and Deadbolts, MK	50	\$1.50/E
	88485-005	Kwikset Knobs and Deadbolts, Schlage® C	12	\$1.50/E
	81804-001	Kwikset Key-In Lever, Standard "TC"	50	\$1.50/E
	89991-001	Kwikset, Schlage® C	50	\$1.50/E

**Emergency Key**

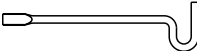
	81087-001	For All Privacy Function Locksets	100	\$0.42/E
---	-----------	-----------------------------------	-----	----------

**Depth Key**

88596-001	Depth Key Ring (Order in full pack quantities only)	5	\$8.10/E
-----------	---	---	----------

**Extra Cut Keys  
KWIKSET 6 Pin**

	Random Cut	*Specify Cut		
	81208-002	90009-074	Regular Key	\$2.95
	81389-001		Set of 2 Keys/ Ringed	\$4.60
	81211-001		Set of 2 Keys w/ Control Key	\$4.60
	81210-002	90009-066	Master Key	\$3.85
	81209-002	90009-069	Builder Key - Brass Color	\$2.95
		90009-082	Control Key	\$1.50

**Extra Cut Keys  
KWIKSET 5 Pin**

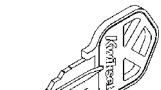
	Random Cut	*Specify Cut		
	81063-005		Regular Key	\$1.90
	81057-007		Set of 8 Keys/Ringed	\$18.40
	81057-002		Set of 2 Keys/ Ringed	\$4.60
	85991-001	90009-003	Master Key	\$3.20
	82205-001	90009-004	Builder Key	\$2.70

**\*NOTE:** Must specify desired key cut when placing order.

**KEYING CHARGES**

<b>KEYING CHARGES &amp; SUPPLIES</b>	<b>Model</b>	<b>Function</b>	<b>Qty.</b>	<b>List Price</b>
<b>Competitive Keying Program - Replacement Parts</b>	8486-75	780/785 Deadbolt, Schlage® keyway less cylinder cover (3, 26)	6	\$14.05/E
	8486-76	780/785 Deadbolt, Weiser keyway less cylinder cover (3, 26)	6	\$14.05/E
	8497-75	Kwikset Signature Series Knob, Schlage® keyway less cylinder cover (3, 26)	6	\$14.05/E
	8497-76	Kwikset Signature Series Knob, Weiser keyway less cylinder cover (3, 26)	6	\$14.05/E
	81354	Kwikset Signature Series Commonwealth Lever, Weiser cylinder (3, 26D)	6	\$20.00/E
	81355	Kwikset Signature Series Commonwealth Lever, Schlage® cylinder (3, 26D)	6	\$20.00/E
	81326	980/985 Deadbolt double cylinder cover - interior (15, 15A, 26, 26D, 3, 5, L03,11P)	12	\$1.15/E
	81327	780/785 Deadbolt single cylinder cover - exterior (15, 15A, 26, 26D, 3, 5, L03,11P)	12	\$1.15/E
	81328	780/785 Deadbolt double cylinder cover - interior (3, 5, 11P)	12	\$1.15/E
	87748-001	Knob plug - Kwikset 6 pin brass finish	20	\$1.70/E
	87807-001	Deadbolt plug - Kwikset Signature Series 6-pin brass finish	20	\$1.70/E
	87807-002	Deadbolt plug - Kwikset Signature Series 6-pin nickel finish	20	\$1.70/E
	88485-005	Rekeying Tool - Schlage®	12	\$1.15/E

## NOTES:

Order in full pack quantities only. Must specify finish in order.

Competitive keying program not compatible with SmartKey product.

**Keying Kits**

92360-001	236 Builder Pin Kit - small	1	\$141.30
92720-001	272 Pin Kit	1	\$249.65

**Specialty  
Keying  
Charges**

Master Keying	MK	\$2.68
Builder Keying (Protecto)	PK	\$2.68
Grand Master Keying	GMK	\$7.51
Builder Master Keying	PMK	\$4.62
Cross Keying / Maison Keying	MAIS	\$5.57
Sequential Construction Master Keying	SEQ	\$9.14

**KEYING CHARGES**



<b>KEYING CHARGES &amp; SUPPLIES</b>	<b>Model</b>	<b>Function</b>	<b>Bottom Pin Size</b>	<b>Qty.</b>	<b>List Price</b>
Competitive Replacement Pins	88550-023		0.156	50	\$0.15/E
	88550-024		0.165	50	\$0.15/E
	88550-025		0.168	50	\$0.15/E
	88550-026		0.172	50	\$0.15/E
	88550-027		0.180	50	\$0.15/E
	88550-028		0.187	50	\$0.15/E
	88550-029		0.195	50	\$0.15/E
	88550-030		0.204	50	\$0.15/E
	88550-031		0.210	50	\$0.15/E
	88550-032		0.218	50	\$0.15/E
	88550-033		0.220	50	\$0.15/E
	88550-034		0.225	50	\$0.15/E
	88550-035		0.234	50	\$0.15/E
	88550-036		0.240	50	\$0.15/E
	88550-037		0.250	50	\$0.15/E
	88550-038		0.255	50	\$0.15/E
	88550-039		0.258	50	\$0.15/E
	88550-040		0.265	50	\$0.15/E
	88550-041		0.270	50	\$0.15/E
	88550-042		0.276	50	\$0.15/E
88550-043		0.287	50	\$0.15/E	
88550-044		0.294	50	\$0.15/E	
88550-045		0.300	50	\$0.15/E	

NOTE: Competitive replacement pins are not compatible with SmartKey product.

**Kwikset  
Keying Parts**

80049-001	Key Gauge			1	\$6.90/E
80152-001	Plug Follower			1	\$7.40/E
80369-001	PK Anti-Pick Top Pin .160"			100	\$0.35/E
80370-001	Regular Anti-Pick Top Pin .180"			100	\$0.35/E
80371-001	Low Profile Deadbolt Spring Cover			10	\$1.15/E
81467-003	Cylinder Removal Tool			1	\$1.80/E
81777-001	Tumbler Spring			100	\$0.15/E
81858-001	Regular Top Pin .180"			100	\$0.15/E
82208-001	PK Balls			100	\$0.15/E
83100-001	#1 Bottom Pin .172"			100	\$0.15/E
83101-001	#2 Bottom Pin .195"			100	\$0.15/E
83103-001	#3 Bottom Pin .218"			100	\$0.15/E
83105-001	#4 Bottom Pin .241"			100	\$0.15/E
83106-001	#5 Bottom Pin .264"			100	\$0.15/E
83107-001	#6 Bottom Pin .287"			100	\$0.15/E
83108-001	#1 Master Pin .023"			100	\$0.15/E
83110-001	#2 Master Pin .046"			100	\$0.15/E
83112-001	#3 Master Pin .069"			100	\$0.15/E
83113-001	#4 Master Pin .092"			100	\$0.15/E
83114-001	#5 Master Pin .115"			100	\$0.15/E
83117-001	PK Top Pin .160"			100	\$0.15/E
83125-001	#6 Master Pin .138"			100	\$0.15/E
83561-001	Spring Cover (6-Pin)			50	\$1.05/E
84345-001	Knob Plug Retainer			100	\$0.15/E
84215-001	Deadlock Plug Retainer			100	\$0.15/E
85757-001	Spring Cover (5-Pin)			50	\$1.05/E
87619-001	Knob Control Lug (Locking Bar)			100	\$0.35/E
87632-001	Spring			100	\$0.55/E
87809-001	Deadlock Control Lug (Locking Bar)			100	\$0.65/E

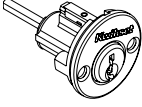
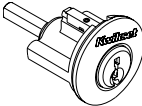
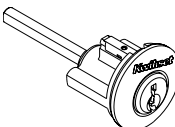
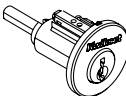
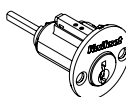
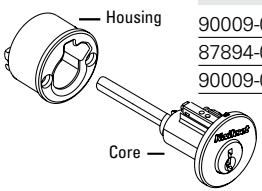
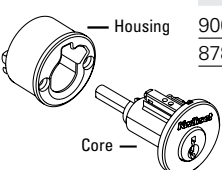
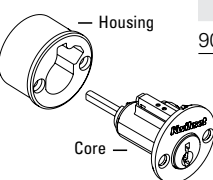
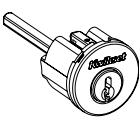
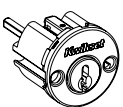
**DEADBOLT  
CYLINDERS**

	Model	Function	List Price
	90009-016	2776 - 665 Interior (5 PIN)	\$14.50
	90009-017	2777 - 665 Exterior (5 PIN)	\$14.50
	90009-041	15843 - 660 Exterior (5 PIN)	\$14.50
	90009-045	785 Exterior without Housing (6 PIN) NOTE: Must specify finish when ordering cylinders	\$16.40
	90009-046	785 Interior without Housing (6 PIN)	\$16.40
	90009-010	87765 - 780 with Housing, Complete Assembly	\$21.10
	87894-001	07894-01 Housing Only, Outside	\$4.75
	90009-044	8325 - 780 Core without Housing	\$16.40
	90009-019	7766 - 785 Exterior with Housing, Complete Assembly	\$21.10
	87894-001	07894-01 Housing Only, Outside	\$4.75
	90009-020	7767 - 785 Interior with Housing, Complete Assembly	\$21.10
	90009-065	13443 980 CYL G1 (6 PIN)	\$42.85
	81227	13423 CVR BDY EXT G1	\$1.15
	90009-078	13448 985 CYL Interior (6 PIN)	\$43.85
	90009-079	13450 985 CYL Exterior (6 PIN)	\$42.85

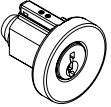
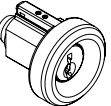
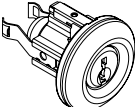
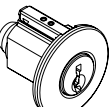
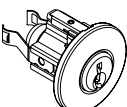

**KNOB  
CYLINDERS**

	Model	Function	List Price
	90009-011	7750A - Abbey (6 PIN)	\$13.25
	90009-012	13754 - Circa (6 PIN)	\$13.25
	90009-042	15860 - Polo (5 PIN)	\$17.80
	90009-043	13752 - Hancock (6 PIN)	\$13.25
	90009-013	1850 - All Other Kwikset & Kwikset Signature Knobs	\$17.80

**LEVER  
CYLINDERS**

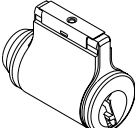
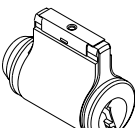
	Model	Function	List Price
	90009-077	24042 - 5-pin P&T cylinder	\$15.10
	90009-076	21664 Kwikset Signatures Lever Cylinder (6 PIN)	\$15.10

**LIGHT COMMERCIAL  
LEVER CYLINDERS**

Model	Function	Finish									List Price
		3	LO3	5	15	15A	26	26D	690/11P	514	
83525	14831 Light Commercial Grade 2 P&T Entry Cylinder	•			•			•	•		\$13.10
83011	14845 Light Commercial Grade 3 P&T Entry Cylinder	•			•			•	•		\$13.10
83526	19496 Light Commercial Grade 2 P&T Storeroom Cylinder	•			•			•	•		\$13.10
83528	19497 Light Commercial Grade 3 P&T Storeroom Cylinder	•			•			•	•		\$13.10

**SMARTKEY  
SECURITY  
CYLINDERS**

Model	Function	Finish										List Price
		3	LO3	5	15	15A	26	26D	690/11P	514	NA	
83279	SMT Knob/Lever Cylinder Only	Gold			Silver				Bronze	Black		\$19.50
83373	SMT Deadbolt Cylinder Only (SGL CYL)	Gold			Silver				Bronze	Black		\$19.50
83025	SMT Deadbolt Cylinder Only for 258 Model	Gold			Silver					Black		\$19.50
83280	SMT CN, C, H, T, CV Cylinder with Housing	•		•	•	•	•	•	•	•		\$19.50
83320	SMT CA, A with Housing	•	•	•	•	•	•	•	•			\$21.75
83281	SMT SGL CYL DB with Housing 780/980/993	•	•	•	•	•	•	•	•			\$43.40
83343	SMT SGL CYL DB with Housing 660	•		•	•	•	•	•	•			\$20.85
83344	SMT DBL CYL DB with Housing 665 Interior & Exterior	•		•	•	•	•	•	•			\$41.70

**SMARTKEY SECURITY  
RE-KEY KITS**

Model	Function	Finish										List Price
		3	LO3	5	15	15A	26	26D	690/11P	514	NA	
83262	Carded CP Re-key Kit (4 silver/2 brass)										•	\$14.40
83335	4 cut keys with re-key tool										•	\$5.10
83336	6 cut keys with re-key tool										•	\$5.70

**SMARTKEY SECURITY  
CONVERSION  
KITS**

Model	Function	Finish										List Price
		3	LO3	5	15	15A	26	26D	690/11P	514	NA	
83325	Abbey & Circa	•	•	•	•	•	•	•	•			\$25.40
83328	Cameron, Hancock, Tylo & Cove	•	•	•	•	•	•	•	•	•		\$25.40
83377	Polo	•		•	•	•	•	•	•			\$25.40
83326	780/800/980	•	•	•	•	•	•	•	•	•		\$45.75
83327	785	•	•	•	•	•	•	•	•	•		\$63.55
83340	801/985		•	•	•	•	•	•	•	•		\$63.55

**RE-KEYING  
TOOLS**

Model	Function	Finish										List Price
		3	LO3	5	15	15A	26	26D	690/11P	514	NA	
83282	Steel Learn Tool										•	\$0.90
83283	Red Plastic KW Learn Tool										•	\$2.90
83576	Learn Tool, T shape										•	\$3.50
83260	Reset Cradle										•	\$43.20
83338	Large Knob/Lever C-Clip (Pack of 50)										•	\$31.75
83337	Large Deadbolt C-Clip (Pack of 50)										•	\$31.75
83374	SmartKey Round Spindle (Knob)										•	\$0.95

**KEY CONTROL DEADBOLT PARTS**

PARTS	Model	Function	Finish					Qty	List Price	
			3	5	11P	15	26D			N/A
	83382	Key Control Deadbolt Key Blanks						•	10	\$3.20
	83383	Key Control Deadbolt Cut Keys						•	10	\$3.85
	83389	Key Control Deadbolt Cylinder Cover	•	•	•	•	•		1	\$2.50
	83390	Key Control Deadbolt Mounting Screws	Gold			Silver			1	\$5.70
	83388	Key Control Deadbolt Torque Blade						•	10	\$1.70
	83386	Key Control Deadbolt Gear Assembly						•	1	\$6.35
	83387	Key Control Deadbolt Screws for Gear Assembly						•	1	\$1.25
	83392	Key Control Deadbolt Tool						•	1	\$3.85
	83393	Key Control Deadbolt Security Mounting Screws	Gold	Gold		Silver	Silver		1	\$3.85
	83394 83395	Key Control Deadbolt Screw Torx Wrench						•	1	\$5.10
	83397	Key Control Deadbolt Thin Door Kit	•			•	•		1	\$12.60

**DEADBOLT ADJUSTABLE**

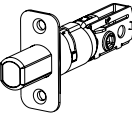
LATCHES	Model	Function	Finish							List Price	
			3	5	15	15A	26/26D	690	514		NA
	81305	660 Series Deadbolt Standard	•	•	•	•	•	•	•	•	\$9.60
	81258	780/782/816/817/980/982 Series Deadbolt Standard UL 3 hour		•		•		•	•		\$24.85
	83347	158/780/816/980 Deadbolt Standard	•	•	•	•	•	•	•		\$15.00
	80391	Tapered Bolt Deadbolt*	•		•			•			\$24.85
	*Replacement Only										

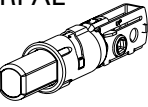
LATCHES	Model	Function	Finish							List Price	
			3	5	15	15A	26/26D	690	514		NA
	81306	660 Series Deadbolt Standard								•	\$9.60
	83371	158/780 /816/980/ Series Deadbolt Standard								•	\$15.00
	80393	Tapered Bolt Deadbolt*	•		•				•		\$24.85
	*Replacement Only										

LATCHES	Model	Function	Finish							List Price	
			3	5	15	15A	26/26D	690	514		NA
	81308	660 Series Deadbolt Standard	•	•	•	•	•	•	•		\$9.60
	84513	780/782 Series Deadbolt Standard UL 3 hour	•	•	•	•	•	•			\$18.00
	81257	816/817/980/982 Series Deadbolt Standard UL 3 hour latch	•		•		•		•		\$24.85
	83370	158/780/816/980 Series Deadbolt Standard	•	•	•	•	•	•	•	•	\$15.00
	80392	Tapered Bolt Deadbolt*	•		•			•			\$24.85
	*Replacement Only										

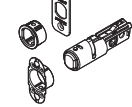
LATCHES	Model	Function	Finish							List Price	
			3	5	15	15A	26/26D	690	514		NA
	83002	4AL 158/780/816/980 Series Deadbolt				•			•	•	\$18.90

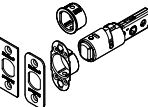
LATCHES	Model	Function	Finish							List Price	
			3	5	15	15A	26/26D	690	514		NA
	83023	6AL 258 Series Deadbolt			•		•		•		\$21.00

**DEADBOLT SPECIALTY**

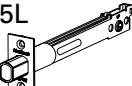
LATCHES	Model	Function	Finish							List Price	
			3	5	15	15A	26/26D	690	514		NA
	82730	5" Kwikset (replacement part only)	•	•			•				\$14.50

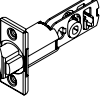
LATCHES	Model	Function	Finish							List Price	
			3	5	15	15A	26/26D	690	514		NA
	83277	Gatelatch Standard	•	•			•				\$23.80

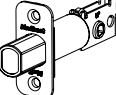
LATCHES	Model	Function	Finish							List Price	
			3	5	15	15A	26/26D	690	514		NA
	82731	2-3/8" Backset	•	•			•		•		\$10.55
	82732	2-3/4" Backset	•	•			•		•		\$10.55

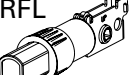
LATCHES	Model	Function	Finish							List Price	
			3	5	15	15A	26/26D	690/	514		NA
	82734	2-3/8" Backset								•	\$10.55
	82735	2-3/4" Backset								•	\$10.55

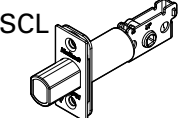
LATCHES	Model	Function	Finish							List Price	
			3	5	15	15A	26/26D	690	514		NA
	82728	2-3/8" Backset	•	•			•		•		\$10.55
	82729	2-3/4" Backset	•	•			•		•		\$10.55

**ADJUSTABLE LATCHES (SQUARE DRIVE)**

BBL, KNL, CNL, HFL, MIL, LSL, MRL, PLL, SYL

6AL	Model	Function	Finish							List Price	
			3/L03	5	15	15A	26/26D	690	514		NA
	83480	6AL Plain Latch HFL, MIL, LSL, MRL, SYL			•		•	•	•		\$12.60
	83000	6AL Deadlatch BBL, KNL, CNL, HFL, MIL, LSL, MRL, PLL, SYL			•		•	•	•		\$13.65

RCAL	Model	Function	Finish							List Price	
			3	5	15	15A	26/26D	690	514		NA
	83521	RCAL Plain Latch UL 3 hour BBL, KNL, CNL, PLL	•		•		•	•			\$10.80
	83518	RCAL Deadlatch UL 3 hour BBL, KNL, CNL, HFL, MIL, LSL, MRL, PLL, SYL	•		•		•	•			\$12.50

WFAL	Model	Function	Finish							List Price	
			3	5	15	15A	26/26D	690	514		NA
	83522	WFAL SCL Plain Latch UL 3 hour BBL, KNL, CNL, PLL	•		•		•	•			\$10.80
	83010	WFAL SCL Deadlatch UL 3 hour BBL, KNL, CNL, HFL, MIL, LSL, MRL, PLL, SYL	•		•		•	•			\$12.50

SCAL	Model	Function	Finish							List Price	
			3	5	15	15A	26/26D	690	514		NA
	83520	SCAL Plain Latch UL 3 hour BBL, KNL, CNL, PLL	•		•		•	•			\$10.80
	83517	SCAL Deadlatch UL 3 hour BBL, KNL, CNL, HFL, MIL, LSL, PLL	•		•		•	•			\$12.50

**ADJUSTABLE LATCHES (HALF-ROUND DRIVE)**

6AL	Model	Function	Finish							List Price	
			3/L03	5	15	15A	26/26D	690	514		NA
	81825	6AL Deadlatch	•	•			•				\$12.50
	81826	6AL Plain Latch	•	•			•				\$10.80

RCAL	Model	Function	Finish							List Price	
			3/L03	5	15	15A	26/26D	690	514		NA
	82246	RCAL Plain Latch	•	•	•	•	•	•	•		\$10.80
	82247	RCAL Deadlatch	•	•	•	•	•	•	•		\$12.50

CORE LATCH	Model	Function	Finish							List Price	
			3/L03	5	15	15A	26/26D	690	514		NA
	81846	Adjustable Latch Core - Deadlatch								•	\$9.15
	81847	Adjustable Latch Core - Plain Latch								•	\$6.45

<p><b>Key:</b>                      5L - 5" Latch                      RCL - Round Corner Latch                      RFL - Round Face Latch (Drive-In Collar attached)                      SCL - Square Corner Latch                      RCAL - Round Corner Adjustable Latch</p>	<p>RFAL - Round Face Adjustable Latch                      SCAL - Square Corner Adjustable Latch                      WFAL - Wide Face Adjustable Latch                      NFAL - Narrow Face Adjustable Latch                      FD - Latch</p>
---	--

**NOTES:**  
 For BBL, KNL, CNL, HFL, MIL and PLL products use square drive plain and deadlatches.  
 All other Kwikset & Kwikset Signature knob and lever products use half-round plain and deadlatches.  
 Plainlatches are used with passage and privacy functions. Deadlatches are used with entry functions.  
 All fronts are 2-1/4" high.  
 For fire rating, UL latches must be used with UL listed locksets and applicable strikes. UL Kwikset and Kwikset Signatures are rated for 3 hours, unless otherwise specified.  
 Optional UL 1/3 hour fire rating is available for all functions (FD).

LATCH PARTS	Model	Function	Finish							List Price		
			3/L03	5	15	15A	26/26D	690	514		NA	
Back Plate	81827	6-Way Back Plate									•	\$0.20

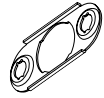

Drive in Collar	81828	6-Way Deadlatch Collar									•	\$1.80
	81829	6-Way Plain Latch Collar									•	\$1.80



Service Kits	81844	6-Way Deadlatch Service Kit	•	•	•	•	•	•	•	•		\$4.55
	81845	6-Way Plain Latch Service Kit	•	•	•	•	•	•	•	•		\$3.55

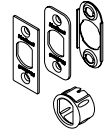

SPECIALTY DEADLATCHES	Model	Function	Finish							List Price
			3/L03	5	15	15A	26/26D	690	514	

SCDL	84292	Square 2-3/4" Backset - UL 3 hour	•	•	•	•	•	•				\$23.80
	84297	Square 2-3/8" Backset - UL 3 hour	•	•	•	•	•	•				\$23.80



WFDL	84255	Square 2-3/4" Backset - UL 3 hour	•	•	•	•	•	•				\$23.80
	84295	Square 2-3/8" Backset - UL 3 hour	•	•	•	•	•	•				\$23.80



5L SCDL	83014	Square 5" Latch (replacement part only)	•	•				•				\$17.25
---------	-------	---	---	---	--	--	--	---	--	--	--	---------

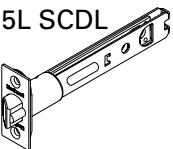

SPECIALTY PLAINLATCHES	Model	Function	Finish							List Price
			3/L03	5	15	15A	26/26D	690	514	

SCPL	84290	Square 2-3/4" Backset - UL 3 hour	•	•	•	•	•	•				\$18.00
	84296	Plain Latch 2-3/8 NF UL 3 Hour	•	•	•	•	•	•				\$18.00

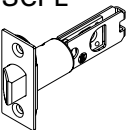



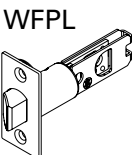

WFPL	84254	Square 2-3/4" Backset - UL 3 hour	•	•	•	•	•	•				\$18.00
	84294	Square 2-3/8" Backset - UL 3 hour	•	•	•	•	•	•				\$18.00

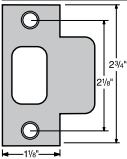
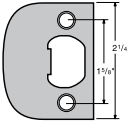
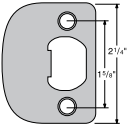
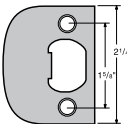
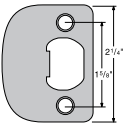
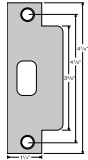

**KEY:**

- 5L - 5" Latch
- DL - Deadlatch
- RC - Round Corner
- SC - Square Corner
- RCL - Round Corner Latch
- RFL - Round Face Latch (Drive In Collar attached)
- SCL - Square Corner Latch
- RCAL - Round Corner Adjustable Latch
- RFAL - Round Face Adjustable Latch
- SCAL - Square Corner Adjustable Latch
- SCDL - Square Corner Deadlatch
- SCPL - Square Corner Plainlatch
- WFAL - Wide Face Adjustable Latch
- WFDL - Wide Face Deadlatch
- WFPL - Wide Face Plainlatch
- FD - Latch

**PLAINLATCH AND DEADLATCH**

Model	Function	Finish								List Price
		3	5	15	15A	26/26D	690	514	NA	
										
80318	Full Round, Adjustable Strike 500 per box	•	•		•					\$1,680.00
80318	Full Round, Adjustable Strike 500 per box			•		•	•			\$2,310.00
										
83028**	T (30 per carton) Standard on 588, 589 and UL Listed Knob and Lever sets. Add \$0.45 elsewhere.	•	•	•	•	•	•	•	•	\$3.20
										
83030**	Full Lip Square Corner Strike, UL UL Option	•	•	•	•	•	•	•	•	\$4.25
										
83031**	Full Lip 1/4" Round Corner Strike, UL UL Option	•	•	•	•	•	•	•	•	\$4.25
										
83437*	Full Lip Square Corner Standard on Non-UL Locksets	•	•	•	•	•	•	•	•	\$3.20
										
83796*	Full Lip 1/4" Round Corner (RCS4)	•	•	•	•	•	•	•	•	\$3.20
										
83846**	ASA-1 (30 per carton) Add \$3.75 to Knob and Lever sets and specify 81967 strike box.	•	•	•	•	•	•	•	•	\$10.20
										
83929	Full Round 1- 3/4"	•	•	•	•	•	•	•	•	\$3.20
										
83536	Round Corner Extended Lip Strike 2-1/4" Qty. 10	•		•		•	•			\$3.20
										
83537	Square Corner Extended Lip Strike 2-1/4" Qty. 10	•		•		•	•			\$3.20
										
83534	Round Corner Adjustable Strike 1.75" to 1.94" Qty. 10	•		•		•	•			\$3.20

NOTES:

\*20-minute fire rating with UL locks and latchbolts.

\*\* 3-hour fire rating with UL Kwikset Signatures and 1.5 hour fire rating with UL Kwikset locks and latchbolts.

DEADBOLT	Model	Function	Finish							List Price	
			3	5	15	15A	26/26D	690/11P	514		NA
	83222**	Deadbolt Strike Standard on 158, 780, 785, 800, 980, 985 Series Deadbolts. Add \$1.45 to 660 Series Deadbolts	•	•	•	•	•	•	•	•	\$3.85
	83223**	Deadbolt Round Corner Strike Standard on 158, 780, 785, 800, 980, 985 Series Deadbolts. Add \$1.45 to 660 Series Deadbolts	•	•	•	•	•	•	•	•	•
	820049**	Square Deadbolt Strike for 258, 553, 818 Series		•	•	•	•	•	•	•	\$3.85
	820050**	Round Deadbolt Strike for 258, 553, 818 Series		•	•	•	•	•	•	•	\$3.85
	84632**	Deadbolt T-Strike (60 per carton)	•	•	•	•	•	•	•		\$3.20
	84638**	Deadbolt, Full Lip	•	•	•	•	•	•	•	•	\$3.20
	85063**	Deadbolt 1" x 2-1/4" Round Corner (RCS4) Standard on 660, 665 Deadbolts.	•	•	•	•	•	•	•		\$3.20
	85072**	Deadbolt 1" x 2-1/4" Standard on 660, 665 Deadbolts.	•	•	•	•	•	•	•		\$3.20
	85278**	Deadbolt, 1-1/8" x 2-3/4" Standard on 782, 784 Deadbolts.		•	•	•	•	•	•		\$3.20
	85279**	Deadbolt, 1-1/8" x 2-3/4" Round Corner Standard on 782, 784 Deadbolts.	•	•	•	•	•	•	•		\$3.20
	85303**	Deadbolt, Full lip Round Corner	•	•	•	•	•	•	•		\$3.20

**NOTES:**

\*20-minute fire rating with UL locks and latchbolts.

\*\* 3-hour fire rating with UL Kwikset Signatures and 1.5 hour fire rating with UL Kwikset locks and latchbolts.



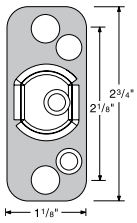

		3	5	15	15A	26/26D	690/11P	514	NA	
81255	Box for 5278/5279 Strike								•	\$3.45

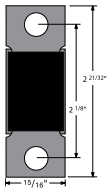

		3	5	15	15A	26/26D	690/11P	514	NA	
81231	Box for 83028 T Strike								•	\$0.95

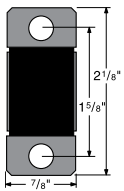

		3	5	15	15A	26/26D	690/11P	514	NA	
83288	Box for Full Lip Strikes Add \$0.45 to locksets using full lip strike.								•	\$1.35

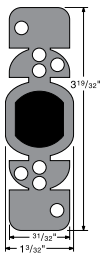

		3	5	15	15A	26/26D	690/11P	514	NA	
81640	Box for all Deadbolt Strikes								•	\$0.95

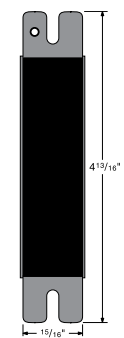

		3	5	15	15A	26/26D	690/11P	514	NA	
81967	Box for 83846 ASA-1 Strike								•	\$4.55

**KNOBS AND LEVERS**

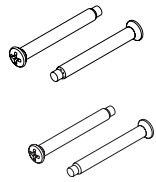

Model	Function	Finish							List Price
		3	5	15/15A	26/26D	690/11P	514	NA	
81834	Signature Lever Screw Pack Styles: A, CA, H, L							•	\$0.95
81835	Signature Lever Screw Pack Styles: ADL, AVL, BRL, CHL, KTL, LL, PML, TNL, VDL / Kwikset Screw Pack Styles: BL, DL, DNL, LRL	•		•	•			•	\$0.55
83369	Signature Lever Screw Pack Styles: C, CN, PE / Kwikset Screw Pack Styles: CV, P, T	•							\$0.55

**SCREW PACKS**



Model	Function	Finish							List Price
		3	5	15/15A	26/26D	690/11P	514	NA	
83001	Signatures Entry Lever Screw Pack Styles: HFL, LSL, MIL, MRL, SYL			•	•	•			\$4.60
820284	Signatures Passage & Privacy Lever Screw Pack Styles: HFL, LSL, MIL, MRL, SYL			•	•	•			\$3.15
83523	Light Commercial Screw Pack Style: Kingston	•		•	•	•			\$3.45
83524	Light Commercial Screw Pack Style: BBL,CNL,PLL	•		•	•	•			\$3.45
83258	Lever Set Screw With Hex Wrench (3/32")							•	\$0.65
83398	Lever Set Screw With Hex Wrench for MRL, SYL, HFL, LSL, MIL							•	\$5.25

**REVERSIBLE LEVERSET SCREWS**



Model	Function	Finish							List Price
		3	5	15/15A	26/26D	690/11P	514	NA	
83258	New Reversible Lever Hex Wrench (3/32")							•	\$0.65
83254	Passage/Privacy/Interior Entry SMT							•	\$0.20
83255	Interior Pin & Tumbler Entry							•	\$0.20
83256	Exterior Entry Pin & Tumber							•	\$0.20
83257	Exterior Entry SMT							•	\$0.20

**HANDLESETS**

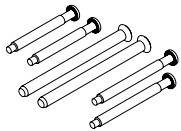

Model	Function	Finish							List Price
		3	5	15/15A	26/26D	690/11P	514	NA	
86151	Kwikset Handleset Screw Pack Styles: A, CA, H, L, ADL, AVL, BRL, CHL, PML, CE, AVH, ADH, SE, HE	•	•	•	•	•			\$1.25



Model	Function	Finish							List Price
		3	5	15/15A	26/26D	690/11P	514	NA	
82215	Signatures Handleset Decorative Interior Screw Cap Cover Styles: ADH, AVH, AT, HE, SE, TVH, AVH, MNH	•	•	•	•	•	•		\$2.05



82213	Screw & Washer							•	\$0.75
81696	Signature Series Handleset Cap for 818 and 819 CMH and SCE			•	•	•			\$2.05
83004	Signature Series Handleset Screw and Washer for 818 and 819 CMH and SCE							•	\$0.75

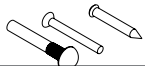

Model	Function	Finish							List Price
		3	5	15/15A	26/26D	690/11P	514	NA	
88322	Sex Nut Set & Wood Screw AN, CE, AMD, BW, DA	•	•	•	•	•			\$5.50

<b>DEADBOLTS</b>	Model	Function	Finish						List Price	
			3	5	15/15A	26/26D	690/11P	514		NA
	86171	660 Deadbolt Screw Pack	•	•	•		•			\$1.25
	86099	665 Deadbolt Screw Pack	•	•	•	•	•			\$2.05
	86073	One-Way Screws, 665 Deadbolt	•	•	•	•	•			\$1.15
	81247	P&T and SMT 780/782/980/982 Deadbolt Screw Pack	•	•	•	•	•			\$4.25
	81251	980 Series Deadbolt, Turnpiece Screw & Wrench							•	\$4.25
	83474	P&T and SMT 784, 785, 984, 985 Deadbolt Screw Pack	•	•	•	•	•			\$9.15
	820285	P&T and SMT 158 Deadbolt Screw Pack			•	•	•			\$4.25
	820286	P&T and SMT 159 Deadbolt Screw Pack			•	•	•			\$9.15
	83015	Standard Screw Pack for 258 Series Deadbolt			•	•		•		\$5.25
	83017	Thin Door Screw Pack for 258 Series Deadbolt			•	•		•		\$5.25

<b>DUMMY/ IN-ACTIVE</b>	Model	Function	Finish						List Price	
			3	5	15/15A	26/26D	690/11P	NA		
	81708	488 & 788 Dummy Mounting Screws	•	•	•	•	•			\$1.05
	81892	488 Dummy Adapter	•	•	•	•	•			\$5.40
<b>LATCH</b>	<b>Model</b>	<b>Function</b>	<b>Finish</b>						<b>List Price</b>	
	81711	Latch & Strike Screws	•	•	•	•	•			\$0.70
	82893	3846 Strike Screw Pack	•	•	•	•	•			\$2.80

**ADJUSTABLE INTERCONNECT**

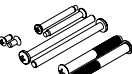
	Model	Function	Finish						List Price
			3	5	15/15A	26/26D	690/11P	NA	
	83269	Adjustable Interconnect Screw Pack	•	•	•	•	•		\$2.70

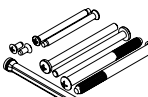
	83270	Adjustable interconnect Screw Pack (Thick Door Pack)	•	•	•	•	•		\$2.70
---	-------	--	---	---	---	---	---	--	--------

**STRIKES**

	Model	Function	Finish						List Price
			3	5	15/15A	26/26D	690/11P	NA	
	86356	3" Strike Screws	•	•	•	•	•		\$4.35

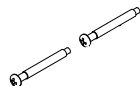
	88604	Full Round Strike Screws				•			\$1.25
---	-------	--------------------------	--	--	--	---	--	--	--------

**THICK DOOR CONVERSION**

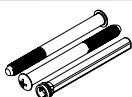
	Model	Function	Finish							List Price
			3	5	15/15A	26/26D	690/11P	NA		
	81691	P&T and SMT 780/782/980/982 Deadbolt Thick Door Pack	•	•	•	•	•		\$5.00	

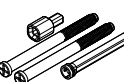
	83022	258 Series Deadbolt Thick Door Pack			•	•		•	\$5.00
--	-------	-------------------------------------	--	--	---	---	--	---	--------

	81249	P&T and SMT 784/785 Deadbolt Thick Door Kit with 2-11/16" Screws						•	\$5.00
---	-------	--	--	--	--	--	--	---	--------

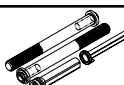
	84221	P&T Deadbolt Thick Door Kit with 3.625" Screws						•	\$5.00
---	-------	--	--	--	--	--	--	---	--------

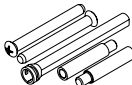

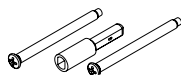

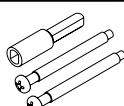
	86129	660 Thick Door Pack	•	•	•	•	•		\$5.00
	86130	665 Thick Door Pack	•	•	•	•	•		\$5.00

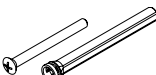

	81714	Thick Door Pack, Signature Series Knobs Concealed Screws Styles						•	\$5.00
---	-------	---	--	--	--	--	--	---	--------

	81706	Thick Door Pack, Kwikset and Signatures Knob & Lever Styles: A, CA, CN, PE, H, AO, CV, P, T, BL, DL, DNL, LRL, ADL, AUL, AVL, BRL, CHL, L, LL, TNL, PML, KTL, VDL	•	•	•	•	•	•	\$5.00
---	-------	---	---	---	---	---	---	---	--------

	81838	Thick Door Pack, Handleset Adapter	•	•	•	•	•	•	\$2.70
---	-------	------------------------------------	---	---	---	---	---	---	--------

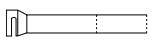
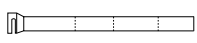
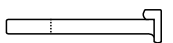
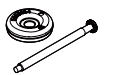

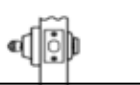









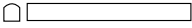
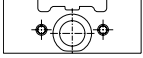
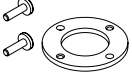
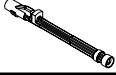
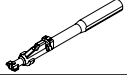

**THICK DOOR  
CONVERSION  
(CONT)**

Model	Function	3	5	15/15A	26/26D	690/11P	NA	List Price
 81781	Thick Door Pack, All Active & Dummy Handlesets	•	•	•	•	•		\$5.00
 820291	Thick Door Pack for 154 and 155 Function for the Styles HFL, LSL, MIL, MRL, and SYL. No Thick Door Kit is available for the 156 function.			•	•	•		\$5.00
 820289	P&T and SMT 158 Deadbolt Thick Door Pack			•	•	•		\$5.00
 820290	P&T and SMT 159 Deadbolt Thick Door Pack			•	•	•		\$5.00
 84988	1.37" Torque Blade Double Cylinder Thick Door							\$1.60
 84992	2.491" Torque Blade Single Cylinder Thick Door							\$1.60
 84994	1.40" Torque Blade Thick Door						•	\$1.10
 81861	Thick Door Screw and Washer							\$1.20

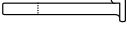





Model	Function	Amherst, Ashfield, Avalon, Hawthorne, Shelburne, Tavaris	Austin	Arlington, Chelsea	San Clemente, Camino	Amador, Belleview, Dakota
 81691	980 Deadbolt Thick Door Pack (H16)	X	X	X		
83022	258 Deadbolt Thick Door Pack (H16)				X	
86129	660 Deadbolt Thick Door Pack (H17)					X
 81402	Handleset Thick Door Spindle (H18)	X	X	X	X	X
81780	Thick Door Pack for all Handlesets (H17)	X	X	X	X	X
 82213	Throughbolt Screw & Washer (H14)	O	X			
81861	Thick Door Screw & Washer (H17)				X	
88322	Sex Nut & Wood Screw Set (H14)			O		

**U:** Needed for thick door option  
**O:** Optional - Part comes with product on standard order  
 Must specify finish on order

MISC. PARTS	Model	Function	Finish							List Price	
			3	5	15	15A	26	26D	11P		N/A
	82768	660/665 Cylinder Guard								•	\$3.45
	87760	780 Cylinder Guard								•	\$3.55
	82746	660/665 Cylinder Guard Cover	•	•	•	•	•	•	•		\$4.35
	87759	780 Cylinder Guard Cover	•	•	•	•	•	•	•		\$8.15
	82216	980 Cylinder Guard Cover	•	•	•	•	•	•	•		\$8.15
	84991	660 Torque Blade								•	\$1.80
	83273	660/663/667/677/588 Thumb Turn	•	•	•	•	•	•	•		\$7.10
	81692	780 Thumb Turn	•	•	•	•	•	•	•		\$20.20
	82217	980 Thumb Turn Exposed Screws	•	•	•	•	•	•	•		\$20.20
	88381	665, 667, 677 Exterior Plate	•	•			•	•	•		\$16.40
	81295	Kwik-Install Mounting Plate								•	\$2.80
	87789	Deadbolt Reinforcing Plate								•	\$1.35
	82778	699 Function Dummy Cylinder	•	•	•	•	•	•			\$4.55
	81402	800 Handleset Thick Door Spindle								•	\$1.70

MISC. PARTS	Model	Function	Finish							List Price	
			3	5	15	15A	26	26D	11P		N/A
	81239	Grade 1 Body Dummy Cylinder								•	\$10.55
	81226	Dummy Cylinder Cover	•	•	•	•	•	•	•		\$3.05
	84990	663/667/677/664 Tailpiece								•	\$1.80
	84568	663 Block, Bolt Mounting								•	\$1.05
	81404	Non-Handed Levers Dummy Adapter								•	\$10.90
	88841	300 Knobs Interior Round Spindle								•	\$0.65
	87628	740 Interior Round Spindle								•	\$0.95
	85624	3-1/2" Screw Driver Bit (10 Pack)								•	\$5.25
	88448	U.L. Shield Knobs and Levers								•	\$5.10
	81857	U.L. Shield Deadbolts								•	\$5.10
	81822	DB 2-1/8" Adapter for 780/980								•	\$2.80
	84987	.835" Torque Blade								•	\$1.70
	84993	1.097" Torque Blade, Standard Door								•	\$1.70
	83621	Finish Sample Ring								•	\$14.60
	83024	258 Series Mounting Plate								•	\$3.15
	83369	Vedani Lever Support Insert								•	\$3.30
	85333	Half Round & Round Spindle Assembly								•	\$3.85
	85570	5570-07 Screw #8-32 x 1-1/2			•						\$0.10
	820314	Levers and Knobs Frost Insert								•	\$6.30

**ELECTRONIC SERVICE PARTS**

	Model	Function	Finish									List Price
			3	L03	5	15	15A	26	26D	11P	N/A	
	83306	909 Top Cover			•		•					\$11.55
	83307	909 & 911 Top Battery Holder									•	\$1.75
	83648	953 Interior Cover					•				•	\$29.35
	83650	953 Interior Chasis									•	\$89.95
	83647	953 Exterior Assembly					•				•	\$129.95
	83651	953 Mounting Screws for 1-3/8" Door Thickness									•	\$5.05
	83652	953 Mounting Screws for 1-3/4" Door Thickness									•	\$5.05
	83653	953 Mounting Screws for 2" Door Thickness									•	\$5.05