

R&H Wholesale Supply Inc.

OVER 13,000 PRODUCTS
FROM OVER
100 DIFFERENT MANUFACTURERS



CONTENTS

PLS	4-5	CYLINDERS	54-55
DONJO	6-10	CYLINDERS I/C CORE	56
ENTRY ARMOR	11-13	HARDWARE I/C CORE	57
HPC	14-19	PINNING KITS	58
LUCKY LINE	20-25	PINNING TOOLS	59
CABINET HARDWARE	26-30	PADLOCKS	60-71
ACCESS CONTROL	31-40	KEY MACHINES	72-75
COMMERCIAL HARDWARE	42-50	SAFES	76-78
RESIDENTIAL HARDWARE	51-53		



ABOUT US

R&H Wholesale Supply is a wholesale distributor of door hardware and locksmith supplies located in San Francisco since 1949. We currently carry over 13,000 products from over 100 different manufacturers.

RETURNS

For items other than electronic merchandise, special orders and software, returns are allowed within 30 days of invoice with an approved RGA (Returned Goods Authorization). All electronic merchandise and software are non-refundable. Items must be in original condition, unopened, and uninstalled. All return goods are subject to 15% minimum restocking fee. Warranties are subject to manufacturers policy.

WE CARE ABOUT OUR CUSTOMERS SO WE GET OUR ORDERS OUT ON TIME!

Orders Placed before 4 P.M Ship the same day!

*Some exclusions apply, please call for details

FREE FREIGHT

Orders in excess of **\$350.00** (within Northern California) will be shipped prepaid. All other orders in excess of **\$500.00** will be shipped prepaid within the Continental United States.

*Some items like safes, key machines, and promotional items may not be included in our free freight policy. Shipments will be made via UPS or the best available carrier of our choice.

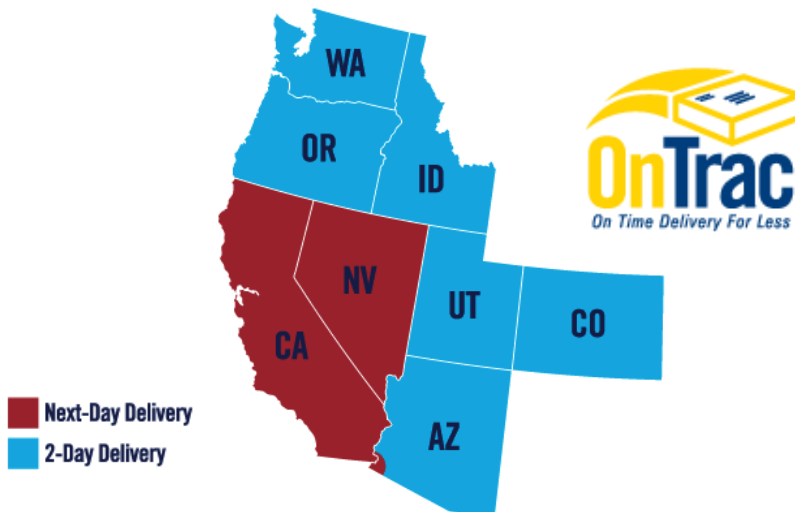
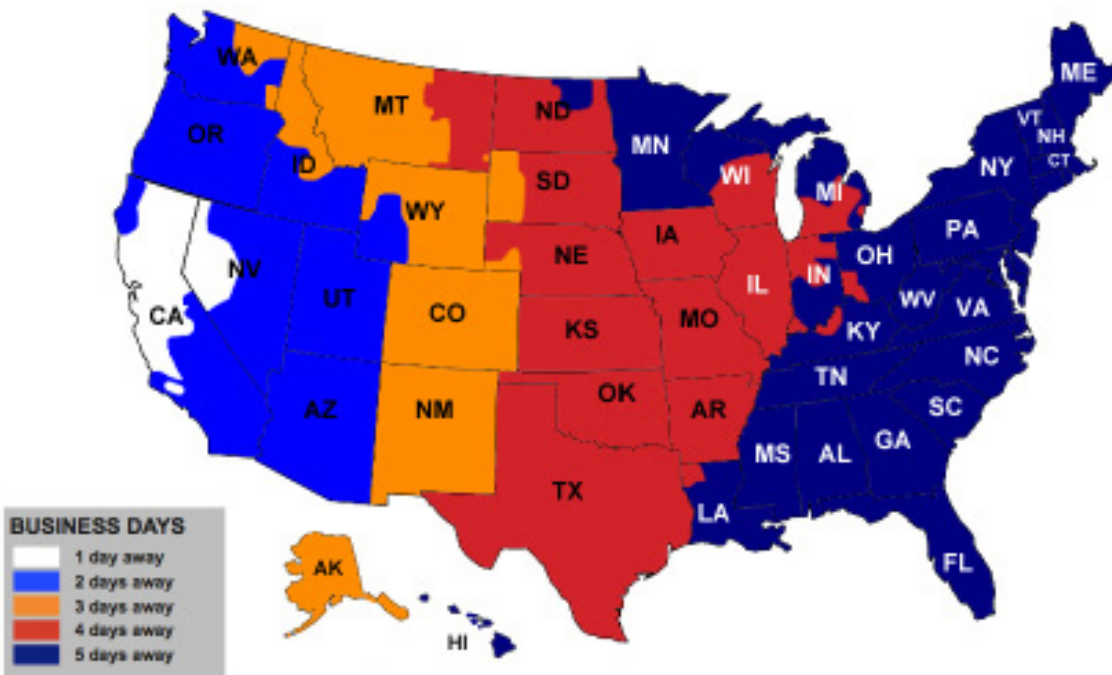

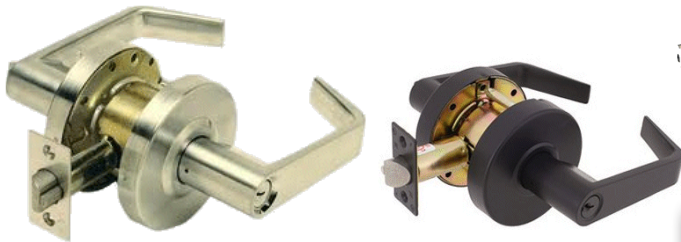

PLS Clutched- Grade 1		26D	
CL110 Passage	Stock		
CL140 Privacy	Stock		
CL153 Entrance	Stock		
CL170 Classroom	Stock		
CL180 Storeroom	Stock		
PLS- Grade 2		26D	10B
L210 Passage	Stock	Stock	Stock
L240 Privacy	Stock	Stock	Stock
L253 Entrance	Stock	Stock	Stock
L270 Classroom	Stock		
L280 Storeroom	Stock	Stock	Stock
PLS Clutched- Grade 2		26D	10B
CL253 Entrance	Stock		Stock
CL280 Storeroom	Stock		

PLS Knobs- Grade 2		32D	US5	US3	10B
K210 Passage		Stock		Stock	
K240 Privacy		Stock		Stock	
K253 Entrance		Stock	Stock	Stock	Stock
K270 Classroom		Stock			
K280 Storeroom		Stock		Stock	Stock
PLS Knobs- Grade 3		32D	US5	US3	15
K353 Entrance		Stock	Stock	Stock	Stock
K380 Storeroom		Stock		Stock	
K353 Entrance	KW1 Keyway	Stock		Stock	
K380 Storeroom	KW1 Keyway	Stock			
PLS Deadbolts- Grade 1 & 2		32D		US3	10B
DB160 Single Cyl		Stock		Stock	
DB260 Single Cyl		Stock		Stock	Stock
DB262 Double Cyl		Stock		Stock	
PLS Deadbolts- Grade 3		32D	US5	US3	15
DB360 Single Cyl		Stock	Stock	Stock	Stock
DB360 Single Cyl	KW1 Keyway	Stock	Stock	Stock	

*All Locks Standard Schlage "C" keyway

*All Locks Standard Schlage "C" keyway



TYLO STYLE KNOB

400T

- Finishes: Brass, Antique Brass, Satin Chrome
- KW1 Keyway



PUSH/PULL PADDLE

GHPULL-AL

- Aluminum
- Reversible

GHPUSH-DU

- Durotic
- Reversible



DEADLATCH LEVER

GHDLL-AL

- Aluminum
- GHDLL-DU
- Durotic



DEADBOLT MORTISE

GHDB118

- Size: 1-1/8"

GHDB3132

- Size: 31/32"

- Aluminum & Durotic



HOOKBOLT MORTISE

GHHB118

- Size: 1-1/8"

GHHB3132

- Size: 31/32"

- Aluminum & Durotic

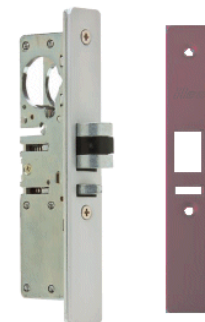

DEADLATCH MORTISE

GHDL3132

- Size: 31/32"

GHDL118

- Size: 1-1/8"

- Specify Handing
- Aluminum & Durotic

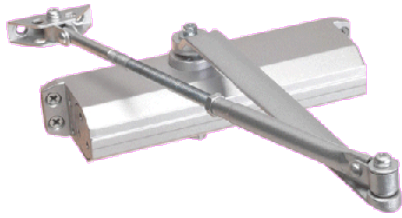

PLS CLOSER SIZE 1-4

DC1614-AL

- Aluminum
- DC1614-DU**
- Duronotic
 - Heavy Duty Grade 1 Commercial
 - Spring power adjustable: 1-4
 - Fits Norton 1601 Foot Print
 - CTC: 9-1/16" x 3/4"



PLS CLOSER SIZE 3-6

DC1636-AL

- Aluminum
- DC1636-DU**
- Duronotic
 - Heavy Duty Grade 1 Commercial
 - Spring power adjustable: 3-6
 - Fits Norton 1601 Foot Print
 - CTC: 9-1/16" x 3/4"

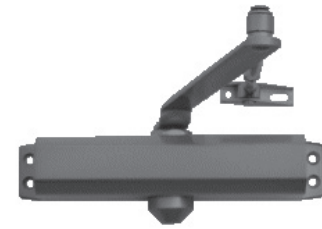

PLS CLOSER SIZE 3

DC330-AL

- Aluminum
- DC330-DU**
- Duronotic
 - Heavy Duty Grade 1 Commercial
 - Spring power size: 3
 - Fits Norton 1601 Foot Print
 - CTC: 9-1/16" x 3/4"

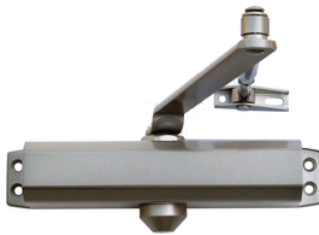

PLS CLOSER SIZE 4

DC340-AL

- Aluminum
- DC340-DU**
- Duronotic
 - Heavy Duty Grade 1 Commercial
 - Spring power size: 4
 - Fits Norton 1601 Foot Print
 - CTC: 9-1/16" x 3/4"



PLS CLOSER SIZE 1-6

DC1916-AL

- Aluminum
- DC1916-DU**
- Duronotic
 - Heavy Duty Grade 1 Commercial
 - Spring power adjustable: 1-6
 - Fits LCN 4040 Foot Print



VERTICAL ROD EXIT DEVICE

RVR136-AL

- Aluminum
- 36" Door



RIM EXIT DEVICE 36"

RPB136-AL

- Aluminum
- Grade 1 Rim Exit Device 36"



EXIT TRIM

RLR53-26D

- Entry/Classroom
 - Chrome
- RLR80-26D**

- Storeroom
- Lever

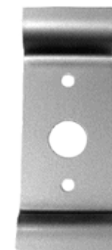

WING PULL

R8P03-AL

- Aluminum
- Wing Pull With Cylinder hole
- Rim Cylinder not included

Door Closers

Exit Devices & Trim

CYLINDRICAL LOCK- 2 1/8" HOLE

- 4 x 9" Size, 2-3/8" Backset**
 1-3/8" Door Thickness
1-CW-PB
 • Polished Brass
1-CW-AB
 • Antique Brass
1-CW-S
 • Stainless Steel
- 1-3/4" Door Thickness**
2-CW-PB
 • Polished Brass
2-CW-AB
 • Antique Brass
2-CW-S
 • Stainless Steel

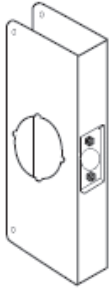

DEADBOLTS- 1 1/2" HOLE

- 4 x 4-1/2" Size, 2-3/8" Backset**
 1-3/8" Door Thickness
5-CW-PB
 • Polished Brass
5-CW-AB
 • Antique Brass
5-CW-S
 • Stainless Steel
- 1-3/4" Door Thickness**
6-CW-PB
 • Polished Brass
6-CW-AB
 • Antique Brass
6-CW-S
 • Stainless Steel



DEADBOLTS- 2 1/8" HOLE

- 4 x 4-1/2" Size, 2-3/8" Backset**
 1-3/8" Door Thickness
51-CW-PB
 • Polished Brass
51-CW-AB
 • Antique Brass
51-CW-S
 • Stainless Steel
- 1-3/4" Door Thickness**
61-CW-PB
 • Polished Brass
61-CW-AB
 • Antique Brass
61-CW-S
 • Stainless Steel



- 4-1/2 x 9" Size, 2-3/4" Backset**
 1-3/8" Door Thickness
3-CW-PB
 • Polished Brass
3-CW-S
 • Stainless Steel
- 1-3/4" Door Thickness**
4-CW-PB
 • Polished Brass
4-CW-AB
 • Antique Brass
4-CW-S
 • Stainless Steel

- 4-1/4 x 4-1/2" Size, 2-3/4" Backset**
 1-3/8" Door Thickness
7-CW-PB
 • Polished Brass
7-CW-AB
 • Antique Brass
7-CW-S
 • Stainless Steel
- 1-3/4" Door Thickness**
8-CW-PB
 • Polished Brass
8-CW-AB
 • Antique Brass
8-CW-S
 • Stainless Steel

- 4-1/4 x 4-1/2" Size, 2-3/4" Backset**
 1-3/8" Door Thickness
71-CW-PB
 • Polished Brass
71-CW-S
 • Stainless Steel
- 1-3/4" Door Thickness**
81-CW-PB
 • Polished Brass
81-CW-S
 • Stainless Steel



12" HEIGHT

- 12-CW-PB**
 • Polished Brass
12-CW-S
 • Stainless Steel
 • 1-3/4" Door Thickness
 • 2-3/4" Backset
 • 2-1/8" Hole
 • Size: 4-1/4" x 12"

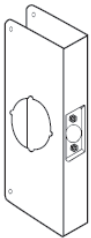

12" HEIGHT

- 12-2-CW-S**
 • Stainless Steel
 • With thru-bolt holes
 • 1-3/4" Door Thickness
 • 2-3/4" Backset
 • 2-1/8" Hole
 • Size: 4-3/4" x 12"

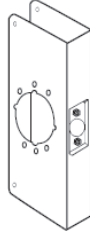

DOUBLE LOCK

- 154-CW-PB**
 • Polished Brass
154-CW-AB
 • Antique Brass
154-CW-S
 • Stainless Steel
 • 1-3/8" Door Thickness
 • 2-3/8" Backset
 • 1-1/2" Top Hole
 • 2-1/8" Bottom Hole
 • 4" Centers
 • Size: 4" x 9"



DOUBLE LOCK

- 264-CW-PB**
 • Polished Brass
264-CW-AB
 • Antique Brass
264-CW-S
 • Stainless Steel
 • 1-3/4" Door Thickness
 • 2-3/8" Backset
 • 1-1/2" Top Hole
 • 2-1/8" Bottom Hole
 • 4" Centers
 • Size: 4" x 9"



DOUBLE LOCK

- 484-CW-PB**
 • Polished Brass
484-CW-AB
 • Antique Brass
484-CW-S
 • Stainless Steel
 • 1-3/4" Door Thickness
 • 2-3/4" Backset
 • 1-1/2" Top Hole
 • 2-1/8" Bottom Hole
 • 4" Centers
 • Size: 4-1/4" x 9"

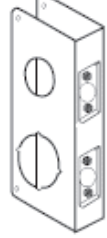

DOUBLE LOCK

- 151-CW-PB**
 • Polished Brass
151-CW-AB
 • Antique Brass
151-CW-S
 • Stainless Steel
 • 1-3/8" Door Thickness
 • 2-3/8" Backset
 • 2-1/8" Hole
 • 3-5/8" Centers
 • Size: 4" x 9"

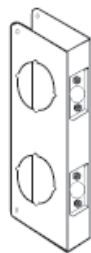

DOUBLE LOCK

- 261-CW-PB**
 • Polished Brass
261-CW-AB
 • Antique Brass
261-CW-S
 • Stainless Steel
 • 1-3/4" Door Thickness
 • 2-3/8" Backset
 • 2-1/8" Hole
 • 3-5/8" Centers
 • Size: 4" x 9"



DOUBLE LOCK

- 481-CW-PB**
 • Polished Brass
481-CW-S
 • Stainless Steel
 • 1-3/4" Door Thickness
 • 2-3/4" Backset
 • 3-5/8" Centers
 • 2-1/8" Hole
 • Size: 4-1/4" x 9"

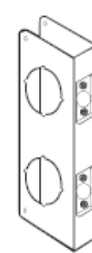

DOUBLE LOCK

- 942-CW-PB**
 • Polished Brass
942-CW-S
 • Stainless Steel
 • 1-3/4" Door Thickness
 • 2-3/8" Backset
 • 2-1/8" Hole
 • 4" Centers
 • Size: 4" x 9"



DOUBLE LOCK

- 943-CW-PB**
 • Polished Brass
943-CW-S
 • Stainless Steel
 • 1-3/4" Door Thickness
 • 2-3/4" Backset
 • 2-1/8" Hole
 • 4" Centers
 • Size: 4-1/4" x 9"

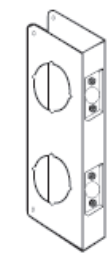

BLANK WRAP PLATE

- 30-CW-PB**
 • Polished Brass
30-CW-S
 • Stainless Steel
 • 1-3/8" Door Thickness
 • Size: 4-1/4" x 9"



BLANK WRAP PLATE

- 40-CW-PB**
 • Polished Brass
40-CW-S
 • Stainless Steel
 • 1-3/4" Door Thickness
 • Size: 4-1/4" x 9"



BLANK WRAP PLATE

- 70-CW-PB**
 • Polished Brass
70-CW-S
 • Stainless Steel
 • 1-3/8" Door Thickness
 • Size: 4-1/4" x 4-1/2"



BLANK WRAP PLATE



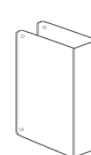





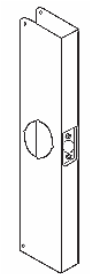

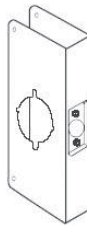
- 80-CW-PB**
 • Polished Brass
80-CW-AB
 • Antique Brass
80-CW-S
 • Stainless Steel
 • 1-3/4" Door Thickness
 • Size: 4-1/4" x 4-1/2"

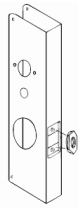

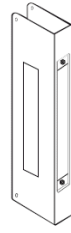
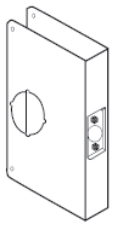
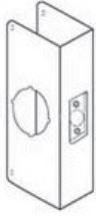
20" CYLINDRICAL

- 20-CW-PB**
 • Polished Brass
 • 1-3/4" Door Thickness
 • 2-3/4" Backset
 • Size: 5" x 20"

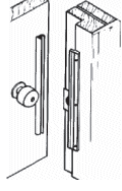
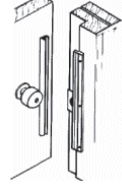
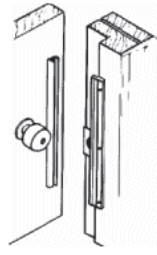
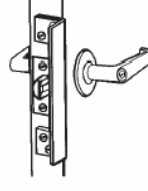
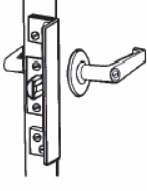
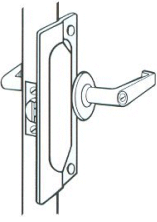
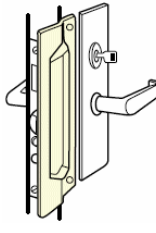
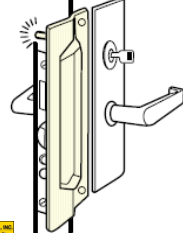

<p>20" CYLINDRICAL 20C-CW-PB</p> <ul style="list-style-type: none"> Polished Brass 1-3/4" Door Thickness 2-3/8" Backset Size: 5" x 20"  <p>DONJO</p>	<p>BEST/SARGENT 9K-CW-S</p> <ul style="list-style-type: none"> Stainless Steel For Best and Sargent Lever Locks 1-3/4" Door Thickness 2-3/4" Backset Size: 4-3/4" x 9"  <p>DONJO</p>	<p>SCHLAGE LEVER 4-2-CW-PB</p> <ul style="list-style-type: none"> Polished Brass 4-2-CW-10B Duronotic 4-2-CW-S Stainless Steel 1-3/4" Door Thickness 2-3/4" Backset 2-1/8" Hole Size: 4-3/4" x 9"  <p>DONJO</p>	<p>KABA WRAP PLATE</p> <p>Fits Simplex 1000 Series</p> <ul style="list-style-type: none"> 9-CW-AB Antique Brass 9-CW-S Stainless Steel 1-3/4" Door Thickness 2-3/4" Backset Size: 5" x 9"  <p>DONJO</p>	<p>KABA WRAP PLATE</p> <p>For Simplex 1,000 series and 5,000 series. 14" unit for Mortise.</p> <p>Conversion</p> <ul style="list-style-type: none"> 15-CW-S Stainless Steel 1-3/4" Door Thickness 2-3/4" Backset Size: 5" x 15"  <p>DONJO</p>
<p>TRILOGY WRAP 27-CW-S</p> <ul style="list-style-type: none"> Stainless Steel 1-3/4" Door Thickness 2-3/4" Backset Size: 5" x 15"  <p>DONJO</p>	<p>COVER SIMPLEX</p> <p>Conversion of Simplex 1000 Series & Alarm Lock DL2500, 2700/T2 & 3000.</p> <ul style="list-style-type: none"> 14-CW-PB Polished Brass 14-CW-S Stainless Steel 2-3/4" Backset Size: 5" x 14"  <p>DONJO</p>	<p>MORTISE WRAP</p> <p>Wrap Plate for 86 Cut-Out</p> <ul style="list-style-type: none"> 504-CW-S Stainless Steel 1-3/4" Door Thickness Recess: 8" x 1-1/4" Size: 5" x 12"  <p>DONJO</p>	<p>MORTISE WRAP</p> <p>Wrap Plate for 86 Cut-Out</p> <ul style="list-style-type: none"> 514-CW-S Stainless Steel 1-3/4" Door Thickness 2-3/4" Backset Recess: 8" x 1-1/4" Size: 5" x 12"  <p>DONJO</p>	<p>5" BACKSET WRAP 55-CW-PB</p> <ul style="list-style-type: none"> Polished Brass 55-CW-S Stainless Steel 1-3/4" Door Thickness 2-1/8" Bore Size: 6-1/2" x 9"  <p>DONJO</p>
<p>2" THICKNESS 200-CW-PB</p> <ul style="list-style-type: none"> Polished Brass 200-CW-S Stainless Steel 2" Door Thickness 2-3/4" Backset Size: 4-1/4" x 9"  <p>DONJO</p>	<p>2" THICKNESS 200C-CW-PB</p> <ul style="list-style-type: none"> Polished Brass 200C-CW-S Stainless Steel 2" Door Thickness 2-3/8" Backset Size: 4-1/4" x 9"  <p>DONJO</p>	<p>2-1/4" THICKNESS 214-CW-PB</p> <ul style="list-style-type: none"> Polished Brass 214-CW-S Stainless Steel 2-1/4" Door Thickness 2-3/4" Backset Size: 4-1/4" x 9"  <p>DONJO</p>	<p>DOOR REINFORCER 20-FE-PB</p> <ul style="list-style-type: none"> Polished Brass 20-FE-S Stainless Steel 1-3/4" Door Thickness Size: 4-1/2" x 1"  <p>DONJO</p>	<p>DOOR REINFORCER 10-FE-PB</p> <ul style="list-style-type: none"> Polished Brass 10-FE-S Stainless Steel 1 3/8" Door thickness Size: 4 1/2" x 1"  <p>DONJO</p>
<p>INSWING DOOR ILP-206-BP</p> <ul style="list-style-type: none"> Brass Plated ILP-206-DU Duronotic ILP-206-SL Silver Coated 6" For Key-In-Knob  <p>DONJO</p>	<p>INSWING DOOR ILP-212-BP</p> <ul style="list-style-type: none"> Brass Plated ILP-212-DU Duronotic ILP-212-SL Silver Coated 12" For Mortise Lock  <p>DONJO</p>	<p>INSWING DOOR ILP-213-DU</p> <ul style="list-style-type: none"> Duronotic 13" For Mortise Lock  <p>DONJO</p>	<p>OUTSWING DOOR ALP-206-BC</p> <ul style="list-style-type: none"> Brass Coated ALP-206-DU Duronotic ALP-206-SL Silver Coated 6" For Key-In-Knob  <p>DONJO</p>	<p>OUTSWING DOOR ALP-210-BC</p> <ul style="list-style-type: none"> Brass Coated ALP-210-DU Duronotic ALP-210-SL Silver Coated 10" For Mortise Lock  <p>DONJO</p>
<p>OUTSWING DOOR LP-207-BC</p> <ul style="list-style-type: none"> Brass Coated LP-207-DU Duronotic LP-207-SL Silver Coated Size: 2-3/4" x 7"  <p>DONJO</p>	<p>OUTSWING DOOR LP-211-BC</p> <ul style="list-style-type: none"> Brass Coated LP-211-DU Duronotic LP-211-SL Silver Coated Size: 3" x 11"  <p>DONJO</p>	<p>OUTSWING DOOR MLP-111-630</p> <ul style="list-style-type: none"> Stainless Steel For use on Mortise Lock Size: 3" x 11"  <p>DONJO</p>	<p>OUTSWING DOOR PMLP-111-630</p> <ul style="list-style-type: none"> Stainless Steel Size: 3" x 11"  <p>DONJO</p>	<p>OUTSWING DOOR PULP-111-BP</p> <ul style="list-style-type: none"> Brass Plated PULP-111-DU Duronotic PULP-111-626 Chrome PULP-111-SL Steel Plated Size: 3-1/2" x 11-3/4" Comes with Pin that prevents spreading of door  <p>DONJO</p>

Wrap Plates

Latch Guards

Latch Guards

OUTSWING DOOR

LP-111-630
 • Stainless Steel
 • Size: 3" x 11"

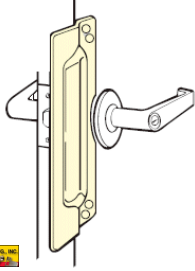

OUTSWING DOOR

PLP-111-630
 • Stainless Steel
 • Size: 3" x 11"

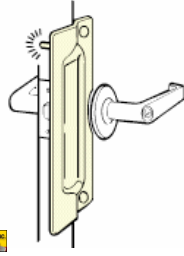

OUTSWING DOOR

NLP-106-630
 • Stainless Steel
NLP-206-DU
 • Duronotic
NLP-206-SL
 • Silver Coated
 • Size: 1-1/2" x 6"

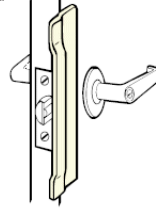

OUTSWING DOOR

NLP-110-630
 • Stainless Steel
NLP-210-DU
 • Duronotic
 • Size: 1-1/2" x 10"

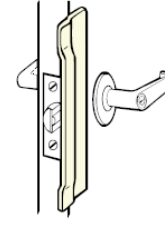

OUTSWING DOOR

MELP-210-DU
 • Duronotic
MELP-210-SL
 • Silver Coated
 • Fits most Electric Strikes
 • Mortise, Keyless Locks
 & Exit Devices
 • Size: 2-5/8" x 10"

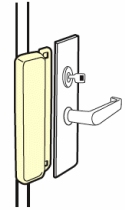

OUTSWING DOOR

LP-312-DU
 • Duronotic
LP-312-630
 • Stainless Steel
 • Size: 2-5/8" x 12"



OUTSWING DOOR

LP-312P-630
 • Stainless Steel
 • No Center Hole
 • Size: 2-5/8" x 12"



OUTSWING DOOR

LP-307-DU
 • Duronotic
LP-307-SL
 • Steel Coated
 • Size: 2-5/8" x 7"

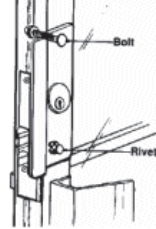

OUTSWING DOOR

SLP-206-SL
 • Silver Coated
 • Size: 2-1/2" x 6"

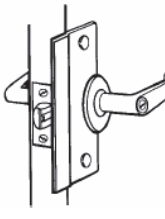

FOR RHODES LEVER

Outswing door with up to a 3-3/4" Rose.
BLP-107-630
 • Stainless Steel
BLP-207-BP
 • Brass Plated
BLP-207-DU
 • Duronotic
 • Size: 3-1/4" x 7"

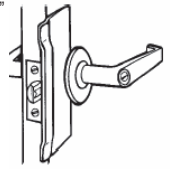

OUTSWING DOOR

LP-2878-DU
 • Duronotic
LP-2878-SL
 • Silver Coated
 • Size: 1-1/2" x 87/8"

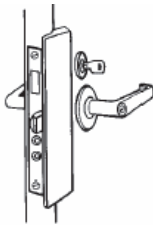

VERTICAL ROD

81-630
83-630
 • Stainless Steel
 • Left Hand Reverse or
 Right Hand Reverse
 • Size: 2-5/8" x 12"



VERTICAL ROD

85-630
 • Stainless Steel



FILLER PLATE

Electric Strike Filler Plate
AF-260-DU
 • Duronotic
AF-260-SL
 • Silver Coated
 • Size: 4-7/8" x 1 1/4"

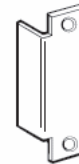

FILLER PLATE

Electric Strike Filler Plate With Hole
AF-261-DU
 • Duronotic
AF-261-SL
 • Silver Coated
 • Size: 4-7/8" x 1 1/4"



FILLER PLATE

EF-160-PC
 • Prime Coated
 • 160 cut out
 • Size: 2-1/4" x 1"



FILLER PLATE

EF-161-PC
 • Prime Coated
EF-161-S-PC
 • Prime Coated
 • 161 cut out
 • Size: 2-3/4" x 1-1/8"



FILLER PLATE

EF-86
 • Prime Coated
 • 86 cut out
 • Size: 8" x 1-1/4 x 3/16"



FILLER PLATE

BS-161-3
 • Polished Brass
BS-161-10B
 • Duronotic
BS-161-626
 • Chrome
 • Blank Strike
 • Size: 4-7/4" x 1-1/4"



FILLER PLATE

CV-86
 • Converts 86 cut out to 161
 • Size: 8" x 1-1/4"

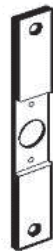

Filler Plates

FILLER PLATE

CV-8624
 • Converts 86 cut out to (2) 161
 • Size: 8" x 1-1/4"



HOLE FILLER

BF-161-BP
 • Brass Plated
BF-161-PC
 • Prime Coated
BF-161-SL
 • Silver Coated
 • Covers 2-1/8" hole
 • Diameter: 2-5/8"



HOLE FILLER

BF-178-BP
 • Brass Plated
BF-178-PC
 • Prime Coated
BF-178-SL
 • Silver Coated
 • Covers 1-1/2" hole
 • Diameter: 1-7/8"



HOLE FILLER











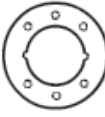

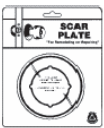

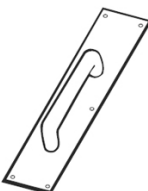

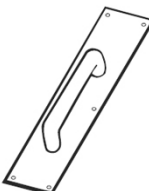

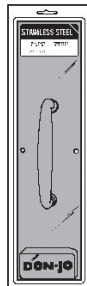

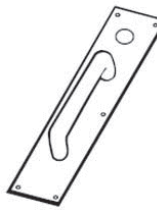



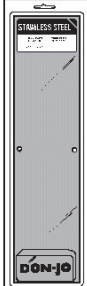





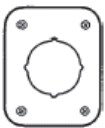





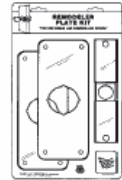







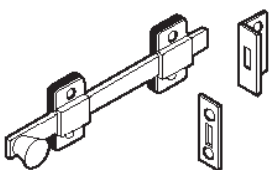



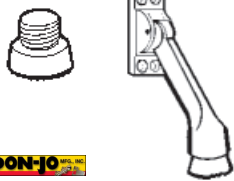

Covers up to 2 1/8" hole under rim panic device.
PDF-161-PC
 • Prime Coated
 • Diameter: 2-1/8"



HOLE FILLER

CP-258-BP
 • Brass Plated
CP-258-SL
 • Silver Coated
 • Indents at 3 & 9 o'clock to prevent collar from shifting
 • Diameter: 2-5/8"



<p>ADAPTER RING AR-335-605 • Polished Brass AR-335-613 • Durotonic AR-335-630 • Stainless Steel • Use on 1-3/8" Door • Diameter: 3-1/2"</p>  	<p>SCAR PLATE Fits under rose of Key in Knob or Deadbolt locks SP-135-605 • Polished Brass SP-135-609 • Antique Brass SP-135-630 • Stainless Steel • 3-1/2" O.D.</p>   	<p>PULL PLATE 7114-605 • Polished Brass 7114-630 • Stainless Steel • CTC: 5-1/2" • Pull: 3/4" • Size: 4" x 16"</p>  	<p>PULL PLATE 7115-628 • Aluminum 7115-630 • Stainless Steel • CTC: 6" • Pull: 3/4" • Size: 4" x 16"</p>  	<p>PULL PLATE PL13515-3 • Polished Brass PL13515-10B • Durotonic PL13515-630 • Stainless Steel • Size: 4" x 16"</p>  
<p>PULL W/ HOLE CFK-7115-638 • Stainless Steel • CTC: 6" • Pull: 3/4" • Bore: 2-1/8" • Size: 4" x 16"</p>  	<p>PUSH PLATE 71-605 • Polished Brass 71-628 • Aluminum 71-630 • Stainless Steel • Size: 4" x 16"</p>  	<p>PUSH PLATE PS13515-3 • Polished Brass PS13515-10B • Durotonic PS13515-630 • Stainless Steel • Size: 3-1/2" x 15"</p>  	<p>KICK PLATE 10X34-S • Stainless Steel • Size: 10 x 34"</p>  	<p>KICK PLATE KP-834-3 • Polished Brass KP-834-630 • Stainless Steel • Size: 8" x 34"</p>  
<p>REMODELER PLATE RP-13545-3 • Polished Brass RP-13545-630 • Stainless Steel • Size: 3-1/2" x 4-1/2"</p>  	<p>REMODELER PLATE RP-13509-3 • Polished Brass RP-13509-630 • Stainless Steel • Size: 3-1/2" x 9"</p>  	<p>REMODELER PLATE RP-13515-3 • Polished Brass RP-13515-630 • Stainless Steel • Size: 3-1/2" x 15"</p>  	<p>REMODELER PLATE RPK-109-3 • Polished Brass RPK-109-630 • Stainless Steel Kit Contains: • 2/EA RP-13509 • 1/EA CV-86-C & Fasteners</p>  	<p>SLIDE BOLT 2B-2-605 • Polished Brass 2B-2-626 • Chrome • Size: 2"</p>  
<p>SLIDE BOLT 3B-2-605 • Polished Brass 3B-2-626 • Chrome • Size: 3"</p>  	<p>SLIDE BOLT 4B-2-605 • Polished Brass 4B-2-626 • Chrome • Size: 4"</p>  	<p>SURFACE BOLT 1580-626 • Chrome • Size: 8"</p>  	<p>FLUSH BOLT 1550-DU • Durotonic 1550-SL • Silver Coated • Faceplate: 15/16" x 4-1/4" • Offset: 1/8"</p>  	<p>KICK DOWN 1465-626 • Chrome • Heavy Duty • Size: 4" Projection 1468 • Replacement Tip</p>  
<p>THIMBLE STRIKE TS-100-BP • Brass Plated TS-100-CP • Chrome • Diameter: 1"</p>  	<p>SECURITY STRIKE For Deadbolt 2-SDS-BP • Brass Plated 2-SDS-SL • Silver Coated • Size: 4-7/8" x 1-1/4"</p>  	<p>SECURITY STRIKE Super Strike for Deadbolt 2-SDS-8-BP • Brass Plated • Size: 8" x 1-3/8"</p>  	<p>SECURITY STRIKE For Key-In-Knob 2-SS-BP • Brass Plated • Size: 4-7/8" x 1-1/4"</p>  	<p>SECURITY STRIKE Adjustable for Key-In-Knob A-2-SS-SL • Silver Coated • Size: 1-3/4" x 3-3/8"</p>  

Push/Pull & Kick Plates

Remodel Plates

Surface Bolts & Kick Downs

Strikes

ANSI STRIKE

BS-161-3
 • Polished Brass
BS-161-10B
 • Duronic
BS-161-626
 • Chrome
 • Blank Strike
 • Size: 4-7/4" x 1-1/4"



ANSI STRIKE

ST-161-3
 • Polished Brass
ST-161-626
 • Chrome
 • Size: 4-7/8" x 1-1/4"



ANSI STRIKE

ST-261-BP
 • Brass Plated
ST-261-SL
 • Silver Coated
 • Size: 4-7/8" x 1-1/4"



KEY-IN-KNOB HOLE

Works with Key-In-Knob or Deadbolt
AST-21341-BP
 • Brass Plated
 • Size: 18" x 1 3/4"
FL-212N-BP
 • Brass Plated
 • Size: 12" x 1 3/8"
FL-212W-BP
 • Brass Plated
 • Size: 12" x 1 3/4"



MORTISE HOLE

Mortise "Universal" Center Hole
FL-212NM-BP
 • Brass Plated
 • Size: 12" x 1 3/8"
FL-212WM-BP
 • Brass Plated
 • Size: 12" x 1 3/4"



DOUBLE HOLE

3-5/8" & 4" Center Holes
FL-212N4-BP
 • Brass Plated
FL-212N4-SL
 • Silver Coated
 • Size: 12" x 1 3/8"
FL-212W4-BP
 • Brass Plated
FL-212W4-SL
 • Silver Coated
 • Size: 12" x 1 3/4"



DOUBLE HOLE

3-5/8" & 4" Center Holes
AST-21342-BP
 • Brass Plated
 • Size: 18" x 1 3/4"
AST-21382-BP
 • Brass Plated
 • Size: 18" x 1 3/8"



DOUBLE HOLE

6" Center Holes
AST-21346-BP
 • Brass Plated
 • Size: 18" x 1 3/4"
AST-21386-BP
 • Brass Plated
 • Size: 18" x 1 3/8"



DOUBLE HOLE

6" Center Holes
FL-212N6-BP
 • Brass Plated
 • Size: 12" x 1 3/8"
FL-212W6-BP
 • Brass Plated
 • Size: 12" x 1 3/4"



EXTENDED STRIKE

Size: 2-3/4" x 2"
ETS-102-605
 • Polished Brass
ETS-102-630
 • Stainless Steel

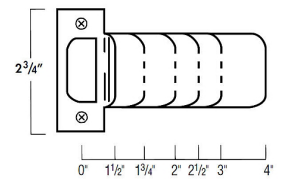

EXTENDED STRIKE

Size: 2-3/4" x 3"
ETS-103-605
 • Polished Brass
ETS-103-630
 • Stainless Steel

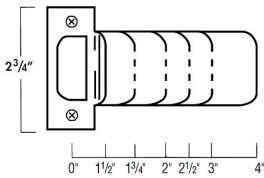

EXTENDED STRIKE

Size: 2-3/4" x 1-1/2"
ETS-115-605
 • Polished Brass
ETS-115-630
 • Stainless Steel

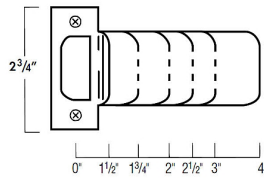

EXTENDED STRIKE

Size: 2-3/4" x 2-1/2"
ETS-125-605
 • Polished Brass
ETS-125-630
 • Stainless Steel

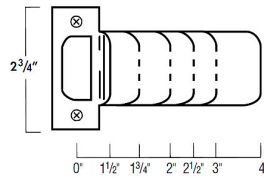

EXTENDED STRIKE

Size: 2-3/4" x 1-3/4"
ETS-175-605
 • Polished Brass
ETS-175-630
 • Stainless Steel

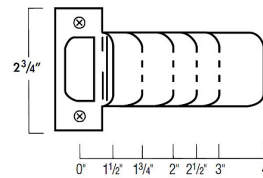

EXTENDED STRIKE

Size: 2-1/4" x 2"
EL-102-605
 • Polished Brass
EL-102-630
 • Stainless Steel

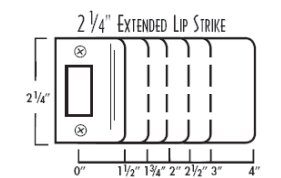

EXTENDED STRIKE

Size: 2-1/4" x 2-1/2"
EL-125-605
 • Polished Brass
 • Size: 2-1/4" x 2-1/2"

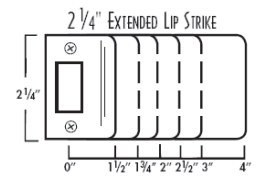

BALL BEARING

Standard Weight- For Medium Weight Doors/Average Frequency. Steel with Stainless Steel Pin.
BB74540-26D
 Size: 4-1/2" x 4"
BB74545-26D
 Size: 4-1/2" x 4-1/2"

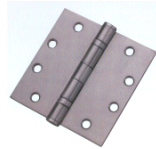

HEAVY DUTY HINGE

Heavy Weight- For Heavy Doors/High Frequency. Steel with Stainless Steel Pin. 3 hinges per box w/ screws. NRP Non-Removable Pin, Standard.
HWBB74545-26D
 Size: 4-1/2" x 4-1/2"

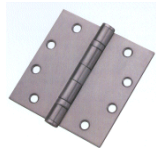

MENS HANDICAP

Size: 12" Triangle
CHS-1
 • Blue
 • Raised white lettering
 • Braille translation on sign



WOMENS HANDICAP

Size: 12" Round
CHS-1
 • Blue
 • Raised white lettering
 • Braille translation on sign



UNISEX HANDICAP

Size: 12" Round
CHS-1
 • Blue
 • Raised white lettering
 • Braille translation on sign



MENS HANDICAP

Size: 6" X 9"
HS-9070-01
 • Blue
 • Raised white lettering
 • Braille translation on sign



WOMENS HANDICAP

Size: 6" X 9"
HS-9070-05
 • Blue
 • Raised white lettering
 • Braille translation on sign



UNISEX HANDICAP

Size: 6" X 9"
HS-9070-32
 • Blue
 • Raised white lettering
 • Braille translation on sign



NO SMOKING

Size: 6" X 9"
HS-9070-22
 • Blue
 • Raised white lettering
 • Braille translation on sign



<p>2 1/8" HOLE EWP-121-S</p> <ul style="list-style-type: none"> • Stainless Steel • 1-3/8" Door Thickness • 2-3/8" Backset • Size: 4" x 9" 	<p>2 1/8" HOLE EWP-131-S</p> <ul style="list-style-type: none"> • Stainless Steel • 1-3/8" Door Thickness • 2-3/4" Backset • Size: 4-1/4" x 9" 	<p>2 1/8" HOLE EWP-123-S</p> <ul style="list-style-type: none"> • Stainless Steel • 1-3/4" Door Thickness • 2-3/8" Backset • Size: 4" x 9" 	<p>2 1/8" HOLE EWP-133-S</p> <ul style="list-style-type: none"> • Stainless Steel • 1-3/4" Door Thickness • 2-3/4" Backset • Size: 4-1/4" x 9" 	<p>1 1/2" HOLE EWP-111-S</p> <ul style="list-style-type: none"> • Stainless Steel • 1-3/4" Door Thickness • 2-3/4" Backset • Size: 4-1/4" x 4-1/2" 
<p>2 1/8" HOLE EWP-120-S</p> <ul style="list-style-type: none"> • Stainless Steel • 1-3/8" Door Thickness • 2-3/8" Backset • Size: 4" x 4-1/2" 	<p>2 1/8" HOLE EWP-122-S</p> <ul style="list-style-type: none"> • Stainless Steel • 1-3/4" Door Thickness • 2-3/4" Backset • Size: 4" x 4-1/2" 	<p>2 1/8" HOLE EWP-132-S</p> <ul style="list-style-type: none"> • Stainless Steel • 1-3/4" Door Thickness • 2-3/4" Backset • Size: 4-1/4" x 4-1/2" 	<p>2 1/8" HOLE EWP-130-S</p> <ul style="list-style-type: none"> • Stainless Steel • 1-3/8" Door Thickness • 2-3/4" Backset • Size: 4-1/4" x 4-1/2" 	<p>DOUBLE LOCK EWP-200-S</p> <ul style="list-style-type: none"> • Stainless Steel • 1-3/8" Door Thickness • 2-3/8" Backset • 1-1/2" Top Bore • 2-1/8" Bottom Bore • 4" Centers • Size: 4" x 9" 
<p>DOUBLE LOCK EWP-210-S</p> <ul style="list-style-type: none"> • Stainless Steel • 1-3/4" Door Thickness • 2-3/4" Backset • 1-1/2" Top Bore • 2-1/8" Bottom Bore • 4" Centers • Size: 4-1/4" x 9" 	<p>SCHLAGE LEVER EWP-161-S</p> <ul style="list-style-type: none"> • Stainless Steel • 1-3/4" Door Thickness • 2-3/4" Backset • 2-1/8" Hole • Size: 4-3/4" x 9" 	<p>5" BACKSET WRAP EWP-151-PB</p> <ul style="list-style-type: none"> • Polished Brass • 1-3/4" Door Thickness • 5" Backset • 2-1/8" Bore • Size: 6-1/2" x 9" 	<p>DOOR REINFORCER EWP-230-S</p> <ul style="list-style-type: none"> • Stainless Steel • 1-3/8" Door Thickness • Size: 4-1/4" x 1" 	<p>INSWING DOOR ELP-100-B</p> <ul style="list-style-type: none"> • Brass <p>ELP-100-DU</p> <ul style="list-style-type: none"> • Duronotic <p>ELP-100-C</p> <ul style="list-style-type: none"> • Chrome <p>• Size: 7"-5/8"</p> 
<p>INSWING DOOR ELP-110-B</p> <ul style="list-style-type: none"> • Brass <p>ELP-110-DU</p> <ul style="list-style-type: none"> • Duronotic <p>ELP-110-C</p> <ul style="list-style-type: none"> • Chrome <p>• Size: 12-5/8"</p> 	<p>OUTSWING DOOR ELP-210-DU</p> <ul style="list-style-type: none"> • Duronotic <p>ELP-210-S</p> <ul style="list-style-type: none"> • Stainless Steel <p>• Rose up to 3-1/2"</p> <p>• Size: 3" x 7"</p> 	<p>OUTSWING DOOR ELP-220-DU</p> <ul style="list-style-type: none"> • Duronotic <p>ELP-220-S</p> <ul style="list-style-type: none"> • Stainless Steel <p>• Left or Right Hand</p> <p>• Rose up to 3-1/2"</p> <p>• Size: 3" x 11"</p> 	<p>OUTSWING DOOR ELP-200-B</p> <ul style="list-style-type: none"> • Brass <p>ELP-200-AL</p> <ul style="list-style-type: none"> • Aluminum <p>ELP-200-C</p> <ul style="list-style-type: none"> • Chrome <p>• Size: 1-13/16" x 6"</p> 	<p>OUTSWING DOOR ELP-250-DU</p> <ul style="list-style-type: none"> • Duronotic <p>ELP-250-S</p> <ul style="list-style-type: none"> • Stainless Steel <p>• Includes 1 Spacer</p> <p>• Size: 3" x 11"</p> 
<p>OUTSWING DOOR ELP-250-1-DU</p> <ul style="list-style-type: none"> • Duronotic <p>ELP-250-1-S</p> <ul style="list-style-type: none"> • Stainless Steel <p>• Includes 1 Spacer</p> <p>• Size: 3" x 11"</p> 	<p>OUTSWING DOOR ELP-250-2-DU</p> <ul style="list-style-type: none"> • Duronotic <p>ELP-250-2-S</p> <ul style="list-style-type: none"> • Stainless Steel <p>• Includes 1 Spacer</p> <p>• Size: 3" x 11"</p> 	<p>OUTSWING DOOR ELP-240-DU</p> <ul style="list-style-type: none"> • Duronotic <p>ELP-240-S</p> <ul style="list-style-type: none"> • Stainless Steel <p>• Includes 1 Spacer</p> <p>• Size: 3-5/8" x 13"</p> 	<p>OUTSWING DOOR ELP-240-1-DU</p> <ul style="list-style-type: none"> • Duronotic <p>ELP-240-1-S</p> <ul style="list-style-type: none"> • Stainless Steel <p>• Includes 1 Spacer</p> <p>• Size: 3-5/8" x 13"</p> 	<p>OUTSWING DOOR ELP-240-2-DU</p> <ul style="list-style-type: none"> • Duronotic <p>ELP-240-2-S</p> <ul style="list-style-type: none"> • Stainless Steel <p>• Includes 1 Spacer</p> <p>• Size: 3-5/8" x 13"</p> 

Adaptor & Filler Plates

240 SERIES SPACER
ELP-240-XSP
• Spacer for Latch Protector
• Works with ELP-240's
• 3/PK

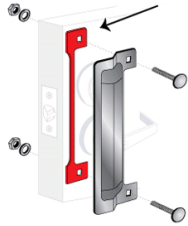

OUTSWING DOOR
ELP-310-DU
• Durotonic
ELP-310-AL
• Aluminum
• Size: 2-5/8" x 12"



INSWING/OUTSWING
ELP-120-AL
• Aluminum
• Size: 6" x 1 13/16"



ADAPTOR PLATE
EAP-100-B
• Brass
• Diameter: 2-5/8"
• Bore: 1-1/4"
• Includes 1 Part



ADAPTOR
EAP-110-B
• Brass
EAP-110-C
• Chrome
• Diameter: 2-3/4"
• Bore: 1-1/2"
• Includes 2 Part



HOLE FILLER
EAP-120-AB
• Antique Brass
EAP-120-B
• Brass
EAP-120-C
• Chrome
• Diameter: 3-1/2"
• Bore: 2-1/8"
• Includes 2 Part



HOLE FILLER
EHC-100-B
• Brass
EHC-100-PC
• Prime Coat
• Cover for 1-1/2" or 2-1/8"
• Diameter: 2-5/8"

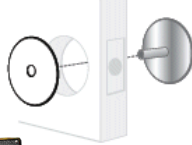

FILLER PLATE
EFP-100-PC
• Prime Coat
• Converts 86 cut-out to 161 prep
• Size: 8"-1-1/4"
• 3/8" off center line



FILLER PLATE
EFP-110-PC
• Prime Coat
• Size: 4-7/8"-1-1/4"



FILLER PLATE
EFP-120-PC
• Prime Coat
• Filler for 161 cut-out
• Size: 2-1/4"-1-1/8"



Door Accessories

FILLER PLATE
EFP-130-PC
• Prime Coat
• Filler for 86 Mortise cut-out
• Size: 8"-1-1/4"



FILLER PLATE
EFP-131-PC
• Prime Coat
• Filler for 160 cut-out
• Size: 2-1/4"-1"



DOOR GUARD
EDL-100-B
• Brass
EDL-100-C
• Chrome
• Size: 2-1/2" x 4"



CHAIN GUARD
EDL-110-AB
• Antique Brass
EDL-110-B
• Brass
• Size: 2-1/2" x 4-1/4"
• Chain: 3-5/8"



CHAIN GUARD
EDL-130-B
• Brass
• Key lock with 2 Keys included
• Size: 2-1/2" x 4-1/4"
• Chain: 3-5/8"

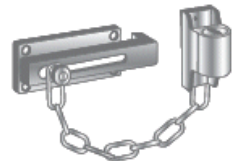

Patio Locks

PRIVACY FLIP LOCK
EFL-100-B
• Brass
• Inswing Doors
• Left or Right Hand
• Size: 2-3/4" x 1-1/2"



DOOR VIEW 160°
EDV-100-PB
• Brass
• Diameter: 1-1/2"
• Door: 1-3/8" to 2"



DOOR VIEW 190°
EDV-120-PB
• Polished Brass
EDV-120-C
• Chrome
• Diameter: 1-1/2"
• Door: 1-3/8" to 2"



DOOR VIEW 190°
EDV-130-PB
• Polished Brass
• Diameter: 1"
• Door: 1-3/8" to 2"

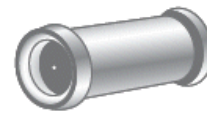

KNOB SET
EDK-100-PB
• Polished Brass
• Comes with Spindle

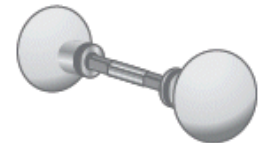

HASP LOCK
ELK-110-KA
ELK-110-KD
• Inswing Doors
• Left or Right Hand
• Keyed Alike or Keyed Different
• Size: 4-1/2" x 1-1/2"

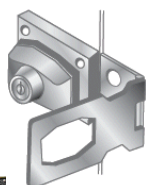

HASP LOCK
ELK-111-KA
ELK-111-KD
• Keyed Alike or Keyed Different
• Size: 2-1/2" x 2-3/4"

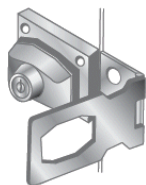

LEVER PATIO LOCK
EPL-100-AL
• Aluminum
• Inside and Outside Sliding Doors
• Size: 2" x 5/8"

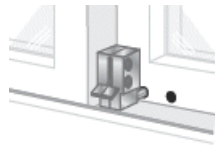



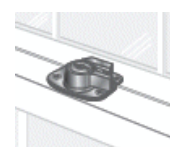











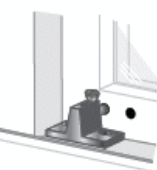

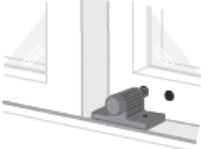





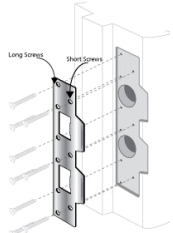





KEYED PATIO LOCK
EWL-111-B
• Brass
• Key lock with 2 Keys included

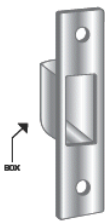

LEVER PATIO LOCK
EWL-120-AL
• Aluminum
• Lever



<p>KEYED PATIO LOCK EPL-106-AL • Aluminum EPL-106-W • White • Key lock with 2 Keys included • Inside and Outside Sliding Doors • Size: 6" x 1-1/8"</p>  	<p>PATIO LOCK EPL-108-W • White • No key required • Inside and Outside Sliding Doors • Size: 6" x 1-1/8"</p>  	<p>PIN PATIO LOCK EPL-110-AL • Aluminum • Cut to length • Pin locks in place • Length: 4-1/4"</p>  	<p>KNOB PATIO LOCK Top Knob Patio Lock EPL-101-AL • Aluminum EPL-101-W • White • Inside and Outside Sliding Doors • Size: 1-1/2" x 1-1/4"</p>  	<p>KNOB PATIO LOCK EPL-111-AL • Aluminum • Knob Patio Lock • Inside and Outside Sliding Doors • Length: 2" x 2-1/4"</p>  
<p>WINDOW LOCK Wing Nut Window Lock EWL-100-AL • Single Wing Nut EWL-150-AL • Aluminum • Double Wing Nut</p>  	<p>STRIKE PLATE ESP-110-B • Brass • Size: 8" x 1-1/4"</p>  	<p>STRIKE PLATE ESP-130-B • Brass • Size: 11" x 1-5/8"</p>  	<p>STRIKE PLATE ESP-140-C • Chrome • Size: 6" x 1-1/8"</p>  	<p>STRIKE PLATE ESP-141-B • Brass • Size: 7-3/4" x 1-5/8"</p>  
<p>STRIKE PLATE ESP-142-B • Brass • Size: 6" x 1-1/8"</p>  	<p>STRIKE PLATE ESP-143-B • Brass • Size: 4-7/8" x 1-1/4"</p>  	<p>STRIKE PLATE ESP-150-B • Brass ESP-150-C • Chrome • Size: 4-7/8" x 1-1/4"</p>  	<p>STRIKE PLATE ESP-180-B • Brass • Size: 2-3/4" x 1-1/8"</p>  	

Patio Locks

Strikes



Entry Armor provides you with residential and commercial security solutions.
 Buy now at R&H Wholesale!

Picks

BALL PICK

.022 Tip Thickness, Stainless Handle
BPX-41

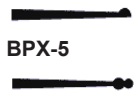

BPX-5



RAKE PICK

.022 Tip Thickness, Foam Handle
CPX-10



CPX-11



CPX-12



EXTRACTOR

.022 Tip Thickness
EZ-1



EZ-2



EZ-3



EZ-5



PICKING TOOL

.022 Tip thickness, Stainless Handle
LPX-10

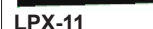

LPX-11



LPX-12



LPX-15



PICKING TOOL

.028 Tip thickness, Stainless Handle
HLPX-10

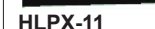

HLPX-11



HLPX-12



2000 SERIES

.020 Tip thickness, Picks
SSP-10
SSP-11
SSP-13
SSP-14

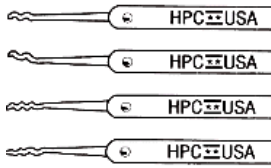

2000 SERIES

.020 Tip thickness, Extractors
SSX-10
SSX-11



TENSION WRENCHES

Variable Tension Wrenches
STW-3
STW-4

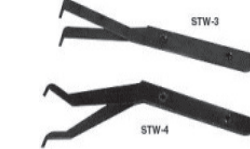

TENSION WRENCH

Double Sided Tension Wrenches
TEN-7
• Zinc Plated, Medium Tension
TEN-9
• Black, Rigid Tension



RIGID TENSION

TR-3
• 2-1/4" Straight
TR-4
• 2-1/4" Twist & Straight
TR-5
• 2-3/4" Single Side Straight
TR-6
• 3-3/4" Single Side Straight
VV-6
• 2" Double Sided Groove

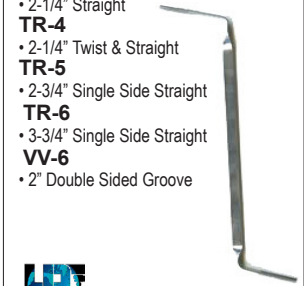

LIGHT TENSION

TR-7
• 3-1/4" Double Twist
TR-8
• 4" Double Twist
TR-9
• 5-1/4" Double Twist
TR-11
• 3-1/4" Single Side Twist
TR-12
• 4-1/2" Single Side Twist



MEDIUM TENSION

TR-13
• 3-1/4" Single Side Twist
TR-14
• 4-1/2" Single Side Twist
TR-23
• 3-1/4" Double Twist
TR-24
• 4" Double Twist
TR-25
• 5-1/4" Double Twist



TULIP TENSION

TR-2
• 3/4" Tension Tools
TR-2
• 1" Tension Tools

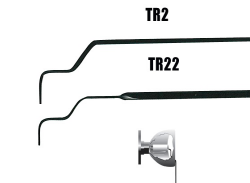

PICKING TOOL

.022 Tip thickness, Rake
P-11



P-12



LARGE HOOK PICK

.035 Tip thickness
HPX-31



Pick Sets

GRIP HANDLE PICK/GRIP

• PK/10
• 3/16" (4.75mm) round



DELUXE PICK SET

Shirt Pocket Size, Genuine Leather Case with Full Zipper, Hardened Spring Steel Components.

NDPK

• Contains: 10 Picks, 4 Tension Tools and 2 Extractors

NDPK-CASE

• Case only for NDPK, AKK, PIP



PRO-MIXER PICK SET

Shirt Pocket Size, Genuine Leather Case with Full Zipper, Hardened Spring Steel and Stainless Steel Components.

NDPK-24

Contains: 14 Picks, 5 Tension Tools and 5 Extractors



SUPERIOR PICK SET

Shirt Pocket Size, Genuine Leather Case with Full Zipper, Hardened Spring Steel Components.

NDPK-32

• Contains 22 Picks, 7 Tension Tools and 3 Extractors



PROFESSIONAL SET

Shirt Pocket Size, Genuine Leather Case with Full Zipper, Hardened Spring Steel Components.

NDPK-60

• Contains 40 Picks, 14 Tension Tools and 6 Extractors



STAINLESS STEEL

Shirt Pocket Size, Genuine Leather Case with Full Zipper, Hardened Spring Steel Components.

PIP-2000

• Contains 9 Picks, 3 Tension Tools, and 4 Extractors



NOVICE PICK SET

Shirt Pocket Size, Top Grain Leather Case with Snap, Hardened Spring Steel Components

PIP-13

• Contains 7 Picks, 3 Tension Tools and 1 Extractor



TYRO PICK SET

Shirt Pocket Size, Top Grain Leather Case with Snap, Hardened Spring Steel Components.

PIP-15

• Contains 6 Picks, 2 Tension Tools and 1 Extractor



EXTRACTOR SET

• Shirt Pocket Size, Genuine Leather Case with Snap, Stainless Steel Components.

ES-2000

• Contains 4 Extractors



DOUBLE-SIDED

The Double-Sided Pick Set contains 4 picks that can be used on the most popular double-sided, disc tumbler, showcase, cam, and padlocks

DSP-1

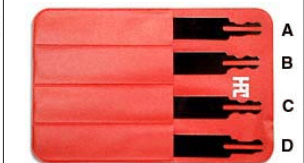

A
B
C
D

<p>COMPUTER PICKS 9 computer designed picks made of hardened stainless steel and 2 tension tools made of tempered spring steel. Comes in a genuine leather case with the TKPD-1 COMP-1</p>  	<p>EXTRACTOR SET EZ-6 • Includes 4 extractor blades stored inside a hollow handle • 1 saw type extractor blade • 2 round extractors .040 • 1 round extractor .050</p>  	<p>EXTRACTORS Replacement Extractors for EZ-6 EZ-7A • Saw type EZ-7B • .040 Round type EZ-7C • .050 Round type</p>  	<p>WALLET PICK SET Pants Pocket Size, Genuine Leather Wallet, Hardened Spring Steel and Stainless Steel Components. TFW-5 • Contains 4 Picks, 2 Tension Tools and 1 Extractor</p>  	<p>WARDER PADLOCK PKS • Compact Enough to Fit in your Pocket • Contains 5 Picks with Key Ring • Hardened Spring Steel Components</p>  
<p>PEN PICK SET The removable pocket clasp is also a tension tool. Contains 14 stainless steel picks (0.020 thickness) that are stored in the aluminum body. The removable pocket clasp is also a tension tool. VIPS-14</p>  	<p>11 PIECE PICK SET Contains 14 stainless steel picks (0.020 thickness) that are stored in the aluminum body. The removable pocket clasp is also a tension tool. PKX-11</p>  	<p>JACKKNIFE PICK Shirt Pocket Size, Spring Steel Components. Optional Genuine Leather Case with Snap JKP-5 • Contains 4 Picks and 1 Tension Tool</p>  	<p>TUBULAR PICK Works on 7-pin center locks including the small bore size. Features the Quick Reset button; just push the button and pump the barrel to reset the pick. Comes in a genuine leather case with the TKPD-1 decoder. TLB-7SB</p>  	<p>TUBULAR PICK Allows you to quickly manipulate all seven pins at one time and open the lock in seconds. Be prepared for students and coffee house surfers that lock down their laptop and misplace their keys TLB-7MB</p>  
<p>TUBULAR PICKS Model B TLB-CMOD-B • Permits infinitely variable tension against the feelers. • Comes in a genuine leather case with the TKPD-1</p>  	<p>PISTOL PICK GUN All parts are made from nickel-plated cold rolled steel for protection against rust. Designed to easily rake open pin and disc tumbler locks. Pistolpick comes with 3 pick blades and 2 tension wrenches HPG-10</p>  	<p>PICK GUN NEEDLES • Needles for EPG-1, HPG-10, and VIPS-14 P-2 • Straight Needle P-3 • Offset Needle R-1 • Rake</p>  	<p>ELECTRIC PICK GUN Original cordless rechargeable electric pick gun. Rakes open pin and disc tumbler cylinders. Complete with a 120VAC or 240VAC charger, 4 pick blades and 2 tension tools. EPG-1</p>  	<p>CHARGER FOR EPG EPGC-12 • 12 VDC Charger, for use with Electropicks™ with side contacts</p>  
<p>CYLINDER DRILL JIG CDJ-1 • Cylinder Drill Jig and Drill Bit for Flat Face Cylinder..</p>  	<p>CYLINDER DRILL JIG CDJ-3 • Cylinder Drill Jig recessed tulip design.</p>  	<p>CYLINDER EATER CE-6000 • This new drill attachment will chew up every cylinder you put in front of it!</p>  	<p>TUBULAR DRILL AG-1 • Standard Size Tool and Extra Saw for .375" (9.53mm) diameter.</p>  	<p>TUBULAR DRILL AG-2 • Oversize Tool and Extra Saw for .394" (10mm) diameter.</p>  
<p>PADLOCK DEFEATER RPD-10 • The Round Padlock Defeater allows you to drill a precise shear line in the cylinder on circular type padlocks.</p>  	<p>TUMBLER TWEEZER PTT-4 • The tip is also milled back so that the outside diameter of a standard .115" (2.92mm) pin extends past the tip.</p>  	<p>COMPACT TWEEZER PTT-5 • At only 4" (10cm) long, these tweezers allow you to get closer to the action.</p>  	<p>TWEEZERS TOP PIN TPT-5</p>  	<p>PULL FOLLOWER SUT-22 • Adjustable from 0.495"/12.6mm to 0.600"/15.2mm in diameter.</p>  

Pick Sets

Tubular Lock Picks

Pick Gun

Drills & Jigs

Tweezers & Followers

Followers

**FOLLOWER SET
SUT-47**

• Plug Follower Set:
SUT-0 (.395" / 10mm Diameter)
SUT-1 (.495" / 12.6mm Diameter)
SUT-3 (.500" / 12.7mm Diameter)
SUT-10 (.550" / 14mm Diameter).



**PLUG FOLLOWER
SUT-0**

• 0.395"
SUT-1
• 0.495"
SUT-3
• 0.500"



**FOLLOWER SET
SUT-14**

• Our Hollow Brass Follower Set contains 3 popular sizes of chrome plated, hollow brass followers.



**FLAT SPRING STEEL
FRS-4**

• Contains different sizes of the most popular flat and round spring steel
• Cut into convenient 9" (23cm) lengths



**FLAT SPRING STEEL
FRS-4**

• Contains different sizes of the most popular flat and round spring steel
• Cut into convenient 9" (23cm) lengths



Plug Holder

**VICE PLUG HOLDER
CPH-5**

• Holds the 5 most popular sizes:
.404" (10.26mm), .504" (12.80mm)
.508" (12.90mm), .512" (13.00mm)
.556" (14.12mm).

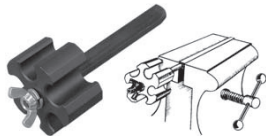

**CYLINDER HOLDER
CPH-9**

• Mounts on your work bench allowing you to choose from any one of these 5 popular sizes:
.404" (10.26mm), .504" (12.80mm)
.508" (12.90mm), .512" (13.00mm)
.556" (14.12mm)



**SOLID PLUG HOLDER
CPH-10**

• Made of hardened bar stock and holds many popular plugs; including: Arrow, Corbin, Kwikset, Lockwood, Sargent, Schlage, Weiser and Yale.



**CAP REMOVAL TOOL
SCRT-1**

• Removing a cylinder cap from Schlage "A" line locksets is a snap with this tool.

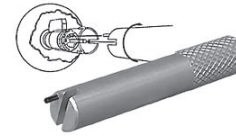

**KNOB REMOVER
KIKR-100**

Removes ball, tulip and standard style knobs for servicing without damaging the lockset! Perfect when picking is not an option! A must-have tool for all security professionals.

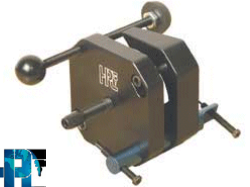

Removal Tools

**LEVER REMOVER
LHR-100**

• Remover is designed to quickly remove locked lever handles for servicing. It is ideal when picking the lock is not an option.

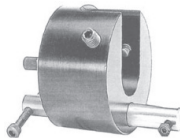

**LHR PARTS
LHR-HBOLT**

• Holding bolt
LHR-LSCREW
• Large depression screw
LHR-SSCREW
• Small depression screw



**LEVER WEDGE
LW-100**

Designed with two pivot points that allow you to spread a door from its frame and then, with a simple push, wedge it open!



**F SERIES KIT
FSR-100**

• Manipulate F series leversets through the opening in the back of the handle. The unique punch tool allows you to punch a small hole in the neck of the knob for quick access to the spindle, regardless of the handing of the door.

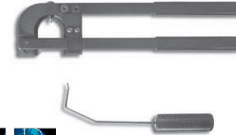

**F SERIES TOOLS
FSR-P100**

• F Series Pliers
FSR-T100
• F Series Manipulation Tool

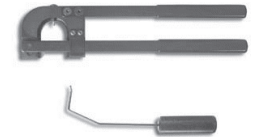

Car Tools

**AUTO CAP PLIERS
ALCP-10**

• Quickly remove auto face caps in seconds

ALCP-10
• Quickly remove auto face caps in seconds



**AUTO SLEEVE
AS-1**

• Prevent damage to weather stripping and automobile finish



**CLIP REMOVAL TOOL
AST-3**

• For Door Handle and Window Cranks
• Removes the hard to reach retaining clips without damage



**DOOR TRIM TOOL
AST-4**

• For door trim pads



**STARTER KILLER
AKK-55**

• The Starter Killer Kit (AKK-55) is ideal for beginners or locksmiths needing a small kit for a second service vehicle.



**PRO KILLER
AKK-66**

• This variety of tools will help you open an impressive amount of cars using the Through Car, Under Button, and Under & Over styles, as well as attacking vertical and horizontal rods, lazy pawls, bell cranks, and the GM latch.



**THRU CAR KILLER
AKK-TC**

• Contains everything you need to get inside the vehicle quickly and safely, without entering the door cavity.



**GOLD FINGER
AKK-GF**

• Includes: CO-90 Gold Finger, AW-99 Original HPC Air Wedge®, AS-1 AutoSleeve™.



**CLASSIC KILLER
AKK-88**

• Variety of tools will help you open most of the cars on the road today using the Through Vent, Through Lock, Through Handle, Through Car, Under Button, and Under & Over styles, as well as attacking vertical and horizontal rods, lazy pawls, bell cranks, and the GM latch.

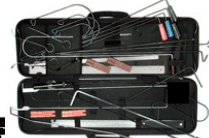

**ULTIMATE KILLER
AKK-99**

• First choice of locksmiths wanting to get into virtually every car on the road today! This is the ultimate set of tools for Lasso, Picking, Through Vent, Through Lock, Through Handle, Through Car, Under Button, and Under & Over styles of car opening.



<p>AUTO KILLER KIT AKK-P17</p>  <p>HPC</p>	<p>ORIGINAL SLIM JIM™ CO-10</p> <ul style="list-style-type: none"> • Been the entry tool by which all others have been judged since its introduction in 1967.  <p>HPC</p>	<p>THE SUPER JIM™ CO-11</p> <ul style="list-style-type: none"> • A wider version of the Original Slim Jim™ (CO-10) and on some models may be faster.  <p>HPC</p>	<p>THE BIG JIM™ CO-24</p> <ul style="list-style-type: none"> • The Big Jim™ is made especially for GM X-Type vehicles. Opens almost every vehicle that the Original Slim Jim™ • Size is 28.5" (72.5cm) long  <p>HPC</p>	<p>ORIGINAL KILLER CO-59</p> <ul style="list-style-type: none"> • This tool slides into the door cavity, under the window, up into the vehicle, and then bends over the door panel.  <p>HPC</p>
<p>THE COLLAPSIBLE OPENER CO-6</p> <ul style="list-style-type: none"> • Once the 3 segments are assembled, the tool totals 62" (157cm) in length and can reach across the car to unlock the opposite side door.  <p>HPC</p>	<p>THE CADDY KILLER CO-60</p> <ul style="list-style-type: none"> • Similar to the Original Killer (CO-59), but has increased height in the arc allowing you to enter vehicles where the window sits deeper inside the door.  <p>HPC</p>	<p>STRETCH KILLER™ CO-61</p> <ul style="list-style-type: none"> • Most universal dimensions of all of the Under & Over car opening tools. The height of the arc is greater than the Caddy Killer (CO-60), but the closed-hook end hangs lower, allowing you to reach locks that sit deeper in the door panel.  <p>HPC</p>	<p>OVER HOOK™ CO-68</p> <ul style="list-style-type: none"> • Designed to hook onto horizontal rods inside the car door, including some that might be located behind the window or other obstruction.  <p>HPC</p>	<p>SUPER KILLER™ CO-70</p> <ul style="list-style-type: none"> • Has extra length and great strength, can be used to open a wide variety of vehicles. This tool has the tallest and widest arc of all of the Under & Over tools, allowing it to get under the deepest window and around the widest door panels.  <p>HPC</p>
<p>STRECH DOUBLE L™ CO-71</p> <ul style="list-style-type: none"> • Upward hook on one leg and an outward hook on the opposite leg, they can easily grab and bind vertical linkages from above or below.  <p>HPC</p>	<p>SHORT DOUBLE L™ CO-72</p> <ul style="list-style-type: none"> • With an upward hook on one leg and an outward hook on the opposite leg, they can easily grab and bind vertical linkages from above or below.  <p>HPC</p>	<p>LASSO™ CO-73</p> <ul style="list-style-type: none"> • Vehicle entry when the lock button is visible. It is made of high quality "poly-flex" material with a waxed high-strength lanyard. The tool allows you to actually tie the string around the lock button and lift up to unlock the door.  <p>HPC</p>	<p>HORIZONTAL CO-75</p> <ul style="list-style-type: none"> • When the handles of this tool are separated, the hook at the end of the tool is pulled inward causing the tool to grip or bind the horizontal linkage rod.  <p>HPC</p>	<p>VERTICAL CO-76</p> <ul style="list-style-type: none"> • When the handles of this tool are separated, the hook at the end of the tool is pulled inward causing the tool to grip or bind the vertical linkage rod.  <p>HPC</p>
<p>5' SUPER SNARE™ CO-78</p> <ul style="list-style-type: none"> • Allows you to enter a vehicle and pull up buttons, grab keys, pull open levers, and much more! The CO-78 is a 5 foot long (150cm) metal tube with a wire inside that forms a loop on the end. To open the loop, slide the handles together. To close the loop, slide the handles apart.  <p>HPC</p>	<p>FISH HOOK™ CO-86</p> <ul style="list-style-type: none"> • For vehicle entry when the lock button is visible. Used with an HPC Wedge, the tool enters the auto interior, engages the button and with a simple twist, raises the button. This unique design features a long reach memory-flex rod for bending to the required shape.  <p>HPC</p>	<p>GOLD FINGER™ CO-90</p> <ul style="list-style-type: none"> • This 5-foot long bendable car opening tool has two special working ends. The hook end is designed to mimic your finger action pulling levers and flipping rockers. The opposing end is perfect for grabbing switches that must be pushed.  <p>HPC</p>	<p>AIR WEDGE AW-99</p> <ul style="list-style-type: none"> • Helps provide more than ample room to insert a car opening tool  <p>HPC</p>	<p>AIR WEDGE AW-99</p> <ul style="list-style-type: none"> • Helps provide more than ample room to insert a car opening tool  <p>HPC</p>
<p>AUTO WEDGES AW-34</p> <ul style="list-style-type: none"> • Size: 3/4" • 2/PK <p>AW-38</p> <ul style="list-style-type: none"> • Size: 3/8" • 2/PK  <p>HPC</p>	<p>POWER WEDGE™ PW-100</p>  <p>HPC</p>	<p>DOOR GUARD OVDG-11</p> <ul style="list-style-type: none"> • Offset: 1/4" <p>OVDG-12</p> <ul style="list-style-type: none"> • Offset: 3/8"  <p>HPC</p>	<p>GUARD PLATE VDG-10</p> <ul style="list-style-type: none"> • 14" long  <p>HPC</p>	<p>CYLINDER GUARD</p> <p>Hardened solid steel ring designed to guard against forcible entry. Spins freely around the cylinder, preventing the use of a wrench to break the cylinder.</p> <p>CG1-AXC</p> <ul style="list-style-type: none"> • Aluminum  <p>HPC</p>

Car Tools

Wedges

Door & Cylinder Guards

HPC Tools

Stamps & Dies

Key Tags & Rings

"FLIP IT" SPINNER

When picking a lock in the wrong direction the Flip-It™ will flip the cylinder plug past the upper pins and save you the job of re-picking. It also works equally well on disc tumbler locks
FIT-2



TORQUE & TENSION

TNT-2
• Regular House Cylinders, etc.



BACKSET MARKER

EBM-234
• The Easy Backset Marker marks backset location for 2 3/4" and 2 3/8" backset. It includes edge boremarks and is quick and easy to use!



FLEXI MAGNET

MAG-200
• This 5-foot flexible tool will wiggle and worm its way into the smallest of areas and attract your misplaced parts with its mighty double-sided magnetic force!



MULTI PURPOSE LIGHT

MPS-300
• Goosneck Worklight
• With Suction Cup



PROBE LIGHT 15"

FPL-15
• The body of this light is 15" (38cm) long, holds its shape, and comes with a plastic protective sheath.
• Requiring 3 AA batteries
FPL-B15
• Replacement bulb



PADLOCK SHIMS

PSA-20
• 20 piece Padlock Shim Pick Set is a fantastic alternative to picking, and in many situations is the only way to open a padlock in seconds
• Contains 5 of each of the 4 most common shackle diameters, which enables it to open a broad spectrum of locks.



STAMP ALIGNER™

SA-7
• Holds the stamps so that figures may be stamped on keys in a straight line with even spacing between characters. The Stamp Aligner™ has 7 detents to stamp up to 7 characters and 3 rows evenly on a standard key.



LOCKSMITH STAMP

LDNC
• "Do Not Copy"
LDND
• "Do Not Duplicate"



CYLINDER DIE

CLD-6
• Mortise Cylinder Die & Holder

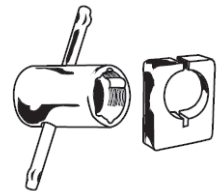

LOCK TAP & DIE SET

CLDT-5
• Complete Re-Tapping Kit with Cylinder Holding Fixture and Metal Box.

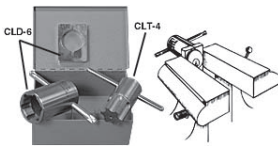

CLEAN GRIP TOOL

CGIT-10
• Clean grip impressing tool



KEY IMPRESSIONING

KFS-6
Files Included:
• Swiss Pattern Round-Tapered, 3 Square Tapered, Square-Tapered, Rectangular Straight, Warding Tapered, Half Round Tapered



PAPER TAG

Metal rim paper tag with string
100/BX
ERD-0
• Size: 1"
ERD-1
• Size: 1-3/16"
ERD-2
• Size: 1-1/2"
ERD-3
• Size: 1-13/16"



PAPER TAG

Metal rim paper tag with ring
100/BX
EYR-5
• Size: 1-1/4"
EYR-7
• Size: 1-3/4"



PAPER TAG

Metal rim paper tag with snap
100/BX
EYS-6
• Size: 1-1/4"
EYS-8
• Size: 1-3/4"



GIVEAWAY RING

GAK-4
• Size: 3/4"
• 1000/BX
GAK-6
• Size: 1"
• 1000/BX



LARGE KEY RING

LKR-11
• Size: 11"
LKR-6
• Size: 6"
LKR-8
• Size: 8"

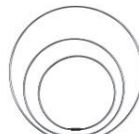

INVENTORY TAG

INV-1
• These tags offer a quick visual method of controlling key blank inventory.
• 100/BX

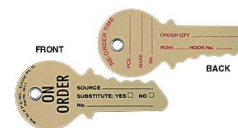

KEKAB OUT TAGS

OT-100
• 100/PK



KEKAB PLAIN TAGS

PLT-1
• 100/BX
PLT-20
• 20/PK



KEKAB # TAGS

20/PK
NT-1/20
• # 1-20
NT-21/40
• # 21-40
NT-41/60
• # 41-60
NT-61/80
• # 61-80
NT-81/100
• # 81-100



KEKAB # TAGS

20/PK
NT-101/120
• # 101-120
NT-121/140
• # 121-140
NT-141/160
• # 141-160
NT-161/180
• # 161-180



EMERGENCY BOX

511
• Size: 6.625" x 5.75" x 2"
• Key locking, plexiglass
• Comes with 5-wafer cam lock and attached hammer



511 REPLACEMENT

511-GLASS
• Replacement glass for 511



KEY CABINET

KEKAB-8

- Holds 8 Key Tags
- Size: 6.625" x 5.75" x 2"

KEKAB-30

- Holds 30 Key Tags
- Size: 12" x 8" x 2.5"

KEKAB-40

- Holds 40 Key Tags
- Size: 12" x 8" x 2.5"

KEKAB-60

- Holds 60 Key Tags
- Size: 17" x 13" x 3.25"

KEKAB-80

- Holds 80 Key Tags
- Size: 17" x 13" x 3.25"

KEKAB-120

- Holds 120 Key Tags
- Size: 17" x 13" x 3.25"

KEKAB-240

- Holds 240 Key Tags
- Size: 20" x 16.5" x 5"

KEKAB-330

- Holds 330 Key Tags
- Size: 20" x 16.5" x 5"

KEKAB-500

- Holds 500 Key Tags
- Size: 25.25" x 18" x 5.5"



KEKAB TWO-TAG

The Two-Tag System enables you to loan a key, while keeping a copy in the cabinet for emergency use.

KEKAB-T30

- Holds 30 Key Tags
- Size: 12" x 8" x 2.5"

KEKAB-T60

- Holds 60 Key Tags
- Size: 17" x 13" x 3.25"

KEKAB-T240

- Holds 240 Key Tags
- Size: 20" x 16.5" x 5"



SLIMKAB

SK-15X

- 15 key capacity (expandable to 25)

SK-20X

- 20 key capacity (expandable to 35)

SK-25

- 25 key capacity



KEKAB CARRY CASE

KEKAB-C40

- Holds 8 Key Tags
- Size: 6.625" x 5.75" x 2"

KEKAB-C80

- Holds 30 Key Tags
- Size: 12" x 8" x 2.5"



KEKAB MORTISE

Uses 1" mortise cylinders with an Adams Rite cam. Comes less Mortise Cylinder.

KEKAB-KK65

- Holds 65 Key Tags
- Size: 17" x 13" x 3.25"

KEKAB-KK265

- Holds 265 Key Tags
- Size: 20" x 16.5" x 5"



NO.101 KEY TAG

Size: 15/16" x 2-1/4"
10100
 • 100/BX
10102
 • 2/CD
10124
 • 24/CD



NO.123 KEY TAG

• Size: 15/16" x 2-1/4"
12300
 • 100/BX
1230010
 • 2/CD
12302
 • 24/CD



NO.162 HOUSE CAPS

• Size: 1-1/4" x 1"
16200
 • 100/BX
16202
 • 2/CD Neon
16206
 • 24/CD
16207
 • 100/BX Neon
16225
 • 100/Jar
16226
 • 100/Jar Neon



NO.165 KEY CAPS

• Size: 1-1/4" x 1"
16500
 • 200/BX
16504
 • 4/CD
16507
 • 200/BX Fluorescent
16520
 • 50/PK Black
16525
 • 200/Jar
16530
 • 50/PK Blue

16533
 • 400/BX
16534
 • 400/BX Neon Ass't
16535
 • 50/PK Dark Blue
16540
 • 50/PK Green
16570
 • 70/PK Red
16580
 • 50/PK Yellow



NO.164 SMALL

Diameter: 13/16"
16400
 • 200/BX
16425
 • 200/Jar



NO.166 LARGE

Diameter: 1-3/16"
16603
 • 3/CD
16615
 • 150/BX
16620
 • 50/PK Black
16625
 • 150/Jar
16630
 • 50/PK Blue
16640
 • 50/PK Green
16665
 • 50/PK Dark Purple
16670
 • 50/PK Red
16680
 • 50/PK Yellow



NO.167 MEDIUM

Diameter: 1"
16700
 • 200/BX
16704
 • 4/CD
16707
 • 200/BX
16720
 • 50/PK Black
16725
 • 200/Jar
16730
 • 50/PK Blue
16733
 • 400/BX
16734
 • 400/BX Neon



NO.167 MEDIUM

Medium Refill 50/PK
16740
 • Green
16746
 • FL Green
16756
 • FL Orange
16765
 • Dark Purple
16766
 • FL Pink
16770
 • Red
16780
 • Yellow
16786
 • FL Yellow



NO.168 KEY TAG

Flexible Tag with Swivel Ring
 Size: 7/8" x 2"
16800
 • 200/BX Display
16802
 • 2/CD



NO.169 KEY TAG

Key Tag with Ring
 Size: 7/8" x 2"
16900
 • 200/BX Display
16920
 • 50/PK Black
16930
 • 50/PK Blue
16940
 • 50/PK Green
16965
 • 50/PK Dark Purple
16970
 • 50/PK Red
16980
 • 50/PK Yellow



NO.201

Key tag with ball chain
 Size: 1-1/8" x 2-1/4"
20100
 • 100/BX
20102
 • 2/CD



NO.204

Key tag with split ring
 Size: 1-1/8" x 2-1/4"
20400
 • 100/BX



BINDER RING

Diameter: 1"
24302
 • 2/CD



NO.281 LABEL-IT

Diameter: 1-1/4"
28129
 • 25/CLM
28329
 • 25/CLM White



NO.250 & 251

Plastic Tag
 Diameter: 1-1/4", Ring Diameter: 3/4"
25029
 • 25/CLM
25129
 • 25/CLM White



NO.256

Aluminum Tags
 Diameter: 1-1/4"
25630
 • 100/BX Blue
25665
 • 100/BX Purple
25670
 • 100/BX Red
25693
 • 100/BX Aluminum



ACRYLIC

Size: 1-3/4" x 2-1/4"
20601
 • 1/CD



COLOR PAPER TAGS

• Size: 1-1/4"
28529
 • 25/CLM



GRAPHITE

• Size: 3.25 grams
95001
 • 1/CD



CABINET TAGS

Tag with labels
 Diameter: 1-1/2", 20/PK
2660020
 • Assorted
2663020
 • Blue
2664020
 • Green
2667020
 • Red
2668020
 • Yellow
2669020
 • White



NO.280 METAL RIM

28000
 • Diameter: 15/16"
 • 50/BX
28200
 • Diameter: 1-1/4"
 • 50/BX
28229
 • Diameter: 1-1/4"
 • 25/CLM
28400
 • Diameter: 1-9/16"
 • 50/BX



BALL CHAIN

• Size: 4-1/2"
31402
 • 2/CD
31424
 • 24/CD



NECK CHAIN













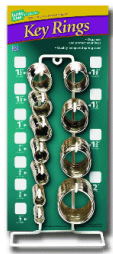











• Size: 24"
31601
 • 1/CD



100' BALL CHAIN

31700
 • No.6 Nickel Plated
31800
 • No. 6 Yellow Brass



<p>CONNECTORS</p> <ul style="list-style-type: none"> • 100/PK • 31900 • Nickel Plated • 32000 • Brass  <p>Lucky Line Products</p>	<p>NO.#260 BRASS TAGS</p> <p>26006 • Size: 3/4"</p> <p>26010 • Size: 1"</p> <p>2601010 • Size: 1"</p> <p>26011 • Size: 1-1/8"</p> <p>26012 • Size: 1-1/4"</p> <p>2601220 • Size: 1-1/4"</p> <p>26013 • Size: 1-3/8"</p> <p>2601310 • Size: 1-3/8"</p> <p>26017 • Size: 1-7/8"</p> <p>26512 • Size: 1-1/4"</p> <p>2601220 • Size: 1-1/4"</p> <p>26013 • Size: 1-3/8"</p> <p>2601310 • Size: 1-3/8"</p>  <p>Lucky Line Products</p>	<p>SPLIT KEY RING</p> <p>36500</p> <ul style="list-style-type: none"> • Holds 365 key rings in 11 different sizes • Split key rings supplied from 1/2" to 2" • Sits on counter, hangs on pegboard or slat wall • Size: 6" x 13" x 6"  <p>Lucky Line Products</p>	<p>POCKET CHAIN</p> <p>Size: 18"</p> <p>40101 • 1/CD</p> <p>40106 • 6/CD</p>  <p>Lucky Line Products</p>	
<p>POCKET CHAIN</p> <p>• Size: 6-1/2"</p> <p>40301 • 1/CD</p>  <p>Lucky Line Products</p>	<p>SECURE-A-KEY CLIP</p> <p>Size: 2" (without split ring), Clip-On</p> <p>40401 • 1/CD</p> <p>40412 • 12/CD</p>  <p>Lucky Line Products</p>	<p>SECURE-A-KEY SLIP</p> <p>Size: 2" (without split ring), Slip-On</p> <p>40501 • 1/CD</p> <p>40512 • 12/CD</p>  <p>Lucky Line Products</p>	<p>BELT HOOK</p> <p>• Size: 2-7/8" (without split ring)</p> <p>40601 • 1/CD</p> <p>40612 • 12/CD</p>  <p>Lucky Line Products</p>	<p>WRIST COIL</p> <p>• Size: 2" (stretches to 12")</p> <p>41001 • 1/CD</p> <p>41006 • 1/CD Neon</p> <p>41012 • 12/CD</p> <p>41025 • 25/JAR</p>  <p>Lucky Line Products</p>
<p>NYLON KEY GAURD</p> <p>41101 • 1/CD</p> <ul style="list-style-type: none"> • J-Clip • Size: 4-3/4" • 41201 • 12/CD • Split Ring • Size: 3-3/4"  <p>Lucky Line Products</p>	<p>TRIGGER SNAP COIL</p> <p>Size: 4" (stretches to 36")</p> <p>41301 • 1/CD</p> <p>41312 • 12/CD</p> <p>41325 • 20/JAR</p>  <p>Lucky Line Products</p>	<p>LANYARD</p> <p>Size: 21-1/2"</p> <p>41401 • 1/CD</p> <p>41412 • 12/CD</p> <p>41420 • 10/PK Black</p> <p>41427 • 60/JAR</p>  <p>Lucky Line Products</p>	<p>SNAP CLIP</p> <p>• Size: 3-1/2" (without split ring)</p> <p>41501 • 1/CD</p> <p>41536 • 36/CD</p>  <p>Lucky Line Products</p>	<p>DESIGNER KEY COIL</p> <p>• Size: 3-1/2" (without split ring)</p> <p>41601 • 1/CD</p> <p>41612 • 12/CD</p> <p>41620 • 10/PK Black</p> <p>41631 • 10/PK Bright Blue</p>  <p>Lucky Line Products</p>
<p>NYLON KEY GAURD</p> <p>Size: 6" (without split ring) Adjusts to 7-1/2"</p> <p>41801 • 1/CD</p>  <p>Lucky Line Products</p>	<p>WHISTLE</p> <p>Size: 2"</p> <p>42101 • 1/CD</p> <p>42201 • 1/CD w/ Lanyard</p> <p>42301 • 1/CD w/ Coil</p>  <p>Lucky Line Products</p>	<p>KEY REEL</p> <p>Size: 2" with 24" Cable Clips onto belt</p> <p>42501 • 1/CD</p>  <p>Lucky Line Products</p>	<p>KEY RELEASE</p> <p>• Size: 3/4" with 24" Cable</p> <p>• 5 removable 1/2" tempered steel key rings</p> <p>42701 • 1/CD</p>  <p>Lucky Line Products</p>	<p>MINI BAK</p> <p>• Size: 1" with 3" extension</p> <p>42801 • 1/CD Clip-On</p> <p>42901 • 1/CD Pin-On</p> <ul style="list-style-type: none"> • Come with badge holder • 43801 • 1/CD Clip-On • Come with split ring  <p>Lucky Line Products</p>
<p>MITY-MITE</p> <p>43000 • 100/BX</p> <ul style="list-style-type: none"> • Diameter: 5/16"  <p>Lucky Line Products</p>	<p>MITY-MITE</p> <p>43100 • 100'</p>  <p>Lucky Line Products</p>	<p>MITY-MITE CHAIN</p> <p>Size: 5-3/8"</p> <p>43201 • 1/CD</p> <p>43224 • 24/CD</p>  <p>Lucky Line Products</p>	<p>KEY-BAK SLIP ON</p> <p>Diameter: 2-1/2" with 24" chain, Fits up to 2" width belt.</p> <p>43301 • 1/CD Chrome</p> <p>43401 • 1/CD Black</p>  <p>Lucky Line Products</p>	<p>KEY-BAK CLIP ON</p> <p>Diameter: 2-1/2" with 24" chain</p> <p>43501 • 1/CD Chrome</p> <p>43601 • 1/CD Black</p>  <p>Lucky Line Products</p>

KEY-BAK KEVLAR

Size: 2-1/2" with 48" pull
43451
 • 1/CD



SUPER 48 KEY-BAK

Size: 2-1/2" with 48" pull, Clip On
43651
 • 1/CD



KEY-BAK KEVLAR

Size: 2-1/2" with 48" pull, Clip-On
43751
 • 1/CD
 • Chrome



TRIGGER SNAP

44001
 • Size: 2-5/8" (without split ring)
 • 1/CD Brass
44101
 • Size: 2-1/2" (without split ring)
 • 1/CD Nickel Plated



SMALL TRIGGER

44301
 • Size: 1-1/2" (without split ring)
 • 1/CD Nickel Plated

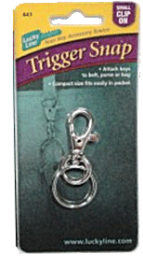

LEATHER CLIP

Size: 6", Belt Clip
45201
 • 1/CD w/ Bolt Snap
45210
 • 10/CD w/ Bolt Snap
45301
 • 1/CD w/ Snap



QUICK CLIP

Size: 2-5/8"
45801
 • 1/CD
45824
 • 14/CD
45825
 • 25/JAR



SMALL C-CLIP

Size: 2-3/8" (without split ring)
46001
 • 1/CD
46020
 • 10/PK Black
46027
 • 75/JAR
46030
 • 10/PK Blue
46040
 • 10/PK Green
46065
 • 10/PK Purple
46070
 • 10/PK Red
46075
 • 50/PK
46093
 • 10/PK Silver



LARGE C-CLIP

Size: 3-1/8" (without split ring)
46101
 • 1/CD
46112
 • 12/CD
46120
 • 10/PK Black
46127
 • 50/JAR
46130
 • 10/PK Blue
46140
 • 10/PK Green
46165
 • 10/PK Purple
46170
 • 10/PK Red
46175
 • 20/PK
46193
 • 10/PK Silver



GEAR KEEPER

47101
 • Size: 1-1/2" x 3" (without split ring)
 • Low Force 1-7 keys
47201
 • Size: 1-1/2" x 3" (without split ring)
 • Medium Force 7-14 keys
47301
 • Size: 2" x 4" (without split ring)
 • High Force 15+



KEY SAFE

Size: 2" (without split ring)
47601
 • 1/CD
47612
 • 12/CD



REMOTE SKINS

Size: 2" (without split ring)
48800
 • 12/BX Display
48801
 • 1/BX Ford
48901
 • 1/BX GM
49001
 • 1/BX Universal (Most Honda & Toyota)



RESTROOM TAG

Size: 3-1/2" x 4-1/2"
53000
 • 10/PK Womens
53100
 • 10/PK Mens



HINGED KEY TAG

Size: 1-1/8" x 2-1/4"
60500
 • 100/BX
60502
 • 2/CD



4-KEY TAG RACK

60540
 • Size: 5" x 2-1/2" x 1/2"
 • 4 Key Rack
 • Easy to install, includes adhesive tape



6-KEY TAG RACK

6 Key Rack. Easy to install, includes adhesive tape. Size: 5" x 2-1/2" x 1/2"
60560
 • White
60562
 • Charcoal



8-KEY TAG RACK

60580
 • Size: 10" x 2-1/2" x 1/2"
 • 8 Key Rack
 • Easy to install, includes adhesive tape



WAVY KEY RACK

Size: 10-1/4" x 3-1/4" x 5/8"
60700
 • 1/CD



PLASTIC KEKAB

Has 24 numbered hooks.
 Size: 8-1/2" x 10-1/2" x 1-3/4"
61000
 • No Lock
61200
 • Supplied with 2 keys; Use Elgin 21 key blank



KEY CASE 6 HOOKS

61500
 • Size: 9" x 6" x 1-3/4"
 • White



KEY PORTFOLIO

Store up to 12 key saver cards, or 24 keys. Size: 8-1/2" x 10-1/2" x 1-3/4"
62000
 • Includes 12 No. 916 key savers for 2 standard keys
62100
 • Includes 12 No. 917 key savers for 1 standard & 1 large headed key



LUGGAGE TAG

• Size: 2-1/4" x 3-1/2"
63101
 • 1/CD



LED LIGHT

• Size: 2-5/8"
63701
 • 1/CD



TURN & SPRING

Size: 3-1/4" x 2"
70200
 • 100/BX Turn Sleeve
70401
 • 1/CD Spring Sleeve
70424
 • 24/CD Spring Sleeve



<p>QUICK RELEASE</p> <ul style="list-style-type: none"> • Size: 3" 70701 • 1/CD 70712 • 12/CD 70725 • 75/JAR  <p>Lucky Line Products</p>	<p>KEY SEPARATOR</p> <p>Size: 3-1/2"</p> <ul style="list-style-type: none"> 70801 • 1/CD 70825 • 50/JAR  <p>Lucky Line Products</p>	<p>FLEX-O-LOC</p> <p>Size: 5"</p> <ul style="list-style-type: none"> 71101 • 1/CD  <p>Lucky Line Products</p>	<p>KEY SAVER</p> <p>1 standard & 1 large headed key</p> <ul style="list-style-type: none"> 91701 • 1/CD  <p>Lucky Line Products</p>	<p>3-WAY PULL APART</p> <ul style="list-style-type: none"> • Size: 3" 91701 • 1/CD 71712 • 12/CD  <p>Lucky Line Products</p>
<p>OVAL KEY RING</p> <ul style="list-style-type: none"> • Size: 2-3/8" 73701 • 1/CD 73725 • 100/JAR  <p>Lucky Line Products</p>	<p>PULL APART RING</p> <ul style="list-style-type: none"> 74300 • Size: 6-1/2" • 25/BX 74400 • Size: 4-3/4" • 25/BX 74600 • Size: 6" • 25/BX  <p>Lucky Line Products</p>	<p>TANG RING</p> <p>Diameter: 1"</p> <ul style="list-style-type: none"> 75202 • 2/CD  <p>Lucky Line Products</p>	<p>SPRINKLER HIDER</p> <p>Size: 2" x 3-3/4"</p> <ul style="list-style-type: none"> 91901 • 1/CD 91961 • 1/BX Display  <p>Lucky Line Products</p>	<p>SPLIT KEY RING</p> <p>2/CD, Nickel Plated</p> <ul style="list-style-type: none"> 76002 • Size: 1/2" 76102 • Size: 5/8" 76302 • Size: 7/8" 76502 • Size: 1-1/8" 76602 • Size: 1-1/4" 77001 • Size: 2" (1/CD)  <p>Lucky Line Products</p>
<p>SPLIT KEY RING</p> <p>100/BX, Nickel Plated</p> <ul style="list-style-type: none"> 76000 • Size: 1/2" 76100 • Size: 5/8" 76200 • Size: 3/4" 76300 • Size: 7/8" 76400 • Size: 1" 76500 • Size: 1-1/8" <ul style="list-style-type: none"> 76600 • Size: 1-1/4" 76700 • Size: 1-3/8" 76800 • Size: 1-1/2" (50/BX) 76900 • Size: 1-3/4" (50/BX) 77000 • Size: 2" (50/BX) 79100 • Size: 2" (25/BX)  <p>Lucky Line Products</p>	<p>BRASS SPLIT RING</p> <p>100/BX, Brass Plated</p> <ul style="list-style-type: none"> 77300 • Size: 7/8" 77400 • Size: 1" 77500 • Size: 1-1/8" 77600 • Size: 1-1/4"  <p>Lucky Line Products</p>	<p>SOLID BRASS</p> <ul style="list-style-type: none"> • Size: 7/8" • Solid brass split ring 80300 • 100/BX  <p>Lucky Line Products</p>	<p>COLOR SPLIT RING</p> <ul style="list-style-type: none"> • Size: 1" 79401 • 1/CD 79425 • 200/JAR  <p>Lucky Line Products</p>	
<p>LOCKING CABLE</p> <ul style="list-style-type: none"> • Size: 4-1/2" 80820 • 25/PK Black 80830 • 25/PK Blue 80870 • 25/PK Red  <p>Lucky Line Products</p>	<p>TWISTY KEY RING</p> <ul style="list-style-type: none"> 81101 • 1/CD Nylon 81124 • 24/CD Nylon • Size: 5" 82901 • 1/CD Brass Plated • Size: 9" 84101 • 1/CD Stainless Steel • Size: 5"  <p>Lucky Line Products</p>	<p>SKELETON KEY</p> <p>Flat and Notch Tip</p> <ul style="list-style-type: none"> 87202 • 2/CD  <p>Lucky Line Products</p>	<p>BOTTLE OPENER</p> <p>Comes with key ring</p> <p>Size: 2-1/4"</p> <ul style="list-style-type: none"> 87701 • 1/CD 87720 • 20/PK  <p>Lucky Line Products</p>	<p>WALLET KEY HIDER</p> <p>Size: 3-3/8" x 2-1/8"</p> <ul style="list-style-type: none"> 90901 • 1/CD  <p>Lucky Line Products</p>
<p>COIN HOLDER</p> <p>Size: 2" x 3"</p> <ul style="list-style-type: none"> 94101 • 1/CD  <p>Lucky Line Products</p>	<p>COLLAPSE-A-CONE</p> <p>Size: 9-1/2" (base) 18" (expanded height)</p> <ul style="list-style-type: none"> 87800 • 1/Zipper Case • LED Light 87900 • 1/Polybag • Non-LED Light  <p>Lucky Line Products</p>	<p>CRIMPING TOOL</p> <p>Size: 1" with 3" extension</p> <ul style="list-style-type: none"> 88000 • 1/CD  <p>Lucky Line Products</p>	<p>ROCK KEY HIDER</p> <p>Size: 4"</p> <ul style="list-style-type: none"> 90601 • 1/CD 90661 • 24/Counter Display  <p>Lucky Line Products</p>	<p>THUMBLITES</p> <ul style="list-style-type: none"> 90700 • 25/BX 90701 • 1/CD  <p>Lucky Line Products</p>

KEY HIDER

Magnetic Case
 Large: 3" x 1-7/8" x 5/8"
91001
 • 1/CD
91010
 • 10/Magnetic Display
91012
 • 12/BX Display



KEY HIDER

Magnetic Case
 Extra Large: 3-7/8" x 2-1/8" x 5/8"
91200
 • 6/BX Display
91201
 • 1/CD
91210
 • 10/CD



VELCRO KEY HIDER

Large: 2" x 4"
91401
 • 1/CD
91410
 • 10/CD

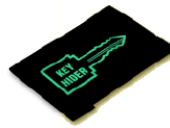

VELCRO KEY HIDER

Extra Large: 2-3/4" x 4"
91301
 • 1/CD

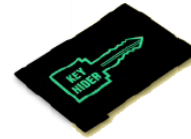

KEY FLOAT W/ CHAIN

Size: 3-1/2" x 1-3/8" x 1"
92401
 • 1/CD Orange
92412
 • 12/CD Orange
92801
 • 1/CD Yellow
92812
 • 12/CD Yellow
92912
 • 12/CD Assorted



ZIPPER KEY CASE

93601
 • 1/CD 6 Hook
 • Size: 2-1/2" x 3-1/2"
93901
 • 1/CD 12 Hook
 • Size: 2-3/4" x 4"



KEY LIGHT

• Size: 2" x 1-1/4"
90801
 • 1/CD



SMALL BOLT SNAP

Size: 2-1/8" (without split ring)
 Nickel Plated
44501
 • 1/CD
44524
 • 24/CD



BRASS BOLT SNAP

45001
 • Size: 3" (without split ring)
 • Solid Brass
 • 1/CD



BOLT SNAP

Size: 3-1/8" (without split ring)
 Nickel Plated
45101
 • 1/CD
45112
 • 12/CD



DOUBLE ENDED

Size: 3-1/2" (without split ring)
 Nickel Plated
44912
 • 12/CD
44975
 • 30/PKG



DOUBLE ENDED

44701
 • Size: 3-1/4" (without split ring)
 • 1/CD
 • Nickel Plated



DOUBLE ENDED

44801
 • Size: 3-1/8" (without split ring)
 • 1/CD
 • Solid Brass



AMERICAN FLAG

5/BX
B101K
 • Kwickset
B101S
 • Schlage



DIAMOND

5/BX
B102K
 • Kwickset
B102S
 • Schlage



MONEY

5/BX
B103K
 • Kwickset
B103S
 • Schlage



PEACE SIGN

5/BX
B104K
 • Kwickset
B104S
 • Schlage



HOME

5/BX
B105K
 • Kwickset
B105S
 • Schlage



FLOWER

5/BX
B106K
 • Kwickset
B106S
 • Schlage



ROSE

5/BX
B107K
 • Kwickset
B107S
 • Schlage



RED WINE

5/BX
B108K
 • Kwickset
B108S
 • Schlage



MARGARITA

5/BX
B109K
 • Kwickset
B109S
 • Schlage



BEER MUG

5/BX
B110K
 • Kwickset
B110S
 • Schlage



ICE CREAM

5/BX
B111K
 • Kwickset
B111S
 • Schlage



PALM TREE

5/BX
B112K
 • Kwickset
B112S
 • Schlage



<p>BEACH 5/BX B113K • Kwickset B113S • Schlage</p>  <p>Lucky Line Products</p>	<p>DOG 5/BX B114K • Kwickset B114S • Schlage</p>  <p>Lucky Line Products</p>	<p>CAT 5/BX B115K • Kwickset B115S • Schlage</p>  <p>Lucky Line Products</p>	<p>CHECKERED FLAG 5/BX B116K • Kwickset B116S • Schlage</p>  <p>Lucky Line Products</p>	<p>FISHING 5/BX B117K • Kwickset B117S • Schlage</p>  <p>Lucky Line Products</p>
<p>RIFLE 5/BX B118K • Kwickset B118S • Schlage</p>  <p>Lucky Line Products</p>	<p>GOLF 5/BX B119K • Kwickset B119S • Schlage</p>  <p>Lucky Line Products</p>	<p>BASEBALL 5/BX B120K • Kwickset B120S • Schlage</p>  <p>Lucky Line Products</p>	<p>FOOTBALL 5/BX B121K • Kwickset B121S • Schlage</p>  <p>Lucky Line Products</p>	<p>HAMMER 5/BX B122K • Kwickset B122S • Schlage</p>  <p>Lucky Line Products</p>
<p>WRENCH 5/BX B123K • Kwickset B123S • Schlage</p>  <p>Lucky Line Products</p>	<p>CROSS 5/BX B124K • Kwickset B124S • Schlage</p>  <p>Lucky Line Products</p>	<p>MUSIC 5/BX B125K • Kwickset B125S • Schlage</p>  <p>Lucky Line Products</p>	<p>TAPE MEASURE 5/BX B126K • Kwickset B126S • Schlage</p>  <p>Lucky Line Products</p>	<p>EARTH 5/BX B127K • Kwickset B127S • Schlage</p>  <p>Lucky Line Products</p>



Lucky Line creates innovated solutions for key handling and key organization.
Buy now at R&H Wholesale!

Cams Locks

PIN TUMBLER
DCN1-26D
• KD, KA103
• Cylinder Length: 1-1/16"
• Max Thickness: 3/4"
• D4291 KWY



PIN TUMBLER
DCN2-26D
• KD, KA103
• Cylinder Length: 1-3/16"
• Max Thickness: 7/8"
• D4291 KWY



PIN TUMBLER
DCN3-26D
• KD, KA103
• Cylinder Length: 1-7/16"
• Max Thickness: 1-1/8"
• D4291 KWY



PIN TUMBLER
DCN4-26D
• KD, KA103
• Cylinder Length: 1-3/4"
• Max Thickness: 1-1/2"
• D4291 KWY



DISC TUMBLER
C8051-14A
• KD, C415A
• Cylinder Length: 7/16"
• Max Thickness: 7/64"
• D8785 KWY



DISC TUMBLER
C8052-14A
• KD, C346A, C390A, C415A, C420A
• Cylinder Length: 5/8"
• Max Thickness: 15/64"
• D8785 KWY



DISC TUMBLER
C8054-14A
• KD, C415A
• Cylinder Length: 15/16"
• Max Thickness: 5/8"
• D8785 KWY



DISC TUMBLER
C8060-14A
• KD, C415A
• Cylinder Length: 1-3/4"
• Max Thickness: 1-7/16"
• D8785 KWY



DISC TUMBLER
C8073-14A
• KD, C415A
• Cylinder Length: 1-3/4"
• Max Thickness: 1-7/16"
• D8785 KWY
C8073-3
• C415A



DISC TUMBLER
C8075-14A
• KD, C415A
• Cylinder Length: 1-7/16"
• Max Thickness: 1-1/8"
• D8785 KWY
C8075-3
• C415A



COMBINATION
D8030-19
• KD, DA120
• Cylinder Length: 7/8"
• Max Thickness: 5/8"
• D8770 KWY



COMBINATION
D8031-19
• KD, DA120
• Cylinder Length: 1-3/8"
• Max Thickness: 1-1/8"
• D8870 KWY



PIN TUMBLER CAM LOCKS

KD, KA103 - D4291 KWY
C8101-26D
• Cylinder Length: 15/16"
• Max Thickness: 5/8"
C8102-26D
• Cylinder Length: 1-1/16"
• Max Thickness: 3/4"
C8103-26D
• Cylinder Length: 1-3/16"
• Max Thickness: 7/8"
C8106-26D
• Cylinder Length: 1-7/16"
• Max Thickness: 1-1/8"
C8108-26D
• Cylinder Length: 1-3/4"
• Max Thickness: 1-3/8"
C8109-26D
• Cylinder Length: 1-3/4"
• Max Thickness: 1-1/2"



TUBULAR CAM LOCKS

KD, KA - K137 KWY
MFW1038
• "A" Dimension: 1/2"
MFW1058
• "A" Dimension: 23/32"
MFW1078
• "A" Dimension: 15/16"
MFW1118
• "A" Dimension: 1-5/32"
MFW1148
• "A" Dimension: 1-1/2"

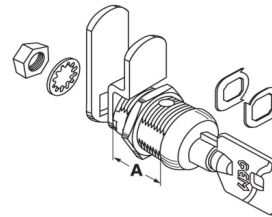

23000 & 24000 SERIES CAM LOCKS

Single Bitted, Universal Keyway
KA - 54G KWY
MFW23038
• "A" Dimension: 7/16"
MFW23058
• "A" Dimension: 5/8"
MFW23078
• "A" Dimension: 7/8"
MFW23118
• "A" Dimension: 1-1/8"
MFW23138
• "A" Dimension: 1-3/8"
MFW23168
• "A" Dimension: 1-3/4"

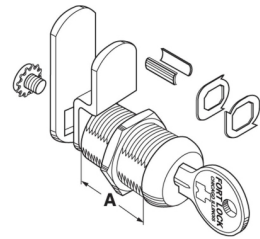

Single Bitted, Universal Keyway
KA - OOV KWY
MFW24038
• "A" Dimension: 7/16"
MFW24058
• "A" Dimension: 5/8"
MFW24118
• "A" Dimension: 1-1/8"

File Cabinet Locks & Bars

FILE BAR
FB
• File Cabinet Bar
• Available in:
1 Drawer
2 Drawer
3 Drawer
4 Drawer
5 Drawer



FILE BAR
ML
• File Cabinet Bar
• Available in:
1 Drawer
2 Drawer
3 Drawer
4 Drawer
5 Drawer

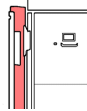

FILE BAR
FG12B
• 2 Drawer
FG14B
• 4 Drawer
FG15B
• 5 Drawer
• Black



PIN TUMBLER
Cabinet lock
5001LP
• "Q.A" Dimension: 1-3/4"
• KD, KA1X20, KA2X02, KA3X5
• DK-P-1 KWY



PIN TUMBLER
Cabinet lock
5002LP
• "Q.A" Dimension: 2"
• KD, KA1X20, KA2X02, KA3X5
• DK-P-1 KWY



PIN TUMBLER
Cabinet lock
CEPX-19DC
• "Q.A" Dimension: 1-33/64"
• KD, KA5X75
• DK-P-2 KWY



PLUG
Steelcase Plug
P1076-K101
P1076-K102
P1076-K103
P1076-K104
• KD



DISC TUMBLER
Cabinet Lock, Spring
C8047-26
• KD, KAP141A
• D8776 KWY



PIN TUMBLER
File Cabinet, Spring
C8150-26
• KD, KA103
• D4291 KWY



PIN TUMBLER
File Cabinet, Rekeyable
FC10-26D
• KA915
• D4291 KWY



FILE CABINET
2162
• KD, KAK21
• For HOLGA File Cabinet

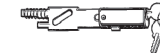

FILE CABINET
2176
• KD
• For GLOBAL File Cabinet



HON KIT F24/F28
2185
• KD, KA7, KA9
• Kit for HON file cabinets F24 & F28 style



HON KIT
2188
• KA9
• Hon Lateral Lock Kit



HON KIT F26
2190
• KD, KA1
• Kit for HON file cabinet F26



HON KIT
2194
• KD
• For Anderson Hickey 15400



SINGLE BITTED
MFWSG23000
• KD, KA217, KA221
• 2 One-Way Bars, Wood & Glass
• Removable Cylinder for rekeying
• Anti-Spread Housing

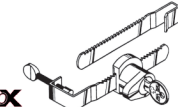

DOUBLE BITTED
MFWSG29000
• KD, KA3012, KA3045, KA3059, KA3085
• 2 One-Way Bars, Wood & Glass
• Removable Cylinder for rekeying
• Anti-Spread Housing

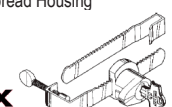



















































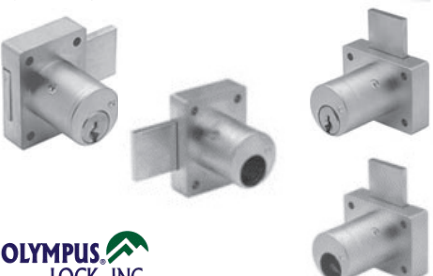

Showcase Locks

<p>SHOWCASE LOCK 15RL-KD or KA • Wood or Glass 7RL-KD • Wood 8RL-KD • Glass</p>  	<p>PIN TUMBLER Left Locking Cam Position C8710 • Replaces Bommer • 90° c/cw to open • D4291 KWY</p>  	<p>PIN TUMBLER Upward Locking Cam Position C8711 • Replaces Bommer • 90° c/cw to open • D4291 KWY</p>  	<p>PIN TUMBLER Downward Locking Cam Position C8712 • Replaces Bommer • 90° c/cw to open • D4291 KWY</p>  	<p>PIN TUMBLER Left Locking Cam Position C8713 • Replaces Auth Electric & Bommer • 90° c/cw to open • D4291 KWY</p>  	<p>PIN TUMBLER Left Locking Cam Position C8714 • Replaces American Device • 90° c/cw to open • D4291 KWY</p>  
<p>PIN TUMBLER Upward Locking Cam Position C8715 • Replaces Florence Mfg. • 90° c/cw to open • D4291 KWY</p>  	<p>PIN TUMBLER Upward Locking Cam Position C8716 • Replaces S.H. Couch • 90° cw to open • D4291 KWY</p>  	<p>PIN TUMBLER Left Locking Cam Position C8717 • Replaces Nutone • 90° c/cw to open • D4291 KWY</p>  	<p>PIN TUMBLER Left Locking Cam Position C8718 • Replaces Cultter Mail Chute • 90° c/cw to open • D4291 KWY</p>  	<p>PIN TUMBLER Upward Locking Cam Position C8719 • Replaces Miami-Carey • 90° c/cw to open • D4291 KWY</p>  	<p>PIN TUMBLER Downward Locking Cam Position C8720 • Replaces Dura Steel • 90° cw to open • D4291 KWY</p>  
<p>PIN TUMBLER Left Locking Cam Position C8721 • Replaces Permabit - XL-201 • 90° c/cw to open • D4291 KWY</p>  	<p>PIN TUMBLER MAIL BOX LOCK Universal Mail Box Front C8730 • 5 cams, 2 keys, mount nut, mount clip and cam screw • 90° c/cw to open • D4291 KWY</p>  		<p>PIN TUMBLER MAIL BOX LOCK Door & Pedestal Mounted Boxes C8735 • 5 cams, 2 keys, mount nut, mount clip and cam screw • 90° cw to open • D4291 KWY</p>  		<p>PIN TUMBLER Left Locking Cam Position C8723 • Replaces Jensen General • 90° c/cw to open • D4291 KWY</p>  
<p>PIN TUMBLER Downward Locking Cam Position C8722 • Replaces Dura Steel - XL-202 • 90° cw to open • D4291 KWY</p>  	<p>PIN TUMBLER MAIL BOX LOCK Universal Mail Box Front C8730 • 5 cams, 2 keys, mount nut, mount clip and cam screw • 90° c/cw to open • D4291 KWY</p>  		<p>PIN TUMBLER MAIL BOX LOCK Door & Pedestal Mounted Boxes C8735 • 5 cams, 2 keys, mount nut, mount clip and cam screw • 90° cw to open • D4291 KWY</p>  		<p>PIN TUMBLER Left Locking Cam Position C8724 • Replaces Bommer • 90° c/cw to open • D4291 KWY</p>  
<p>PIN TUMBLER Left Locking Cam Position C8725 • Replaces Cutler Federal • 90° c/cw to open • D4291 KWY</p>  	<p>PIN TUMBLER Right Locking Cam Position C8726 • Replaces Riopel - Canada • 90° cw to open • D4291 KWY</p>  	<p>PIN TUMBLER Same as 8735 w/o Cams C8733 • 2 keys, mount nut, mount clip and cam screw • 90° c/cw to open • D4291 KWY</p>  	<p>PIN TUMBLER C9100 • Clockwise C9200 • Counter Clockwise</p>  	<p>PIN TUMBLER C9300 • For private delivery mailboxes only</p>  	<p>MAILBOX LOCK 1600-04-11 • Short Throw • Flat Steel Key</p>  
<p>MAILBOX LOCK 1625-04-11 • Long Throw • Flat Steel Key</p>  	<p>MAILBOX LOCK 1650-04-11 • Long Ear • Flat Steel Key</p>  	<p>MAILBOX LOCK 1675-04-11 • Flat Steel Key</p>  	<p>PIN TUMBLER Left Locking Cam Position 201 • Equivalent to C8721</p>  	<p>PIN TUMBLER Downward Locking Cam Position 202 • Equivalent to C8722</p>  	<p>PIN TUMBLER Left Locking Cam Position 205 • Equivalent to C8723</p>  
<p>PIN TUMBLER Downward Locking Cam Position 208 • Equivalent to C8720</p>  	<p>PIN TUMBLER Left Locking Cam Position 214S • Equivalent to C8714</p>  	<p>PIN TUMBLER Left Locking Cam Position 231 • Equivalent to C8730</p>  	<p>PIN TUMBLER 212K • For Salisbury Mail Boxes</p>  	<p>DISC TUMBLER Drawer 02066-US4 • KD • Cylinder Length: 7/8" • CO68 KWY</p>  	<p>DISC TUMBLER Drawer 02066-26D • KD 02066-US4 • KD, CAT30, CAT60 • Cylinder Length: 7/8" • CO68 KWY</p>  

Mail Box Locks

Desk Locks

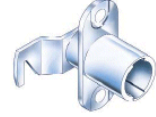
<p>DISC TUMBLER Door 02067-US4 • KD, CAT8, CAT60 • Cylinder Length: 1-1/8" • CO68 KWY</p> 	<p>DISC TUMBLER Door 02067-US4 • KD, CAT8, CAT9 • Cylinder Length: 1-1/8" • CO68 KWY</p> 	<p>DISC TUMBLER Drawer 02068-US4 • CAT60 • Cylinder Length: 7/8" • CO68 KWY</p> 	<p>PIN TUMBLER Drawer 0666-US4 • KA4T37526 • Cylinder Length: 7/8"</p> 	<p>PIN TUMBLER Drawer, 1/2 Bolt Latch 0666-1/2-US4 • KD • Cylinder Length: 7/8"</p> 	<p>PIN TUMBLER Door 0737-26D 0737-US4 • KD, KA4T37526 • Cylinder Length: 7/8"</p> 
<p>PIN TUMBLER Drawer 0738-26D 0738-US4 • KA4T37526 • Cylinder Length: 7/8"</p> 	<p>PIN TUMBLER Drawer 0738-26D • KD, KA4T37526 0738-US4 • KD, KA4T31286 • Cylinder Length: 1-1/8"</p> 	<p>WOOD DRAWER MFW23007B • KD, KA217 in Brass • Cylinder Length: 7/8" • 54G KWY</p> 	<p>WOOD DRAWER MFW23008 • KD in Chrome MFW23008B • KD, KA217 in Brass • Cylinder Length: 1-1/8" • 54G KWY</p> 	<p>METAL DRAWER MFW23010 • KD, KA217 in Chrome • "A" Dimension: 21/32" • 54G KWY</p> 	<p>WOOD DRAWER 1702-04-11 • Brass • KD, KA: EB001, EB002, EB003, EB004, EB005, EB006, EB078 • Cylinder Length: 7/8"</p> 
<p>WOOD DRAWER 1703-04-11 • Brass • KD, KA: EB120 • Cylinder Length: 1-1/8" • KWY</p> 	<p>METAL DRAWER Disc Tumbler C1974 • Chrome • KD, KA1289, KA1454 • "A" Dimension: 19/32" • DK-5 KWY</p> 	<p>METAL DRAWER Disc Tumbler C1975 • Chrome • KD, KA1289, KA1454 • "A" Dimension: 21/32" • DK-5 KWY</p> 	<p>PIN TUMBLER Drawer, Springbolt C8131-26D • KD, KA103 C8131-3 • KD • Cylinder Length: 7/8" • D4291 KWY</p> 	<p>PIN TUMBLER Drawer, Deadbolt C8133-26D • KD, KA103 • Cylinder Length: 7/8" • D4291 KWY</p> 	<p>PIN TUMBLER Drawer, Deadbolt C8135-26D • KD, KA103 • Cylinder Length: 1-1/8" • D4291 KWY</p> 
<p>METAL DRAWER Pin Tumbler C8137-26D • KD, KA103 • Cylinder Length: 19/32" • D4291 KWY</p> 	<p>PIN TUMBLER Drawer, Springbolt C8139-26D • KD, KA103 • Cylinder Length: 3/4" • D4291 KWY</p> 	<p>SHOWCASE LOCK Pin Tumbler C8140-26D • KD, KA103 • D4291 KWY</p> 	<p>LOCK CYLINDER Replacement lock cylinder for drawers C8160-26D • KD • D4292 KWY</p> 	<p>HOUSING Replacement lock housing for drawers C8161-26D • Dead Bolt • Material Thickness: 7/8"</p> 	<p>PIN TUMBLER Drawer, Dead Bolt C8163-26D • KD, KA103 • Cylinder Length: 15/16" • D4291 KWY</p> 
<p>PIN TUMBLER Door, Deadbolt C8173-26D • KD, KA103 • Cylinder Length: 7/8" • D4291 KWY</p> 	<p>PIN TUMBLER Drawer, Deadbolt C8178-26D • KD, KA103 • Cylinder Length: 7/8" • D4291 KWY</p> 	<p>PIN TUMBLER Door, Deadbolt C8174-26D • KD, KA103 • Cylinder Length: 1-1/8" • D4291 KWY</p> 	<p>PIN TUMBLER Drawer, Deadbolt C8177-26D • KD, KA103 • Cylinder Length: 1-1/8" • D4291 KWY</p> 	<p>PIN TUMBLER Door, Deadbolt C8175-26D • KD, KA103 • Cylinder Length: 1-3/8" • D4291 KWY</p> 	<p>PIN TUMBLER Drawer, Deadbolt C8179-26D • KD, KA103 • Cylinder Length: 1-3/8" • D4291 KWY</p> 
<p>MORTISE DR/DW Barrel Key, Dead Bolt, Right Hand C8207-3 • 1 x 2-3/16" C8252-3 • 1 x 1-11/32" • Bolt Travel: 3/16" • D8890 KWY</p> 	<p>MORTISE DOOR Barrel Key, Dead Bolt, Left Hand C8253-3 • 1 x 1-11/32" • Bolt Travel: 3/16" • D8890 KWY</p> 	<p>MORTISE HOOK Barrel Key, Hook Bolt, Chest Lid C8384-3 • Bolt Travel: 5/16" • D8890 KWY</p> 	<p>CHEST LOCK Tumbler, Internal, Engages Strike C8414-4G • Cylinder Length: 7/8" • D8194 KWY</p> 	<p>METAL DRAWER Disc Tumbler C8701-14A • KD, KAC415A • Cylinder Length: 15/16" • D8785 KWY</p> 	<p>DISC TUMBLER Door, Deadbolt C8704-14A • KD, KAC415A C8704-3-KD • Cylinder Length: 15/16" • D8785 KWY</p> 
<p>DISC TUMBLER Drawer, Deadbolt C8703-14A C8703-3 • KD, KAC415A • Cylinder Length: 15/16" • D8785 KWY</p> 	<p>DISC TUMBLER Drawer, Deadbolt C8705-14A • KD, KAC436A C8705-3-KD • Cylinder Length: 1-3/16" • D8785 KWY</p> 	<p>DISC TUMBLER Drawer, Springbolt C8706-3 • KAC415A • Cylinder Length: 15/16" • D8785 KWY</p> 	<p>DISC TUMBLER Drawer, Deadbolt C8803-3 • KD, KAC415A • Cylinder Length: 15/16" • D8785 KWY</p> 	<p>21/64" DR/DW Barrel Key, Dead Bolt, Surface Mounted C8826-3 • Cylinder Length: 21/64" • D8890 KWY</p> 	<p>PLUG CORE For Furniture Locks C8850-14A • MKKD • D8783 KWY</p> 

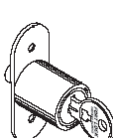
<p>PIN TUMBLER Door, Deadbolt 100DR-26D 100DR-US4 • KD, KA103 • Cylinder Length: 7/8" • D4291 KWY</p>  <p>OLYMPUS LOCK, INC.</p>	<p>PIN TUMBLER Door, Deadbolt 100DR-26D • KD, KA103 • Cylinder Length: 1-3/8" • D4291 KWY</p>  <p>OLYMPUS LOCK, INC.</p>	<p>PIN TUMBLER Drawer, Deadbolt 200DW-26D 200DW-US4 • KD, KA103 • Cylinder Length: 7/8" • D4291 KWY</p>  <p>OLYMPUS LOCK, INC.</p>	<p>PIN TUMBLER Drawer, Deadbolt 200DW-26D • KD, KA103 • Cylinder Length: 1-3/8" • D4291 KWY</p>  <p>OLYMPUS LOCK, INC.</p>	<p>PIN TUMBLER Door, Deadbolt 500DR-26D • KD, KA4T2, KA473 500DR-US4 • KD, KA4T3 • Cylinder Length: 7/8" • D4291 KWY</p>  <p>OLYMPUS LOCK, INC.</p>	<p>PIN TUMBLER Door, Deadbolt 500DR-26D • KD, KA4T2, KA4T3 • Cylinder Length: 1-3/8" • D4291 KWY</p>  <p>OLYMPUS LOCK, INC.</p>
<p>PIN TUMBLER Drawer, Deadbolt 600DW-26D • KD, KA4T2, KA473 600DW-US4 • KD, KA4T3 • Cylinder Length: 7/8" • D4291 KWY</p>  <p>OLYMPUS LOCK, INC.</p>	<p>SCHLAGE "C" REKEYABLE Door 800SC-26D • Cylinder Length: 1-1/8" or 1-3/8" 800SC-US4 • Cylinder Length: 1-1/8"</p> <p>Less Core 700LCA-26D • Cylinder Length: 1-1/8"</p> <p>Less Core 800LCA-26D • Cylinder Length: 1-1/8"</p>  <p>OLYMPUS LOCK, INC.</p>		<p>SMALL FORMAT I/C Door 721DR-26D • Cylinder Length: 1-1/4" • Less Core</p> <p>Drawer 721DW-26D • Cylinder Length: 1-1/4" • Less Core</p>  <p>OLYMPUS LOCK, INC.</p>		<p>PIN TUMBLER Drawer, Deadbolt 600DW-26D • KD, KA4T2, KA4T3 600DW-US4 • KA4T3 • Cylinder Length: 1-3/8" • D4291 KWY</p>  <p>OLYMPUS LOCK, INC.</p>
<p>DISC TUMBLER Drawer, Deadbolt C8896-26D • KD, KAC415A • Cylinder Length: 1/2" • D8785 KWY</p>  <p>CompX NATIONAL</p>	<p>OLYMPUS LOCK, INC.</p>		<p>OLYMPUS LOCK, INC.</p>		<p>4 WAY LATCH Pin Tumbler 998V-26D • KA915 • Cylinder Length: 1-1/4" • D4291 KWY</p>  <p>OLYMPUS LOCK, INC.</p>
<p>DRAWER VH Drawer, Deadbolt N078-26D • KD, KA103 N078-US4 • KD • D4291 KWY</p>  <p>OLYMPUS LOCK, INC.</p>	<p>DRAWER Deadbolt R078-26D R078-US4 • KD, KA4T3 • Cylinder Length: 1-1/8" • KBR-5 KWY</p>  <p>OLYMPUS LOCK, INC.</p>	<p>METAL DRAWER T37-26D • KD, KA103 • Cylinder Length: 19/32" • D4291 KWY</p>  <p>OLYMPUS LOCK, INC.</p>	<p>LOCK PLUG C100LP-14A C200LP-8 C300LP-19 C400LP-20 C500LP-3 • KD, KA100T, KA101T</p>  <p>CompX TIMBERLINE</p>	<p>CYLINDER BODY D500CB • Central Lock Cylinder Body</p>  <p>CompX TIMBERLINE</p>	<p>CYLINDER BODY D550CB • Central Lock Cylinder Body with Deadbolt</p>  <p>CompX TIMBERLINE</p>
<p>CYLINDER BODY C230CB • Surface Drawer Lock</p>  <p>CompX TIMBERLINE</p>	<p>CYLINDER BODY C240CB • Surface Door Lock</p>  <p>CompX TIMBERLINE</p>	<p>FRONT GANG D100CB • Front Gang Lock</p>  <p>CompX TIMBERLINE</p>	<p>FRONT GANG D101CB • Front Gang Lock with single mounting ear</p>  <p>CompX TIMBERLINE</p>	<p>SIDE GANG D150CB • Side Gang Lock</p>  <p>CompX TIMBERLINE</p>	<p>2 DRAWER GANG D270CB • Side Mounted Two Drawer Gang Lock</p>  <p>CompX TIMBERLINE</p>
<p>CYLINDER BODY C250CB • Double Door Lock</p>  <p>CompX TIMBERLINE</p>	<p>CYLINDER BODY C280CB • Surface Drawer Lock</p>  <p>CompX TIMBERLINE</p>	<p>CYLINDER BODY C290CB • Surface Door Lock</p>  <p>CompX TIMBERLINE</p>	<p>CAM LOCK KIT C165CB • Multi Cabinet Cam Lock Kit</p>  <p>CompX TIMBERLINE</p>	<p>CYLINDER BODY C170CB • Thick Panel Lock</p>  <p>CompX TIMBERLINE</p>	<p>CYLINDER BODY C175CB • Push Lock • For locking sliding, bypass type doors</p>  <p>CompX TIMBERLINE</p>
<p>CYLINDER BODY C191CB • Hook Cam Lock • Flipper/Tambour Door Lock</p>  <p>CompX TIMBERLINE</p>	<p>DISC TUMBLER Sliding Door Lock 02069-26D 02069-4 • KD • Length: 7/8"</p>  <p>CCL Security Products</p>	<p>PIN TUMBLER Sliding Door Lock 02290-US4 • KD • Length: 7/8"</p>  <p>CCL Security Products</p>	<p>DISC TUMBLER Sliding Door Lock 02291-US4 • KD • Length: 7/8"</p>  <p>CCL Security Products</p>	<p>DISC TUMBLER Sliding Door Lock, Spring Bolt C1770 • KD, KA1289</p>  <p>CompX CHICAGO</p>	<p>SINGLE BITTED Sliding Door Lock SD990 • KD, KA217 • "A" Dimension: 1-1/32"</p>  <p>CompX PORT</p>

Desk & Cabinet Locks

Plunger Locks

Plunger Locks

DISC TUMBLER
90 Degree Hook Turn
C8042-26D
• KD, C415A
• Length: 7/8"
• D8785 KWY

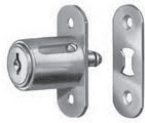

CompX NATIONAL

DISC TUMBLER
Plunger Bolt
C8043-26D
• KD, C415A
• Length: 1"
• D8785 KWY



CompX NATIONAL

PIN TUMBLER
Plunger Bolt
C8142-26D
• KD, KA103
• Length: 1-1/8"
• D4291 KWY



CompX NATIONAL

PIN TUMBLER
Plunger Bolt
C8143-26D
• KD, KA103
• Length: 1-3/8"
• D4291 KWY



CompX NATIONAL

PIN TUMBLER
Sliding Door Lock
300SD-26D
• KD, KA103
• Cylinder Length: 1"
• D4291 KWY



OLYMPUS LOCK, INC.

PIN TUMBLER
Sliding Door Lock
400SD-26D
• KD, KA4T3
400SD-US3-KD
• Cylinder Length: 1"
• R1 KWY



OLYMPUS LOCK, INC.

Vending Machine

TUBULAR
Cylinder For T-Handle
4260-19
• KD, KASP806, KASP808



CompX NATIONAL

TUBULAR
Cylinder For T-Handle
425519RL
• KD, KASP802



CompX NATIONAL

TUBULAR
Ace II Screw Type
CSA4107
• KA7341
• "A" Dimension: 7-1/32"



CompX CHICAGO

T-HANDLE
Screw Type
OU-4265-NA
• "A" Dimension: 3-1/2"



CompX CHICAGO

SHAFT LOCK
TS1058U
• KD, KA
• "A" Dimension: 8"



CompX FORT

TUBULAR
Inner cylinder for pop-out
T-Handle
YPT1010
• KD, KA
• "A" Dimension: 59/64"

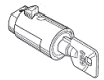

CompX FORT

Switch Locks

DOUBLE BITTED
C2174-1DC-KD
C2174-2DC
• KD, KA2007
• Maintaining
C2174-70DC
• KD, KA
• Momentary
• Single Pole, Single Throw



CompX CHICAGO

ACE II TUBULAR
C4073-2DC
• KD, KA
• Maintaining
C4073-70DC
• KD, KA
• Momentary
• Single Pole, Single Throw



CompX CHICAGO

SWITCH LOCK
C4079-2DC
• KD, KA
• Maintaining
C4079-70DC
• KD, KA
• Momentary

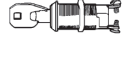

CompX CHICAGO

ACE II
C4235-DC
• KD, KA
• Single Pole, Double Throw



CompX CHICAGO

TUBULAR
Momentary & Maintaining
MFSW3
• KD, KA
• "A" Dimension: 1-3/8"



CompX FORT

T-HANDLE
Flush Mount
2205-KD
• CTC: 1-1/2"
• Y11 KWY



SRS

T-Handle

PIN TUMBLER
Door, Key Removal Unlocked or
Locked Position
C8154-26D
• KD, KA103
• Material Thickness: 1/8"
• D4291 KWY



CompX NATIONAL

PIN TUMBLER
Door, Key Removal Locked
Position Only
C8155-26D
• KD, KA103
• Material Thickness: 1/8"
• D4291 KWY



CompX NATIONAL

T-HANDLE
TA960
• KD, KA
• CTC: 1-1/2"



TA

L-HANDLE
Garage Door Lock
TA965
• KD
• CTC: 1-3/4"



TA

DISC TUMBLER
Rear Mounting, D8785 KWY
C8747-26D
• KD, KAC415A
• Spindle Length: 1"
C8754-26D-KD
• Spindle Length: 3"



CompX NATIONAL

DISC TUMBLER
Mounting Through Escutcheon
C8758-26D-KD
• Spindle Length: 1"
C8759-26D
• KAC415A
• Spindle Length: 3"
• D8785 KWY



CompX NATIONAL

Cabinet Access Control

StealthLock

STEALTH LOCK KIT

SL-100
• StealthLock Kit
• Kit includes: RL-100, TP-100, SP-600 and TL-600



RECIEVER LATCH & STRIKE PLATE

RL-110
• Reciever Latch Kit
• Kit includes: RL-100, SP-600 and TL-600

RL-100
• Reciever Latch Only
SP-600
• Strike Plate Only



TRANSMITTER PAD

TP-100
• Transmitter Pad Only
TP-150
• Dedicated Transmitter Pad



CODELOCKS

MOUNTING PLATE

MP-700
• Keypad Mounting Plate
• Satin Nickel
• Mounting screws and template included

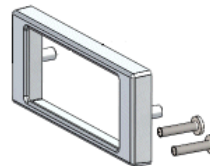

INSTALLATION TOOL

TL-600
• Installation Tool

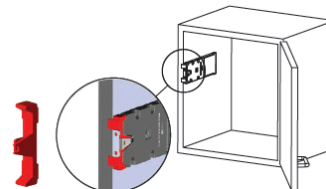

CABINET PUSH BUTTON

CL1006-SG
• Silver Grey
• Two Cams
• One 4 Digit Master Code
• One 4 Digit Sub-Master Code
• One 4 Digit User Code
• User Code, Repeat-Use or Single-Use
• 9V Battery External Jump Start





Electronic Push Button Locksets



ELECTRONIC PUSH BUTTON LOCKSETS

E5000 SERIES LEVER		26D
Exit Trim		
E5010B	Best I/C	Stock
E5010XS	Schlage KNL	Stock
Combination Entry & Key Override		
E5031B	Best I/C	Stock
E5031C	Corbin I/C	Stock
E5031M	Medeco I/C	Stock
E5031R	Sargent I/C	Stock
E5031S	Schlage I/C	Stock
E5031XS	Schlage KNL	Stock
Mortise With No Deadbolt		
E5066B	Best I/C	Stock
E5066S	Schlage I/C	Stock
E5066XS	Schlage KNL	Stock
Mortise With Deadbolt		
E5067S	Schlage I/C	Stock

E2000 SERIES LEVER		26D	06
Combination Entry & Key Override			
E2031XS	Schlage KNL	Stock	Stock
E3000 SERIES LEVER			
Mortise Deadbolt For Adams Rite			
E3065-MS	Schlage KNL	Stock	
E5200 SERIES LEVER			
Combination Entry & Key Override			
E5231XS	Schlage KNL	Stock	
E5700 SERIES LEVER			
Pin/Prox & Key Override			
E5731XS	Schlage KNL	Stock	

MECHANICAL PUSH BUTTON LOCKSETS

1000 SERIES KNOB		26D	05
Combination Entry Only			
1011		Stock	Stock
Combination Entry & Key Override			
1021B	Best I/C	Stock	Stock
1021C	Corbin I/C	Stock	
1021M	Medeco I/C	Stock	Stock
1021S	Schlage I/C	Stock	Stock
L1000 SERIES LEVER			
		26D	05 03
Combination Entry Only			
L1011	Left or Right Hand	Stock	
Combination Entry & Key Override			
L1021B	Best I/C - Left or Right Hand	Stock	
L1021C	Corbin I/C - Left or Right Hand	Stock	
L1021M	Medeco I/C - Left or Right Hand	Stock	
L1021R	Sargent I/C - Right Hand	Stock	
L1021S	Schlage I/C - Left or Right Hand	Stock	Stock
L1021S	Schlage I/C - Left Hand		Stock
Combination Entry & Passage			
L1031	Left Hand		Stock
Combination Entry, Key Override, & Passage			
L1041B	Best I/C - Left or Right Hand	Stock	Stock
L1041S	Schlage I/C - Left or Right Hand		



5000 SERIES LEVER		26D
Combination Entry & Key Override		
5021B	Best I/C	Stock
5021C	Corbin I/C	Stock
5021M	Medeco I/C	Stock
5021R	Sargent I/C	Stock
5021XS	Schlage KNL Cylinder	Stock
Combination Entry, Key Override & D.O.D		
5031M	Medeco I/C	Stock

Mechanical Push Button Locks

*All Locks are Less Cylinder
1000 Series Knobs are Field Reversible, 1000 Series Levers are Non-Reversible

*All Locks are Less Cylinder
5000 Series Levers are Field Reversible



CO100
Rhodes Lever



CO200
Sparta Lever



AD200
Sparta Lever



AD200
Rhodes Lever

PUSH BUTTON LOCKSETS

CO-100 SERIES CLASSROOM/STOREROOM		626	643
CYLINDRICAL			
CO100CY70-KP-RHO	Keypad	Stock	Stock
CO100CY-70-KP-SPA	Keypad	Stock	
MORTISE			
CO100MS-70-KP-RHO	Keypad	Stock	
CO100MS-70-KP-SPA	Keypad	Stock	
CO-200 SERIES CLASSROOM/STOREROOM		626	
CYLINDRICAL			
CO200CY70-KP-RHO	Keypad	Stock	
CO200CY70-KP-SPA	Keypad	Stock	
CO200CY70-PK-RHO	Proximity+Keypad	Stock	
CO200CY70-PK-SPA	Proximity+Keypad	Stock	
MORTISE			
CO200MS70-KP-RHO	Keypad	Stock	
CO200MS70-KP-SPA	Keypad	Stock	
CO200MS70-PK-RHO	Proximity+Keypad	Stock	

PUSH BUTTON LOCKSETS

AD-200 SERIES CLASSROOM/STOREROOM		626	
CYLINDRICAL			
AD200CY70-KP-SPA	Keypad	Stock	
AD200CY70-MK-RHO	Multi-Technology+Keypad	Stock	
AD200CY70-MK-SPA	Multi-Technology+Keypad	Stock	
MORTISE			
AD200MS70-KP-SPA	Keypad	Stock	
AD200MS70-MK-RHO	Multi-Technology+Keypad	Stock	
AD200MS70-MK-SPA	Multi-Technology+Keypad	Stock	

*All Locks are Less Cylinder
AD-200: Offline; user access rights stored in the lock.

*All Locks are Less Cylinder
CO-100: Offline, keypad only, manually programmable only.
CO-200: Offline, user access rights stored in the lock, manually or computer programmable.



WE ALSO HAVE COMPLETE MORTISE ELECTRIFIED LOCKSETS!



ELECTRIFIED LOCKS

FAIL SAFE- GRADE 1		626	613
ND80PDEL-RHO	Storeroom	Stock	Stock
ND80PDEL-SPA	Storeroom	Stock	Stock
ND96PDEL-RHO	Storeroom/Vandlgard	Stock	
ND80BDEL-RHO	Storeroom	Stock	
FAIL SECURE- GRADE 1		626	613
ND80PDEU-RHO	Storeroom	Stock	Stock
ND80PDEU-SPA	Storeroom	Stock	Stock
ND96PDEU-RHO	Storeroom/Vandlgard	Stock	
ND80BDEU-RHO	Storeroom/SFIC Core	Stock	

*All Locks are Less Cylinder

ELECTRIFIED LOCK BODY

- L9080**
 - Fail Safe or Fail Secure
 - Mortise Lock body only
- L9080EL-REX**
 - Fail Safe
 - Mortise Lock body only
 - Request to Exit





DL1200

DL2700

DL2800-IC

DL3500

DL4100

PDL1300



ALARM LOCK



PDL3000-IC



PDK3000



DK3000

Push Button Locks

TRILOGY PUSH BUTTON LOCKS

TRILOGY- Grade 1	26D	10B	
DL1200	X	X	
DL1200 Exit Trim	X		
DL1250	X		
DL1300	x	X	
TRILOGY- Grade 1	26D	10B	3
DL2700	X		
DL2700WP	X		X
DL2700-IC (Best)	X		
DL2700WP-IC-M (Medeco)	X		
DL2775WP-IC-S Regal Lever (Schlage)	X	X	
TRILOGY- Grade 1	26D		
DL2800	X		
DL2800-IC (Best)	X		
DL2875-IC-S Regal Lever (Schlage)			

DL1200, & DL1300 works w/ Adams Rite 4500, 4700, 4900 Series Deadlatch
DL1250 works w/ Adams Rite MS18505 & MS1950 Deadbolts



TRILOGY NETWORKX LOCKS

DL6100-26D

Digital cylindrical lock supporting 5,000 pin user codes (3-6 digits), 500 scheduled events and 35,000 event audit log.

PDL6100-26D

Prox and digital cylindrical lock supporting 5,000 pin user codes (3-6 digits), and/or HID Proximity cards. 500 scheduled events and 35,000 event audit log.

DL6100-26D-UPGRADE

Component kit to upgrade a standard Trilogy cylindrical model to a DL6100 Networkx model.

PDL6100-26D-UPGRADE

Component kit to upgrade a standard Trilogy cylindrical model to a PDL6100 Networkx model.

AL-IME

Ethernet connected gateway. Includes an AC power adapter to plug into standard wall outlet

TRILOGY PUSH BUTTON LOCKS

TRILOGY- Grade 1	26D	
DL3000	X	
DL3000-IC (Best)	X	
DL3200	X	
DL3500CR (Classroom)	X	
DL3500DB (Deadbolt)	X	
DL3575CR Regal Lever (Classroom)	X	
TRILOGY- Grade 1	26D	
DL4100	X	
DL5300	X	
TRILOGY PROX- Grade 1	26D	10B
PDL1300		X
PDL3000	X	
PDL3000-IC (Best)	X	
PDL3500CR (Classroom)	X	
TRILOGY DIGITAL KEYPAD	26D	MS
PDK3000	X	
DK3000		X

PDL1300 works with Adams Rite 4500, 4700, 4900 Series Deadlatch

EXIT TRIM FOR VON 99

ETDL-R1G-26D-V99

ETDL-S1G-26D-V99

- Regal Lever Design
- Straight Lever Design
- V99 Exit Trim For Von Duprin 99/98 • 2000 User Codes: Master, manager, supervisor and users
- Real Time Clock for up to 40,000 Event Time/Date-Stamped Audit Trail
- Up to 500 Lock/Unlock Schedules (with Time Zone Support)



ALARM LOCK



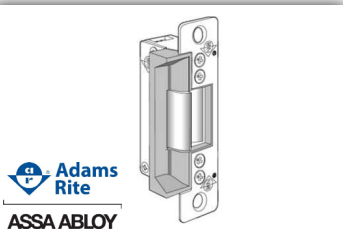

24V ELECTRIC STRIKE

- 7100-510-313**
- Fail Secure
 - 24 Volt / DC Continuous / Flat Model
- 7100-540-628**
- Fail Secure
 - 24 Volt / AC Int / Flat Model
 - Strike: 5/8" x 1-7/16" x 1/2" Deep
 - Case: 1" x 3-3/8" x 1-5/8"
 - Lip length for 1-3/4" thick door that closes flush with jamb edge

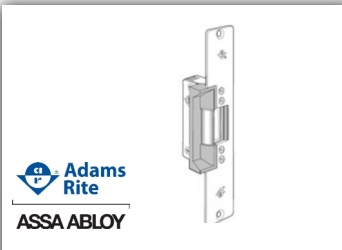

24V ELECTRIC STRIKE

- 7130-540-628**
- Fail Secure
 - 24 Volt / AC Intermittent
 - Strike: 5/8" x 1-7/16" x 1/2" Deep
 - Case: 1" x 3-3/8" x 1-5/8"
 - Lip length for 1-3/4" thick door that closes flush with jamb edge

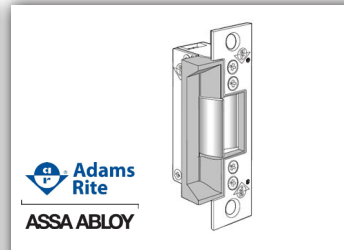

12V ELECTRIC STRIKE

- 7140-340-313**
- 7140-340-628**
- Fail Secure
 - 12 Volt / AC Intermittent
 - Strike: 5/8" x 1-7/16" x 1/2" Deep
 - Case: 1" x 3-3/8" x 1-5/8"
 - Lip length for 1-3/4" thick door that closes flush with jamb edge



24V ELECTRIC STRIKE

- 7140-540-313**
- 7140-540-628**
- Fail Secure
 - 24 Volt / AC Intermittent
 - Strike: 5/8" x 1-7/16" x 1/2" Deep
 - Case: 1" x 3-3/8" x 1-5/8"
 - Lip length for 1-3/4" thick door that closes flush with jamb edge



24V ELECTRIC STRIKE

- 7170-540-313**
- 7170-540-628**
- Fail Secure
 - 24 Volt / AC Intermittent
 - Strike: 5/8" x 1-7/16" x 5/8" Deep
 - Case: 1" x 3-3/8" x 1-7/8"
 - Lip length for 1-3/4" thick door that closes flush with jamb edge



ADAMS RITE ULTRA LINE

- 7170-540-313**
- 7170-540-628**
- Fail Secure
 - 24 Volt / AC Intermittent
 - Strike: 5/8" x 1-7/16" x 5/8" Deep
 - Case: 1" x 3-3/8" x 1-7/8"
 - Lip length for 1-3/4" thick door that closes flush with jamb edge



ELECTRIC STRIKE

- 1006-12/24-630**
- Fail Secure
 - 3000 lbs. static strength
 - Field selectable, 12 or 24VDC
 - Frame: Steel, aluminum or wood
 - Non-handed
 - Five year limited warranty



FIRE RATED

- The 4500 series is the first electric strike designed for installation in 2" UL 10C fire-rated frames with 1/2" drywall penetration
- 4500-12/24-630**
- 3000 lbs. static strength
 - Dual volt 12 or 24 VDC/VAC
 - Field selectable, fail safe / secure
 - Non-handed
 - Five year limited warranty



ELECTRIC STRIKE

- 5000-12/24-630**
- 1500 lbs. static strength
 - Dual volt 12 or 24 VDC/VAC
 - Field selectable, fail safe / secure
 - Non-handed
 - Five year limited warranty



ELECTRIC STRIKE

- 8000-12/24-630**
- UL 1034, burglary-resistant
 - 1500 lbs. static strength
 - Dual volt 12 or 24 VDC/VAC
 - Field selectable, fail safe / secure
 - Non-handed
 - Five year limited warranty
 - Accommodates 1/2" - 5/8" cylindrical latchbolt (5/8" with 1/8" door gap)



CONCEALED

- 8500-12/24-630**
- Concealed Electric Strike for Mortise Locksets
 - UL 10C-fire-rated, 3 hr single-door fire (fail secure only)
 - 1500 lbs. static strength
 - Dual volt 12 or 24 VDC/VAC
 - Field selectable, fail safe / secure
 - Non-handed



CONCEALED

- 9400-12/24-630**
- UL 1034, burglary-resisted
 - 1500 lbs. static strength
 - Dual volt 12 or 24 VDC/VAC
 - Field selectable, fail safe / secure
 - Non-handed
 - Frame: Metal or wood
 - Five year limited warranty



GENESIS™ STRIKE

9600-12/24-630

- UL 1034, burglary-resisted
- 1500 lbs. static strength
- Dual volt 12 or 24 VDC/VAC
- Field selectable, fail safe / secure
- Non-handed
- Frame: Metal or wood
- Five year limited warranty

9600-12/24-LBM-630

- Latch Bolt Monitor



ELECTRIC STRIKE

001 Brass

- 8-16 Volts AC, 3-6 Volts DC
- Fail Secure
- Faceplate: 5-7/8" x 1-1/4"
- Backset: 1-9/16"
- Case: 15/16" x 3-5/8" x 1-7/16"



ELECTRIC STRIKE

**220 Brass
220 Chrome**

- 8-16 Volts AC, 3-6 Volts DC
- Fail Secure
- Faceplate: 5-7/8" x 1-1/4"
- Backset: 1-9/16"
- Case: 15/16" x 3-5/8" x 1-7/16"
- Latch: 1 3/8" opening



ELECTRIC STRIKE

002 Brass

- 8-16 Volts AC, 3-6 Volts DC
- Fail Secure
- Faceplate: 7-15/16" x 1-7/16"
- Backset: 1-9/16"



MORTISE DOOR OPENER

2 Chrome

- 8-16 Volts AC, 3-6 Volts DC
- Fail Secure
- Faceplate: 7-15/16" x 1-7/16"
- Backset: 1-9/16"



ELECTRIC STRIKE

004 Brass

- 8-16 Volts AC, 3-6 Volts DC
- Fail Secure
- Faceplate: 6-1/4" x 1-3/8"
- Backset: 2-3/4"



ELECTRIC STRIKE

4 Brass

- 8-16 Volts AC, 3-6 Volts DC
- Fail Secure
- Faceplate: 7-15/16" x 1-7/16"
- Backset: 1-9/16"

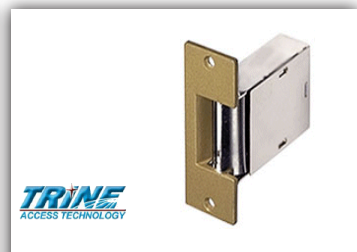

ELECTRIC STRIKE

005 Brass

- 8-16 Volts AC, 3-6 Volts DC
- Fail Secure
- Faceplate: 3-1/2" x 1-3/8"
- Backset: 2-3/4"

HD005 Brass
Screwed-on faceplate and reinforced latch pin for additional strength

005-24VAC Brass

- 24 Volts



ELECTRIC STRIKE

5 Brass

- 8-16 Volts AC, 3-6 Volts DC
- Fail Secure
- Faceplate: 1-3/8" x 3-1/2"
- Backset: 2-3/4"



ELECTRIC STRIKE

S005 Brass

- 8-16 Volts AC, 3-6 Volts DC
- Fail Secure
- Faceplate: 3-1/2" x 1-3/8"
- Backset: 2-7/8"



ELECTRIC STRIKE

5S Chrome

- 8-16 Volts AC, 3-6 Volts DC
- Fail Secure
- Deeper keeper for 3/4" latch projection



ELECTRIC STRIKE

003 Black

- 8-16 Volts AC, 3-6 Volts DC
- Fail Secure
- Faceplate: 4-11/16" x 1-1/4"



ELECTRIC STRIKE

006 Brass

- 8-16 Volts AC, 3-6 Volts DC
- Fail Secure
- Faceplate: 2-1/8" x 1-3/16"
- Backset: 2-7/8"



ELECTRIC STRIKE

007 Brass

- 8-16 Volts AC, 3-6 Volts DC
- Fail Secure
- Faceplate: 4-7/8" x 1-1/4"
- Backset: 2-7/8"



ELECTRIC STRIKE

012 Brass

- 8-16 Volts AC, 3-6 Volts DC
- Fail Secure
- Faceplate: 4-7/8" x 1-1/4"
- Backset: 1-5/8"



ELECTRIC STRIKE

014 Brass

- 8-16 Volts AC, 3-6 Volts DC
- Fail Secure
- Faceplate: 2-3/4" x 1-1/8"
- Backset: 1-5/16"



12VDC STRIKE

**2007-12VDC Brass
2007-12VDC Chrome**

- 12 Volts DC
- Fail Secure
- Faceplate: 4-7/8" x 1-1/4"
- Backset: 1-9/16"



12VDC STRIKE

**2009-12VDC Brass
2009-12VDC Chrome**

- 12 Volts DC
- Fail Secure
- Faceplate: 4-7/8" x 1-1/4"
- Backset: 1-9/16"



SMALLEST STRIKE

3234-LC-26D

- 12-24V AC/DC
- Fail Secure
- Faceplate: 1-1/8" x 2-3/4"



SMALLEST BACKSET 1"

3258-LC-26D

- 12-24V AC/DC
- Fail Secure
- Faceplate: 1-1/8" x 2-3/4"
- Backset: 1"



SMALLEST BACKSET 1"

3478-LC-32D

- 12-24V AC/DC
- Fail Secure
- Faceplate: 1-1/8" x 2-3/4"
- Backset: 1"



ELECTRIC STRIKE

**EN400-12DC-32D-LH
EN400-12DC-32D-RH**

- Field selectable, fail safe / secure
- Field reversible, left or right hand

VON DUPRIN.



USE WITH RIM EXIT

For use with rim exit devices on single doors or double doors with mullion applications (hollow metal, aluminum or wood)

6111-32D-24DC

- Dual volt 12 or 24 VDC
- Fail Secure
- Accepts 3/4" throw latchbolt
- Non-handed

VON DUPRIN.



ELECTRIC STRIKE

For use with mortise locks without deadbolt & cylindrical locks on single door, hollow metal frame

6211-32D-24DC

- Dual volt 12 or 24 VDC
- Fail Secure
- Accepts 3/4" throw latchbolt
- Non-handed



FOLGER ADAM
ELECTRIC DOOR CONTROLS

ELECTRIC STRIKE

310-2-24V-DC-630

- UL 10C-fire-rated, 3 hr single-door fire (fail secure only)
- Dual volt 12 or 24 VDC
- Fail Secure
- Accepts 1/2" or 5/8" throw latchbolt
- Non-handed
- Five year limited warranty



FOLGER ADAM
ELECTRIC DOOR CONTROLS

USE WITH RIM EXIT

- Use on rim exit devices with up 3/4" pullman style latchbolts used on single door openings
- 310-4-12V-DC-630**
- UL 10C-fire-rated, 3 hr single-door fire (fail secure only)
 - Dual volt 12 or 24 VDC
 - Fail Secure
 - Accepts 1/2" or 5/8" throw latchbolt



ALARM LOCK

EXIT ALARM PADDLE

250-28

- Models have changeable 2 minute alarm cutoff or manual reset



ALARM LOCK

EXIT ALARM BAR

700-28

700-312

- Models have changeable 2 minute alarm cutoff or manual reset



ALARM LOCK

DOOR ALARM

PG-10

- An exit door alarm designed to deter the use of the secured door by sounding a twin action alarm when opened by unauthorized personnel



ALARM LOCK

DOOR ALARM

PG-21MS

- Silver
- PG-21MB**
- Bronze
- Four "Alarm Modes" for a variety of applications
- Status Indicator
- Mortise Cylinder sold separately
- Two Operating Modes: "Always Armed" and "On/Off"



ALARM LOCK

PUSH BUTTON ALARM

PG-30MS

- Silver
- No cylinder required
- 3 security levels
- 9 VDC battery powered



Cylinder Not Included

DETEX

DOOR EXIT ALARM

EAX-500

- Gray
- Mortise Cylinder sold separately
- 9 VDC battery powered
- Low Battery Alert
- Manual arming, disarming & rearming



DETEX

EXIT CONTROL LOCK

ECL-230D

- UL listed Panic Hardware, ADA compliant
- Battery alarmed
- Non-handed



DETEX

EXIT CONTROL LOCK

ECL-600

- Rim Cylinder sold separately
- When armed, pressing the exit bar sounds an alarm of approximately 100 decibels
- Deadbolt and latchbolt deters unauthorized access from the outside
- Inside and outside key control capabilities allow authorized alarm bypass



DETEX

EXIT ALARM BAR

V40-EB-36

- 36"
- V40-EB-48**
- 48"
- Aluminum
- Adjustable 2 min. re-arming feature for auto re-arm
- 9 VDC battery powered
- Cylinder not included



DETEX

V40 EXIT TRIM

03A-689

- Aluminum
- Pull Trim for use on V40 exit alarm bar
- Cylinder not included

Alarmed Exits

Keypads, Buttons & Switches



V40 EXIT TRIM

09BN-689

- Aluminum
- Storeroom Lever for use on V40 exit alarm bar
- Cylinder not included



INGRESS'R

I-36-3-CL

- Clear Anodized Aluminum with blue wheelchair logo & text "PUSH TO OPEN"
- "By simply bumping the INGRESS'R with the footrest of my wheelchair, I am able to activate the switch to open a door. It's such a clean, simple, truly functional solution."



INGRESS'R RECEIVER

RC1

- Receiver
- Compatible with WIK-SWTRAN433
- 1-1/4" X 2" X 3/4" Deep



INGRESS'R TRANSFER

SWTRAN433

- Transfer Switch
- Pre-wired for quick installation
- One model fits all
- Antenna magnifies signal
- 9 Volt battery included
- 19/64" X 15/16" X 7/32" Deep, not including wiring and battery



MOMENTARY SWITCH

CM-1000/30

- SPST momentary contact switch,
- N/O 6A @ 125VAC, 3A @ 30VDC

CM-1000/35

- SPST maintained contact (on/off) switch
- 6A @ 125VAC, 3A @ 30VDC



FLUSH MOUNT SWITCH

CM-1100

- Fits standard single gang boxes
- Accepts standard mortise cylinders (1" - 1 1/4")
- 1 or 2 switches may be installed
- Heavy duty 1/4" thick aluminum plate



KEYPAD AND CONTROL

SC20

- 20 Code Keypad for Entry Doors

SC-GD1

- Single Code Keypad
- Used with Electric Strikes or Magnetic Locks
- 12-24 VAC or DC



MOMENTARY SWITCH

653-04

- Maintenance

653-05

- Momentary
- Schlage Locknetics 650 Series Keyswitches utilize an innovative magnetic spring design, allows installers to configure clockwise and counterclockwise key turn direction as well as momentary or maintained action in seconds



EMERGENCY EXIT

EEB2

- Switchable green, red and blue ADA lenses
- Integrated retriggerable 30 second timer
- Field selectable 12 VDC or 24 VDC



EMERGENCY EXIT

EEB3N

- Switchable green and red lenses
- Integrated retriggerable 30 second timer
- Field selectable 12 VDC or 24 VDC
- Narrow stile mount



MOMENTARY

PB

- Includes switchable green and red buttons
- Red LED on plate
- 7 Amp rated contacts
- Stainless Steel single gate plate: 4.5" x 2.75"



MOMENTARY

PB2

- Includes switchable green, red and blue ADA lenses
- Red LED on plate where applicable
- 5 Amp rated contacts
- Stainless Steel single gang plate: 4.5" x 2.75"



MOMENTARY SWITCH

PB2E

- Includes switchable green, red and blue ADA lenses
- Red LED on plate where applicable
- 5 Amp rated contacts
- Stainless Steel single gang plate: 4.5" x 2.75"



MOMENTARY SWITCH

PB4L-2

- 1" Stainless Momentary, DPDT, Single Gang
- Illuminated Green Halo-Style Button
- Bi-Color LED
- 4 Amp rated contacts
- Stainless Steel single gang plate: 4.5" x 2.75"



BUZZER

270

- Dual Coil Design
- 92 DB at 3 Feet
- Chrome Finish Cover
- 3-6 VDC/8-16 VAC
- Current draw max 1 amp
- Size: 3" x 2-1/2" x1"



BELL

272

- Chrome Finish Cover
- Dual Coil Design
- 100 DB at 3 Feet
- 3-6 VDC/8-16 VAC
- Current draw max 1.5 Amps
- Size: 2-1/2"



PUSH BUTTON 10PCK

45A

- Silver Rim
- 45G**
- Gold Rim
- 45LA**
- Light Silver Rim
- 45LG**
- Light Gold Rim
- 5/8" body diameter
- Not recommended if exceeds 16V



PUSH BUTTON

66B

- Black with White Bar
- 66LG**
- Lighted Gold with White Bar
- High Impact Plastic Housing
- Dual Contact Design
- Not recommended for use on systems which exceed 30 volts
- 2-3/4"Lx3/4"Wx5/8"H



PUSH BUTTON

JRP

- 1-3/4" body diameter
- SRP**
- 2-3/4" body diameter
- Single Contact
- Polished Brass w/ Black Center
- Not recommended for use on systems which exceed 30 volts



FLOOR MOUNT

2801-US28

- Holding Force: 25 Lbs. (11.3 Kg.)
- Operating Voltages: 24VDC, 24VAC or 120VAC/60Hz
- Current Draw: 0.015
- Amps Continuous (All Voltages)

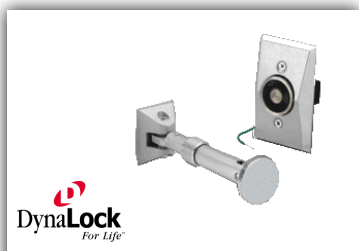

FLUSH WALL MOUNT

2804-US28

- Holding Force: 25 Lbs. (11.3 Kg.)
- Operating Voltages: 24VDC, 24VAC or 120VAC/60Hz Current Draw: 0.015 Amps Continuous (All Voltages)



PROX CARDS & FOBS

ALHID-1326

- Proximity Access Card
- ALHID-1346**
- Proximity Key Fob



PROX CARDS & FOBS

PRX1

- Proximity Access Card
- PF1**
- Proximity Key Fob



I BUTTON FOB

LSE-IBF-100

- 100 P/K
- LSE-IBF-BLUE**
- LSE-IBF-BLACK**
- LSE-IBF-GREEN**

Power Transfers

Software



ELECTRIFIED HINGE

4.5X4.5-26D
4.5X4.5-10B
 • 4 Wire Electrified Hinge
 • Size: 4-1/2 X 4-1/2

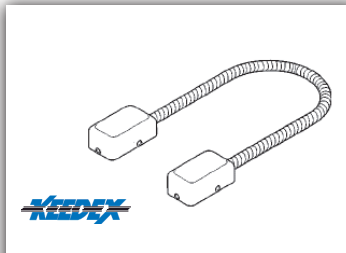

DOOR LOOP

K-DLA
 • Aluminum
K-DLB
 • Durotic
K-DS
 • Stainless
 • Armored Door Loop
 • Size: 18" Length, 1/4" Diameter

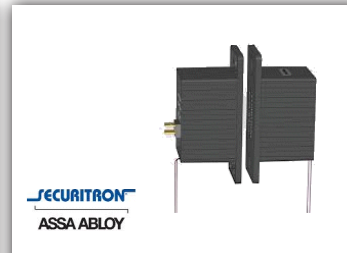

POWER JUMP

ICPT
 • Provides up to .5 amps of power wirelessly
 • Flexible mounting; can be installed on hinge side, latch side or top of frame
 • Power 12VDC or 24VDC locks and latches
 • Continuous or intermittent duty
 • For fail secure devices



DOOR CORD W/ CAPS

TSB-C
 • Consists of an 18" armored stainless steel cable
 • Both light gray and black caps included
 • Cable has an interior diameter of .25"
 • Supports interior wire cables up to .2" thick



SOFTWARE

ALPCI2-U
 • Serial and USB cables
 • Includes DL-Windows software
 • Connects Trilogy locks to PC
 • USB cable connects PC to hand-held data transfer module AL-DTM-III



SOFTWARE

SXPR-SFT-1
 • Effective, simple means to manage access control within your facility
 • Manages PIN Codes, iButtons, Magnetic Stripe Cards and Proximity Credentials
 • One-time access

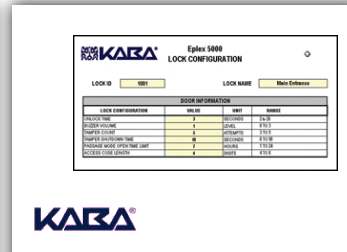

E-PLEX SOFTWARE

EP3000-SW
 • Advanced software for programming 5200/5700 E-Plex locks.

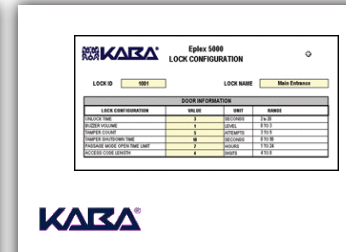

SOFTWARE

EP-EPRISE-XX-001
 • Enterprise Software



KABA M UNIT

EP-MU-COM-001
 • M Unit, Talks to E-Plex locks



EMERGENCY EXIT

MTK15
 • Operating at 125 kHz, the up to six-inch (15.24 cm)
 • Read range reader conveniently integrates into existing proximity-based access control systems and is compatible with most popular proximity credentials
 • Potted electronics and circuitry for protection against weather



HID PROX READER

SXF1050
 • Compatible with 125 kHz proximity including HID®, GE/CASI ProxLite®, and XceedID
 • System Interface: Wiegand
 • Aesthetics: Sleek and attractive architectural styling
 • Mounting: Mullion or narrow stile



HID PROX READER

SXF1550
 • Compatible with 125 kHz proximity including HID®, GE/CASI ProxLite®, and XceedID
 • System Interface: Wiegand
 • Aesthetics: Sleek and attractive architectural styling
 • Mounting: Mullion or narrow stile



SCHLAGE

HID PROX & KEYPAD

SXF2110DP-K

- Compatible with 125 kHz prox including HID®, GE/CASI ProxLite®, and XceedID
- System Interface: Wiegand
- Aesthetics: Sleek and attractive architectural styling



SCHLAGE

600LB MINI MAG

40-630

- Stainless Steel housing
- Door Status Monitor
- Automatic Voltage Selection
- 600 lbs Holding Strength
- 12 or 24 VCD



SCHLAGE

1200LBS HOLD FORCE

70-630

- Stainless Steel housing
- Door Status Monitor
- Automatic Voltage Selection
- 1200 lbs Holding Strength
- 12 or 24 VCD



SCHLAGE

MORTISE SHEAR LOCK

GF3000

- 3000 pounds of force without high operating temperatures normally associated with other Shear Locks.
- Meets ANSI/BHMA A156.23, UL 10C, CUL, CSFM and MEA
- 12 or 24 VCD
- For metal door and frame or glass door with bottom rail and metal frame



SECURITRON
ASSA ABLOY

600LBS HOLD FORCE

M32

- 600 lbs. Holding Force Mag-lock® with automatic dual voltage
- Patented instant release circuit - no residual magnetism
- UL Listed
- 12 or 24 VCD



SECURITRON
ASSA ABLOY

1200LBS HOLD FORCE

M62

- 1200 lbs. Holding Force Mag-lock® with automatic dual voltage
- Patented instant release circuit - no residual magnetism
- UL Listed
- 12 or 24 VCD



StealthLock

STEALTH LOCK KIT

SL-100

- StealthLock Kit
- Kit includes: RL-100, TP-100, SP-600 and TL-600
- TP-100**
- Transmitter Pad Only



StealthLock

RECIEVER LATCH KIT

RL-110

- Reciever Latch Kit
- Kit includes: RL-100, SP-600 and TL-600
- RL-100**
- Reciever Latch Only
- SP-600**
- Strike Plate Only
- TL-600**
- Installation Tool



StealthLock

FACTORY RECIEVER KIT

RL-150

- Reciever Latch Kit Factory Order
- One required per door or drawer
- Mounts within 1/2" drawer suspension
- Operates with 4 AAA batteries



StealthLock

DEDICATED TRANS PAD

TP-150

- Dedicated Transmitter Pad
- Dedicated – Special factory order, unique Transmitter Pad ID mates a Transmitter Pad to specific Receiver Latches. Ideal for lockers or users within close proximity of each other.

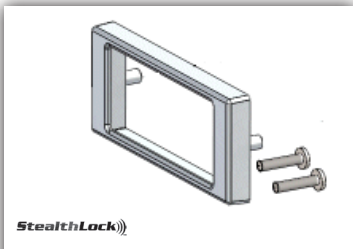

StealthLock

MOUNTING PLATE

MP-700

- Keypad Mounting Plate
- Satin Nickel
- Mounting screws and template included



CODELOCKS

CABINET LOCK

CL1006-SG

- Silver Grey
- Two Cams
- One 4 Digit Master Code, One 4 Digit Sub-Master Code, and One 4 Digit User Code,
- User Code can be Repeat-Use or Single-Use
- 9V Battery External Jump Start

Schlage Levers



Rhodes



Sparta



Saturn



Jupiter



Neptune

Grade 1 Lever		626	625	613	605
ND170	Dummy	RHO			
ND10S	Passage	RHO/SPA	RHO/SPA	RHO/SPA	RHO/SPA
ND25D	Exit	RHO		RHO	
ND40S	Privacy	RHO/SPA	RHO/SPA	RHO/SPA	RHO/SPA
ND44S	Hospital	RHO			
ND50PD	Office	RHO/SPA	RHO	RHO	RHO
ND53PD	Entry	RHO/SPA	RHO/SPA	RHO/SPA	RHO/SPA
ND60PD	Entry	RHO			
ND66PD	Entry	RHO			
ND70PD	Classroom	RHO/SPA	RHO/SPA	RHO/SPA	
ND80PD	Storeroom	RHO/SPA	RHO/SPA	RHO/SPA	RHO/SPA
ND82PD	Storeroom	RHO			
ND85PD	Facility Restroom	RHO			
ND92PD	Entry Lock	RHO	RHO	RHO	RHO
ND93PD	Classroom	RHO			Stock
ND94PD	Classroom	RHO	RHO	RHO	
ND95PD	Classroom	RHO			
ND96PD	Storeroom	RHO	RHO	RHO	RHO

Grade 2 Lever		626	625	613	605
AL170	Dummy	SAT/JUP/NEP	SAT/JUP/NEP		SAT/JUP/NEP
AL10S	Passage	SAT/JUP/NEP	SAT/JUP/NEP	SAT	SAT/JUP/NEP
AL25D	Exit	SAT		SAT	
AL40S	Privacy	SAT/JUP/NEP	SAT/JUP/NEP	SAT	SAT/JUP/NEP
AL50PD	Office	SAT	SAT	SAT	SAT
AL53PD	Entry	SAT/JUP/NEP	SAT/JUP/NEP	SAT	SAT/JUP/NEP
AL70PD	Classroom	SAT	SAT	SAT	SAT
AL80PD	Storeroom	SAT	SAT	SAT	SAT

MORTISE LOCK BODY ONLY!

- L9010B**
 - Passage
- L9040B**
 - Privacy
- L9050LB/70**
 - Entry/Classroom
- L9453LB**
 - Entry/Office w/ Deadbolt
- L9456LB**
 - Corridor w/ Deadbolt



Mortise 03 Lever Grd 1		626	625	613	605
Mortise Rose Trim					
L9050P	Office	A/B	A/B	B	
L9070P	Classroom	B		A	
L9080P	Storeroom	A/B	A/B	A/B	
L9082L	Institution	B			
Mortise Escutcheon Trim					
*L9050L	Office	N			
*L9080L	Storeroom	L/N			
Mortise W/ Deadbolt Rose Trim					
L9453P	Entry	A/B	A/B	A/B	A/B
Mortise W/ Deadbolt Escutcheon Trim					
*L9453L	Entry	L/N			
Mortise 06 Lever Grd 1		626	625	613	
Mortise Rose Trim					
L9010	Passage	A		B	
L9040	Privacy	A		B	
L9050P	Office	A/B	A	A/B	
L9070P	Classroom	A			
L9080P	Storeroom	A/B	B	B	
*L9082L	Institution	A			
Mortise W/ Deadbolt Rose Trim					
L9453P	Entry	A/B	A/B	A/B	

* Less Cylinder

Schlage Mortise Locks



03 Lever



A Rose (2-1/2" Diameter)

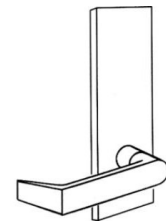

"L" Escutcheon (8" x 2-9/16" x 7/16")



06 Lever



B Rose (2-9/16" Diameter)

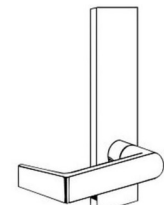

"N" Escutcheon (8" x 1-3/4" x 7/16")



Grade 1 Deadbolt		626	625	613	612	609	605
B660P-238	Single Sided	STOCK	STOCK	STOCK	STOCK	STOCK	STOCK
B660P-234	Single Sided	STOCK		STOCK		STOCK	STOCK
B662P-238	Double Sided	STOCK	STOCK	STOCK	STOCK	STOCK	STOCK
B662P-234	Double Sided	STOCK		STOCK			STOCK
B663P-238	Classroom	STOCK					
B663P-234	Classroom	STOCK					
Grade 2 Deadbolt		626/613/605	625	619	612	609	643
B560P	Single Sided	STOCK	STOCK	STOCK	STOCK	STOCK	STOCK
B562P	Double Sided	STOCK	STOCK	STOCK	STOCK	STOCK	
B571	Indicator	STOCK					
B580	Turn Bolt	STOCK		STOCK			
B581	Turn Bolt	STOCK					



B560P



B580



B571



B660P



B581



Orbit



Plymouth



Tulip



Georgian



Orbit



Plymouth

Grade 2 Knob		626	625	613	612	609	605	643
A170	Dummy	PLY/ORB		PLY	PLY		PLY/ORB	
A10S	Passage	PLY/ORB/TUL	ORB	PLY/ORB	PLY	GEO	PLY/ORB/GEO/TUL	PLY
A25D	Exit	PLY		PLY			PLY	
A30D	Patio	PLY					PLY	
A40S	Privacy	PLY/ORB	ORB	PLY/ORB	PLY	GEO	PLY/ORB/GEO/TUL	
A53PD	Entry	PLY/ORB/TUL	ORB	PLY/ORB	PLY	GEO	PLY/ORB/GEO	PLY
A70PD	Classroom	PLY					PLY	
A80PD	Storeroom	PLY/ORB/TUL		PLY/ORB	PLY		PLY/ORB	PLY

Grade 1 Knob		626	625	613	605
D10S	Passage	PLY			
D40S	Privacy	PLY			
D53PD	Entry	PLY/ORB	PLY	PLY/ORB	PLY
D70PD	Classroom	PLY			PLY
D80PD	Storeroom	PLY/ORB		PLY	PLY
D82PD	Storeroom	PLY			



PLS Knobs- Grade 2		32D	US5	US3	10B
K210	Passage	Stock		Stock	
K240	Privacy	Stock		Stock	
K253	Entrance	Stock	Stock	Stock	Stock
K270	Classroom	Stock			
K280	Storeroom	Stock		Stock	Stock
PLS Knobs- Grade 3		32D	US5	US3	15
K353	Entrance	Stock	Stock	Stock	Stock
K380	Storeroom	Stock		Stock	
K353	Entrance	KW1 Keyway	Stock	Stock	
K380	Storeroom	KW1 Keyway	Stock		
PLS Deadbolts- Grade 1 & 2		32D	US3	10B	
DB160	Single Cyl	Stock	Stock		
DB260	Single Cyl	Stock	Stock	Stock	
DB262	Double Cyl	Stock	Stock		
PLS Deadbolts- Grade 3		32D	US5	US3	15
DB360	Single Cyl	Stock	Stock	Stock	Stock
DB360	Single Cyl	KW1 Keyway	Stock	Stock	Stock

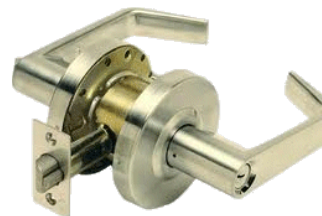

PLS Clutched- Grade 1		26D		
CL110	Passage	Stock		
CL140	Privacy	Stock		
CL153	Entrance	Stock		
CL170	Classroom	Stock		
CL180	Storeroom	Stock		
PLS- Grade 2		26D	10B	US3
L210	Passage	Stock	Stock	Stock
L240	Privacy	Stock	Stock	Stock
L253	Entrance	Stock	Stock	Stock
L270	Classroom	Stock		
L280	Storeroom	Stock	Stock	Stock
PLS Clutched- Grade 2		26D	10B	US3
CL253	Entrance	Stock		Stock
CL280	Storeroom	Stock		

*All Locks Standard Schlage "C" keyway

*All Locks Standard Schlage "C" keyway

Schlage Knobs & Deadbolts

PLS Levers, Knobs & Deadbolts

PLS Hardware



NEW! PLS TYLO STYLE KNOB
400T

- Finishes: 626, 613, 605
- KW1 Keyway

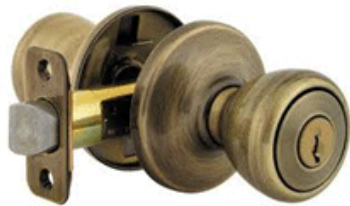

PLS VANDAL PROOF LOCK!

IC80-626

- Inside Lever always free
- IC core & Rose Outside Only
- Grade 1 Cylindrical Chassis
- 2 3/4" Backset, ASA Strike
- Schlage C LFIC
- 1 3/4" thick door only



Inside

MARKS USA

195 SERIES LEVER- Grade 1	26D	US10	10B
195AB Entry	STOCK	STOCK	STOCK
195F Storeroom	STOCK		STOCK
195L Privacy	STOCK	STOCK	
195N Passage	STOCK	STOCK	
195S Classroom	STOCK		
175 SERIES LEVER- Grade 2	26D		
175AB Entry	STOCK		
175F Storeroom	STOCK		
145 SERIES- GRADE 1	32D	US3	10B
145KL Gatelatch Deadbolt with Lever	STOCK	STOCK	STOCK

MARKS USA



195AB Entry

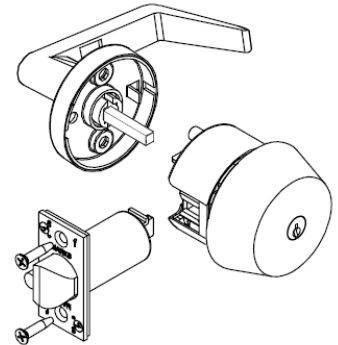

145KL Gatelatch Deadbolt w/ Lever

Marks Levers



PUSH/PULL PADDLE

GHPULL-AL

- Aluminum
- Reversible

GHPUSH-DU

- Durotonic
- Reversible



DEADLATCH LEVER

GHDLL-AL

- Aluminum

GHDLL-DU

- Durotonic



Glass Door Hardware



DEADBOLT MORTISE

GHDB118

- Size: 1-1/8"

GHDB3132

- Size: 31/32"

- Aluminum & Durotonic



HOOKBOLT MORTISE

GHHB118

- Size: 1-1/8"

GHHB3132

- Size: 31/32"

- Aluminum & Durotonic



DEADLATCH MORTISE

GHDL3132

- Size: 31/32"

GHDL118

- Size: 1-1/8"

- Specify Handing

- Aluminum & Durotonic

CYLINDER FLUSH BOLT

360° turn of key throws or retracts hardened hex-section bolt. Key can be removed only when bolt is in a positively locked or unlocked position. Accepts any standard 1-5/32" mortise cylinder from either or both sides. Cylinder must have M.S. cam.

1871-20

- Aluminum
- 31/32" Backset
- Non-Handed



Adams Rite
ASSA ABLOY

875 SERIES TWO-POINT DEADLOCK

For overhead garage doors, roll-up security screens or similar doors. Provides turn operation of two bolts from either or both sides. Accepts standard mortise cylinder(s) for key control of bolts to secure them in either projected or retracted position.

1875-350

- Brass
- 31/32" Backset
- Non-Handed



Adams Rite
ASSA ABLOY

THRESHOLD BOLT

Adding the 4015 bolt to a pivoted bolt MS deadbolt allows Maximum Security for pairs of doors by the turn of a single key. Simultaneously dropping a hardened steel hexbolt into the threshold and pivoting the massive MS bolt into the mating door's stile, the two-point lock secures the entire double door entrance

4015-18-603

- Zinc



Adams Rite
ASSA ABLOY

UPPER BOLT FOR MS1850

Use with MS1850 lock for 2 or 3 point locking.

4016-20-01

- 31/32" Backset
- 4016-30-01**
- 1-1/8" Backset

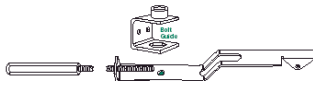

Adams Rite
ASSA ABLOY

DEADLOCK

For installations where the long-throw M.S.® deadlock cannot be accommodated, the smaller 4070 offers the longest practical throw for a conventional projected bolt from a narrow stile. Operates with one-half key turn.

4071-20

- Aluminum
- 31/32" Backset



Adams Rite
ASSA ABLOY

HEADER BOLT

Designed to add a top-of-door third locking point for pairs of doors with an MS pivoted bolt deadlock and 4015 threshold bolt in the active leaf. The 3 point features may be added to any basic MS1851S, MS1851 or MS1851SNSI deadlock.

4085-01

- Aluminum
- 31/32" Backset



Adams Rite
ASSA ABLOY

EXIT INDICATOR

Provides unmistakable notification to building occupants of an exit's "locked" or "open" condition. Under many local building safety codes, this allows the use, in certain occupancies of a security deadlock instead of cumbersome and insecure panic devices. It includes permanently adhesive header sign: "This Door Must Remain Unlocked During Business Hours."

4089-121

- Aluminum or Duranotic



Adams Rite
ASSA ABLOY

NARROW STYLE DOOR LATCH

Face Plate Size: 1" Wide x 6.88" Height. Latchbolt-holdback feature. Field Reversible.

4510-15

- Aluminum
- 7/8" Backset

4510-26

- Aluminum or Duranotic
- 31/32" Backset



Adams Rite
ASSA ABLOY

NARROW STYLE DOOR LATCH

Face Plate Size: 1" Wide x 6.88" Height. Latchbolt-holdback feature. Field Reversible.

4510-36

- Aluminum or Duranotic
- 1-1/8" Backset



Adams Rite
ASSA ABLOY

DEADLOCK LEVER

Easy unlocking of any MS deadbolt by approximately 3 lbs. downward force on a 3" lever.

4550L

- Aluminum or Duranotic
- Left or Right Hand



Adams Rite
ASSA ABLOY

4560 SERIES LEVER

For use with Adams Rite 4500/4900 series deadlatch. Field-Reversible.

4560-501

- Aluminum or Duranotic
- Left Hand

4560-601

- Aluminum or Duranotic
- Right Hand

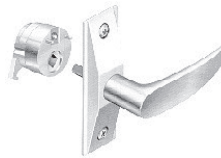

Adams Rite
ASSA ABLOY

4568 SERIES EURO STYLE LEVER

For use with Adams Rite 4500/4700/4900 series deadlatch. Field-Reversible.

4568-501

- Aluminum or Duranotic
- Left Hand

4568-601

- Aluminum or Duranotic
- Right Hand



Adams Rite
ASSA ABLOY

4569 SERIES EURO STYLE LEVER

For use with Adams Rite 4500/4700/4900 series deadlatch. Field-Reversible.

4550L

- Aluminum
- Left Hand

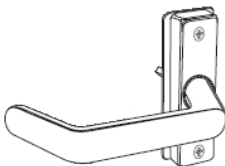

Adams Rite
ASSA ABLOY

4569 SERIES EURO STYLE LEVER

For use with the MS1890, 4500, 4700 or 4900 series deadlatch. Can be set to either Push or Pull, right or left hand. Includes: 4580 Cam Disk, Push & Pull Decal.

4590-02

- Aluminum or Duranotic
- Left Hand

4590-04

- Aluminum or Duranotic
- Right Hand

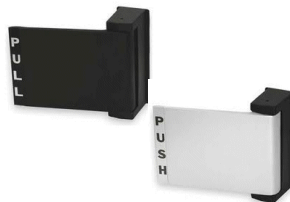

Adams Rite
ASSA ABLOY

LATCH PULL

For use with any Adams Rite 4500 or 4700 or 4900 Series Deadlatches and 8400 Series Mortise Exit Device latches.

4593-07

- Duranotic
- Right Hand Reversible

4593-08

- Aluminum
- Left Hand Reversible

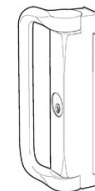

Adams Rite
ASSA ABLOY

NEW STYLE DEADLOCK

On-handed reversible deadlatch. Comes with both radius and flat faceplates. Tube spacer with through-the-front hex key adjustment. One piece cast latch holdback. 5/8" solid brass latchbolt is fully reversible.

4900-35-201

- Aluminum or Duranotic
- 1-1/8" Backset



Adams Rite
ASSA ABLOY

NEW STYLE DEADLOCK W/ STRIKE

On-handed reversible deadlatch. Comes with both radius and flat faceplates. Tube spacer with through-the-front hex key adjustment. One piece cast latch holdback. 5/8" solid brass latchbolt is fully reversible.

4900-45-201

- Aluminum
- 1-1/2" Backset



Adams Rite
ASSA ABLOY

NEW STYLE DEADLOCK W/ STRIKE

On-handed reversible deadlatch. Comes with both radius and flat faceplates. Tube spacer with through-the-front hex key adjustment. One piece cast latch holdback. 5/8" solid brass latchbolt is fully reversible.

4920SNSI-602

- Duranotic
- 1-1/2" Backset



Adams Rite
ASSA ABLOY

Glass Door Hardware

TWO LOCKS IN ONE

Both lock and latch bolts retracted for unrestricted entry and exit during business hours.. Handle-operated latch for exit-only traffic just after closing. Maximum security hookbolt for over-night lockup.

MS+1891-2015

- Aluminum
- 31-32" or 1-1/8" Backset



SWING-UP BOLT

A huge bolt of laminated stainless steel, nearly three inches long, activated by an uncomplicated pivot mechanism, has made this basic MS Deadbolt the standard of the narrow stile door industry.

MS1850S-110

- Aluminum
- 7/8" Backset



SWING-UP BOLT

A huge bolt of laminated stainless steel, nearly three inches long, activated by an uncomplicated pivot mechanism, has made this basic MS Deadbolt the standard of the narrow stile door industry.

MS1851S-210

- Aluminum or Duranotic
 - 31/32" Backset
- MS1851S-310**
- Aluminum or Duranotic
 - 1-1/8" Backset



SWING-UP BOLT

A huge bolt of laminated stainless steel, nearly three inches long, activated by an uncomplicated pivot mechanism, has made this basic MS Deadbolt the standard of the narrow stile door industry.

MS1851S-410

- Aluminum or Duranotic
- 1-1/2" Backset



HOOKBOLT

The MS Hookbolt deadlock answers the security need of sliding glass doors in commercial, industrial and institutional buildings.

MS1851S-250

- Aluminum or Duranotic
- 31/32" Backset

MS1851S-350

- Aluminum or Duranotic
- 1-1/8" Backset



HOOKBOLT

The MS Hookbolt deadlock answers the security need of sliding glass doors in commercial, industrial and institutional buildings.

MS1851S-450

- Aluminum or Duranotic
- 1-1/2" Backset

MS1851SNSI-450

- Aluminum
- 1-1/2" Backset



Sliding Door Hardware

4510/4710 SERIES FACEPLATE

Flat Faceplate Latch for 4510/4710 Series

24-0017-0220

- Aluminum or Duranotic



4511/4711 SERIES FACEPLATE

Radius Faceplate Latch for 4511/4711 Series

24-0017-1220

- Aluminum or Duranotic



MS1850 SNSI SERIES FACEPLATE

Radius Faceplate for MS1850 SNSI Series

24-0226-110

- Aluminum or Duranotic



MS1850 SERIES FACEPLATE

Radius Faceplate for MS1850 Series

24-0384-110

- Aluminum or Duranotic



HOOK/SHORT BOLT FACEPLATE

Radius Faceplate for Hookbolt & Short Bolt

24-0384-120

- Aluminum or Duranotic



CAM DISK

Specify Right or Left Hand
4580



Hinges

ELECTRIFIED HINGE

4 Wire Electrified Hinge. Size 4.5" x 4.5"

4.5X4.5

- Aluminum or Duranotic

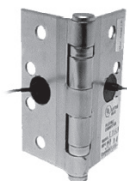

STANDARD HINGE

Standard Weight Hinge. Size 4.5" x 4.5"

BB1279

- Aluminum
- Non-Removable Pin

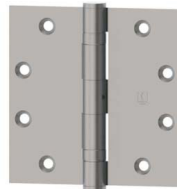

HEAVY HINGE

Heavy Weight Hinge. Size 4.5" x 4.5"

BB1179-NRP

- Aluminum
- Non-Removable Pin

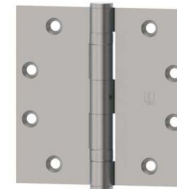

BALL BEARING HINGE

BB74540

- Aluminum
- Size: 4-1/2" X 4"

BB74545

- Aluminum
- Size: 4-1/2" X 4-1/2"

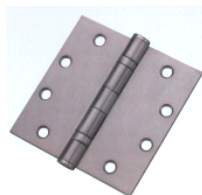

HEAVY WEIGHT HINGE

HWBB74545-NRP

- Aluminum
- Size: 4-1/2" X 4-1/2"
- Non-Removable Pin

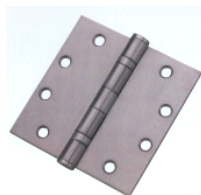

SPRING HINGE

SH74545

- Aluminum
- Size: 4-1/2" X 4-1/2"

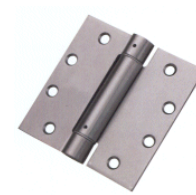

ADA SENIOR SWING

Two-in-one swing door operator when activated opens doors automatically for wheelchair access, yet allows for manual operation. Meets ADA, UL approved. Adjustable hold open, 1 to 32 seconds in automatic or manual mode. Single door, surface mounted, 36" header length is standard.

- 9542-REG-36**
- Aluminum or Duranotic
 - Right or Left Hand



LCN.

OVERHEAD CONCEALED

Body Only. Durable cast iron construction ensures product longevity, 8lb closing force. Non-handed spring adjustable for easy on-site door installation.

- OHC-100**
- Adjustable 3-5
 - 90° or 105°
 - Hold Open or Non-Hold Open



FALCON

OVERHEAD CONCEALED

Body Only. Durable cast iron construction ensures product longevity, 8lb closing force. Non-handed spring adjustable for easy on-site door installation.

- OHC-101**
- Adjustable 1-3
 - 90° or 105°
 - Hold Open or Non-Hold Open



FALCON

SENSAGUARD™

Holder/Release Smoke Detector allows a fire door to remain open for easy passage, but releases door to close in an emergency. Internal ionization smoke detector powered by 9V battery. NFPA 101, Life Safety Code, 5-2.1.8 Self-Closing Devices

- 280 SERIES**
- Adjustable 1-3
 - 90° or 105°
 - Hold Open or Non-Hold Open



IVES

CAST IRON CLOSER

Shipped Tri-Style, mounts hinge side, top jamb and parallel arm. For interior doors to 4'6" and exterior doors to 3'6". Mounts to most common commercial footprint (3/4" x 9 1/16" Norton). Closer meets ADA requirements. Cast Iron Body.

- 1261-RW-PA**
- Aluminum or Duranotic
 - Adjustable 1-5
 - Non-Handed



LCN.

CAST IRON CLOSER

Includes PA Bracket, Self Reaming & Tapping Screws, & Slim Line Cover. Meets ADA Guidelines, ANSI 156.4 Grade 1, UL. Cast Iron Body.

- 1461-RW-PA**
- Aluminum or Duranotic
 - Size: 2" x 2-3/8" x 12-1/4"
 - Non-Handed



LCN.

LCN SMOOTHIE

Heavy-duty cast iron cylinder for exceptional service life. UL and CUL listed. All weather hydraulic fluid eliminates seasonal adjustments. Forged steel main arm. Double heat treated steel pinion.

- 4011-RW-PA**
- Aluminum or Duranotic
 - Left or Right Hand
 - Hinge (pull-side) mounted



LCN.

TRACK ARM CLOSER

Heavy-duty cast iron cylinder for exceptional service life. UL and CUL listed. All weather hydraulic fluid eliminates seasonal adjustments. Hinge (pull-side) mounted

- 4013T-STD**
- Aluminum or Duranotic
 - Left or Right Hand

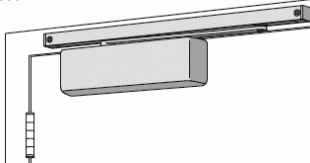

LCN.

LCN 4040XP

The LCN 4040XP sets a new standard for reliability, longevity and value with a beefier design and extraordinary performance testing that goes far beyond industry requirements. LCN® Fast™ Power Adjust with all weather fluid. UL Listed.

- 4040XP-PA**
- Aluminum or Duranotic
 - Hold Open or Non-Hold Open
 - Non-Handed



LCN.

PLS 1900 SERIES

Fits LCN 4040 Foot Print. Non-handed, cast steel, mounting to regular, top jamb or parallel arm. Backcheck Adjustable, Sweep, and Latch.

- DC1916**
- Aluminum or Duranotic
 - Adjustable Size 1-6
 - Non-Handed



PLS
Professional Lock Systems

LCN 4011 CLOSER

Extra duty arm, cover, and self reaming and tapping screws. Closer mounts parallel arm, specify right or left swinging door. Meets ADA requirements.

- 4111**
- Aluminum or Duranotic
 - Left or Right Hand
 - Adjustable 1-5



LCN.

1600 SERIES ADJUSTABLE

Packed for regular arm, top jamb and parallel arm installations. Hole patterns 3/4" - 9 1/16". Non-Handed

- 1601BF**
- Aluminum, Statuary Bronze or Duranotic
 - Adjustable Size 1-4

- 1601**
- Aluminum or Duranotic
 - Adjustable Size 3-6



Norton
ASSA ABLOY

1600 SERIES HOLD OPEN

Separate and independent, latch, sweep and backcheck intensity valves. Packed for regular arm, top jamb and parallel arm installations. All standard arm applications allow doors to swing 180° conditions permitting. Hole patterns 3/4" - 9 1/16".

- 1601H**
- Aluminum
 - Hold Open
 - Adjustable Size 1-4



Norton
ASSA ABLOY

1600 SERIES ADJUSTABLE

Fits Norton 1601 Foot Print. Door Range Up to 180 degrees. Hole patterns 3/4" - 9 1/16". Non-Handed

- 16014**
- Aluminum or Duranotic
 - Adjustable Size 1-4

- 160136**
- Aluminum or Duranotic
 - Adjustable Size 3-6

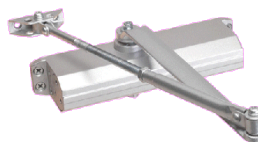

PLS
Professional Lock Systems

1600 SERIES HOLD OPEN

Fits Norton 1601 Foot Print. Door Range Up to 180 degrees. Hole patterns 3/4" - 9 1/16". Non-Handed

- DC1614-HO**
- Aluminum
 - Hold Open
 - Adjustable Size 1-4

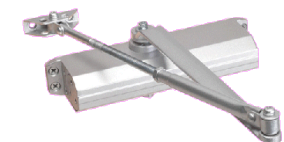

PLS
Professional Lock Systems

1600 SERIES CLOSER

- 1602BC**
1604BC
- Size 2 or 4
 - Aluminum, Statuary Bronze or Duranotic
- 1603BC**
- Aluminum
 - Size 3



Norton
ASSA ABLOY

1600 SERIES HOLD OPEN CLOSER

Tri-Packed- packed for regular arm, top jamb and parallel arm installations.

- 1603BCH**
- Aluminum
 - Hold Open
 - Size 3
 - Non-Handed



Norton
ASSA ABLOY

300 SERIES SIZE 3

Fits Norton 1601 Foot Print. Non-handed, cast aluminium, mounting to regular, top jamb or parallel arm applications. Door Preparation: 9-1/16" horizontal and 3/4" vertical mounting hole locations, retrofits traditional closer.

- DC330**
- Aluminum or Duranotic
 - Size 3
 - Non-Handed

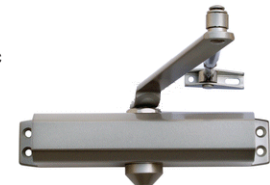

PLS
Professional Lock Systems

Surface Closers

300 SERIES SIZE 4

Fits Norton 1601 Foot Print. Non-handed, cast aluminium, mounting to regular, top jamb or parallel arm applications. Door Preparation: 9-1/16" horizontal and 3/4" vertical mounting hole locations, retrofits traditional closer.

DC340

- Aluminum or Duranotic
- Size 4
- Non-Handed

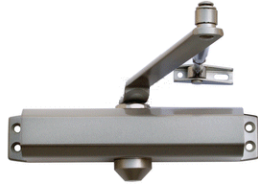

SIZE 3 CLOSER

Grade 2 Closer with Regular or Top Jam Mounting & Full Rack and Pinion. Reversible Handing with Adjustable latching & closing speed.

DX53BC

- Aluminum or Duranotic
- Size 3
- Non-Handed

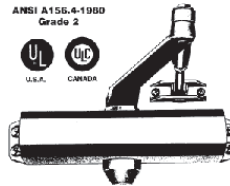

SIZE 4 CLOSER

Grade 2 Closer with Regular or Top Jam Mounting & Full Rack and Pinion. Reversible Handing with Adjustable latching & closing speed.

DX54BC

- Aluminum or Duranotic
- Size 4
- Non-Handed

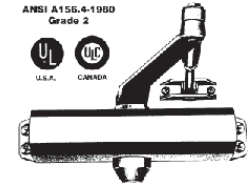

7500 SERIES CLOSER

Packed for regular arm, top jamb and parallel arm installations. All standard arm applications allow doors to swing 180° conditions permitting. 2-1/8" projection.

7500

- Aluminum, Statuary Bronze or Duranotic
- Adjustable Size 1-6
- Non-Handed



ASSA ABLOY

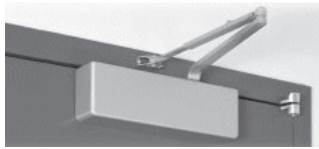

7700 SERIES CLOSER

Separate and independent, latch, sweep and backcheck intensity valves. 2-1/8" projection. 1-1/2" diameter piston.

7704

- Aluminum
- Size 4
- Non-Handed



ASSA ABLOY

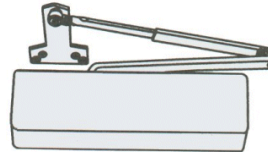

LIGHT DUTY CLOSER

Standard, separate and independent, latch, sweep and backcheck intensity valves. All standard arm applications allow doors to swing 180°, conditions permitting.

P7704

- Duranotic
- Size 4
- Non-Handed



ASSA ABLOY

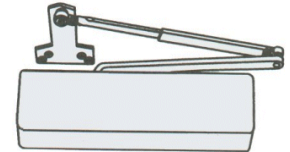

8500 SERIES CLOSER

Tri-Packed- packed for regular arm, top jamb and parallel arm installations. Foot Print: 12" CTC x 3/4" CTC.

8501

- Aluminum or Duranotic
- Adjustable Size 2-6
- Non-Handed



ASSA ABLOY



DELAYED ACTION

Tri-Packed- packed for regular arm, top jamb and parallel arm installations. FullCover Multi-Size Barrier Free Door Closer is a heavy-duty commercial closer. 12" CTC x 3/4"

8501DA

- Aluminum or Duranotic
- Adjustable Size 2-6
- Non-Handed



ASSA ABLOY



1800 SERIES

Fits Norton 8500 blueprint.

DC1816

- Aluminum or Duranotic
- Adjustable Size 1-6
- Non-Handed



ASSA ABLOY

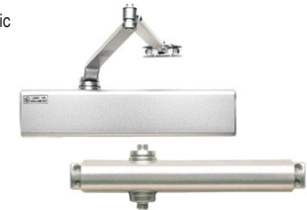

JUST LIKE 8500 SERIES

Footprint is 12" CTC x 3/4" CTC. Meets ANSI A156.4, Grade 1 standards and ADA requirements. Just like Norton 8500 series.

316

- Aluminum or Duranotic
- Adjustable Size 1 to 6
- Non-Handed

Design Hardware



REPLACE ANY CLOSER

Includes Patented Mounting Plate that can replace a Wide variety of door closers without drilling new holes in the door! Can replace: Corbin Russwin, Design, Dorma, Dor-o-matic, LCN, Norton, Ryobi, Sargent & Yale. Non Handed, Parallel Arm Bracket included.

316R

- Aluminum or Duranotic
- Adjustable Size 1 to 6

Design Hardware



POT BELLY CLOSER

The Norton® Series 78B/D represent a combination of traditional styling and modern closer features. All closer sizes are contained within a single size aluminum alloy shell.

78BD-PA

- Aluminum, Statuary Bronze or Duranotic
- B/D = adjustable sizes 2-4
- E/F = adjustable sizes 5-6
- Non-Handed



ASSA ABLOY

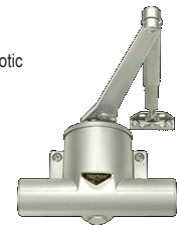

LIGHT DUTY CLOSER

The 9300BC is a light commercial door closer designed for exterior and interior doors such as condominiums, apartments, motels or hotels. Separate and independent valve for sweep speed and latch speed.

9304BC

- Duranotic
- Size 3
- Non-Handed



ASSA ABLOY



DUMMY BAR WITH SWITCH

8099M

- Aluminum, Duranotic



ASSA ABLOY

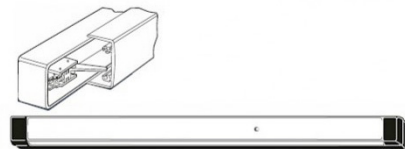

8700 SERIES ELECTRIFIED

Series 8700 for wood and hollow steel combines the ease of installation offered by rim-mounted devices with the clean lines of the Adams Rite pushbar.

8701EL

- Aluminum, Duranotic
- 36"
- 24VDC



ASSA ABLOY

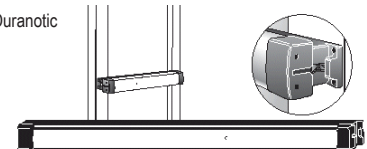

8800 SERIES

Series 8800 for metal stile glass combines the ease of installation offered by rim-mounted devices with the clean lines of the Adams Rite pushbar.

8801

- Aluminum

8802

- Duranotic
- 36"



ASSA ABLOY



8800 SERIES ELECTRIFIED

Electrified Panic Device with solenoid (EL) unlock.

8801EL

- Aluminum
- 36"
- 12VDC or 24VDC



ASSA ABLOY



5000 SERIES

For doors 1-3/4" thick, 4-1/2" minimum stile. Covers stock hollow metal doors with 161 cutout.

5000

- Aluminum
- 36"



ASSA ABLOY



Exit Devices

7700 SERIES

Same footprint as Von Duprin 99.

7700EO

- Aluminum
- 36"



LOCKNETICS TOUCH BAR

672-36

- Aluminum
- 36"



SMARTBAR

The SmartBar is an electronic switching device with no moving parts, which serves as a non-latching exit bar at an egress door. It allows one motion egress at doors equipped with electric, electronic, or electromagnetic locks, with "no prior knowledge" required by the user.

692-36

- Aluminum or Duranotic
- 36"



TOUCH SENSE BAR

The TSB Touch Sense Bar provides touch-triggered release of magnetically locked, non-fire-rated doors. Touching the bar, even through light gloves or clothing, triggers an electronic sensor that releases the lock.

TSB-CL

- Aluminum
- 12 or 24 VDC
- 36"



22 SERIES EXIT DEVICE

For all types of single and double doors with mullion, UL listed for accident hazard installations. Hex Key Dogging

22EO-36

- Aluminum or Duranotic
- 36"

22EO-48

- Aluminum
- 48"



VON DUPRIN.

22 SERIES W/ TRIM EXIT DEVICE

For all types of single and double doors with mullion, UL listed for accident hazard installations. Hex Key Dogging. 230L trim included, Mortise Cylinder using Standard Cam - NOT INCLUDED

22L-36

- Aluminum or Duranotic
- 230L Trim
- 36"



VON DUPRIN.

22 SERIES W/ TRIM EXIT DEVICE

For all types of single and double doors with mullion, UL listed for accident hazard installations. Hex Key Dogging. 210NL trim included, Rim Cylinder - NOT INCLUDED.

22NL-36

- Aluminum or Duranotic
- 210NL Trim
- 36"



VON DUPRIN.

99 SERIES EXIT DEVICE

For all types of single and double doors with mullion, UL listed for accident hazard installations. Hex Key Dogging.

99EO-AL-36

- Aluminum

99EO-313AN-36

- Duranotic
- 36"

99EO-48

- Aluminum
- 48"



VON DUPRIN.

99 SERIES FIRE RATED

Device for Fire Labeled doors. (No dogging feature.) 99 rim exit devices for all types of single and double doors with mullion.

99EO-F

- Aluminum
- 36"
- Fire Rated



VON DUPRIN.

99 SERIES W/ TRIM EXIT DEVICE

For all types of single and double doors with mullion, UL listed for accident hazard installations. Hex Key Dogging. 996L trim included, Mortise Cylinder using Standard Cam - NOT INCLUDED

99L-36

- Aluminum

99L-36

- Duranotic
- 996L Trim
- 36"



VON DUPRIN.

99 SERIES W/ TRIM EXIT DEVICE

For all types of single and double doors with mullion, UL listed for accident hazard installations. Hex Key Dogging. 990NL trim included, Rim Cylinder - NOT INCLUDED.

99NL-36

- Aluminum
- 990NL Trim
- 36"



VON DUPRIN.

PLS RIM DEVICE

Complies with ANSI A156.3, 1994, Grade 1, UL listed. Fits 28" to 36" doors. Stainless steel 5/8" throw. Adjustable with slotted holes for adjustments. Accommodates wood or metal doors.

RPB136-AL

- Aluminum
- 36"



PANIC BAR EXIT ONLY

Meets template requirements #161 cylindrical lock prep. Dead latching. Non-Handed with Hex key dogging.

ED-501

- 36"
- Satin Chrome



ED8000 SERIES

Meets ANSI Grade 1 requirements. Easy-to-use pushpad for quick egress and ADA compliance.

ED8200

- Aluminum
- 36"



NARROW STYLE FOR GLASS DOORS

Bar length 4' can be cut to size. Handed - Not Reversible. Uses standard rim cylinder mounting trim not necessary. Cylinder not included.

1095

- Right Hand Reversible or Left Hand Reversible
- Aluminum or Dark Bronze



VERTICAL ROD DEVICE

Complies with ANSI A156.3, 1994, Grade 1, UL listed. Pullman latch bolts top and bottom.

RPB136-AL

- Aluminum
- 36"



VERTICAL ROD DEVICE

UL listed for Panic Exit Hardware. Non-Handed. Devices are ANSI A156.3 - 2001 Grade 1. Covers stock hollow metal doors with 86 or 161 cutouts.

9927EO

- Aluminum
- 36" or 48"

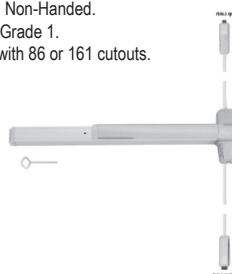

VON DUPRIN.

3' VERTICAL ROD DEVICE

Covers stock hollow metal doors with 161" cutouts. Fits door stiles as narrow as 3-13/16". Non-handed

2227EO

- Aluminum or Duranotic
- 36"



VON DUPRIN.

Vertical Rod Devices

Exit Trim

CONCEALED FIRE RATED RODS

UL listed ANSI A156.3 – 2001 Grade 1 Panic Exit. Non-handed Fire Rated. No Trim, exit only.

9947EO-F

- Aluminum
- 36"



VON DUPRIN.

VERTICAL ROD DEVICE

5000V

- Aluminum
- 36"



VERTICAL ROD DEVICE

5000V

- Aluminum
- 36"



jackson

VERTICAL ROD DEVICE

Meets template requirements #161. For 1-3/4" thick doors, 36" door width.

VR531-A

- Aluminum



CONCEALED VERTICAL ROD

Popular concealed vertical rod exit device - fits on narrow stile aluminum storefront doors. Non-Handed. Supplied with 4" cross-bar, cut to fit. Supplied for standard 7' doors.

1085

- Aluminum or Duranotic



jackson

PLS LEVER TRIM

RLR53

- Aluminum
- Entry/Classroom Function

RLR80

- Aluminum
- Storeroom Function



PLS PULL TRIM

Cylinders NOT INCLUDED

R8P03

- Aluminum
- Wing Pull Trim



22 SERIES PULL TRIM

Cylinders NOT INCLUDED

210NL

- Aluminum or Duranotic
- Pull Trim
- Takes Rlm Cylinder

230NL

- Aluminum
- Pull Trim
- Takes Rlm Cylinder



VON DUPRIN.

22 SERIES LEVER TRIM

Cylinders NOT INCLUDED

230L

- Aluminum or Duranotic
- Lever Trim
- Takes Mortise Cylinder using Standard Cam



VON DUPRIN.

99 SERIES TRIM

Cylinders NOT INCLUDED

990NL-RV

- Aluminum
- Night Latch

996L-RV

- Aluminum or Duranotic
- Lever Trim
- Less Rim Cylinder



VON DUPRIN.

99 SERIES TRIM

Cylinders NOT INCLUDED

996L-RV

- Aluminum or Duranotic
- Lever Trim
- Less Rim Cylinder



VON DUPRIN.

5000 SERIES TRIM

Cylinders NOT INCLUDED

5000-NL

- Aluminum
- Wing Pull



7700 SERIES TRIM

Comes with Sch C Kwy Cylinder

7700-NL

- Stainless Steel



5000 SERIES TRIM

Comes with Sch C Kwy

8000L

- Satin Chrome
- Classroom Function

8000S

- Storeroom Function



5000 SERIES TRIM

Comes with Sch C Kwy

ESC9900

- Satin Chrome
- Classroom Function

ESC9905

- Storeroom Function



ED8000 SERIES TRIM

Comes Less Cylinder

N665

- Satin Chrome
- Classroom Function

N657

- Storeroom Function



ED501 SERIES TRIM

Comes with Schlage "C" Cylinder

LHL580

- Storeroom Function



ED501 SERIES TRIM

Rim Cylinder Not Included

PP-05

- Wing Pull



SIGNATURE BROOKLANE GRD 2					15	11P
	720	Passage	STOCK	STOCK		
	730	Privacy	STOCK	STOCK		

KWIKSET DELTA GRD 3					26D	5	3
	405	Entry	STOCK	STOCK	STOCK		
	462	Storeroom	STOCK		STOCK		



ULTRAMAX DEADBOLT GRD 2					26D/5/3	15/15A
780	Single Sided	STOCK	STOCK			
785	Double Sided	STOCK				

KWIKSET DEADBOLT GRD 3					26D/15/5	11P	3
660	Single Sided	STOCK	STOCK	STOCK			
663	One Sided			STOCK			
665	Double Sided	STOCK		STOCK			

ULTRAMAX POCKET DOOR LK					26D
335	Privacy	STOCK			

GATELOCK					3
559		STOCK			

MAXIMUM POWERBOLT					15	11P
908		STOCK	STOCK			



SCHLAGE ACCENT GRD 3					626	619	605
	F170	Dummy	STOCK				
	F10N	Passage	STOCK	STOCK			
	F40N	Privacy	STOCK	STOCK			
	F51N	Entry	STOCK	STOCK	STOCK		

SCHLAGE FLAIR GRD 3					605
	F170	Dummy	STOCK		
	F10N	Passage	STOCK		
	F40N	Privacy	STOCK		
	F51N	Entry	STOCK		

SCHLAGE ELAN GRD 3					626	605
	F10N	Passage	STOCK	STOCK		
	F40N	Privacy	STOCK	STOCK		



SIGNATURE HANDCOCK GRD 2					26D	15	15A	5/3
	720	Passage	STOCK	STOCK				
	740	Entry	STOCK	STOCK	STOCK			
	741	Entry			STOCK			
	750	Storeroom	STOCK					

SIGNATURE ABBEY GRD 2					26D	5	3
	740	Passage		STOCK			
	741	Privacy		STOCK			
	750	Entry	STOCK	STOCK	STOCK		

KWIKSET POLO GRD 3					26D	15	5	3
	200	Passage	STOCK					
	300	Privacy	STOCK					
	400	Entry	STOCK		STOCK			
	401	Entry						
	450	Storeroom	STOCK	STOCK	STOCK			

KWIKSET COVE GRD 3					15	11P	3
	200	Passage	STOCK	STOCK			
	300	Privacy	STOCK	STOCK			
	400	Entry	STOCK	STOCK	STOCK		

KWIKSET TYLO GRD 3					26D	5	3
	200	Passage	STOCK	STOCK	STOCK		
	300	Privacy		STOCK	STOCK		
	400	Entry	STOCK	STOCK	STOCK		
	401	Entry	STOCK	STOCK	STOCK		



SCHLAGE DEADBOLT GRD 3					626/605	619	609
60N	Single Sided	STOCK	STOCK	STOCK			
62N	Double Sided	STOCK	STOCK	STOCK			

SCHLAGE DEADBOLT GRD 3					626	613	605
250PD	Single Sided	STOCK	STOCK	STOCK			
252PD	Double Sided	STOCK	STOCK	STOCK			

Kwikset Residential Hardware

Schlage Residential Hardware



SCHLAGE PLYMOUTH GRD 3 626 625 619 613 605

	F170 Dummy					STOCK
	F10N Passage	STOCK	STOCK	STOCK		STOCK
	F30N Patio					STOCK
	F40N Privacy	STOCK	STOCK	STOCK		STOCK
	F51N Entry	STOCK	STOCK	STOCK	STOCK	STOCK
	F80N Storeroom	STOCK	STOCK		STOCK	STOCK

SCHLAGE ORBIT GRD 3 626 605

	F170 Dummy		STOCK
	F10N Passage	STOCK	STOCK
	F40N Privacy	STOCK	STOCK
	F51N Entry	STOCK	STOCK
	F80N Storeroom	STOCK	STOCK

SCHLAGE GEORGIAN GRD 3 619 609 605

	F170 Dummy		STOCK	
	F10N Passage	STOCK	STOCK	STOCK
	F40N Privacy	STOCK	STOCK	STOCK
	F51N Entry	STOCK	STOCK	STOCK

SCHLAGE BELL GRD 3 626 605

	F10N Passage	STOCK	STOCK
	F40N Privacy	STOCK	STOCK
	F51N Entry	STOCK	STOCK

SCHLAGE SIENA GRD 3 619 605

	F51N Entry	STOCK	STOCK
--	------------	-------	-------



CAMELOT- GRADE 2 626/619/505

BE365	Keypad Deadbolt	STOCK
-------	-----------------	-------

PLYMOUTH- GRADE 2 505

BE365	Keypad Entry Auto Lock	STOCK
-------	------------------------	-------

CAMELOT X ACCENT- GRADE 2 626/619/505

FE575	Keypad Entry Auto Lock	STOCK
-------	------------------------	-------

FE595	Keypad Entry Flex Lock	STOCK
-------	------------------------	-------

PLYMOUTH X FLAIR- GRADE 2 505

FE575	Keypad Entry Auto Lock	STOCK
-------	------------------------	-------

PLYMOUTH X PLYMOUTH- GRADE 2 505

FE575	Keypad Entry Auto Lock	STOCK
-------	------------------------	-------

FE595	Keypad Entry Flex Lock	STOCK
-------	------------------------	-------

BE365 KEYPAD DEADBOLT

- Deadbolt thrown from outside by keyway turn after pressing Schlage button or by inside thumb turn
- Deadbolt retracted from outside by entering valid user code then rotating keyway turn or by inside thumbturn
- Key can be used as a backup to override lock



Camelot



Plymouth

BE575 ENTRY WITH AUTO-LOCK

- Auto Locking - automatically re-locks after 5 seconds
- Unlocked by valid user code from inside
- Key can be used to unlock as back-up

BE595 ENTRY WITH FLEX-LOCK

- Flex Locking - switch between unlocked or auto relocking
- Unlocked by valid user code from inside
- Inside Knob or Lever always unlocked
- Key can be used to unlock as back-up



Plymouth X Flair



Plymouth X Plymouth



Camelot X Accent

H-SERIES INTERCONNECT LOCK		626	613	605
LEVER				
H110-6	Passage Single Locking	LEV	LEV	LEV
KNOB				
H110-6	Passage Single Locking	PLY		PLY/ORB
H153-6	Entry Double Locking	PLY/ORB	ORB	PLY/ORB
S200-SERIES INTERCONNECT LOCK		626	613	605
LEVER				
S210PD	Passage Single Locking	SAT		SAT
S251PD	Entry Double Locking	SAT/NEP	SAT	SAT
S280PD	Storeroom	SAT		

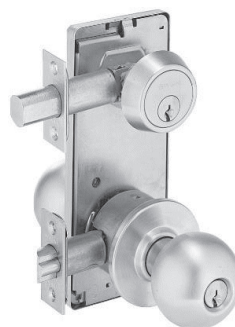

H153 ENTRY DOUBLE LOCKING

H-Series interconnected entrance locks combine our standard cylindrical A-Series lock chassis with the added security and strength of a deadbolt function.

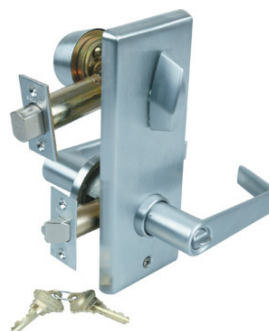

S251 ENTRY DOUBLE LOCKING

When it comes to quick, easy egress and dependable security, Schlage S200-Series interconnected locks get the job done. Designed for applications ranging from military housing to multi-family and small hotel/motel buildings, the S200-Series is a lock you can depend on.



JHIL-30 ENTRY DOUBLE LOCKING

- Meets ADA Barrier Free Regulations
- 4" or 5-1/2" Center to Center
- Door Thickness: 1-3/8" to 1-3/4"
- Deadbolt Backset: 2-3/8" to 2-3/4" Adj.
- Latch Backset: Specify 2-3/8" or 2-3/4"
- 6 Pin Solid Brass Schlage "C" Keyway



DEADLOCK

KW1 Keyway Rim Cylinder

545-53-41

- Boxed
- 545-53-51**
- Vis-Pack

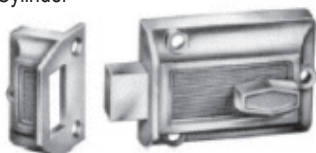

NIGHT LATCH

KW1 Keyway Rim Cylinder

220-53-41

- Boxed
- 220-53-51**
- Vis-Pack

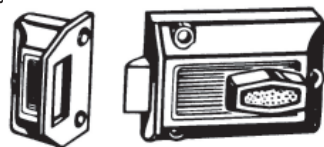

JIMMY PROOF

KW1 Keyway Rim Cylinder, For In-Swinging Doors

530-53-41

- Boxed
- 530-53-51**
- Vis-Pack
- 535-53-51**
- Double Cylinder
- Vis-Pack

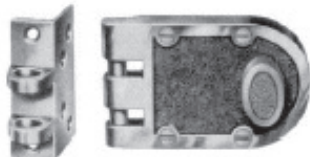

MORTISE LOCKSET BRASS

A universal replacement complete lock includes two (No.209-54) knobs. No. 751 #20 thread spindle, lock body, two trim plates, strike, screws, and two keys. Trim plates 7" x 2-1/4", strike 4" x 1" x 1/16"

215-04-51

- Complete Lock
- Vis-Pack

214-04-51

- Lock Body Only w/ 2 keys
- Vis-Pack

213-04-51

- Escutcheon Trim Plates
- 2/PK
- Vis-Pack

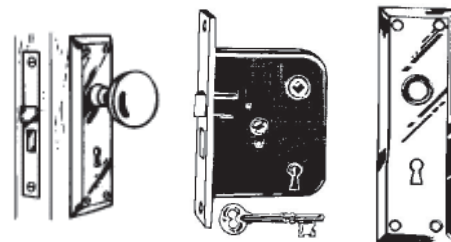

REPLACEMENT KNOBS

A403P

- Solid Brass Colonial design
- Vis-Pack

A410

- Satin Brass Traditional design
- Vis-Pack

AG30P

- Glass Knobs

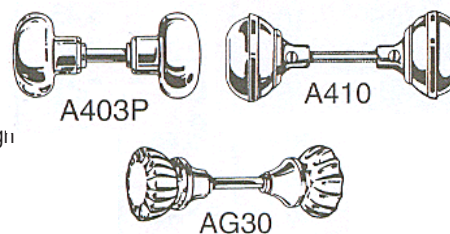

REPLACEMENT ROSES BRASS

211-03-51

- Outside: 2-1/4", Inside: 1/2"

212-03-51

- Outside: 2-1/4", Inside: 11/16"



Interconnected Locks

ILCO Surface Bolts & Mortise Locksets

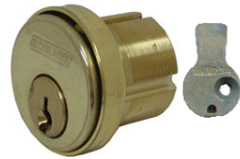

SCHLAGE MORTISE STANDARD KEYWAYS

Mortise Cylinders 1-1/8"		605	613	626	625	612
20-001-C	Standard Cam	STOCK	STOCK	STOCK		STOCK
30-001-C	Schlage "L" Cam		STOCK	STOCK	STOCK	
20-001-CE	Standard Cam	STOCK	STOCK	STOCK		STOCK
20-001-E	Standard Cam	STOCK	STOCK	STOCK		STOCK
20-001-EF	Standard Cam	STOCK	STOCK	STOCK		
20-001-F	Standard Cam	STOCK	STOCK	STOCK		
20-001-FG	Standard Cam			STOCK		
Mortise Cylinder 1-1/4"		605	613	626	612	
20-001-C	Standard Cam	STOCK	STOCK	STOCK	STOCK	
30-001-C	Schlage "L" Cam		STOCK	STOCK		
20-001-CE	Standard Cam	STOCK	STOCK	STOCK		
20-001-E	Standard Cam	STOCK	STOCK	STOCK	STOCK	
20-001-EF	Standard Cam			STOCK		
20-001-F	Standard Cam			STOCK		
20-001-FG	Standard Cam		STOCK	STOCK		
Mortise Cylinder 1-3/8"		605	613	626	625	612
20-001-C	Standard Cam	STOCK	STOCK	STOCK		
30-001-C	Schlage "L" Cam		STOCK	STOCK	STOCK	
20-001-E	Standard Cam	STOCK	STOCK	STOCK		STOCK
30-001-E	Schlage "L" Cam		STOCK			
Mortise Cylinder 1-1/2"		605	613	626	612	
20-001-C	Standard Cam	STOCK	STOCK	STOCK		
20-001-E	Standard Cam	STOCK	STOCK	STOCK	STOCK	

SCHLAGE MORTISE NUMBERED KEYWAYS

Mortise Cylinders 1-1/8"		626
30-001-1246	Schlage "L" Cam	STOCK
30-001-1247	Schlage "L" Cam	STOCK
30-001-1248	Schlage "L" Cam	STOCK
30-001-1345	Schlage "L" Cam	STOCK
30-001-1347	Schlage "L" Cam	STOCK
30-001-1348	Schlage "L" Cam	STOCK
30-001-1456	Schlage "L" Cam	STOCK
30-001-1457	Schlage "L" Cam	STOCK
30-001-1458	Schlage "L" Cam	STOCK
30-001-1467	Schlage "L" Cam	STOCK
30-001-1468	Schlage "L" Cam	STOCK
Mortise Cylinder 1-1/4"		626
30-001-1458	Schlage "L" Cam	STOCK

SCHLAGE MORTISE EVEREST KEYWAYS

Mortise Cylinders 1-1/8"		605	613	626
30-001-C123	Schlage "L" Cam	STOCK	STOCK	STOCK
30-001-C145	Schlage "L" Cam	STOCK	STOCK	STOCK
Mortise Cylinder 1-1/4"		605	613	626
30-001-C123	Schlage "L" Cam	STOCK	STOCK	STOCK
30-001-C145	Schlage "L" Cam	STOCK	STOCK	STOCK

SCHLAGE MORTISE CAMS

Standard Cam: **583-477**
114, 112, 134
583-476
118, 138, 158

"L" Cam: **583-475**
114, 112, 134
583-474
118, 138, 158

Adams Rite Cam: **583-447**
114, 112, 134
583-446
118, 138, 158



SCHLAGE RIM CYLINDERS

20-021
Finish: 605, 613, 626
Standard Keyways:
C, CE, E, EF, F, FG
Everest Keyways:
C123, C124, C145

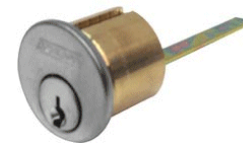

PRIMUS MORTISE, K&L, RIM & I/C CYLINDERS

Mortise Cylinders 1-1/8"		605	613	626	
20-506-1001	UL AR Cam		STOCK		
20-706-1001	AR Cam	STOCK	STOCK	STOCK	
20-787-1001	Schlage "L" Cam	STOCK	STOCK	STOCK	
Mortise Cylinder 1-1/4"		605	613	626	
20-700-1001	Standard Cam	STOCK	STOCK	STOCK	
K&L Cylinders		606	626		
40-700-1001	Multi Tail Piece Pack	STOCK	STOCK		
40-700-1006	Multi Tail Piece Pack	STOCK	STOCK		
Rim Cylinder		605	613	626	625
20-710-1001		STOCK	STOCK	STOCK	STOCK
Large Format I/C Core		626			
23-740-1001		STOCK			



SCHLAGE K&L CYLINDERS

40-100
Finish: 606 or 626
Standard Keyways:
C, CE, E, EF, F, FG, G
Everest Keyways:
C123, C145
Numbered Keyways:
1246, 1247, 1248, 1345, 1347, 1348, 1456, 1457, 1458, 1467, 1468



Schlage Mortise Cylinders

Mortise Cams

Schlage Primus Cylinders



GMS Cylinders

Mortise Cylinders 1" **03** **10B** **26D**

M100-SC	Schlage C kwy	STOCK	STOCK	STOCK
M100-SX	Schlage C-K kwy	STOCK	STOCK	STOCK
M100-KW	Kwickset KW1 kwy	STOCK	STOCK	STOCK
M100D	Dummy Cylinder	STOCK	STOCK	STOCK
M100T	Thumb Turn	STOCK	STOCK	STOCK

Mortise Cylinder 1-1/8" **03** **10B** **26D** **625**

M118-SC	Schlage C kwy	STOCK	STOCK	STOCK
M118-SCE	Schlage E kwy	STOCK	STOCK	STOCK
M118-SX	Schlage C-K kwy	STOCK	STOCK	STOCK
M118-KW	Kwickset KW1 kwy	STOCK	STOCK	STOCK
M118-WR	Weiser WR5 kwy			STOCK
M118-YA	Yale Y1 kwy		STOCK	STOCK
M118-CL4	Corbin L4 kwy			STOCK
M118D	Dummy Cylinder	STOCK	STOCK	STOCK
M118T	Thumb Turn	STOCK	STOCK	STOCK

Mortise Cylinder 1-1/4" **03** **10B** **26D** **625**

M114-SC	Schlage C kwy	STOCK	STOCK	STOCK
M114-SCE	Schlage E kwy	STOCK	STOCK	STOCK
M114-SX	Schlage C-K kwy	STOCK	STOCK	STOCK
M114-KW	Kwickset KW1 kwy	STOCK	STOCK	STOCK
M114-SAX	Sargent LA-LD kwy			STOCK
M114D	Dummy Cylinder	STOCK	STOCK	STOCK
M114T	Thumb Turn	STOCK	STOCK	STOCK

Knob and Lever Cylinders **04** **26D**

K001-SC	Schlage C kwy	STOCK	STOCK
K001-SCE	Schlage E kwy	STOCK	STOCK
K001-SX	Schlage C-K kwy	STOCK	STOCK
K001-KW1	Kwickset KW1 kwy	STOCK	STOCK
K001-CB	Corbin 60 kwy		STOCK
K001-CL4	Corbin L4 kwy		STOCK
K001-RD1	Russwin D1	STOCK	STOCK
K001-SAX	Sargent LA-LD kwy		STOCK
K001-WR	Weiser WR5 kwy	STOCK	STOCK
K001-YA	Yale Y1 kwy	STOCK	STOCK



Rim Cylinders **03** **10B** **26D**

R118-SC	Schlage C kwy	STOCK	STOCK	STOCK
R118-SCE	Schlage E kwy	STOCK	STOCK	STOCK
R118-SX	Schlage C-K kwy	STOCK	STOCK	
R118-KW1	Kwickset KW1 kwy	STOCK	STOCK	STOCK
R118-SAX	Sargent LA-LD kwy			STOCK
R118-WR	Weiser WR5 kwy			STOCK



ILCO MORTISE CYLINDERS

7226-SC1

- Finish: 03, 26D
- 1 3/8" Mortise Cylinder
- Schlage C Keyway
- Standard Cam



ILCO MORTISE CYLINDERS

7246-SC1

- Finish: 03, 26D
- 1 1/2" Mortise Cylinder
- Schlage C Keyway
- Standard Cam



ILCO RIM CYLINDERS

605KW-04-51

- Die Cast
- KW1 Keyway
- Vis-Pack

605SC-04-51

- Die Cast
- Schlage 5-Pin "C" Keyway
- Vis-Pack

605SC-04-41

- Die Cast
- Schlage 5-Pin "C" Keyway
- Boxed



ILCO Cylinders

GMS I/C Cores & Housing

Schlage I/C Cores & Housing



Large Format I/C Cores		26D	04
LFIC-SC	Schlage C kwy	STOCK	STOCK
LFIC-SE	Schlage C kwy	STOCK	STOCK
Small Format I/C Cores		26D	
IC-A-26D	Best A kwy	STOCK	
IC-A-26D-KA	Best A kwy	STOCK	

GMS LFIC I/C CAMS

CAM3-AR

Adams Rite

CAM3-SL

Schlage "L"

CAM3-STD

Standard Cam

CONTROL KEY

IC-A-CUT-CONTROL-KEY

Best A Kwy



GMS SFIC I/C CAMS

CAM2-AR

Adams Rite

CAM2-SL

Schlage "L"

CAM2-STD

Standard Cam



RIM I/C CYLINDERS

20-057C

Finish: 605, 613, 626

"C" Keyway



MORTISE I/C CYLINDERS

26-091C

Finish: 605, 626

"C" Keyway

Standard Cam

26-098C

Finish: 605, 613, 626

"C" Keyway

AR Cam

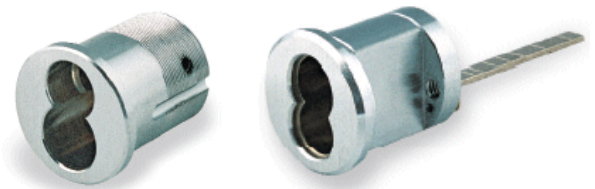

Large Format Mortise Housing		26D
ICS-26D-AR	Adams Rite Cam	STOCK
ICS-26D-SL	Schlage "L" Cam	STOCK
ICS-26D-STD	Standard Cam	STOCK
Small Format Mortise Housing		26D
ICM6-26D-AR	Adams Rite Cam	STOCK
ICM6-26D-SL	Schlage "L" Cam	STOCK
ICM6-26D-STD	Standard Cam	STOCK
Rim Cylinder Housing		26D
ICR-26D	Large Format	STOCK
ICSR-26D	Small Format	STOCK



LARGE FORMAT I/C CORES

23-030

Finish: 606 or 626

Standard Keyways:

C, CE, E, EF, F, FG

Everest Keyways:

C123, C145

Numbered Keyways:

1246, 1247, 1248, 1345, 1347, 1348, 1456, 1457, 1458, 1467, 1468



LARGE FORMAT RIM HOUSING

23-079

Finish: 605, 613, 625, 626



LARGE FORMAT MORTISE HOUSING

20-059

Finish: 605, 613, 625, 626

Cam: Standard





All Locks come Less I/C Core

195 SERIES IC LEVER- Grade 1 26D		
195RAB	Small Format IC Entry	x
195RAB-F19	Schlage IC Entry	x
195RAB-F21	Medeco IC Entry	x
195RF	Small Format IC Storeroom	x
195RF-F19	Schlage IC Storeroom	x
195RF-F21	Medeco IC Storeroom	x
195RS	Small Format IC Classroom	x
195RS-F19	Schlage IC Classroom	x

All Locks come Less I/C Core

Grade 1 Rhodes Lever 626		
Small Format Best I/C Core		
ND53BD	Entry	STOCK
ND70BD	Classroom	STOCK
ND80BD	Storeroom	STOCK
Large Format Schlage I/C Core		
ND53JD	Entry	STOCK
*ND70JD	Classroom	STOCK
ND80JD	Storeroom	STOCK
ND96JD	Storeroom Vandlegard	STOCK

All Locks come Less I/C Core

Grade 2 Saturn Lever 626		
Small Format Best I/C Core		
AL53BD	Entry	STOCK
AL80BD	Storeroom	STOCK
Large Format Schlage I/C Core		
AL53JD	Entry	STOCK
AL70JD	Classroom	STOCK
AL80JD	Storeroom	STOCK



ABUS LARGE FORMAT I/C PADLOCK

2" Wide, 3/8" Shackle, 1-1/2" Clearence

831C/45

Finish: Brass

Schlage Large Format I/C



AMERICAN SMALL FORMAT I/C PADLOCKS

Best Small Format I/C

A3200WO

Finish: Stainless Steel

1-3/4" Wide, 5/16" Shackle, 1-1/8" Clearence

A3260WO

Finish: Stainless Steel

2" Wide, 3/8" Shackle, 1-1/8" Clearence

A3560WO

Finish: Brass

1-3/4" Wide, 5/16" Shackle, 1-1/8" Clearence



AMERICAN LARGE FORMAT I/C PADLOCKS

Schlage Large Format I/C

A3900WO

Finish: Brass

2" Wide, 7/8" Shackle, 1-1/8" Clearence

A3901WO

Finish: Brass

2" Wide, 7/8" Shackle, 2" Clearence



PLS VANDAL PROOF LOCK!

IC80-626

- Inside Lever always free
- IC core & Rose Outside Only
- Grade 1 Cylindrical Chassis
- 2 3/4" Backset, ASA Strike
- Schlage C LFIC
- 1 3/4" thick door only



Master Lock.

MASTER PRO SERIES I/C PADLOCKS

Best Small Format I/C

6421WO

2-1/8" Wide, 5/16" Shackle, 1-1/8" Clearence

6427WO

2-5/8" Wide, 7/16" Shackle, 1-3/8" Clearence

6427LHWO

2-5/8" Wide, 7/16" Shackle, 1-7/8" Clearence

6521WO

2-1/8" Wide, 5/16" Shackle, 3/4" Clearence

6527WO

2-5/8" Wide, 7/16" Shackle, 3/4" Clearence

6831WO

1-9/16" Wide, 1/4" Shackle, 1-1/16" Clearence

6831LFWO

1-9/16" Wide, 1/4" Shackle, 1-9/16" Clearence



SCHLAGE I/C PADLOCK

2" Wide, 3/8" Shackle, 1-1/2" Clearence

KS43D3200

Finish: Brass

Schlage Large Format I/C



Levers & Deadbolt I/C Cores

Padlock I/C Cores

Original Pin Kits

SCHLAGE ORIGINAL PIN KIT
SCH-40-119



KWIKSET ORIGINAL PIN KIT
KWI-272



Kwikset.

SCHLAGE PIN KIT
OEM-S1

- Includes Tweezers & Follower



KWIKSET PIN KIT
OEM-KW1

- Includes Tweezers & Follower



SCHLAGE ORIGINAL PIN KIT
SPK115

- 10 Nickel-Silver Bottom Pins
- 8 Brass Master Pins
- 3 Brass Top Pins
- Cylinder Cap Pins & Springs
- Cylinder Springs
- New LAB T Pins "F" Series
- Compressible Cylinder Springs



KWIKSET ORIGINAL PIN KIT
KPK115

- 10 Nickel-Silver Bottom Pins
- 6 Bottom Pins
- 2 Top Pins
- 2 Anti-Pick Top Pins
- 6 Master Pins
- Stainless Steel Cylinder Springs
- 2 New Anti-Pick Top Pins
- Cylinder Removal Tool & Follower



SCHLAGE & KWIKSET ORIGINAL
LSK2N1

- Nickel-Silver Bottom Pins (Schlage)
- Brass Bottom Pins (Kwikset)
- Brass Master Pins & Top Pins
- Cylinder Springs for Schlage
- Cylinder Springs for Kwikset



SCHLAGE MINI DUR-X ORIGINAL
LMDSCH

- 8 Master Pins (Brass)
- 3 Top Pins (Brass)
- 10 Bottom Pins (Nickel-Silver)
- Cylinder Springs
- Cylinder Cap Pins and Springs



KWIKSET MINI DUR-X ORIGINAL
LMDKWK

- 6 Master Pins
- 2 Top Pins
- 6 Bottom Pins
- Cylinder Springs



Universal Pin Kits

UNIVERSAL MINI

Includes: Masters, Bottoms, Drivers & Springs.

LMK003

.003 Increments

LMK005

.005 Increments



UNIVERSAL SEMI-PRO

LDKU3

- .003 Increments
- 124 Pin Sizes, 1 Spring size
- (T) .10-.200 (B) .156-.360

LDKZ005

- .005 Increments
- 102 Pin Sizes, 1 Spring size
- (T) .10-.300 (B) .150-.360

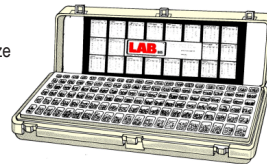

UNIVERSAL PROFESSIONAL

LPK003

- .003 Increments

LPK005

- .005 Increments



UNIVERSAL DUR-X PRO

- .003 Increments
- 124 Pin Sizes, 1 Spring size
- (T) .10-.200 (B) .156-.360

LDKZ005

- .005 Increments
- 102 Pin Sizes, 1 Spring size
- (T) .10-.300 (B) .150-.360



UNIVERSAL SMART WEDGE

LSW003

- .003 Increments

LSW005

- .005 Increments



UNIVERSAL EMERALD WEDGE

EPK003

- .003 Increments
- 124 Pin Sizes, 1 Spring size
- (T) .10-.200 (B) .156-.360

EPK005

- .005 Increments
- 102 Pin Sizes, 1 Spring size
- (T) .10-.300 (B) .150-.360



I/C Core Kit

UNIVERSAL WOODY

LWK003

- .003 Increments
- 104 Pin Sizes, 2 Spring size
- (T) .024-.170 (B) .165-.360



UNIVERSAL SUPER WEDGE

Comes with NO PINS!

EPD003

- 124 Pin Sizes, 1 Spring size

KRP003

- 50/PK 003 Refills

EPD005

- 102 Pin Sizes, 1 Spring size

KRP005

- 50/PK 005 Refills



BEST/FALCON/ARROW I/C KIT

BFK-108

- 10 Brass Bottom Pins- sizes: 0-9
- 18 Brass Master/Top Pins- sizes: 2-19
- 100 Pins per pocket
- 100 Caps, 6&7 Pin Spring Cover
- 2 Different Length Springs



PROFILE CYLINDER FOLLOWER

A simple but effective solution to the frustration of servicing profile cylinders. Special magnetic design for easy operation.

K-19

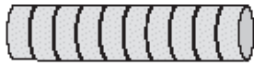

MASTER FOLLOWER

Can be used as a regular follower or master pin remover and follower on Schlage, Sargent, Kwikset, Weiser, Almont Padlocks and many others. Special taper allows smooth operation and better control over sticking pins. Made of solid brass.

K-6



MASTER FOLLOWER

A versatile follower that can be used for removal of upper chamber master pins (up to .100) with a quick twist. Can also be used for standard rekeying tasks. Red anodized machined aluminum to exacting tolerances.

LT-370



4 PIECE FOLLOWER SET

4 different colored aluminum follower tools to easily identify diameter. Two standard size followers, one small and one large diameter combine to offer a set that will service almost any pin tumbler lock. Also available individually.

LT-371

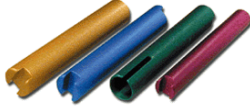

4 PIECE FOLLOWER SET

These 4 Plug Followers will fit virtually all of the rim or mortise cylinders currently in use. They are made of centerless ground bar stock.

SUT-47



PLUG FOLLOWER

SUT-0

• .395 Diameter

SUT-1

• .495 Diameter

SUT-3

• .500 Diameter

SUT-22

• Adj. .495 to .600 Diameter



HOLLOW STEEL FOLLOWER SET

Our Hollow Brass Follower Set contains 3 popular sizes of chrome plated, hollow brass followers. Use these followers on a variety of locks including the Corbin Russwin heavy duty knob lock cylinder units. The small diameter follower is useful for cabinet locks, peanut size cylinders, and pin tumbler letterbox locks.

SUT-14



KWIKSET PLUG FOLLOWER

KWI-152



LAB PLUG FOLLOWER

.495 follower for most Schlage locks.

LFT000

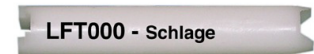

PIN TUMBLER TWEEZERS

The groove in the tip of the Pin Tumbler Tweezers provides a firm, non-twisting grip on cylinder pins for easy loading. The tip is also milled back so that the outside diameter of a standard .115" (2.92mm) pin extends past the tip.

PTT-4



COMPACT PIN TUMBLER TWEEZERS

At only 4" (10cm) long, these tweezers allow you to get closer to the action. The specially milled tips grip top and bottom pins firmly. The PTT-5 is a compact, pocket-sized pinning aid.

PTT-5



TWEEZERS W/ TOP PIN

This magic top loader makes it quick work to return both springs and top pins through the opening for the plug.

TPT-5

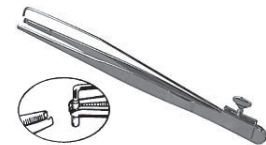

LAB PLUG FOLLOWER

LZT001

- Curved Ends For Positive Grip
- Perfect Size & Weight
- Made of Stainless Steel



KWIKSET KEY GAUGE

KWI-049



SCHLAGE KEY GAUGE

SCH-40-104

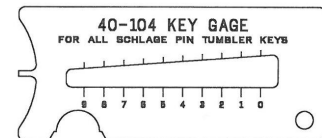

5 IN 1 KEY GAUGE

LKG001

- For Kwikset, Schlage, Weiser, Weslock, and Master



SHIMS & SPRINGS

SS-25

- 25/PK
- .0015 Stainless Steel

115-S

- 100/PK
- Short

115-L

- 100/PK
- Long



PINNING MAT

Pin your cylinders on LABs new workbench counter mat. A must for your lockshop.

LAB-MAT



Aluminum Body

ALUMINUM BODY

Zero Bitted
1-1/2" Wide, 3/4" Thick, 1" Shackle
A1105-BLACK-KZ
A1105-BLUE-KZ
A1105-BROWN-KZ
A1105-GREEN-KZ
A1105-RED-KZ
A1105-YELLOW-KZ



ALUMINUM BODY

1-1/2" Wide, 3/4" Thick, 1" Shackle
A1105-RED-KD
A1105-RED-KA



ALUMINUM BODY

Zero Bitted
1-1/2" Wide, 3/4" Thick, 1-1/2" Shackle
A1106-RED-KZ



ALUMINUM BODY

Zero Bitted
1-1/2" Wide, 3/4" Thick, 3" Shackle
A1107-BLUE-KZ



ALUMINUM BODY

Zero Bitted
1-3/4" Wide, 3/4" Thick, 1-1/8" Shackle
A1205-BLUE-KZ
A1205-GREEN-KZ
A1205-RED-KZ
A1205-YELLOW-KZ



ALUMINUM BODY

1-3/4" Wide, 3/4" Thick, 1-1/8" Shackle
A1205-RED-KD



ALUMINUM BODY

Zero Bitted
1-3/4" Wide, 3/4" Thick, 2" Shackle
A1206-BLUE-KZ



ALUMINUM BODY

Zero Bitted
1-3/4" Wide, 3/4" Thick, 3" Shackle
A1207-BLUE-KZ



ALUMINUM BODY

Zero Bitted
2" Wide, 3/4" Thick, 1-1/8" Shackle
A1305-BLUE-KZ
A1305-RED-KZ
A1305-YELLOW-KZ



ALUMINUM BODY

Zero Bitted
12" Wide, 3/4" Thick, 2" Shackle
A1306-BLUE-KZ



ALUMINUM BODY

Zero Bitted
2" Wide, 3/4" Thick, 3" Shackle
A1307-BLUE-KZ



SOLID BRASS

Rekeyable 5-Pin W6000 Cylinder
1-9/16" Wide, 1/4" Shackle, 1-1/16" Clearance
6830
6830KA
• KA#s 1G001, 10G002
6830KZ
• Zero-Bitted
• W1 or W27 cylinder
6830WO
• Less Cylinder



Master Lock.

SOLID BRASS

Rekeyable 5-Pin W6000 Cylinder
1-3/4" Wide, 5/16" Shackle, 1-3/16" Clearance
6840
6840KA
• KA#s 1G001, 10G002
6840KZ
• Zero-Bitted
• W1 or W27 cylinder
6840WO
• Less Cylinder



Master Lock.

SOLID BRASS BODY

120D
120DKA
Solid Brass 3-Pin Cylinder
• Width: 3/4"
• Shackle: 5/32"
• Clearance: 7/16" x 1/4"
KA#s 1A31, 1A36, 1A38
120K
• Keyblank for 120D



130D
130DKA
Solid Brass 4-Pin Cylinder
• Width: 1-3/16"
• Shackle: 3/16"
• Clearance: 5/8" x 9/16"
KA#s 1B005, 1B019, 1B041
130K
• Keyblank for 130D

150D
150DKA
Solid Brass 5-Pin Cylinder
• Width: 2"
• Shackle: 9/32"
• Clearance: 1" x 1"
KA#s 1K049, 1K062, 1K066, 1K069
150K
• Keyblank for 150D

SOLID BRASS

Rekeyable 5-Pin W6000 Cylinder
2" Wide, 3/8" Shackle, 1-1/2" Clearance
6850
6850KA
• KA#s 1G001, 10G002
6850KZ
• Zero-Bitted
• W1 or W27 cylinder
6850WO
• Less Cylinder



Master Lock.

SOLID BRASS

1" Wide, 5/32" Shackle, 7/16" Clearance
55/25C
55/25KA-5251



SOLID BRASS

140D
140DKA
Solid Brass 4-Pin Cylinder
• Width: 1-9/16"
• Shackle: 1/4"
• Clearance: 7/8" x 13/16"
KA#s 1G003, 1G022, 1G028, 1G032

160D
• Width: 2-3/8"
• Shackle: 9/32"
• Clearance: 1-1/8" x 1-1/4"

Master Lock.

SOLID BRASS

1-1/4" Wide, 3/16" Shackle, 1/2" Clearance
55/30C
55/30KA-5301



SOLID BRASS

1-1/2" Wide, 1/4" Shackle, 7/8" Clearance
55/40C
55/40KA-5401



SOLID BRASS

1-3/4" Wide, 1/4" Shackle, 15/16" Clearance
55/45C
55/45KA-5453



SOLID BRASS

2" Wide, 9/32" Shackle, 15/16" Clearance
55/50C
55/50KA-5503



SOLID BRASS

2-3/8" Wide, 5/16" Shackle, 1-1/4" Clearance
55/60C



Brass Body

<p>SOLID BRASS 5-Pin APTC12 Cylinder 1-1/2" Wide, 1/4" Shackle, 1" Clearance A40D</p>  	<p>SOLID STEEL 5-Pin APTC12 Cylinder 2" Wide, 3/8" Shackle, 1-1/8" Clearance A50D A50KA-A112 A51D • 2" Clearance</p>  	<p>SOLID STEEL Rekeyable, 5-Pin APTC12 Cylinder 2" Wide, 3/8" Shackle, 1-1/8" Clearance A5260 A5260KA • KA#'s 24685, 24767, 25477, 42585, 43753</p>  	<p>SOLID STEEL Rekeyable, 5-Pin APTC12 Cylinder 2" Wide, 3/8" Shackle, 2" Clearance A5261KD A5261KA-24767</p>  
<p>SOLID STEEL Rekeyable, 5-Pin APTC12 Cylinder 2" Wide, 3/8" Shackle, 3" Clearance A5262KD A5262KA-24767</p>  	<p>SOLID STEEL Rekeyable, 5-Pin APTC12 Cylinder 1-1/2" Wide, 1/4" Shackle, 1" Clearance A5100D A5100KA • KA#'s 24685, 42478, 66373</p>  	<p>SOLID STEEL Rekeyable, 5-Pin APTC12 Cylinder 1-1/2" Wide, 1/4" Shackle, 1-1/2" Clearance A5101KA-42478</p>  	<p>SOLID STEEL Rekeyable, 5-Pin APTC12 Cylinder 1-1/2" Wide, 1/4" Shackle, 3" Clearance A5102KA • KA#'s 42478, 66373</p>  
<p>SOLID STEEL Rekeyable, 5-Pin APTC12 Cylinder 1-3/4" Wide, 5/16" Shackle, 1-1/8" Clearance A5200D A5200KA • KA#'s 22358, 22548, 23638, 24685</p>  	<p>SOLID STEEL Rekeyable, 5-Pin APTC12 Cylinder 1-3/4" Wide, 5/16" Shackle, 2" Clearance A5201D A5201KA • KA#'s 22358, 25843, 5374</p>  	<p>SOLID STEEL Rekeyable, 5-Pin APTC12 Cylinder 1-3/4" Wide, 5/16" Shackle, 3" Clearance A5202KA-22358</p>  	<p>SHROUDED SOLID STEEL Rekeyable, 5-Pin APTC12 Cylinder 1-3/4" Wide, 5/16" Shackle, 1-1/8" Clearance A5300D A5300KA-22358</p>  
<p>SHROUDED SOLID STEEL Rekeyable, 5-Pin APTC12 Cylinder 2" Wide, 3/8" Shackle, 1-1/8" Clearance A5360KD A5360KA-26868</p>  	<p>ROUND SOLID STEEL Rekeyable 5-Pin APTC12 Cylinder 2-1/2" Wide, 7/16" Shackle, 1-1/16" Clearance A700D A700KA • KA#'s 26868, 27234, 27244</p>  	<p>ROUND SOLID STEEL Rekeyable 5-Pin APTC12 Cylinder 2-1/2" Wide, 7/16" Shackle, 2" Clearance A701D A701KA • KA#'s 26868, 27234, 43753</p>  	<p>ROUND SOLID STEEL Rekeyable 5-Pin APTC12 Cylinder, Zinc Plated 2-1/2" Wide, 7/16" Shackle, 1-1/16" Clearance A702KA-26868</p>  
<p>TUBULAR CYLINDER Rekeyable, 7-Pin AHTC2 Cylinder 2-1/4" Wide, 7/16" Shackle, 1-1/8" Clearance A7200KD A7200KA-15025</p>  	<p>TUBULAR CYLINDER Rekeyable, 7-Pin AHTC2 Tubular Cylinder 2" Wide, 3/8" Shackle, 1-1/8" Clearance A7260KA • KA#'s 15304, 15864</p>  	<p>TUBULAR CYLINDER Rekeyable, 7-Pin AHTC2 Tubular Cylinder 2-1/4" Wide, 7/16" Shackle, 1-1/8" Clearance A7300KD A7300KA-15230</p>  	<p>TUBULAR CYLINDER Rekeyable, 7-Pin AHTC2 Tubular Cylinder 2-1/4" Wide, 7/16" Shackle, 2" Clearance A7301KD A7301KA-22048</p>  
<p>ROUND PADLOCK Rekeyable, 5-Pin W27 Cylinder 2" Wide, 7/16" Shackle, 1" Clearance 220D 220KA-10L669 220WO • Less Cylinder 220LHKA-10L045 • 2" Clearance</p>  	<p>ROUND PADLOCK Rekeyable, 5-Pin W27 Cylinder 2-1/2" Wide, 7/16" Shackle, 1" Clearance 230D 230KA-10L008 230LHKA-10L008 • 2" Clearance</p>  	<p>#15 MASTER PADLOCK Non-Rekeyable, 5-Pin W15 Cylinder 2-1/2" Wide, 7/16" Shackle, 1-1/4" Clearance 15DPF • Carded 15KA • KA#'s 10N323, 10N814, 19N464</p>  	<p>#17 MASTER PADLOCK Non-Rekeyable, 5-Pin W15 Cylinder 2" Wide, 7/16" Shackle, 1" Clearance 17DPF • Carded 17KA • KA#'s 19T451, 19T452, 19T453, 19T455, 19T459 17LHKA • 2" Clearance</p>  

Brass Body

Solid Steel

Laminated Steel Body

Laminated Steel Body

#1 MASTER PADLOCK

Non-Rekeyable, 4-Pin W1 Cylinder
1-3/4" Wide, 5/16" Shackle, 1-1/2" Clearance
1LF-KD
1LF-KA
• KA#'s 2001, 2002, 2126, 2179, 2204, 2359, 2519, 2625



Master Lock.

#1 MASTER PADLOCK

Non-Rekeyable, 4-Pin W1 Cylinder
1-3/4" Wide, 5/16" Shackle, 2-1/2" Clearance
1DLJ
• Carded
1DLJ-COM
• Commercial, Carded
1LJ-KA
• KA#'s 2001, 2126, 2233, 2339, 2359, 2380, 2519, 3758



Master Lock.

#1 MASTER PADLOCK

Non-Rekeyable, 4-Pin W1 Cylinder
1-3/4" Wide, 5/16" Shackle, 5-3/4" Clearance
1LN-KA
• KA#'s 2001, 2126, 2359, 2363



Master Lock.

#1 UNIVERSAL PIN

Lock Pinned to Customer's Key in Minutes!
1-3/4" Wide, 5/16" Shackle
1UP
• 15-16" Clearance
1UP-LJ
• 2-1/2" Clearance



Master Lock.

LAMINATED STEEL PIN TUMBLER PADLOCK, NON-REKEYABLE

#1 PADLOCK

4-Pin W1 Cylinder
1-3/4" Wide, 5/16" Shackle, 15/16" Clearance
1KD
1KA
KA#'s 2001, 2002, 2004, 2006, 2007, 2008, 2012, 2012, 2013, 2015, 2016, 2018, 2020, 2034, 2035, 2039, 2042, 2043, 2087, 2088, 2094, 2126, 2127, 2151, 2174, 2194, 2196, 2202, 2204, 2207, 2214, 2222, 2239, 2246, 2248, 2258, 2276, 2307, 2309, 2311, 2322, 2339, 2357, 2359, 2380, 2392, 2393, 2396, 2400, 2401, 2402, 2404, 2519, 2539, 2625, 2729, 2750, 2753, 2786, 2803, 2874, 3377
1D
• Carded
1D-COM
• Commercial Version, Carded

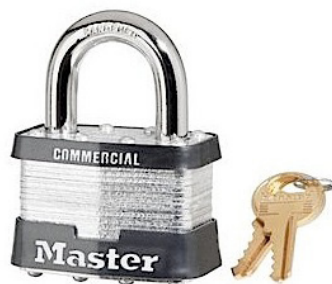

#5 PADLOCK

4-Pin W1 Cylinder
2" Wide, 3/8" Shackle, 1" Clearance
5KD
5KA
KA#'s A105, A112, A1200, A1253, A1348, A141, A142, A1493, A152, A1635, A190, A253, A262, A267, A272, A280, A283, A288, A297, A336, A342, A347, A349, A350, A383, A385, A387, A389, A407, A432, A437, A445, A463, A464, A470, A473, A478, A482, A485, A490, A494, A501, A549, A604, A704, A725, A730, A784, A823
5D
• Carded
5D-COM
• Commercial Version, Carded

Master Lock.

#3 PADLOCK

4-Pin W1 Cylinder
1-9/16" Wide, 9/32" Shackle, 3/4" Clearance
3KD
3KA
KA#'s 0356, 0367, 0380, 0415, 0464, 0483, 0536, 0909, 3202, 3203, 3204, 3205, 3206, 3207, 3208, 3210, 3212, 3213, 3217, 3218, 3220, 3221, 3222, 3223, 3229, 3231, 3233, 3240, 3241, 3252, 3253, 3256, 3303, 3318, 3321, 3322, 3346, 3347, 3358, 3358, 3359, 3362, 3368, 3369, 3375, 3376, 3377, 3378, 3379, 3386, 3413, 3416, 3420, 3438, 3442, 3447, 3464, 3467, 3476, 3523, 3551, 3552, 2553, 3571, 3572, 3600, 3603, 3605, 3623, 3672, 3717, 3752, 3753, 3756, 3779, 3793, 3900, 3909, 3934, 3943, 3945, 3958, 3996
3D
• Carded
3D-COM
• Commercial Version, Carded

#7 PADLOCK

4-Pin W7 Cylinder
1-1/8" Wide, 3/16" Shackle, 9/16" Clearance
7KD
7KA
KA#'s P104, P150, P164, P176, P212, P216, P246, P286, P288, P310, P412, P420, P425, P491, P492, P493, P498, P502, P503, P506, P507, P510, P519, P602, P603, P604, P605, P606, P607, P609, P610, P911, P612, P640, P683, P751, P761, P763, P812, P842
7D
• Carded

#3 MASTER PADLOCK

Non-Rekeyable, 4-Pin W1 Cylinder
1-9/16" Wide, 9/32" Shackle, 1-1/2" Clearance
3DLF
• Carded
3LF-KA
• KA#'s 0464, 0563, 2339, 3205, 3210, 3217, 3252, 3467, 3704, 3751, 3753



Master Lock.

#3 MASTER PADLOCK

Non-Rekeyable, 4-Pin W1 Cylinder
1-9/16" Wide, 9/32" Shackle, 2" Clearance
3DLH
• Carded
3DLH-COM
• Commercial, Carded
3LH-KA
• KA#'s 0464, 3205, 3210, 3347, 3377, 3379, 3447, 3753



Master Lock.

#3 UNIVERSAL PIN

Lock Pinned to Customer's Key in Minutes!
1-9/16" Wide, 9/32" Shackle
3UP
• 3/4" Clearance
3UP-LF
• 1-1/2" Clearance



Master Lock.

#5 MASTER PADLOCK

Non-Rekeyable, 4-Pin W1 Cylinder
2" Wide, 3/8" Shackle, 1-1/2" Clearance
5DLF
• Carded
5DLF-COM
• Commercial, Carded
5LF-KD
5LF-KA
• KA#'s A297, A473, A490



Master Lock.

#5 MASTER PADLOCK

Non-Rekeyable, 4-Pin W1 Cylinder
2" Wide, 3/8" Shackle, 2-1/2" Clearance
5LJ-KD
5LJ-KA
• KA#'s A473, A482, A490



Master Lock.

#5 UNIVERSAL PIN

Lock Pinned to Customer's Key in Minutes!
2" Wide, 3/8" Shackle
5UP
• 1" Clearance
5UP-LF
• 1-1/2" Clearance



Master Lock.

#7 MASTER PADLOCK

Non-Rekeyable, 4-Pin W7 Cylinder
1-1/8" Wide, 3/16" Shackle, 1-1/2" Clearance
7DLF
• Carded
7LF-KD
7LF-KA
• KA#'s P216, P761, P812



Master Lock.

#7 MASTER PADLOCK



















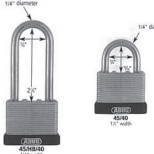



Non-Rekeyable, 4-Pin W7 Cylinder
1-1/8" Wide, 3/16" Shackle, 2-1/2" Clearance
7LJ-KD
7LJ-KA
• KA#'s P220, P640, P761, P812



Master Lock.

Laminated Steel Body

Laminated Brass Body

<p>#21 REKEYABLE 4-Pin W1 Cylinder, Zero-Bitted 1-3/4" Wide, 5/16" Shackle, 15/16" Clearance 21-KZW1 21LF-KZW1 • 1-1/2" Clearance 21LJ-KZW1 • 2-1/2" Clearance 21LN-KZW1 • 5-3/4" Clearance</p>  <p>Master Lock.</p>	<p>#21 REKEYABLE W/O Cylinder 1-3/4" Wide, 5/16" Shackle, 15/16" Clearance 21-WO 21LJ-WO • 2-1/2" Clearance</p>  <p>Master Lock.</p>	<p>#25 REKEYABLE 4-Pin W1 Cylinder 2" Wide, 3/8" Shackle, 1" Clearance 25-KZW1 • Zero-Bitted 25-WO • W/O Cylinder 25-LJWO • 2-1/2" Clearance • W/O Cylinder</p>  <p>Master Lock.</p>	<p>#27 REKEYABLE 4-Pin W1 Cylinder 2" Wide, 7/16" Shackle, 1" Clearance 27-KZW1 • Zero-Bitted 27-WO • W/O Cylinder 27LH-WO • 2" Clearance • W/O Cylinder 27LH-WCS • Lock Body Only</p>  <p>Master Lock.</p>
<p>#1 MASTER KEYED 4-Pin W1 Cylinder 1-3/4" Wide, 5/16" Shackle, 15/16" Clearance 1MK • MK#s SM10, SM19, SM22, SM23</p>  <p>Master Lock.</p>	<p>#3 MASTER KEYED 4-Pin W1 Cylinder 1-9/16" Wide, 9/32" Shackle, 3/4" Clearance 3MK • MK#s SM730, SM733</p>  <p>Master Lock.</p>	<p>#5 MASTER KEYED 4-Pin W1 Cylinder 2" Wide, 3/8" Shackle, 1" Clearance 5MK • MK#s SM866, SM873</p>  <p>Master Lock.</p>	<p>#7 MASTER KEYED 4-Pin W7 Cylinder 1-1/8" Wide, 3/16" Shackle, 9/16" Clearance 7MK • MK#s SM171, SM66, SM68, SM70</p>  <p>Master Lock.</p>
<p>45 SERIES M1 Cylinder, Carded 1-1/8" Wide, 3/16" Shackle, 3/4" Clearance 45/30C • Carded</p>  <p>ABUS 45/30 1 1/8" width</p>	<p>45 SERIES M1 Cylinder 1-1/2" Wide, 1/4" Shackle, 7/8" Clearance 45/40C • Carded 45HB/40C • Carded • 2-1/4" Clearance</p>  <p>ABUS 45/40C 1 1/2" width 45HB/40C 2 1/4" width</p>	<p>45 SERIES M1 Cylinder 1-3/4" Wide, 5/16" Shackle, 15/16" Clearance 45/45C • Carded 45/45KA-1</p>  <p>ABUS 45/45C 1 3/4" width</p>	<p>45 SERIES M1 Cylinder 2" Wide, 11/32" Shackle, 1" Clearance 45/50C • Carded</p>  <p>ABUS 45/50C 2" width</p>
<p>#101 EXTRA REACH Rekeyable, 5-Pin W27 Cylinder 3-1/4" Wide, 5/16" Shackle, 3" Clearance 101KD 101KA-10L001</p>  <p>Master Lock.</p>	<p>#81 MASTER PADLOCK Non-Rekeyable, 5-Pin W81 Cylinder 1-3/4" Wide, 5/16" Shackle, 15/16" Clearance 81KA-10L001</p>  <p>Master Lock.</p>	<p>#37 ARMOR LOCK Non-Rekeyable, 4-Pin W1 Cylinder 1-9/16" Wide, 9/32"-1/2" Shackle, 15/16" Clearance 37D • Carded 37KA-3331</p>  <p>Master Lock.</p>	<p>#312 BLUE COVER Non-Rekeyable, 4-Pin W1 Cylinder 1-9/16" Wide, 3/8" Shackle, 3/4" Clearance 312D • Carded 312D-LH • 2" Clearance</p>  <p>Master Lock.</p>
<p>#1 MASTER SHROUDED Non-Rekeyable, 4-Pin W1 Cylinder 1-3/4" Wide, 5/16" Shackle, 15/16" Clearance 1DEX</p>  <p>Master Lock.</p>	<p>#1 MASTER SHROUDED Non-Rekeyable, 4-Pin W1 Cylinder 1-9/16" Wide, 9/32" Shackle, 3/4" Clearance 3DEX</p>  <p>Master Lock.</p>	<p>#7 MASTER SHROUDED Non-Rekeyable, 4-Pin W7 Cylinder 1-1/8" Wide, 3/16" Shackle, 9/16" Clearance DEX7</p>  <p>Master Lock.</p>	<p>#443 SINGLE POST Non-Rekeyable, 4-Pin W1 Cylinder 1-9/16" Wide, 3/8" Shackle, 5/8" Clearance 443KA 443KA-LE • 7/8" Clearance 443KA-LK • 3-1/2" Clearance • KA#s 3210</p>  <p>Master Lock.</p>
<p>#2 MASTER PADLOCK Non-Rekeyable, 4-Pin W1 Cylinder 1-3/4" Wide, 5/16" Shackle, 15/16" Clearance 2D • Carded 2KA • KA#s 2206, 2357</p>  <p>Master Lock.</p>	<p>#4 MASTER PADLOCK Non-Rekeyable, 4-Pin W1 Cylinder 1-9/16" Wide, 9/32" Shackle, 3/4" Clearance 4D • Carded 4KA • KA#s 3252, 3476, 3595 4LFKA-3595 • 1-1/2" Clearance</p>  <p>Master Lock.</p>	<p>#6 MASTER PADLOCK Non-Rekeyable, 4-Pin W1 Cylinder 2" Wide, 3/8" Shackle, 1" Clearance 6D • Carded 6KA • KA#s A298, A482, A795</p>  <p>Master Lock.</p>	<p>#6 MASTER PADLOCK Non-Rekeyable, 4-Pin W1 Cylinder 1-1/8" Wide, 3/16" Shackle, 1-2" Clearance 8D • Carded 8KA-P503</p>  <p>Master Lock.</p>

Warded Padlocks

#105 MASTER PADLOCK

Warded, Non-Rekeyable
1-1/8" Wide, 3/16" Shackle, 1/2" Clearance
105D
• Carded
105KA-075



Master Lock.

#10 MASTER PADLOCK

Warded, Non-Rekeyable
1" Wide, 5/32" Shackle, 7/16" Clearance
10D
• Carded
10KA-L23



Master Lock.

#22 MASTER PADLOCK

Warded, Non-Rekeyable
1-1/2" Wide, 1/4" Shackle, 5/8" Clearance
22D
• Carded
22KA
• KA#'s 280,336,337



Master Lock.

#500 MASTER PADLOCK

Warded, Non-Rekeyable
1-3/4" Wide, 9/32" Shackle, 13/16" Clearance
500D
• Carded
500KA
• KA#'s 255,370



Master Lock.

#510 MASTER PADLOCK

Warded, Non-Rekeyable
1-3/4" Wide, 9/32" Shackle, 5/8-2" Clearance
510D
• Carded



Master Lock.

#517 MASTER PADLOCK

Warded, Non-Rekeyable
1-3/4" Wide, 9/32" Shackle, 2-3/4"-5-3/8" Clearance
517D
• Carded
517KA-F29



Master Lock.

#9 MASTER PADLOCK

Warded, Non-Rekeyable
3/4" Wide, 1/8" Shackle, 5/16" Clearance
9D
• Carded



Master Lock.

#500 BREAK-A-WAY

Warded, Non-Rekeyable
1-3/4" Wide, 9/32" Shackle, 13/16" Clearance
500BRK-KA179



Master Lock.

Weather Resistive

WEATHER TOUGH

5-Pin W6000 Cylinder
2-1/8" Wide, 5/16" Shackle, 2-1/2" Clearance
6121LJ-KA
• KA# 10G001
6121LJ-KZ
• Zero-Bitted



Master Lock.

PRO SERIES REKEYABLE PADLOCKS - WEATHER TOUGH

PRO SERIES 6121

5-Pin W6000 Cylinder
2-1/8" Wide, 5/16" Shackle, 1-1/8" Clearance
6121D
• Carded
6121KA
KA#'s 10G001, 10G002
6121KZ
• Zero-Bitted
6121KZW1
• Zero-Bitted, W1 Cylinder
6121WO
• W/O Cylinder



Master Lock.

PRO SERIES 6125

5-Pin W6000 Cylinder
2-3/8" Wide, 3/8" Shackle, 1-3/8" Clearance
6125KD
6125KA
KA#'s 10G001, 10G002
6125KZ
• Zero-Bitted
6125KZW1
• Zero-Bitted, W1 Cylinder
6125WO
• W/O Cylinder



PRO SERIES 6127

5-Pin W6000 Cylinder
2-5/8" Wide, 7/16" Shackle, 1-3/8" Clearance
6127KD
6127KA
KA#'s 10G001, 10G002
6127KZ
• Zero-Bitted
6127WO
• W/O Cylinder

WHY PRO SERIES?

- Removable Cylinder can be replaced or repinned
- Protected by water, dirt & grime
- Dual ball bearing locking to resist pulling & prying

WEATHER TOUGH

5-Pin W6000 Cylinder
2-5/8" Wide, 7/16" Shackle, 1-3/8" Clearance
6127LJ-KA
• KA# 10G003



Master Lock.

WEATHERBUILT

Rekeyable 5-Pin APTC12 Cylinder
1-3/4" Wide, 5/16" Shackle, 1-1/8" Clearance
A5200-COV
• KA# 22548



WEATHERBUILT

Rekeyable 5-Pin APTC12 Cylinder
2" Wide, 3/8" Shackle, 1-1/8" Clearance
A5260-COV
• KA# 24767



CAR KEY PADLOCK

Access your car and padlock with the same key!
7017417
• GM B89 KWY
7017418
• GM B106 KWY
7017419
• Ford H75 KWY
7017420
• Chrysler Y159 KWY



SHROUDED SHACKLE

Rekeyable 6-Pin APT748 Cylinder
2-1/2" Wide, 7/16" Shackle, 1" Clearance
A748



High Security

DISKUS 20 SERIES

Abus 6 Disc Plus Cylinder
70mm Wide, 10mm Shackle, 17mm Clearance
20/70B



DISKUS 24 SERIES

High Security
60mm Wide, 8mm Shackle, 13mm Clearance
24/60C
• Carded
24/60KA
• KA# 0113, 0121, 0123



DISCUS 24 SERIES

High Security
91mm Wide, 10mm Shackle, 17mm Clearance
24/70C
• Carded
24/70KA
• KA# 0121, 0123, 0198
24/70RK
• Rekeyable
• 71mm Wide



DISCUS 26 SERIES

High Security
26/70KA
• 71mm Wide, 10mm Shackle, 17mm Clearance
• KA# 0113
26/90C
26/90KA
• 91mm Wide, 12mm Shackle, 16mm Clearance
• KA# 0131



PRO SERIES REKEYABLE PADLOCKS - SOLID STEEL

5-Pin W6000 Cylinder
2-1/2" Wide, 7/16" Shackle, 1-1/8" Clearance
6230D
• Carded
6230KA
KA#s 10G001, 10G002, 10G011
6230KZ
• Zero-Bitted
6230KZW1
• Zero-Bitted, W1 Cylinder
6230WO
• W/O Cylinder

5-Pin W6000 Cylinder
2-1/2" Wide, 7/16" Shackle, 2" Clearance
6230DLH
• Carded



Master Lock.

DISKUS 28 SERIES

High Security
71mm Wide, 10mm Shackle, 17mm Clearance
28/70C
• Carded
28/70KA
• KA#s 0010, 0027, 0028



ABUS

PRO SERIES ROUND

Rekeyable, 6-Pin W7000 Cylinder
2-7/8" Wide, (A) 3/8", (B) 1-9/32", (C) 1-23/32"
6270
6270
• KA#s 10G001, 10G002



Master Lock.

DISKUS 28 SERIES

High Security
60mm Wide, 8mm Shackle, 13mm Clearance
28/60C
• Carded
28/60KA
• KA# 0028



ABUS

ROUND HIDDEN SHACKLE

Rekeyable, 6-Pin APT2001 Cylinder
2-7/8" Wide, (A) 3/8", (B) 1-9/32", (C) 1-23/32"
A2000D
A2000KA
• KA#s 80040, 80050
A2000KD



AMERICAN LOCK
INDUSTRIAL GRADE SECURITY

PRO SERIES REKEYABLE PADLOCKS - HIGH SECURITY

PRO SERIES 6321

5-Pin W6000 Cylinder
2-1/8" Wide, 5/16" Shackle, 3/4" Clearance
6321KD
6321D
• Carded
6321KA
KA#s 10G001, 10G002
6321KZW1
• Zero-Bitted, W1 Cylinder
6321WO
• W/O Cylinder



PRO SERIES 6325

5-Pin W6000 Cylinder
2-3/8" Wide, 3/8" Shackle, 3/4" Clearance
6325KD
6325KA
KA#s 10G001, 10G002
6325KZ
• Zero-Bitted
6325KZW1
• Zero-Bitted, W1 Cylinder
6325WO
• W/O Cylinder



PRO SERIES 6327

5-Pin W6000 Cylinder
2-5/8" Wide, 7/16" Shackle, 3/4" Clearance
6327KD
6327KA
KA#s 10G001, 10G002
6327KZW1
• Zero-Bitted, W1 Cylinder
6327WO
• W/O Cylinder

WHY PRO SERIES?

- Removable Cylinder can be replaced or repinned
- Protected by water, dirt & grime
- Dual ball bearing locking to resist pulling & prying

Master Lock.

ROUND HIDDEN SHACKLE

Rekeyable, 6-Pin APTC14 Cylinder
2-7/8" Wide, (A) 3/8", (B) 1-9/32", (C) 1-23/32"
A2500D



AMERICAN LOCK
INDUSTRIAL GRADE SECURITY

HIGH SECURITY HASP

For A2000 Padlock
A800
• Length: 9-1/16"



AMERICAN LOCK
INDUSTRIAL GRADE SECURITY

STEEL DISKUS HASP

Haps for Discus, Carded
140-120C
• Size: 120 x 56 mm
140-190C
• Size: 190 x 56 mm



ABUS

STEEL UTILITY HASP

200-115
• Size: 116 x 47 mm
200-135
• Size: 138 x 47 mm
200-155
• Size: 157 x 47 mm
200-95
• Size: 97 x 39 mm
200-75
• Size: 75 x 29 mm



ABUS

STEEL FLEX HASP

Hardened Staple, Carded
110-155C
• Size: 155 x 45 mm
110-195C
• Size: 195 x 45 mm
110-230C
• Size: 230 x 45 mm



ABUS

HIGH SECURITY HASP

For 6270 Padlock
770
• Length: 9 x 4-1/2"



Master Lock.

HEAVY DUTY HASP

High Security, Carded
A875D
• Length: 6-1/4"
• Single Hinge
A885D
• Length: 7-3/4"
• Double Hinge



AMERICAN LOCK
INDUSTRIAL GRADE SECURITY

HEAVY DUTY HASP

High Security, Carded
A535D
• Length: 5"
• Center Hole



AMERICAN LOCK
INDUSTRIAL GRADE SECURITY

HASP W/ PADLOCK

High Security Hasp and Chrome Plated, Solid Steel Lock Body
A2500LHC1
• A801 Hasp w/ A2500 Padlock



AMERICAN LOCK
INDUSTRIAL GRADE SECURITY

HASP W/ PADLOCK

Carded, Hidden Shackle Padlock with Hasp
A800LHCD
• A800 Hasp w/ A2000 Padlock



AMERICAN LOCK
INDUSTRIAL GRADE SECURITY

Hasps

LOCKING BOLT

Heavy-duty high security locking bolt has a 3/4" square solid hardened steel throw that is fully adjustable from 3/4" to 2 3/8"
A895D
 • Length: 8-1/2"



HASPLOCK

4-Pin Tumbler
 Size: 4-1/2" x 1-2/4"
475KD
475KA
450D
 • Carded



Master Lock.

UTILITY HASP

Carded
702D
 • Length: 2-1/2"
703D
 • Length: 3-1/2"
704D
 • Length: 4-1/2"
706D
 • Length: 6"



Master Lock.

HEAVY DUTY HASP

High Security, Carded
A825D
 • Length: 7-1/4"
 • Straight Bar
A850D
 • Length: 4-1/4"
 • 90 Degree Angle Bar



HINGED HASPS

Carded
720DPF
 • Single Hinge
 • Length: 6-1/4"
721DPF
 • Single Hinge
 • Length: 8"
722DPF
 • Double Hinge
 • Length: 7-3/4"



Master Lock.

PADLOCK EYES

Accepts Shackle Diameter up to 1/2"
 2 PCK
60
 • Flat Orientation
60R
 • Right Angle Flat Orientation



Master Lock.

HASP LOCK

Size: 4-1/2" x 1-1/2"
ELK-110-KD
ELK-110-KA
 • For in-opening doors
 • Left or right handed doors

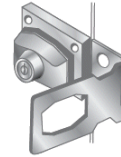

HASP LOCK

Size: 2-1/2" x 2-3/4"
ELK-111-KD
ELK-111-KA
 • Use on doors, gates, trunks, or boxes

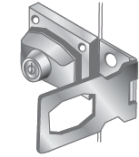

SMALL FORMAT I/C CORE - WEATHER TOUGH

PRO SERIES 6421

Small Format I/C Lock W/O Cylinder
 2-1/8" Wide, 5/16" Shackle, 1-1/8" Clearance
6421WO

PRO SERIES 6427

Small Format I/C Lock W/O Cylinder
 2-5/8" Wide, 7/16" Shackle, 1-3/8" Clearance
6427WO
6427LH-WO
 • 1-7/8" Clearance



Master Lock.

SMALL FORMAT I/C CORE - HIGH SECURITY

PRO SERIES 6521

Small Format I/C Lock W/O Cylinder
 2-1/8" Wide, 5/16" Shackle, 3/4" Clearance
6521WO

PRO SERIES 6527

Small Format I/C Lock W/O Cylinder
 2-5/8" Wide, 7/16" Shackle, 3/4" Clearance
6527WO



Master Lock.

SMALL FORMAT I/C CORE

Pro Series I/C Lock W/O Cylinder
 1-9/16" Wide, 1/4" Shackle, 1-1/16" Clearance
6831WO
 • KA# 10G001
6831LF-WO
 • 1-9/16" Clearance



Master Lock.

SMALL FORMAT I/C CORE

Pro Series I/C Lock W/O Cylinder
 1-3/4" Wide, 5/16" Shackle, 1-3/16" Clearance
6841WO



Master Lock.

SMALL FORMAT I/C CORE

Pro Series I/C Lock W/O Cylinder
 1-3/4" Wide, 5/16" Shackle, 1-3/16" Clearance
7041WO



Master Lock.

SMALL FORMAT I/C CORE

Small Format I/C Lock W/O Cylinder
 1-3/4" Wide, 5/16" Shackle, 1-1/8" Clearance
A3200WO



SMALL FORMAT I/C CORE

Small Format I/C Lock W/O Cylinder
 2" Wide, 3/8" Shackle, 1-1/8" Clearance
A3260WO



SMALL FORMAT I/C CORE

Small Format I/C Lock W/O Cylinder
 1-3/4" Wide, 5/16" Shackle, 1-1/8" Clearance
A3560WO



SMALL FORMAT I/C CORE

Small Format I/C Lock W/O Cylinder
 47mm Wide, 8mm Shackle, 25mm Clearance
831C/45



LARGE FORMAT I/C CORE

Large Format I/C Lock W/O Cylinder
 2" Wide, 3/8" Shackle, 1-1/8" Clearance
A3900S-WO
A3901S-WO
 • 2" Clearance



I/C Core Padlocks

LARGE FORMAT I/C CORE

Large Format I/C Lock W/O Cylinder
2" Wide, 3/8" Shackle, 1-1/2" Clearance
KS43D3200



REKEYABLE LESS CYL

Need 83 Series 2 Drivers to work cylinder.
47mm Wide, 8mm Shackle, 25mm Clearance
83/45-S2
• W/O Cylinder
83209H
• Bible Cover & 3 Drivers
• Accepts Schlage & Primus, Medeco, Lori/Sargent



REKEYABLE PADLOCKS - SCH, KWI, YALE, WEISER

SERIES 83/45

47mm Wide, 8mm Shackle, 25mm Clearance
83/45-100
• Yale Rekeyable
83/45-200
• Kwikset Rekeyable
83/45-300
• Schlage C Rekeyable
83/45-3000
• Schlage C-K Rekeyable
83/45-323
• Schlage Everest C123 Rekeyable
83/45-345
• Schlage Everest C145 Rekeyable
83/45-800
• Weiser Rekeyable

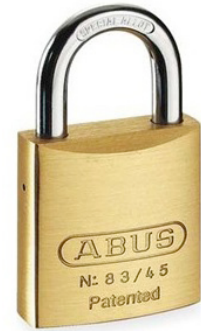

REKEYABLE PADLOCK

55mm Wide, 11mm Shackle, 37mm Clearance
83/55-200
• Kwikset Rekeyable
83/55-300
• Schlage C Rekeyable



REKEYABLE PADLOCK

Shrouded
47mm Wide, 8mm Shackle, 26mm Clearance
83CS/45-3000
• Schlage C-K Rekeyable



REKEYABLE PADLOCK

Zero-Bitted
1-3/4" Wide, 5/16" Shackle, 1-1/8" Clearance
A3600S-KZ
• Schlage C Rekeyable
A3600K-KZ
• Kwikset Rekeyable



REKEYABLE LESS CYL

Accepts 6 pin cylinders from Schlage, Medeco, Assa, or Lori. Need adapter driver to work cylinder.
1-3/4" Wide, 5/16" Shackle, 1-1/8" Clearance
A3600-WO
A3601-WO
• 2" Clearance
ADRSCH6
• 6/BG Schlage Drivers
ADMED6
• 6/BG Medeco Drivers



REKEYABLE PADLOCK

Zero-Bitted
2" Wide, 3/8" Shackle, 1-1/8" Clearance
A3700S-KZ
• Schlage C Rekeyable



REKEYABLE LESS CYL

W/O Cylinder. Need adapter driver to work cylinder.
2-1/8" Wide, 5/16" Shackle, 1-1/8" Clearance
6621WO
6621LJ-WO
• 2-1/2" Clearance



Master Lock.

REKEYABLE LESS CYL

W/O Cylinder. Need adapter driver to work cylinder.
2-5/8" Wide, 7/16" Shackle, 1-3/8" Clearance
6627WO
6627LH-WO
• 1-7/8" Clearance



Master Lock.

REKEYABLE LESS CYL

W/O Cylinder. Need adapter driver to work cylinder.
6721WO
• 2-1/8" Wide, 5/16" Shackle, 3/4" Clearance
6727-WO
• 2-5/8" Wide, 7/16" Shackle, 3/4" Clearance



Master Lock.

ADAPTER DRIVERS

Adaptor Drivers for Master Padlocks.
298-0626
• 6/PK Lori Drivers
298-0627
• 6/PK Medeco Drivers
298-0628
• 6/PK Schlage Drivers



Master Lock.

REKEYABLE PADLOCK

Zero-Bitted
1-3/4" Wide, 5/16" Shackle, 1-3/16" Clearance
6842D035-KZ
• Y1 Kwy
6842D045-KZ
• SC1 Kwy
6842D125-KZ
• KW1 Kwy



Master Lock.

REKEYABLE PADLOCK

Zero-Bitted
2" Wide, 3/8" Shackle, 1-1/2" Clearance
6852D045-KZ
• SC1 Kwy
6852WO
• W/O Cylinder
• Need adapter driver to work cylinder



Master Lock.

REKEYABLE LESS CYL

1-3/4" Wide, 5/16" Shackle, 1-3/16" Clearance
7042WO
• W/O Cylinder



Master Lock.

KS SERIES REKEYABLE PADLOCKS

1-3/4" Wide, 5/16" Shackle
KS23D2200
• 1-1/2" Clearance
• Less Cylinder
KS23D2300
• 1-1/2" Clearance
• Schlage C Kwy
KS23F2200
• 2" Clearance
• Less Cylinder
KS23F2300
• 2" Clearance
• Schlage C Kwy



2" Wide, 3/8" Shackle
KS43D2200
• 1-1/2" Clearance
• Less Cylinder
KS43D2300
• 1-1/2" Clearance
• Schlage C Kwy
KS43F2200
• 2" Clearance
• Less Cylinder
KS43F2300
• 2" Clearance
• Schlage C Kwy



REKEYABLE PADLOCK

1-3/4" Wide, 5/16" Shackle, 1-3/16" Clearance
7047D045-KZ
• SC1 Kwy
• Shrouded



Master Lock.























RECODABLE PADLOCK

Rekey locks in as little as 15 seconds, as often as needed. Match your recodable padlock to your D12 Kwikset® door key. Eliminates the need for entire lock replacement
2" Wide, 3/8" Shackle, 1-1/2" Clearance
7053
7053LJ
• 2-1/2" Clearance



Master Lock.

<p>RESETTABLE COMBO 42mm Wide, 6mm Shackle, 22mm Clearance 160/40C</p> <ul style="list-style-type: none"> • Self Locking Bolted Shackle • Polished Chrome Body & Shackle  <p>ABUS</p>	<p>RESETTABLE COMBO 50mm Wide, 7.5mm Shackle, 26mm Clearance 160/50C</p> <ul style="list-style-type: none"> • Self Locking Bolted Shackle • Polished Chrome Body & Shackle  <p>ABUS</p>	<p>180 SERIES 53mm Wide, 8mm Shackle, 25mm Clearance 180/50C</p> <ul style="list-style-type: none"> • All-Weather Padlock • Stainless-steel shackle • 10,000 possible combinations • Resetting tool included  <p>ABUS</p>	<p>180 SERIES 53mm Wide, 8mm Shackle, 63mm Clearance 180/HB/50C</p> <ul style="list-style-type: none"> • All-Weather Padlock • Stainless-steel shackle • 10,000 possible combinations • Resetting tool included  <p>ABUS</p>
<p>CABLE GUN LOCK Carded 0.22" Diameter, 14" Length 107KADSPT</p> <ul style="list-style-type: none"> • California Approved • Braided Steel Cable • Usable on revolvers, pistols, rifles and shotguns  <p>Master Lock.</p>	<p>PRO SERIES Carded, Resettable Combination 2-1/4" Wide, 5/16" Shackle, 1-1/16" Clearance 1174D</p> <ul style="list-style-type: none"> • ProSeries® resettable designed for Commercial/Industrial applications • Set-your-own 4-digit combination; 10,000 possible combinations • No reset tool required  <p>Master Lock.</p>	<p>PRO SERIES Carded, Resettable Combination 2-1/4" Wide, 3/8" Shackle, 1-1/16" Clearance 1175D 1175DLH</p> <ul style="list-style-type: none"> • 2-1/16" Clearance  <p>Master Lock.</p>	<p>DIE CAST PRO SERIES Carded, Resettable Combination 2-1/4" Wide, 3/8" Shackle, 1-1/16" Clearance 1178D</p> <ul style="list-style-type: none"> • ProSeries® resettable designed for Commercial/Industrial applications • Octagonal boron-carbide shackle for additional security  <p>Master Lock.</p>
<p>DIAL COMBINATIONS PADLOCKS 1-7/8" Wide, 9/32" Shackle, 3/4" Clearance</p> <p>1500D</p> <ul style="list-style-type: none"> • Carded <p>1500KA</p> <ul style="list-style-type: none"> • KA# 903856 <p>1500T</p> <ul style="list-style-type: none"> • 2/CD Keyed Alike  <p>Master Lock.</p>	<p>Colored Dial Padlocks, Carded</p> <p>1504D</p> <ul style="list-style-type: none"> • Red <p>1506D</p> <ul style="list-style-type: none"> • Blue  <p>Adjustable Length Shackle, Carded</p> <p>1517D</p> <ul style="list-style-type: none"> • 4-1/2" to 4-3/4" Clearance  <p>Master Lock.</p>	<p>36" CABLE LOCK Steel Cable with protective Vinyl Sleeve 1-7/8" Wide, 36" Length, 3/16" Diameter 1519D</p> <ul style="list-style-type: none"> • KA# 10G001  <p>Master Lock.</p>	<p>SPEED DIAL 2" Wide, 1/4" Shackle, 1" Clearance 1500ID</p> <ul style="list-style-type: none"> • Combo lock that opens on up/down/left/right • Faster and easier than a standard combo lock • Resettable combination  <p>Master Lock.</p>
<p>PRECISION DIAL 1-15/16" Wide, 1/4" Shackle, 7/8" Clearance 1590D</p> <ul style="list-style-type: none"> • Assortment of 4 colors per shelf pack • Set-your-own combination using 3 letters, numbers or a mix of both • Operates with familiar right-left-right combination lock movement  <p>Master Lock.</p>	<p>COMBINATION PADLOCK Set-your-own combination convenience. Resettable to any of 10,000 personalized combinations. 2" Wide, 5/16" Shackle, 1" Clearance 175D 175DLH</p>  <p>Master Lock.</p>	<p>COMBINATION PADLOCK Set-your-own combination convenience. Resettable to any of 10,000 personalized combinations. 2" Wide, 5/16" Shackle, 1" Clearance 176KA</p> <ul style="list-style-type: none"> • KA# P603 <p>176CR</p> <ul style="list-style-type: none"> • Override Key for MAS 176 KA# P603  <p>Master Lock.</p>	<p>COMBINATION PADLOCK Set-your-own combination convenience. Resettable to any of 10,000 personalized combinations. 2" Wide, 5/16" Shackle, 1" Clearance 178D</p> <ul style="list-style-type: none"> • Die-Cast Black  <p>Master Lock.</p>
<p>LOCKER PADLOCK Top of the line combination padlock! 2-3/16" Wide, 5/16" Shackle, 1" Clearance 2001</p>  <p>Master Lock.</p>	<p>LAPTOP LOCK Lock it Up! Lock it Down! Lock down laptops & portable devices with built-in lock slot for freedom to step away from belongings. 2120D</p> <ul style="list-style-type: none"> • Number Combo <p>2120DWD</p> <ul style="list-style-type: none"> • Word Combo  <p>Master Lock.</p>	<p>SET YOUR OWN COMBO 4603D</p> <ul style="list-style-type: none"> • Set-your-own combination for personalization and easy recall • Cable retraction for a tight fit around object • Vinyl coated cable to prevent scratching • Push-button retraction for easy cable recoiling  <p>Master Lock.</p>	<p>COMBINATION PADLOCK 13/16" Wide, 1/8" Shackle, 7/8" Clearance 620D</p> <ul style="list-style-type: none"> • Set-your-own combination convenience • Resettable to allow for a personalized combination  <p>Master Lock.</p>

<p>COMBINATION PADLOCK 1-3/16" Wide, 3/16" Shackle, 1" Clearance 630D • Set-your-own combination convenience • Resettable to allow for a personalized combination</p>  <p>Master Lock.</p>	<p>COMBINATION PADLOCK 2" Wide, 1/4" Shackle, 15/16" Clearance 653D • Set-your-own combination convenience • Use words, numbers, or both!</p>  <p>Master Lock.</p>	<p>TRIGGER LOCK 94DSPT • Easy to attach lock™ trigger access is blocked until lock is removed • Features positive locking with adjustable ratchet mechanism • Offers added convenience of a keyless resettable combination</p>  <p>Master Lock.</p>	<p>COMBINATION PADLOCK 4 Dial Combo. Choose from 10,000 possible combinations which can be easily changed and set. 2" Wide, 1" Clearance K436D K437D • 2-1/4" Clearance K440D • 4" Clearance</p>  <p>CCL Security Products</p>
<p>COMBINATION PADLOCK 4 Dial Combo. Choose from 10,000 possible combinations which can be easily changed and set. 2" Wide, 1" Clearance K500-3/4 K500-2-1/4 • 2-1/4" Clearance</p>  <p>CCL Security Products</p>	<p>SUPER SESAMEE COMBO 4 Dial Combo. Choose from 10,000 possible combinations which can be easily changed and set. 2-1/2" Wide, 1" Clearance K636 K637 • 2" Clearance</p>  <p>CCL Security Products</p>	<p>SHROUDED COMBO Shrouded 4 Dial Combo. Choose from 10,000 possible combinations which can be easily changed and set. 2-1/2" Wide, 1" Clearance K646</p>  <p>CCL Security Products</p>	<p>COMBINATION PADLOCK 4 Dial Combo. Choose from 10,000 possible combinations which can be easily changed and set. 2" Wide, 1" Clearance KCR0436 • Chrome KO436 • Brass Shackle</p>  <p>CCL Security Products</p>
<p>DELUXE COMBO PADLOCK 2400PG • Gold Finish • 3 number dials, 1,000 possible combinations</p>  <p>CCL Security Products</p>	<p>FORCE MINI ME U-LOCK Carded, Bike Lock 2-15/16" Wide, 1/2" Shackle, 2" Clearance 8118DPF</p>  <p>Master Lock.</p>	<p>COMBINATION CABLE Carded, Resettable Combination Bike Lock 60" Long, 3/8" Diameter 8119DPF</p>  <p>Master Lock.</p>	<p>COMBINATION CABLE Carded, Preset Combination Bike Lock, Self-Coiling 48" Long, 7/32" Diameter 8144DSG</p>  <p>Master Lock.</p>
<p>KEYED CABLE LOCK Carded, Smoke cable with Yellow Lock Body 72" Long, 3/8" Diameter 8154DPF • Ideal for bicycles, skateboards, and sports equipment • Flexible steel cables for strong cut resistance • Protective coating helps prevent scratching</p>  <p>Master Lock.</p>	<p>ALL TERRAIN U-LOCK Carded, Push button locking makes locking quick and hassle free. Double locking 7 pin tumbler for pick resistance. Vinyl-covered lock body and shackle help protect bicycle finish. 8-1/4" Wide, 9/16" Shackle, 9-1/4" Clearance 8184D</p>  <p>Master Lock.</p>	<p>CHAIN & SLEEVE Steel Alloy Body Material, Yellow Zinc Finish 2' Chain and Sleeve, 1/4" Diameter 6KS-2-CS 8KS-2-CS • 1/3" Diameter</p>  <p>ABUS</p>	<p>HEAVY DUTY CHAIN 8341 • 12" Heavy Duty Chain 8343 • 5/16" Collar for Chain</p>  <p>ABUS</p>
<p>BIG HEAVY CHAIN 5ft 6in Chain, Black Sleeve 43DPF • Hardened steel chain is reinforced with boron and titanium • Hexagonal shape increases the cross section - 30,000 Lbs. cut strength</p>  <p>Master Lock.</p>	<p>6 FT CABLE Woven steel cables for strong cut resistance. Strong loops for use with Master Lock padlocks. Protective coating helps prevent scratching. 67D • Coil 65D 68D • Multi-Wedge Loop Clamps</p>  <p>Master Lock.</p>	<p>CHAIN LOCK 3' Chain and Lock, 1-1/8" Wide Laminated Padlock 716D • Vinyl Sleeve helps prevent scratching</p>  <p>Master Lock.</p>	<p>CABLE LOCK 3' Cable, 3/16" Diameter Steel Cable 1-1/8" Wide Laminated Padlock 719D • Vinyl Sleeve helps prevent scratching</p>  <p>Master Lock.</p>
<p>PADLOCK CHAIN 9" Padlock Chain 71CH • Heavy-Duty 71CS • Lightweight</p>  <p>Master Lock.</p>	<p>SHACKLE COLLAR 71SC10 • #1, 21, 81, 175 71SC12 • #5, 25, 29 71SC14 • #15, 17, 220, 230, 27 71SC17 • #19</p>  <p>Master Lock.</p>	<p>SHACKLE COLLAR 71SC7 • #7, 105 71SC8 • #22, 77 71SC9 • #3, 500, 1500</p>  <p>Master Lock.</p>	<p>CHAIN & SLEEVE 3' Chain & Sleeve 73D • Case-hardened steel chain for maximum cut resistance • Welded links for superior pry resistance • Protective vinyl sleeves help prevent scratching</p>  <p>Master Lock.</p>

Combination/Resettables

Bike Locks

Cables & Chains

Cables & Chains

Luggage & TSA

School Locker Locks

Keying Kit

HEAVY CABLE

6' Heaby Cable, 3/8" Diameter
78DPF
 • Black vinyl coating helps prevent scratching
 • Convenient loops with rust-resistant sleeves and scratch guards
 • Recommended use with laminated, solid steel and mini U-Locks



Master Lock.

WORD COMBO CABLE

Work Combo Cable Lock for Bikes
8152DASTWD

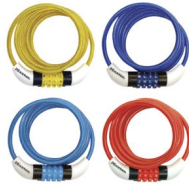

Master Lock.

ARMORED CABLE

6' Heaby Cable, 13/16" Diameter
8218DPS
 • High security disk cylinder
 • Hardened steel sleeve resists cutting and sawing
 • Vinyl coated to prevent scratches



Master Lock.

KRYPTONITE CABLE

6' Heaby Cable, 5/8" Diameter
8218DPS
 • Braided Steel Vinyl Coated Cable Provides Greater Cut Resistance Than Twisted Cable
 • Rekeyable To Your Existing Standard Schlage SC-1 Key



SCHLAGE

TSA TRAVEL PADLOCK

1-1/4" Wide
4680D
 • Black or Nickel



Master Lock.

TSA LUGGAGE PADLOCK

TSA-Accepted luggage lock - ideal for air travel.
 1-1/4" Wide
4681T
 • Keyed alike twin pack
 • Assortment of 2 blue sets & 2 red sets per shelf pack



Master Lock.

TSA LOCKING STRAP

78" Strap
4682D
 • Black
 • 7/8" webbed strap is adjustable for flexibility
 • Set-your-own combination convenience



Master Lock.

TSA PADLOCK

7/8" Width, Solid Brass Body
4683Q
 • 4 Pack, TSA Accepted Luggage Locks Are KA
 • Allows Screeners To Inspect & Relock Bags Without Damaging The Lock



Master Lock.

TSA COMBO LOCK

1-1/2" Wide, TSA Set Your Own Combination
4685D
 • Black or 2 Blue & 2 Red in a box of 4
 • Personal ID area on back of lock
 • 3 dial, set-your-own combination convenience
 • Unique side window for easy combination viewing



Master Lock.

TSA PADLOCKS

1" wide body, 1/8" Shackle, 9/16" Clearance
4689Q
 • Blue, Purple, Pink, Silver
 • 4/PK Matching keyed alike locks



Master Lock.

TSA COMBO LOCK

Set-your-own combination convenience, Resetttable to allow for a personalized combination
 13/16" Wide, TSA Set Your Own Combination
646D
 • Carded
646T
 • 2/PK



Master Lock.

TSA COMBO LOCK

Set-your-own combination convenience, Resetttable to allow for a personalized combination
 1-3/16" Wide, TSA Set Your Own Combination
647D
 • Carded



Master Lock.

TSA LOOPED SHACKLE

Combination lock designed with a security feature allowing TSA agents the ability to open the SearchAlert lock without destroying the lock.
K6435PSB



CCP
 Security Products

TSA SEARCH-ALERT™

Combination lock designed with a security feature allowing TSA agents the ability to open the SearchAlert lock without destroying the lock.
K7400PSB
 • 1-1/8" Wide



CCP
 Security Products

LOCKER PADLOCK

Easy, dependable 3-number dialing with automatic scrambling feature to prevent reopening of lock.
1525LF-V65
 • 1 1/2" Shackle



Master Lock.

LOCKER PADLOCK

Easy, dependable 3-number dialing with automatic scrambling feature to prevent reopening of lock.
1525-V625
 • 3/4" Shackle
CONTROL-V625
 • Control Key



Master Lock.

LOCKER PADLOCK

Easy, dependable 3-number dialing with automatic scrambling feature to prevent reopening of lock.
1525-V652
 • 3/4" Shackle
CONTROL-V652
 • Control Key



Master Lock.

BUILT IN LOCKER COMBO

End user registration and control charts provided to secure and simplify administration. Secure, easy-to-dial three digit combination. Easily changed with the touch of a button.
1630-F120



Master Lock.

BUILT IN LOCKER COMBO

End user registration and control charts provided to secure and simplify administration. Secure, easy-to-dial three digit combination. Easily changed with the touch of a button.
1630-F344
 • Right Hand
1631-F344
 • Left Hand
K1630-F344
 • Control Key



Master Lock.

BUILT IN LOCKER COMBO

High security, 5 pin tumbler cylinder for superior pick resistance. Easy to install; designed to fit most lockers. Two keys provided per each lock.
1710KD
 • Keyed different
1710MK
 • Master Keyed
KEY-SL14
 • Master Key



Master Lock.

PIN KIT

APK-1
 • 100/EA Bottom Pins 1-8
 • 100/EA Top Pins
 • 10/EA Driver Springs
 • 5/EA Security Screws
 • 5/EA Security Nuts



AMERICAN LOCK
 INDUSTRIAL GRADE SECURITY

PADLOCK SERVICE KIT

ASK-8
 (100)Bottom pins 1-8 (100)Master pins 2-7 (100) Top pins (100)Driver springs (12)A5000 series ball bearings (12)A700 series ball bearings (25)Security screws (25)Security nuts (2)Trap doors for A700 series locks (4)Trap doors for A5000 series locks (1)American Lock Co. 6 pin cylinder (2)Actuators for A700 series locks (4)Actuators for A5000 series locks (1)American Lock Co. 5 pin cylinder (10)Snap rings (1)Follower tool

AMERICAN LOCK
 INDUSTRIAL GRADE SECURITY

TUBULAR SERVICE KIT

ATCR3
 • 100/EA Key pins
 • 100/EA Driver pins
 • 100/EA Springs
 • 10/EA 180° Stop plates
 • 10/EA 90° Stop plates
 • 1/EA Shell
 • 1/EA ATRT-1 rekeying tool
 • 1/EA Depth key

























AMERICAN LOCK
 INDUSTRIAL GRADE SECURITY

BUILT IN LOCKER COMBO

Contains assortment of the most frequently used pins and service components. Deep storage compartments and sealing cover keeps to parts in their place. Convenient reference chart included. Rekeying part refills may be ordered separately
291



Master Lock.

<p>COUPLER LOCK Coupler Lock, 3 1/2" Length, 9/32" Diameter 1471DAT • Precision pin tumbler mechanism resists picking</p>  <p>Master Lock.</p>	<p>RECIIEVER LOCK Receiver Lock, 2-1/2" 1473DAT • Hardened pins for increased shee strength • Precision 4-pin tumbler mechanism resists picking • Key retaining for increased safety • K1 key blank for all receiver locks • Available Keyed Alike</p>  <p>Master Lock.</p>	<p>RECIIEVER LOCK Fits Both 5/8" & 1/2" Receiver Holes 1480DAT • KD • Hardened pins for increased sheer strength. • Precision 4-pin tumbler mechanism resists picking. • Key retaining for increased safety. • K1 key blank for all receiver locks.</p>  <p>Master Lock.</p>	<p>RECIIEVER & COUPLER Stainless Receiver and Coupler Locks # 1480DAT & 2847DAT 1481DATSC • Keyed alike convenience • Weather Tough® seal resists corrosion • K1 key blank</p>  <p>Master Lock.</p>
<p>SPARE TIRE LOCK Locks over wheel studs up to 9/16" Diameter 262DAT • Solid zinc and steel construction • Chrome plated for corrosion resistance • For use only on non-operating spare tire • NO additional Key Blanks are available, keyway is unknown</p>  <p>Master Lock.</p>	<p>ADJUSTABLE COUPLER 2847DATSC • Stainless Steel, Adjustable Coupler Latch Lock • Precision pin tumbler mechanism resists picking</p>  <p>Master Lock.</p>	<p>RECIIEVER & COUPLER Reciever Hitch & Adjustable Coupler Latch 2848DATSC • KA • Uses K1 key blank</p>  <p>Master Lock.</p>	<p>RECIIEVER W/ SWIVEL Reciever Lock With Swivel Head Fits both 1/2" and 5/8" receivers 2866DAT • Swivel head design allows for easy access • Ideal for tight receivers applications • Stainless steel sleeve</p>  <p>Master Lock.</p>
<p>TRAILER LOCK Protect unattended trailers. Rugged die-cast zinc body resists corrosion. 4-pin tumbler cylinder helps prevent picking. Fits most 2" (51mm) couplers 34 35 • Marvel 36 • Hadoo</p>  <p>Master Lock.</p>	<p>HITCH LOCK Class III/IV Hitch Lock, 5/8" 997EB 375DAT • Hardened receiver pins for increased shear strength • Precision pin tumbler mechanism resists picking</p>  <p>Master Lock.</p>	<p>UNIVERSAL COUPLER Fits 1-7/8" & 2" Couplers 377DAT 377KA-0313 • Universal Coupler Lock • Adjusts to fit many makes and models • Uses No. 1 key blank</p>  <p>Master Lock.</p>	<p>UNIVERSAL COUPLER Fits 2-5/16" Couplers 378DAT • Adjustable Coupler Lock • Adjusts to fit many makes and models • Uses No. 1 key blank</p>  <p>Master Lock.</p>
<p>UNIVERSAL COUPLER Fits 1-7/8", 2", and 2-5/16" couplers manufactured by Reese®, Fulton, Valley, Atwood®, Shelby, Putnam, Hammerblow, Dutton Lainson, and UFP. 379DAT</p>  <p>Master Lock.</p>	<p>KING PIN LOCK Solid, cast aluminum alloy withstands physical attacks. Bright red finish and red flag are visible to the driver from a distance. Lock, protected by the housing, resists common physical attacks. 387</p>  <p>Master Lock.</p>	<p>COUPLER/TRAILER LOCK 605DAT • 2" Solid brass body • Case hardened steel shackle • Lock design protects shackle from cutting and sawing • Precision pin tumbler mechanism resists picking</p>  <p>Master Lock.</p>	<p>FUSION PADLOCK 1-3/16" Wide, Polish Chrome or Satin Nickel 196D • Carded 196T • Twin Pack</p>  <p>Master Lock.</p>
<p>FUSION PADLOCK 1-3/16" Wide, Polish Chrome or Satin Nickel 197D 198D • 2" Body</p>  <p>Master Lock.</p>	<p>SPHERO SMOOTH SPIN Dome dial shape with a slick, metallic finish in teens favorite colors. An easy-to-grip fun-to-turn, smooth spinning dial. Combination security for keyless convenience. Strong, metal construction for durability 2075DAST</p>  <p>Master Lock.</p>	<p>SECURITY BAR For hinged and sliding doors. Top piece removes for sliding door application. Adjusts to fit most standard doors. Rugged 20 gauge steel construction. Pivoting ball joint assures full contact with floor. Padded foot provides sure grip without scratching. 265DCCSEN</p>  <p>Master Lock.</p>	<p>SAFETY LOCKOUT Heavy gauge steel resists prying. Each hasp allows for lockout by up to 6 workers. 420 • 1" Diameter Jaws 421 • 1-1/2" Diameter Jaws</p>  <p>Master Lock.</p>
<p>ELECTRIC PLUG LOCKOUT Heavy gauge steel resists prying. Each hasp allows for lockout by up to 6 workers. 428 • Isolate Equipment from Power Sources • Device slides over plug prongs and locks in place • Cannot be removed without the key • Fits 2 and 3-prong, 110 volt plugs</p>  <p>Master Lock.</p>	<p>LOCK ANCHORS Used with Master locks and cables the anchor effectively locks equipment to a solid wall, stud, or floor anchoring point. 8222D • 2/PK</p>  <p>Master Lock.</p>	<p>DISC BRAKE LOCK Sleek, circular chrome-plated disc brake lock prevents roll-away theft. 1" Throat with a 3/16" Shackle. 8222D • Easy push button locking system</p>  <p>Master Lock.</p>	<p>DISC BRAKE LOCK Disc brake lock with reminder cord. Prevent Roll-Away Theft. Easy Push Button Locking System with High Security Cylinder. 8303DPS • 2" Disc Break Lock 8304DPS • 3" Disc Break Lock</p>  <p>Master Lock.</p>

Trailer / Hitch Locks

Other Padlocks & Etc.

Automatic & Semi-Automatic



040HD AUTOMATIC

040-HD-110VAC

Automatic. The Ilco 040 has dual function to operate in Automatic or Manual mode. Super Jaw 3, "secure grip", four-position vise jaws. Hardened carriage shaft and cutter spindle.



ENGRAVE IT™

ENGRAVE-IT

Automatic. The Engrave-It™ is a stand-alone, counter top engraving unit engineered for the retail environment. Quickly and easily engrave keys, pet tags, ID plates and more.



044HD SEMI-AUTO

044-HD-110VAC

The Premier Speedex® is a manual duplicator, perfect for duplicating even the largest of keys, such as hotel/motel room keys.



BRAVO III SEMI-AUTO

BRAVO-III

Key Machine is a high quality, sturdy key duplicator designed to deliver years of service. The Bravo III has precision "no slip" performance vise jaws, twin shaft carriage transport design, spring loaded carriage, and a micrometer adjustable cutter guide. Delivers unsurpassed accuracy and cutting.



SEMI-AUTOMATIC

KD50C

Automatic power on-off controlled by micro-switch, which is activated by raising or lowering carriage. Makes precise adjustments; 2 micrometer knobs adjust depth and spacing. Lever operated w/ extra wide vise jaws, that securely clamp padlocks, double-sided automotive keys, and large headed keys.



SEMI-AUTO POWER SPEEDEX®

9180MC

The Premier Speedex® is a manual duplicator, perfect for duplicating even the largest of keys, such as hotel/motel room keys.

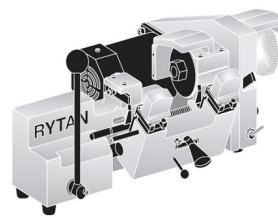

SEMI-AUTOMATIC

RY100

High speed "stick-shift" key cutting action works faster, smoother and more accurately than any other machine you can buy. Quick change top vise jaws. Vises flip over for extra deep cuts only. One cutter cuts all cylinder key. Built-In full function key gauging.

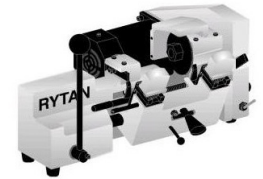

SEMI-AUTOMATIC

RY200

High speed "stick-shift" key cutting action works faster, smoother and more accurately than any other machine you can buy. Quick change 4-way jaws with one cutter that cuts all cylinder keys.



045HD MANUAL

045HD-110VAC

Super Jaw 3, "secure grip", four-position vise jaws. Permanently lubricated cutter spindle shaft ball bearings. Hardened carriage shaft and cutter spindle. Wide spacing between vise jaws. Dial type depth adjustment.



046HD MANUAL

046HD-110VAC

Flat steel & Safe Deposit Key Duplicator. Super Jaw 3, "secure grip", four-position vise jaws. Permanently lubricated cutter spindle shaft ball bearings. Hardened carriage shaft and cutter spindle. Wide spacing between vise jaws.



MINI-MITE

800A-110VAC

Lightweight, compact machine perfect for carrying right to the job. Weighs only 9lbs. Duplicates cylinder keys, large bow keys, and double-sided keys. Two-way reversible vise jaws.

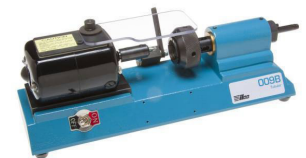

TUBULAR

009B-110VAC

Key cutting machine for tubular keys with frontal cuts. Built in indexing system simplifies duplication of industry standard seven cut keys. Also available without index for cutting offset and eight cut keys. Compact size allows for easy transportation.

Manual



**ECONO TUBULAR
DUPLICUT™**

747E

Duplicates 7-pin standard size tubular keys with spaces in any position and cuts of any depth. Provides an economical key cutting solution for standard size tubular keys.



**MANUAL MINI
SPEEDEX®**

9120RM

9120RMDC-12VDC

One of the most accurate small key machines on the market. Has 4-way jaws, allowing it to cut a wide variety of keys. This lightweight duplicator is able to cut regular or large-bow keys. It also comes equipped with the HPC Softie™ de-burring brush.

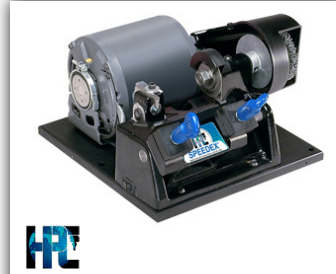

**MANUAL PREMIER
SPEEDEX®**

9160MC

9160MCDC-12VDC

The Premier Speedex® is a manual duplicator, perfect for duplicating even the largest of keys, such as hotel/motel room keys.



POCKET CUT-UP™

TKM-90

The Pocket Cut-Up™ (TKM-90) is a compact, portable tubular key machine. It is factory preset to cut standard size center sequence tubular keys by code.



PRO-LOK

SCHLAGE BLUE PUNCH

BP201SC

Dedicated punch machine designed to cut "factory original" keys by code. Automatic spacing and depth. Classic Sections, Everest and Primus.



PRO-LOK

KWIKSET BLUE PUNCH

BP201KW

Dedicated punch machine designed to cut Kwikset Keys.



PRO-LOK

**BEST/FALCON I/C BLUE
PUNCH**

BP201IC

A2 Standard Interchangeable Core. Best, Falcon & Arrow small format I/C key sections A-R, TA-TE, W. Arrow 1A-4D.



ORIGINAL BLITZ™

1200CMB

Supplied with a deck of 150 code cards & 2 cutters. Choose your FREE GIFT when you register your Original Blitz™, your choice of CodeSource® Lite, a calibration kit or a Medeco® Cutter.



CODE MAX®

1200MAX

High-performance, long-life motor on CodeMax® provides ample torque for cutting a high volume of keys. Equipped with a shoulder gauge safety switch.



SWITCH BLITZ™

1233CMSB

Original Blitz™ code machine combined with a heavy-duty semi-automatic duplicator. Now in the bench space of 1 machine you have 2 top-quality key machines. Comes with 150 code cards and 3 cutters.



TIGER SHARK™

123TSHARK

Touch screen control with 4-way jaws. Extensive code database for commercial, residential, automotive and much more.

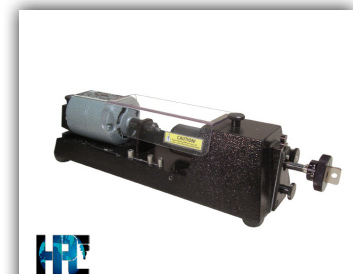

**SCOTSMAN TUBULAR
DUPLICODE™**

747XU

Cuts most of the popular sizes of tubular keys including 7-pin standard, oversized and small bore. Equipped with durable carbide cutter for smooth cutting and a plexiglas shield over the cutter for added safety.

Code Machines



MINI GROOVE™

8000MGDC

The HPC Mini Groove™ is a high-security automotive key duplicator designed for the locksmith on the go. Accurately duplicate virtually all 2-track and 4-track, internal and external keys.



HIGH SECURITY KEY DUPLICATOR

057-HS

Designed specifically for duplicating internal and external track, "laser", "sidewinder" style high security automotive keys (includes 2-track and 4-track versions). Smooth 3-axis movement enhances ease-of-use and accuracy.



DELTA FO TIBBE

DELTA-FO

Specially designed vise jaws securely grip the 6 & 8-space Tibbe keys. Simple spacing mechanism assures quick operation. Dial type depth adjustment simplifies depth calibration process. Direct drive cutter system eliminates v-belt and pulley maintenance. Sealed ball bearing type drive motor



EZ CODE

EZ-CODE

The Ilco EZ-Code is an electronic code machine designed to deliver high level performance at a moderate price. Accurate and simple to operate, the Ilco EZ-Code will cut automotive and commercial keys by biting number, indirect code (automotive keys) or by duplication.



MATRIX HIGH SECURITY

MATRIX-S

Precision control in all three axis provides the ability to duplicate laser and dimple style keys with ease. The MATRIX S vise jaws handle a wide variety of keys without the need for adapters. Features parallel jaws with an interchangeable plate set and movement on three axis.



MATRIX SX HIGH SECURITY

MATRIX-SX

In addition to features found on the MATRIX S, the SX also includes tilting vise fixtures that permit easy duplication of angled surface commercial high security keys and a spring loaded tracing guide that permits easier alignment for duplication.



TRIAX E CODE

TRIAX-ECODE

The Triax-ecode is a three axis stand-alone machine that duplicates and cuts by code the sidewinder / laser style automotive and commercial dimple style keys. Features include a quick and easy cutter change process, automatic calibration, and a dual speed motor.



TRI-CODE HIGH SECURITY

TRI-CODE

High speed "stick-shift" key cutting action works faster, smoother and more accurately than any other machine you can buy. Quick change 4-way jaws with one cutter that cuts all cylinder keys.

Clone & Transponder Machines



CLONE MACHINE

B884

Decryptor Ultegra with Philips. Completely stand alone unit; no computer needed. Identifies & clones TI fixed & encrypted code keys. Identifies & clones Philips Crypto 2nd generation keys. Displays chip type, value and manufacturer.



RW4 PLUS

RW4-PLUS

Duplicates TI fixed & encrypted TI transponders & Philips Encrypted. Duplicates fixed code transponders (T2, T5). Identifies transponder keys. Indicates chip type, value and manufacturer. Comes with SNOOP tool for Philips (car must be present).



TPH CLONER

TPH-CLONER

Philips cloning. Now Clone 95% of the vehicles on the road! Add to TRS-5000 clone machine.



TKO

TKO

The TKO is a second-generation programming tool that features new integrated hardware, enhanced operating software and simple cable connections. The contemporary design is compact and easy to operate.



TKO SELECT

TKO SELECT

Same great tool as the TKO. Only one cable, no dongles or adaptors. Self intuitive, step-by-step procedures on the unit itself. No manual needed for daily operation. No Tokens or paying for software that is never used. You add software as you need.



TCODE

TCODE

Buy Software Programs to fit what you need!



MVP PRO

MVP-PRO

Comes with 35 Tokens. PAY-AS-YOU-GO Transponder Key Programming.



TOKENS FOR MVP PRO

- MVP-TK010**
- MVP-TK025**
- MVP-TK050**
- MVP-TK250**
- MVP-TK-UTP**
- 1 Year Unlimited Token Plan

1200 STANDARD CUTTER
CW-1011
 • 90° angle
 • 0.044" Flat (1.117mm)
 • Small cylinder cutter

HPC SOFTIE™ BRUSH
TYX-3

1200CM MEDECO CUTTER
CW-1012
 • 88° angle
 • 0.015" Flat (0.38mm)

1200 STANDARD CUTTER
CW-14MC
 • 100° angle
 • 0.046" Flat (1.168mm)
 • Large cylinder cutter

CONVERSION KIT
CW-16-KIT
 • Converts 9160MC and 9180MC key machines from standard to flat steel duplicators.

1200CM CUTTER
CW-47MC
 • 87° angle
 • 0.035" Flat (0.889mm)
 • Tool steel cutter for some automotive

CONVERSION KIT
CW-51MC
 • Replaces the following single angle cutters: 23RF, 23RM, 26, CU-5, CU-1, 23MC, 34MC.

1200PCH PUNCH CUTTER
PCH-14

MILL CUTTER
11-MC

MILL CUTTER
19-MC
 Used on-
 • Ilco 2183DM, 2183HM, 010-006
 • Keil 1, 1-1/2, 10

POPULAR ROTARY FILE
23RF

MILL CUTTER
43MC

SLOTTER CUTTER WHEEL
45SMS

MILL CUTTER
9MC
 Used on-
 • Ilco 016, 017, 018

SMALL CUTTER
CW1011MC
 • 90° angle
 • 0.044" Flat (1.117mm)
 • Small cylinder cutter

MEDECO CUTTER
CW1012MC
 • 88° angle
 • 0.015" Flat (0.38mm)

KWIKSET CUTTER
CW1014MC
 • 1200CM cutter

CUTTER FOR LARGE KEYS
CW14MC
 • 100° angle
 • 0.046" Flat (1.168mm)
 • Large cylinder cutter

ILCO CUTTER
CU20
 Used on-
 • 024A, 044, 040

ILCO BRUSH SOFT TOUCH
814-00-51
 • 3" Nylon Brush
 • 1-1/2" Diameter Hole
815-00-51
 • 6" Nylon Brush
 • 1-1/2" Diameter Hole

FIRE RATED COMBO OR ELECTRIC 1411/2

- Gray, Dial Combo or Electric Lock
- Outside: 21-1/4" x 16-1/4" x 18-3/4"
- Inside: 14" x 11" x 10-1/4"
- Weight: 250 lbs.



FIRE RATED COMBO OR ELECTRIC 1612/2

- Gray, Dial Combo or Electric Lock
- Outside: 23-1/4" x 17-1/4" x 19-3/4"
- Inside: 16" x 12" x 11-3/4"
- Weight: 298 lbs.



FIRE RATED COMBO OR ELECTRIC 1812/2

- Gray, Dial Combo or Electric Lock
- Tan, Electric Lock
- Outside: 25" x 17-1/4" x 19-3/4"
- Inside: 18" x 12" x 11-3/4"
- Weight: 313 lbs.



FIRE RATED COMBO OR ELECTRIC 1818/2

- Gray, Dial Combo or Electric Lock
- Outside: 25" x 17-1/4" x 25-3/4"
- Inside: 18" x 12" x 17-3/4"
- Weight: 392 lbs.



FIRE RATED COMBO 3018/2

- Gray, Dial Combo
- Outside: 37-1/4" x 23-1/4" x 25-3/4"
- Inside: 30" x 18" x 17-3/4"
- Weight: 620 lbs.



FLOOR SAFE COMBO B-1307

- Gray, Dial Combo
- Outside: 14-3/4" x 12-7/8" x 11-1/4"
- Inside: 13-3/4" x 12-1/2" x 8"
- Weight: 100 lbs.



FLOOR SAFE COMBO B-1311

- Gray, Dial Combo
- Outside: 14-3/4" x 12-7/8" x 16-1/4"
- Inside: 13-3/4" x 12-1/2" x 13"
- Weight: 117 lbs.



FLOOR SAFE COMBO G-3600

- Gray, Dial Combo
- Outside: 23-1/2" x 12-1/2" x 17-1/4"
- Inside: 22-3/4" x 12" x 13-1/2"
- Door Size: 12" x 12" x 0.5"
- Weight: 169 lbs.



FLOOR SAFE COMBO G-500

- Gray, Dial Combo
- Outside: 8" x 8" x 11-1/2"
- Inside: 7-5/8" x 7-5/8" x 9"
- Door Size: 7-1/2" x 7-1/2" x 1/2"
- Weight: 36 lbs.



FLOOR SAFE COMBO G-700

- Gray, Dial Combo
- Outside: 8" x 8" x 15-1/4"
- Inside: 7-5/8" x 7-5/8" x 13"
- Door Size: 7-1/2" x 7-1/2" x 1/2"
- Weight: 42 lbs.



"B" RATED COMBO OR ELECTRIC B-1515

- Gray, Dial Combo or Electric Lock
- Outside: 15" x 15-3/4" x 12-1/4"
- Inside: 14-1/2" x 15-1/4" x 10-1/2"
- Weight: 130 lbs.



DEPOSIT SAFE COMBO OR KEY DS-86

- Gray, Dial Combo or Key
- Outside: 8" x 6" x 12"
- Inside: 7-1/2" x 5-1/2" x 11"
- Weight: 34 lbs

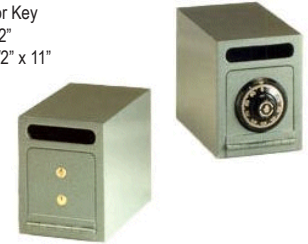

DEPOSIT SAFE COMBO DS-1210

- Gray, Dial Combo
- 2 Hour Fire Rated
- Outside: 12" x 8" x 10"
- Inside: 10-1/4" x 7-1/5" x 9"
- Weight: 47 lbs



DATA-MEDIA SAFE ELECTRIC EDS-1210

- Gray, Dial Combo
- 2 Hour Fire Rated
- Outside: 21 1/2" x 19 1/2" x 18 1/2"
- Inside: 11" x 7" x 7 3/4"
- Weight: 244 lbs



FB SERIES COMBO OR ELECTRIC FB1212

- Gray, Dial Combo or Electric
- 2 Hour Fire Rated
- Outside: 17-3/4" x 17-3/4" x 20-1/2"
- Inside: 12" x 12" x 12-3/4"
- Weight: 206 lbs.



FB SERIES COMBO OR ELECTRIC FB2013

- Gray, Dial Combo or Electric
- 2 Hour Fire Rated
- Outside: 27" x 20" x 20-1/2"
- Inside: 20-1/2" x 13-3/4" x 12-5/8"
- Weight: 312 lbs.



FB SERIES COMBO OR ELECTRIC FB2714

- Gray, Dial Combo or Electric
- 2 Hour Fire Rated
- Outside: 33-1/2" x 20" x 22-3/4"
- Inside: 27-1/2" x 14-1/8" x 15-1/4"
- Weight: 412 lbs.



DOUBLE DOOR DEPOSIT COMBO FL1337

- Gray, Dial Combo
- Outside: 36-1/2" x 14-1/2" x 13"
- Top Inside: 12" x 13-1/2" x 10-3/4"
- Bottom Inside: 12-3/4" x 13-1/2" x 10-3/4"
- Weight: 215 lbs.



<p>FIRE/BURGLARY RATED COMBO GBF1713</p> <ul style="list-style-type: none"> • Gray or Tan, Dial Combo • 1 Hour Fire Rated • Outside: 21-1/4" x 18-1/4" x 20-1/8" • Inside: 16-1/2" x 13" x 13-1/4" • Weight: 355 lbs.  	<p>FIRE/BURGLARY RATED COMBO GBF2016</p> <ul style="list-style-type: none"> • Gray or Tan, Dial Combo • 1 Hour Fire Rated • Outside: 25-1/4" x 21-3/4" x 22-1/8" • Inside: 20" x 16-1/2" x 15-1/4" • Weight: 470 lbs.  	<p>FIRE/BURGLARY RATED COMBO GBF3318</p> <ul style="list-style-type: none"> • Gray, Dial Combo • 1 Hour Fire Rated • Outside: 38-1/4" x 23" x 26-1/4" • Inside: 33" x 17-1/4" x 18" • Weight: 796 lbs.  
<p>GUN SAFE COMBO OR ELECTRIC GF5517</p> <ul style="list-style-type: none"> • Black, Dial Combo or Electronic Lock • 11 Gun Capacity • Outside: 55-1/4" x 22" x 17-3/4" x 16" • Inside: 53" x 16" x 11-1/2" • Weight: 300 lbs.  	<p>GUN SAFE COMBO OR ELECTRIC GF6024</p> <ul style="list-style-type: none"> • Black, Dial Combo or Electronic Lock • 16 Gun Capacity • Outside: 59" x 24" x 22" • Inside: 55" x 21" x 12-1/2" • Weight: 590 lbs.  	<p>GUN SAFE COMBO GF6030</p> <ul style="list-style-type: none"> • Black, Dial Combo • 28 Gun Capacity • Outside: 59" x 30" x 26" • Inside: 55" x 26-3/4" x 20" • Weight: 675 lbs.  
<p>PISTOL SAFE COMBO OR ELECTRIC GS2522</p> <ul style="list-style-type: none"> • Gray, Dial Combo or Electronic Lock • Outside: 25" x 22" x 16-3/4" • Inside: 24-1/2" x 21-1/2" x 13" • Weight: 182 lbs.  	<p>PISTOL SAFE ELECTRIC PS915</p> <ul style="list-style-type: none"> • Black, Electronic Lock • Outside: 4-1/4" x 9-1/2" x 14" • Inside: 3" x 8" x 9" • Weight: 15 lbs.  	<p>CASH REGISTER TRAY SAFE GWB-3522</p> <ul style="list-style-type: none"> • Gray, Dial Combo • Outside: 35" x 21-3/4" x 16-1/2" • Inside: 15-1/2" x 21-1/2" x 14" • Interior Locker: 8-3/4" x 21-1/4" x 10-3/4" • Deposit Door: 13-1/2" x 3" • Weight: 307 lbs.  
<p>HOMEOWNER SAFE ELECTRONIC GH5</p> <ul style="list-style-type: none"> • Gray, Electronic Lock • Outside: 9-1/2" x 16-1/2" x 15" • Door: 7-1/4" x 14-3/4" • Weight: 32 lbs.  	<p>CLOSET SAFE COMBO H2</p> <ul style="list-style-type: none"> • Gray, Dial Combo • Outside: 10-1/4" x 11-1/2" x 12-3/4" • Inside: 9-3/4" x 10-3/4" x 9" • Weight: 70 lbs.  	<p>COMMERCIAL SAFE COMBO LC-1414</p> <ul style="list-style-type: none"> • Gray, Dial Combo • Outside: 14" x 14" x 14" • Inside: 13-1/2" x 13-1/2" x 11" • Weight: 61 lbs.  
<p>DEPOSIT SAFE COMBO LCF-2014</p> <ul style="list-style-type: none"> • Gray, Dial Combo • Outside: 20" x 14" x 14" • Front Loading Capacity: 10-1/2" x 11" • Weight: 80 lbs.  	<p>CASH MANAGEMENT SAFE COMBO LCF-2820</p> <ul style="list-style-type: none"> • Gray, Dial Combo • Outside: 28" x 20" x 16" • Top: 8" x 16" x 13" • Bottom: 8-1/2" x 16" x 13" • Weight: 174 lbs.  	<p>CASH MANAGEMENT SAFE COMBO LCF-3020</p> <ul style="list-style-type: none"> • Gray, Dial Combo • Outside: 30" x 20" x 20" • Front Loading Capacity: 20" x 17" • Weight: 201 lbs.  
<p>CASH MANAGEMENT SAFE COMBO LCF-3214</p> <ul style="list-style-type: none"> • Gray, Dial Combo • Outside: 32" x 14" x 14" • Top: 11" x 13" x 11" • Bottom: 12" x 13" x 11" • Weight: 174 lbs.  	<p>ROTARY DROP SAFE COMBO LCR-2014</p> <ul style="list-style-type: none"> • Gray, Dial Combo • Outside: 20" x 14" x 14" • Inside: 11" x 13" x 11" • Weight: 87 lbs.  	<p>DEPOSIT SAFE COMBO LCS-1414</p> <ul style="list-style-type: none"> • Gray, Dial Combo • Outside: 14" x 14" x 14" • Door: 10-1/2" x 10-3/4" • Weight: 61 lbs.  

Gardall Safes

HOME/OFFICE SAFE

MS119

- Gray, Dial Combo or Electric Lock
- Outside: 15-1/2" x 11-3/4" x 12-1/2"
- Inside: 12-1/4" x 8-3/4" x 8-1/2"
- Weight: 61 lbs.



HOME/OFFICE SAFE

MS129

- Gray, Dial Combo or Electric Lock
- Outside: 16-3/4" x 13-1/2" x 15-1/4"
- Inside: 12-3/4" x 9-1/2" x 10-1/4"
- Weight: 85 lbs.



HOME/OFFICE SAFE

MS911

- Gray, Dial Combo or Electric Lock
- Outside: 11-1/2" x 15-1/4" x 12-1/2"
- Inside: 8-1/2" x 12" x 8-1/2"
- Weight: 61 lbs.



HOME/OFFICE SAFE

MS912

- Gray, Dial Combo or Electric Lock
- Outside: 13-1/2" x 16-3/4" x 15-1/4"
- Inside: 9-1/2" x 12-3/4" x 10-1/4"
- Weight: 85 lbs.



2 HOUR FIRE SAFE

SS1612

- Gray, Dial Combo
- Outside: 20" x 16-1/4" x 17-1/2"
- Inside: 14-1/2" x 12" x 14-1/4"
- Weight: 140 lbs.



2 HOUR FIRE SAFE

SS4422

- Gray, Dial Combo
- Outside: 50-3/4" x 29-1/4" x 25-1/4"
- Inside: 39-1/2" x 22-1/2" x 17-1/2"
- Weight: 805 lbs.



WALL SAFE

SL4000/F

- Gray, Dial Combo
- Outside: 12-1/4" x 14-1/4" x 4"
- Inside: 12" x 13-1/2" x 2-3/4"
- Weight: 39 lbs.



INSULATED WALL SAFE

WMS912

- Gray, Electric Lock
- Outside: 13-1/2" x 16-3/4" x 15-1/4"
- Inside: 9-1/2" x 12-3/4" x 10-1/4"
- Weight: 101 lbs.



FIRE CHEST

GLSF-FC15

- Textured Finish, Electric Lock
- Holds 8-1/2" x 11" size documents
- Offers 30 minutes of fire resistance



FIRE SAFE

GLSF-FR31

- Epoxy Powder Coated Finish, Electric Lock
- 3 - 8 digit code with key override
- Offers 30 minutes of fire resistance



SINGLE NOSE SAFE/CABINET LOCK

4113-03

- This lock is essentially the renter half of a 4500 series safe deposit lock.
- Ideal for cabinets and interior safe compartments.



DOUBLE NOSE FIXED LEVER LOCK

4440-018-PREP4

- Left or Right Hand



BIG NOSE LITTLE NOSE LOCK

4442-014-PREP4

- Right Hand
- Made for matchwork to Diebold 175 series locks to expand existing safe deposit installations.

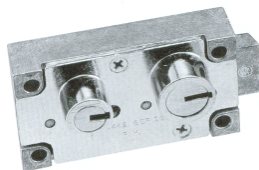

DOUBLE BIG NOSE LOCK

4443-008-PREP4

- Left or Right Hand
- Designed for matchwork to Mosler 5700 series systems to expand existing safe deposit installations.



DOUBLE NOSE EXTENDED BOLT

4444-002-PREP4

- Right Hand

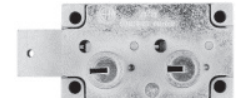

SPY PROOF DIAL

Goes with Dial Ring SG-R167-002.

D220-014

- Regular Knob
- R167-002
- Large Knob



Z02 DRIVE SAFE LOCK

2004-200

- Manual bolt operation—bolt retraction by turning the outer ring of the keypad after a valid code is entered.
- The Z02 D-Drive lock incorporates a penalty time feature to prevent opening by sequential or random codes until a valid code is found.



ELECTRIC SAFE LOCK

6120-305

- One million codes to choose from.
- One master code and eight user codes.
- Capable of a management reset code.
- Programmable time delay of one to nine minutes can easily be activated from the keypad.



Pro Lock Safes

Sargent & Greenleaf

**DON'T SEE WHAT YOU NEED
GIVE US A CALL AND WE CAN HELP YOU!**



415-970-5000 or 800-FOR-LOCK

**Don't forget to check out our website
for price & availability**

www.plsgroup.com/R&H

VISA



DISCOVER

Order Online @ plsgroup.com/R&H