



**MARKSUSA**

---

---

# **2017 / 2018**

## **Price List**

---

---

**Mortise Locksets**

**Cylindrical, Tubular & Electronic  
Access Control Locksets**

**Exit Devices**



September 2017

# MORTISE LOCKSET PRICE LIST • EFFECTIVE SEPTEMBER 2016

## TABLE OF CONTENTS

|   |              |
|---|--------------|
| <b>Required Information</b> .....                           | <b>6</b>     |
| Backset .....   | 6            |
| Door Thickness .....  | 6            |
| Handing .....   | 6            |
| <b>Mounts &amp; Displays</b> .....                          | <b>6</b>     |
| <b>Mortise Lock Trim Information</b> .....                  | <b>7</b>     |
| Handleset Trim .....  | 7            |
| Lever/Knobset Trim .....                                    | 7            |
| <b>How To Order Mortise Locksets &amp; Handlesets</b> ..... | <b>8-10</b>  |
| How To Order Instructions & Examples .....                  | 8            |
| 1. Series .....   | 9            |
| 2. Plates/Roses/Handlesets .....                            | 9            |
| 3. Knob/Lever .....   | 9            |
| 4. Mortise Functions .....                                  | 9            |
| 5. Finishes .....   | 9            |
| 6. Options .....  | 10           |
| <b>Plate Designs</b> .....                                  | <b>11-27</b> |
| Barrier - BA .....  | 11           |
| Classic - CL .....  | 12-13        |
| Capitol - CP .....  | 14-15        |
| Crown - CR .....  | 16-17        |
| Drake - DR .....  | 18-19        |
| Davos - DV .....  | 20-21        |
| Madison - MA .....  | 22-23        |
| New Yorker - NY .....                                       | 24-25        |
| Towne - TN .....  | 26-27        |
| <b>Rose Designs</b> .....                                   | <b>28-29</b> |
| Rose with Ring - RR .....                                   | 28-29        |
| Plain Rose - RW .....                                       | 28-29        |
| Small Rose with Ring - RQ .....                             | 28-29        |
| Small Rose - RS .....                                       | 28-29        |
| Square Rose - RX .....                                      | 28-29        |
| Square Rose - RK .....                                      | 28-29        |
| Square Rose - RL .....                                      | 28-29        |
| <b>Handleset Designs</b> .....                              | <b>30-31</b> |
| Crown - CR .....  | 30           |
| Towne - TN .....  | 32           |
| <b>Ornamental Iron</b> .....                                | <b>32-33</b> |
| Series 21 Unilock™ .....                                    | 32           |
| Series 22 .....   | 32           |
| Series 9215 Unilock™ .....                                  | 32           |
| Series 9225 .....   | 32           |
| Series 9257 Unilock™ .....                                  | 32           |
| Series 9267 .....   | 32           |
| THINLINE® Series 2750 .....                                 | 32           |
| Knob & Lever Kits .....                                     | 33           |
| Accessories .....   | 33           |
| Cylinders .....   | 33           |

# MORTISE LOCKSET PRICE LIST

|   |              |
|---|--------------|
| <b>Mortise Parts &amp; Trim</b> .....   | <b>34-46</b> |
| Mortise Lock Bodies Series 4 & 45 .....   | 34           |
| Mortise Lock Bodies Series 5 & 55 .....   | 35           |
| Mortise Lock Bodies Series 6 & 8 .....  | 36           |
| Mortise Lock Bodies Series 7 & 9 .....  | 37           |
| Mortise Deadlocks Series 31, 2, 3, 5 & 55 .....                                   | 38           |
| Mortise Lockset Functions .....   | 39-40        |
| Mortise Lock Parts: Knob/Lever Rose Kits .....                                    | 41           |
| Mortise Lock Parts: Dummy Cylinder, Collars & Turnpieces, Strikes, Spindles ..... | 42           |
| Trim Lock Parts: How to Order .....   | 43           |
| Trim Lock Parts: Plate/Rose Design .....  | 44           |
| Trim Lock Parts: Knob/Lever Design .....  | 45           |
| Trim Lock Parts: Handle Design .....  | 46           |
| Mortise Door Accessories .....  | 46           |

# CYLINDRICAL & TUBULAR LOCKSET PRICE LIST

|   |              |
|---|--------------|
| <b>How To Order Cylindrical Locksets</b> .....                                      | <b>47</b>    |
| How To Order Example For Cylindrical Locksets .....                                 | 47           |
| 1. Series .....   | 47           |
| 2. Cylindrical Functions .....  | 47           |
| 3. Finishes .....   | 47           |
| 4. Options .....  | 47           |
| <b>Cylindrical Locksets</b> .....   | <b>48-51</b> |
| 80 Line Grade 1 Cylindrical Knobsets .....  | 48           |
| 10 Line Grade 2 Cylindrical Knobsets .....  | 49           |
| 95 Line Grade 1 Cylindrical Survivor Series Leversets .....                         | 50           |
| 75 Line Grade 2 Cylindrical Survivor Series Leversets .....                         | 51           |
| <b>Residential Interior Cylindrical Locksets</b> .....                              | <b>52</b>    |
| 1120 Series Grade 2 Knobsets ( <i>cylindrical knobsets for interior use</i> ) ..... | 52           |
| 230 Series Knobsets ( <i>cylindrical knobsets for interior use</i> ) .....          | 52           |
| <b>Cylindrical Lock Accessories</b> .....   | <b>53</b>    |
| Latches, Strikes, Spacer Rings, Etc. ....   | 53           |
| Marks Survivor Series Lock Installation Tool J295 .....                             | 53           |
| Cylinders, Cylindrical Lock Tailpieces, Cylindrical IC Core Tailpieces .....        | 53           |
| How to order example for Cylindrical Lock Cylinders & Tailpieces .....              | 53           |
| <b>Cylindrical Knob/Lever Functions</b> .....                                       | <b>54</b>    |
| <b>How To Order Tubular Locksets</b> .....  | <b>55</b>    |
| How To Order Example For Tubular Locksets .....                                     | 55           |
| 1. Series .....   | 55           |
| 2. Roses .....  | 55           |
| 3. Knob/Lever .....   | 55           |
| 4. Tubular Function .....   | 55           |
| 5. Finishes .....   | 55           |
| 6. Options .....  | 55           |
| Tubular Knob & Lever Functions .....  | 55           |
| <b>Rose Designs</b> .....   | <b>56</b>    |
| Rose with Ring - RR .....   | 56           |
| Plain Rose - RW .....   | 56           |
| Small Rose with Ring - RQ .....   | 56           |
| Small Rose - RS .....   | 56           |
| Square Rose - RX .....  | 56           |
| Square Rose - RK .....  | 56           |
| Square Rose - RL .....  | 56           |
| <b>Residential Interior Tubular Locksets</b> .....                                  | <b>57</b>    |
| 150 Series American Lever ( <i>tubular leversets for interior use</i> ) .....       | 57           |
| 250 Series Crescent Lever ( <i>tubular leversets for interior use</i> ) .....       | 57           |
| 450 Series Titan Lever ( <i>tubular leversets for interior use</i> ) .....          | 57           |
| <b>Tubular Lockset Accessories</b> .....  | <b>58</b>    |
| Strikes, Latches, Support Housing .....   | 58           |
| Turnpieces .....  | 58           |
| Latches & Cylindrical Cartridge .....   | 58           |
| <b>How To Order For Defender Locksets</b> .....                                     | <b>59</b>    |
| How To Order Example For Defender Locksets .....                                    | 59           |
| 1. Series .....   | 59           |
| 2. Tubular Functions .....  | 59           |
| 3. Finishes .....   | 59           |
| 4. Options .....  | 59           |
| <b>Deadbolt/Deadlatch Functions</b> .....   | <b>59</b>    |

# CYLINDRICAL & TUBULAR LOCKSET PRICE LIST

|   |              |
|---|--------------|
| <b>Defender Series Tubular Deadbolts &amp; Cylindrical Cartridge Deadlatches</b> .....  | <b>60</b>    |
| 130 Series Grade 1 Defender Tubular Deadbolts .....                                     | 60           |
| 145 Series Grade 1 Defender Cylindrical Cartridge Deadlatches .....                     | 60           |
| <b>Defender Series Accessories</b> .....  | <b>61</b>    |
| Strikes, Latches & Spacers .....  | 61           |
| Latches & Cylindrical Cartridge .....   | 61           |
| Tailpieces & Cylinders .....  | 61           |
| <b>i-Qwik/i-Que Electronic Access Control Locksets</b> .....                            | <b>62-64</b> |
| i-Qwik LITE <sup>2</sup> Series Electronic Access Control & How To Order Example .....  | 62           |
| i-Qwik/i-Que Series Options .....   | 63           |
| i-Qwik/i-Que Series Accessories, Tailpieces & Cams .....                                | 64           |
| <b>Request To EXit (REX) Leversets &amp; Electrified Locksets</b> .....                 | <b>65-66</b> |
| Request To EXit (REX) Cylindrical Grade 1 Leversets (EA195, EA295, EA395 & EA495) ..... | 65           |
| How To Order Example For REX Leversets .....  | 65           |
| 195, 295, 395 & 495 Series Grade 1 Electrified Cylindrical Leversets .....              | 66           |
| 5 Series Grade 1 Electrified Mortise Lockset .....                                      | 66           |
| <b>Gate Locks</b> .....   | <b>67</b>    |
| Swinging Gate Locks .....   | 67           |
| Sliding Gate Locks .....  | 67           |
| Parts .....   | 67           |
| <b>Custom Lockset Division</b> .....  | <b>68-70</b> |
| Series HA113 Housing Authority Mortise Lockset .....                                    | 68           |
| Series LA318GJ Maximum Security Mortise Lockset .....                                   | 69           |
| Series BE101 & LA3118 .....   | 70           |
| <b>Institutional Life Safety Mortise Locksets</b> .....                                 | <b>71-73</b> |
| Series 195SS Institutional Life Safety Cylindrical Lever Lockset .....                  | 71           |
| Series 5SS55 & 5SS19 Institutional Life Safety Mortise Knob & Lever Locksets .....      | 72           |
| Series 180SS Institutional Life Safety Cylindrical Knobsets & Locksets .....            | 73           |
| Series 31SS55 Institutional Life Safety Mortise Deadlock .....                          | 73           |
| <b>Hospital Locksets</b> .....  | <b>74</b>    |
| Series 180PD Cylindrical Push/Pull Paddlesets .....                                     | 74           |
| Series 5PD & 55PD Mortise Push/Pull Paddlesets .....                                    | 74           |
| <b>Mortise Lock Cylinders, Parts &amp; Cams</b> .....                                   | <b>75</b>    |
| Cylinders, IC Core Cylinder Housings, Cylinder Cams .....                               | 75           |
| How To Order For Mortise Lock Cylinders .....   | 75           |
| <b>KEYS &amp; KEYING</b> .....  | <b>76</b>    |
| <b>HI-SECURITY™ Cylinders</b> .....   | <b>77-82</b> |
| HI-SECURITY™ Cylinders: NON-UL .....  | 77           |
| HI-SECURITY™ Cylinders: UL 437 .....  | 78           |
| Security-Mate™ Cylinders, Special Application Cylinders .....                           | 79           |
| How To Order HI-SECURITY™ Cylinders and Keys .....                                      | 80           |
| Keys, Cams & Tailpieces .....   | 81           |
| Parts List .....  | 82           |

# DOOR CLOSERS & PANIC DEVICES PRICE LIST

|  |              |
|--|--------------|
| <b>Exit Devices</b> .....                                  | <b>83-87</b> |
| Series M9900 Exit Device - Rim Mount .....                 | 83           |
| Series M9900 VR Exit Device - Surface Vertical Rod .....   | 83           |
| Series M9900 Exterior Trim .....                           | 84           |
| Series M9900 Cams & Tailpieces .....                       | 84           |
| Series M8800 Exit Device .....                             | 84           |
| Series M195 .....  | 85           |
| Series M9300 Exit Device - Mortise .....                   | 85           |
| Electric Latch Retraction with Simultaneous Dogging .....  | 86           |
| Exit Alarm .....   | 86           |
| Electric Frame Actuator .....                              | 87           |
| Electric Dogging .....                                     | 87           |
| Delayed Egress .....                                       | 88           |
| M9900 LITE .....   | 88           |
| <b>Power Transfer Hinges &amp; Loops</b> .....             | <b>89</b>    |
| <b>Touchless Exit Switch</b> .....                         | <b>90</b>    |
| <b>How To Order Door Closers &amp; Panic Devices</b> ..... | <b>91</b>    |
| <b>NEW! ArchiTech™ Series Networx Locks</b> .....          | <b>92-93</b> |

**Marks USA Antimicrobial finish**

Peace of mind for your hardware application when protected against GERMS and MOLD using Stericoat AM. Marks USA antimicrobial finish is recommended for hospitals, assisted living facilities, schools and childcare facilities. **Use Code - AM**

**Lifetime Mechanical Limited Warranty:** MARKS USA warrants that its products are free from defects in materials and workmanship. This warranty is limited to the lifetime of the door on which our lock is installed. In the event our product does not conform to this warranty, MARKS USA will repair or replace the product free of charge. This warranty does not cover defects or damage arising from improper installation, lack of or improper maintenance, improper storage, shipping and handling, ordinary wear and tear, misuse, abuse, accident, unauthorized service, or use with unauthorized non-MARKS products or parts. We reserve the right to make changes in materials, components or manufacturing methods. Liability under all warranties expressed or implied is limited to replacement of the defective goods. This warranty does not cover nor provide for the reimbursement or payment of incidental or consequential damages. Additionally, the company will not warrant ANSI A156.2 Grade 2 lever product installed in educational facilities and student housing.

**2 Year Electronic Limited Warranty:** MARKS USA warrants to the original purchaser that its products are free from defects in materials and workmanship so long as they occupy the premises.

In the event our product does not conform to this warranty, MARKS USA will repair or replace the product free of charge at its sole discretion. This warranty does not cover defects or damage arising from improper installation, lack of or improper maintenance, improper storage, shipping and handling, improper application or specification, ordinary wear and tear, misuse, abuse, accident, improper voltage, unauthorized service, or use with unauthorized non-MARKS products or parts. We reserve the right to make changes in materials, components or manufacturing methods. Liability under all warranties expressed or implied is limited to replacement of the defective goods. This warranty does not cover nor provide for the reimbursement or payment of incidental or consequential damages or any shipping charges related to exercising of this warranty.

**Lifetime Finish Limited Warranty:** MARKS USA Locksets with the "3E" finish will be warranted to the original user against tarnishing as long as the user occupies the residential premises upon which the lockset was originally installed. Locksets with this finish, used in commercial applications will be limited to two years. This warranty does not cover scratches, abrasion, abused or misused products. Upon return of a defective product to Marks USA, we will, at our sole discretion, either replace the product or refund the purchase price in exchange for the product.

Due to climatic conditions, chemical or abrasive actions, other finishes are excluded from this warranty. This warranty does not cover nor provide for the reimbursement or payment of incidental or consequential damages arising from the sale of the product.

**Terms & Conditions:**

**TERMS:** Net 30

**FREIGHT:** Prices are F.O.B. Amityville, New York. Freight allowed on shipments over \$7000 net invoice value within Continental U.S.

**RETURNED GOODS:** Goods may not be returned without a Returned Goods Authorization (RGA) and are subject to a restocking charge. RGA label must be on all cartons.

**MINIMUM CHARGE:** Orders for less than \$250 net invoice are subject to a \$25 handling charge.

**MINIMUM SALES VOLUME:** The company reserves the right to discontinue direct sales to any customer who does not meet the minimum annual sales requirements during any 12 month period. Minimum annual sales volume is determined on the basis of accepted orders during each applicable year. All orders are acknowledged. It is the customers responsibility to check accuracy of the acknowledgment when received.

ArchiTech, Networx, iLock, LocDown, LifeSaver and Hi-Security are trademarks of Marks USA, a division of Napco Security Technologies. All other trademarks listed are properties of their respective companies.

Effective Septemeber 2016. All prices published are suggested list prices in US Dollars. Some specifications are preliminary and subject to change without prior notice. Not responsible for typographical errors. Marks USA is a Division of Napco Security Technologies, Inc. (NASDAQ:NSSC) © Marks USA, 9.16

**BACKSET - Required Information**

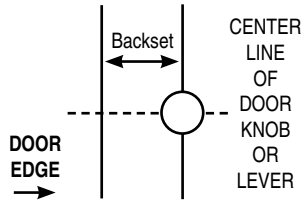

**DOOR THICKNESS - Required Information**

**STANDARD DOOR THICKNESS RANGE:**  
 Mortise locksets: 1-3/4"  
 Cylindrical locksets: 1-5/8" through 1-7/8"  
 Ornamental locksets: 1" through 1-1/4"  
 Tubular locksets: 1-3/8" through 1-3/4"  
 Other door thickness: **Consult factory**

**SPECIFY:**  
 Door thickness (A)  
 Lock location (B)

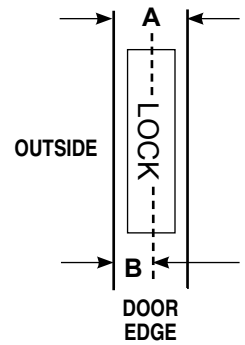

**HANDING - Required Information**

**All locksets supplied 1/2 (LH) and 1/2 (RH) unless otherwise specified**

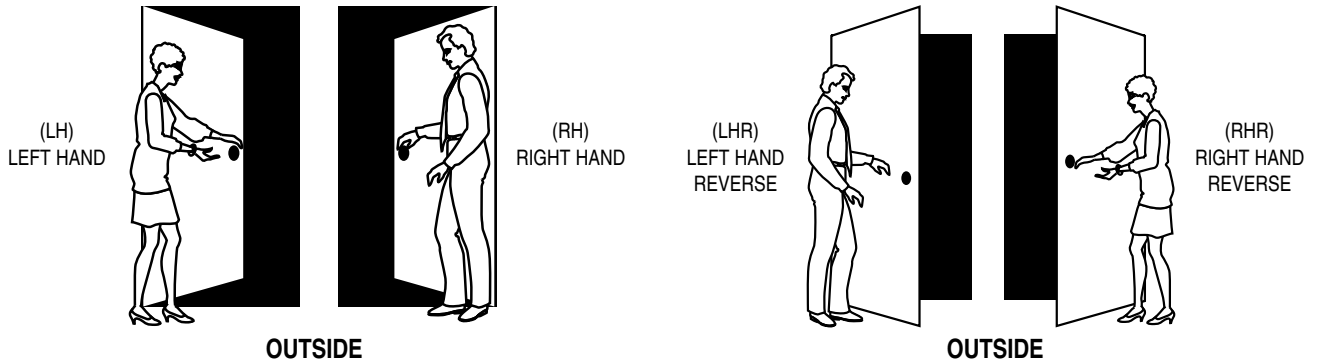

**MOUNTS & DISPLAYS AVAILABLE, CONSULT FACTORY**



# MORTISE LOCK TRIM INFORMATION

## HANDLESET TRIM

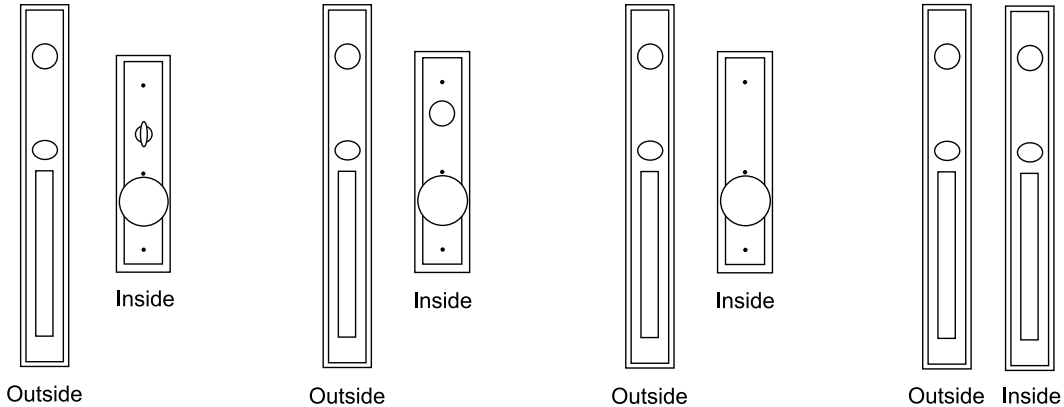

**ENTRANCE**  
Cylinder/Turnpiece

**ENTRANCE**  
Double Cylinder

**DUMMY TRIM**  
Both Sides

**HANDLE SET**  
With Ext. &  
Int. Handle

## LEVERSET/KNOBSET TRIM

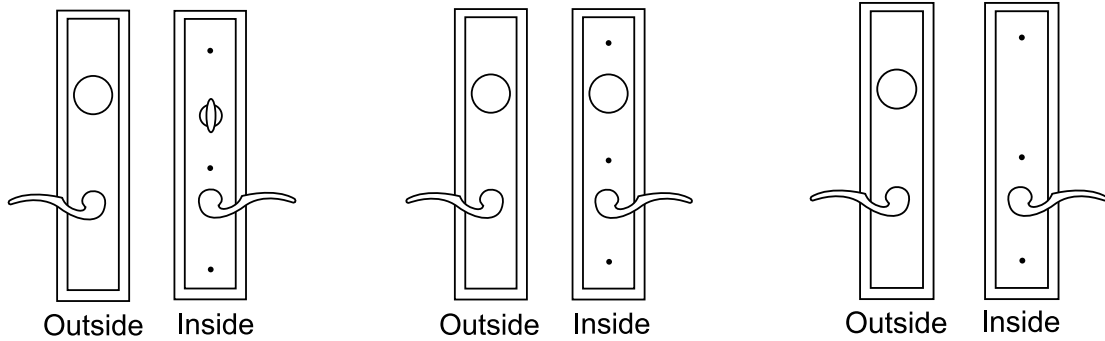

**ENTRANCE**  
Cylinder/Turnpiece

**ENTRANCE**  
Double Cylinder

**OFFICE/CLASSROOM**

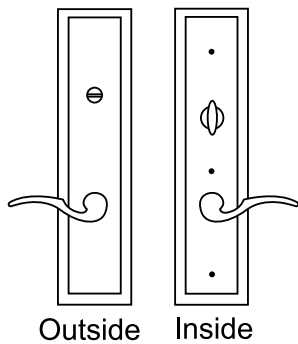

**PRIVACY**

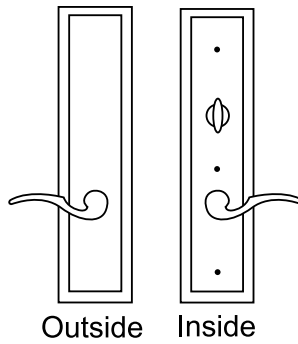

**EXTERIOR/PATIO**

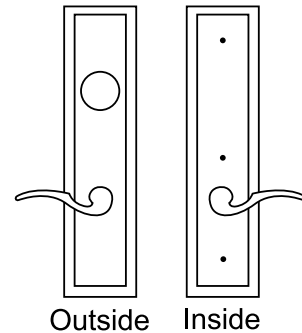

**DUMMY TRIM**  
Both sides

\*Dummy cylinder optional (F17)

# How To Order MORTISE LOCKSETS & HANDLESETS

1. Select type of lockset.
2. See corresponding pages in the catalogues for information regarding this type of lock.
3. Create the part number for your lock by selecting the information from fields 1 through 6.  
Please note dummy trim is Series "0".
4. Options must be listed in Alpha - Numeric order.
5. Note that if Part Number is over 15 characters, it becomes a special number with the option field \*1.  
(Your options will then be listed separately.)  
*Please note the standard (default) features of each lock - they do not need to be selected in the options section.*
6. Please indicate keying detail or special instructions on each item ordered.
7. Door Templates are available on the website @ [www.marksus.com/support/templates](http://www.marksus.com/support/templates)

|  |                   |                         |                         |                      |          |              |          |               |
|--|-------------------|-------------------------|-------------------------|----------------------|----------|--------------|----------|---------------|
| How To Order Example<br>for Mortise Locksets | <b>7</b>          | <b>NY</b>               | <b>10</b>               | <b>A</b>             | <b>/</b> | <b>3</b>     | <b>—</b> | <b>G3</b>     |
|  | 1.<br>Lock Series | 2.<br>Plate/Rose Design | 3.<br>Knob/Lever Design | 4.<br>Marks Function | Slash    | 5.<br>Finish | Dash     | 6.<br>Options |

|   |                   |                         |                         |                      |          |              |          |               |
|---|-------------------|-------------------------|-------------------------|----------------------|----------|--------------|----------|---------------|
| How To Order Example<br>for Rose Design | <b>5</b>          | <b>RW</b>               | <b>92</b>               | <b>N</b>             | <b>/</b> | <b>10B</b>   | <b>—</b> | <b>D1</b>     |
|   | 1.<br>Lock Series | 2.<br>Plate/Rose Design | 3.<br>Knob/Lever Design | 4.<br>Marks Function | Slash    | 5.<br>Finish | Dash     | 6.<br>Options |

|   |              |                        |                                  |                      |          |              |          |               |
|---|--------------|------------------------|----------------------------------|----------------------|----------|--------------|----------|---------------|
| How To Order<br>Example for<br>Handlesets | <b>6</b>     | <b>CB</b>              | <b>60</b>                        | <b>AC</b>            | <b>/</b> | <b>15</b>    | <b>—</b> | <b>G3</b>     |
|   | 1.<br>Series | 2.<br>Handleset Design | 3.<br>Interior Knob/Lever Design | 4.<br>Marks Function | Slash    | 5.<br>Finish | Dash     | 6.<br>Options |

|   |              |                      |          |              |          |               |
|---|--------------|----------------------|----------|--------------|----------|---------------|
| How To Order Example<br>for Ornamental Iron | <b>9215</b>  | <b>AC</b>            | <b>/</b> | <b>15</b>    | <b>—</b> | <b>G3</b>     |
|   | 1.<br>Series | 2.<br>Marks Function | Slash    | 3.<br>Finish | Dash     | 4.<br>Options |

|   |              |                      |          |              |          |               |
|---|--------------|----------------------|----------|--------------|----------|---------------|
| How To Order Example<br>for Mortise Lock Bodies | <b>55</b>    | <b>JM</b>            | <b>/</b> | <b>26D</b>   | <b>—</b> | <b>T</b>      |
|   | 1.<br>Series | 2.<br>Marks Function | Slash    | 3.<br>Finish | Dash     | 4.<br>Options |



# How To ORDER MORTISE LOCKSETS & HANDLESETS

| 1 SERIES                   |                          |
|----------------------------|--------------------------|
| Dummy Trim                 | 0                        |
| Dummy Trim Handlesets Only | 00                       |
| Mortise Locks              | 4, 45, 5, 55, 6, 7, 8, 9 |
| Mortise Deadlocks          | 31, 2, 3                 |

| 2 PLATES/ROSES/HANDLESETS |                                  |        |
|---------------------------|----------------------------------|--------|
| PLATES                    |                                  | DESIGN |
| Barrier                   |                                  | BA     |
| Classic                   |                                  | CL     |
| Capitol                   |                                  | CP     |
| Crown                     |                                  | CR     |
| Drake                     |                                  | DR     |
| Davos                     |                                  | DV     |
| Madison                   |                                  | MA     |
| New Yorker                |                                  | NY     |
| School                    |                                  | LA     |
| Towne                     |                                  | TN     |
| ROSES                     |                                  | DESIGN |
| 9602-R                    | Rose with ring 2-9/16" dia.      | RR     |
| 9602                      | Plain rose 2-9/16" dia.          | RW     |
| 5602-R                    | Small rose with ring 2-1/4" dia. | RQ     |
| 5602                      | Small rose 2-1/4" dia.           | RS     |
| 7602                      | Square rose 2-9/16"              | RX     |
| 7607                      | Square forged rose 2-9/16"       | RK     |
| HANDLESETS                |                                  | DESIGN |
| Crown                     |                                  | CR     |
| Towne                     |                                  | TN     |

| 3 KNOB/LEVER |                 |    |
|--------------|-----------------|----|
| KNOB         | DESIGN          |    |
| 1153         | Round, wrought  | 10 |
| 1253         | Ball, wrought   | 20 |
| 9631         | Ball, forged    | 30 |
| 9609         | Eclipse, forged | 60 |
| LEVERS       | DESIGN          |    |
| 5642         | Stanhope        | 44 |
| 5657         | Brompton        | 55 |
| 5662         | Monaco          | 57 |
| 5672         | Towne           | 72 |
| 5677         | Maxwell         | 77 |
| 5678         | Omni            | 78 |
| 5682         | Plaza           | 82 |
| 5683         | Dayton          | 83 |
| 5686         | Crescent        | 86 |
| 5692         | American        | 92 |
| 5696         | Titan           | 96 |

| 4 MORTISE FUNCTIONS                         |                       |      |
|---|-----------------------|------|
| <b>MARKS FUNCTION:</b>                      |                       |      |
| <b>KEYED SINGLE CYLINDER, NO DEADBOLT</b>   |                       |      |
|   | <b>ANSI #</b>         |      |
| D   | OFFICE/VEST.          |      |
| DW  | VESTIBULE             |      |
| E   | OFFICE                | F04  |
| EW  | STOREROOM             | F07  |
| EX  | EXIT                  | F31  |
| J   | CLASSROOM             | F05  |
| JM  | HOSPITAL              | F06  |
| JR  | HOSPITAL              | F06  |
| GL  | INST PRIVACY          | F26  |
| EN  | STOREROOM             |      |
| DN  | STOREROOM             |      |
| EL  | ELECTRICALLY LOCKED   |      |
| EU  | ELECTRICALLY UNLOCKED |      |
| <b>KEYED SINGLE CYLINDER, WITH DEADBOLT</b> |                       |      |
|   | <b>ANSI #</b>         |      |
| A   | ENTRANCE              | F08, |
| F10   |                       |      |
| B   | ENTRANCE              | F21  |
| F   | DORMITORY             | F12  |
| FS  | DORMITORY             |      |
| FW  | DORMITORY             | F13  |
| FD  | APARTMENT             | F20  |
| H   | HOTEL                 | F15  |
| LH  | SPECIAL PRIVACY       |      |
| <b>KEYED DOUBLE CYLINDER, NO DEADBOLT</b>   |                       |      |
|   | <b>ANSI #</b>         |      |
| G   | ENTRANCE              | F09  |
| GC  | INTRUDER LATCHBOLT    | F32  |
| GG  | CLASSROOM SECURITY    |      |
| GR  | CLASSROOM SECURITY w/ |      |
| HOLDBACK                                    |                       |      |
| WW  | INSTITUTION           | F30  |
| <b>KEYED DOUBLE CYLINDER, WITH DEADBOLT</b> |                       |      |
|   | <b>ANSI #</b>         |      |
| AC  | ENTRANCE              | F35  |
| C   | STOREROOM             | F14  |
| FC  | INTRUDER DEADBOLT     | F34  |
| FA  | DORMITORY             | F11  |
| FX  | DORMITORY             | F33  |
| SO  | STOREROOM             | F25  |
| <b>KEYLESS</b>                              |                       |      |
|   | <b>ANSI #</b>         |      |
| N   | PASSAGE               | F01  |
| L   | BATHROOM              | F02  |
| LF  | PRIVACY               | F19  |
| LJ  | PRIVACY               | F22  |
| <b>DUMMY TRIM</b>                           |                       |      |
|   | <b>ANSI #</b>         |      |
| DI  | DUMMY TRIM INSIDE     |      |
| DO  | DUMMY TRIM OUTSIDE    |      |
| DT  | FULL DUMMY TRIM       |      |



| 5 FINISH  |   |                |
|-----------|---|----------------|
| MARKS     |   | ANSI #         |
| US 3      | Polished Brass, Clear Coated                | 605            |
| US 3E     | Polished Brass "PVD"                        | 605E           |
| US 4      | Satin Brass, Clear Coated                   | 606, 606E      |
| US 5      | Antique Brass, Clear Coated                 | 609, 609E      |
| US 10E    | Satin Bronze "PVD"                          | 612E           |
| US 10     | Satin Bronze, Clear Coated                  | 612            |
| US 10B    | Dark Bronze, Clear Coated                   | 613E           |
| US 14     | Bright Nickel Plating, Clear Coated         | 614            |
| US 15     | Satin Nickel                                | 619, 619E      |
| US 19     | Flat Black, Powder Coated                   | 622, 622E      |
| US 20A    | Dark Oxidized Statuary Bronze, Clear Coated | 624            |
| US 26     | Polished Chrome, Plated                     | 625            |
| US 26D    | Satin Chrome, Plated                        | 626            |
| US 26E    | Satin Chrome, Powder Coat                   | 626E           |
| US 32     | Polished Stainless Steel                    | 629            |
| US 32D    | Satin Stainless Steel                       | 630            |
| <b>AM</b> | <b>Antimicrobial Finish</b>                 | <b>AM, +40</b> |

| FINISH DESIGNATIONS   |  |
|---|--|
| <b>Split Finish Designation</b>   |  |
| Marks USA Antimicrobial finish - Code: AM                                 |  |
| Split Finish: Exterior one finish/interior one finish designate by an "X" |  |
| Ex: 4TN57A/3Ex15-F3   |  |
| Exterior trim 3E Interior Trim US 15                                      |  |
| <b>Combination Finish Designation</b>                                     |  |
| Combination Finish:   |  |
| Alternating different finishes on same side of trim designate by          |  |
| a "/" between finishes  |  |
| Ex: 4TN57A/3E/15-F3   |  |
| Exterior and Interior trim 3E   |  |
| US 15 cylinder, turnpiece & lever.  |  |



# How To ORDER MORTISE LOCKSETS & HANDLESETS

| 6   |      |     | OPTIONS     |              |                                       |     |             |              |  |     |      |             |              |
|---|------|-----|-------------|--------------|---------------------------------------|-----|-------------|--------------|--|-----|------|-------------|--------------|
| LOCK FRONT                                    |      |     | CODE        | PRICE        | DOOR THICKNESS                        |     | CODE        | PRICE        | ELECTRIFIED                                |     | CODE | PRICE       |              |
| 1-1/16" x 8"                                  | Q    | 27  |             |              | 50 mm (2")                            | D1  | NC          |              | 24V  | H1  |      |             |              |
| 1-1/16" x 5-5/8"                              | R    | 28  |             |              | 57 mm (2-1/4")                        | D2  | 44          |              | 12V  | H2  |      |             |              |
| 1-1/16" x 7-5/8"                              | T    | 27  |             |              | 60 mm (2-3/8")                        | D3  | 44          |              | Electrically locked                        | H9  |      |             |              |
| 1-1/4" x 10"                                  | U    | 109 |             |              | 1-3/4"                                | D4  | NC          |              | Electrically unlocked                      | H10 |      |             |              |
| 1" x 7-3/4"                                   | V    | 27  |             |              | 1-3/8"                                | D5  | NC          |              | <b>STRIKE</b>                              |     |      | <b>CODE</b> | <b>PRICE</b> |
| 1" x 7-1/8"                                   | W    | NC  |             |              | 1" - 1-1/4"                           | D6  | NC          |              | 4-7/8" ASA strike                          | S1  | 13   |             |              |
| 1-1/4" x 8"                                   | X    | 25  |             |              | 2" - 2-1/4"                           | D7  | 44          |              | Straight lip strike                        | S2  | 3    |             |              |
| 1-1/4" x 8-5/8"                               | Y    | 109 |             |              | 1-1/4" - 1-1/2"                       | D8  | NC          |              | 2-3/4" "T" strike                          | S3  | NC   |             |              |
| 1" x 8"                                       | Z    | 25  |             |              | Over 3"                               | D9  | 648         |              | 3-5/8" x 1-1/4" Security strike            | S4  | 11   |             |              |
| <b>TRIM MODIFICATIONS</b>                     |      |     | <b>CODE</b> | <b>PRICE</b> | 63.5 mm (2-1/2")                      | D10 | 71          |              | 2-1/4" Curved lip strike                   | S5  | NC   |             |              |
| Tactile knob/lever, coated ext. only          | A1   | 60  |             |              | 75 mm (3")                            | D11 | 90          |              | 4-7/8" Strikes: 1 Left / 1 Right           | S6  | 13   |             |              |
| Emergency coinkey                             | A2   | 28  |             |              | 72 mm (2-13/16")                      | D12 | 90          |              | Strike with 1-1/2" lip                     | S7  | 16   |             |              |
| Tamper-proof screws                           | A3   | 14  |             |              | 2-3/4"-3"                             | D14 | 300         |              | Radius corner strike                       | S8  | NC   |             |              |
| Tactile knob/lever, knurled                   | A4   | 60  |             |              | <b>LATCH</b>                          |     | <b>CODE</b> | <b>PRICE</b> | 4035-1 strike                              | S9  | NC   |             |              |
| Handicapped turnpiece                         | A5   | 18  |             |              | Solid latch                           | E1  | 20          |              | <b>TURNPIECES</b>                          |     |      | <b>CODE</b> | <b>PRICE</b> |
| Hotel indicator                               | A6   | 44  |             |              | Hold open latch                       | E2  | 37          |              | TP 1                                       | T1  | + 17 |             |              |
| Pinned knob                                   | A7   | 35  |             |              | Auxiliary latch                       | E3  | 35          |              | TP 3                                       | T3  | + 17 |             |              |
| Large rose 3-1/8" diameter                    | A8   | 11  |             |              | 2-3/4" backset, 1-1/8" x 2-1/4" face  | E4  | 10          |              | TP 4                                       | T4  | + 17 |             |              |
| Mushroom knob                                 | A9   | 5   |             |              | 2-3/8" backset, 1" x 2-1/4" face      | E6  | NC          |              | TP 5                                       | T5  | + 17 |             |              |
| No logo                                       | A10  | NC  |             |              | <b>TRIM CHANGES</b>                   |     | <b>CODE</b> | <b>PRICE</b> | TP 6                                       | T6  | + 17 |             |              |
| Engraved                                      | A11  | 71  |             |              | Lead lined                            | F1  | 325         |              | TP 7                                       | T7  | + 17 |             |              |
| Concealed cylinder                            | A12  | 27  |             |              | Large inside plate                    | F2  | 35          |              | TP 9                                       | T9  | + 17 |             |              |
| Dummy trim sub-assembly                       | A13  | —   |             |              | <b>Less inside trim**</b>             | F4  | NC          |              | TP 16                                      | T16 | + 17 |             |              |
| Coinkey w/ escutcheon plate                   | A14  | 71  |             |              | <b>Less outside trim**</b>            | F5  | NC          |              | <b>ELECTRONICS</b>                         |     |      | <b>CODE</b> | <b>PRICE</b> |
| Coinkey w/ rose                               | A15  | 71  |             |              | For 1-1/2" bore                       | F6  | 20          |              | Sensor array package: REX & key switch     | W1  | 333  |             |              |
| Occupancy Indicator                           | A17  | 90  |             |              | Adjustable spring collars             | F10 | 5           |              | Hard wired                                 | W5  | 26   |             |              |
| Tactile knob/lever, coated int. & ext.        | A18  | 122 |             |              | Corbin 6 pin IC core                  | F12 | 32          |              | Request to exit switch                     | W10 | 136  |             |              |
| BE 1-1/2" thick door adapter plate            | A19  | 78  |             |              | Corbin 7 pin IC core                  | F13 | 34          |              | Key sensor                                 | W11 | 136  |             |              |
| Rigid Lever                                   | A20  | NC  |             |              | Yale 6 pin IC core                    | F14 | 23          |              | Titan lever                                | W12 | 19   |             |              |
| "Tear Drop" occupancy indicator               | A21  | 79  |             |              | Yale 7 pin IC core                    | F15 | 23          |              | Request to EXit switch, key sensor         |     |      |             |              |
| Crescent Lever                                | A22  | NC  |             |              | Less outside knob/lever               | F16 |             |              | & bolt sensor                              | W13 | 428  |             |              |
| Square trim                                   | A23  | 29  |             |              | Dummy cylinder                        | F17 | 44          |              | <i>(W13 option for mortise locksets)</i>   |     |      |             |              |
| - Square collar                               | A23C | +10 |             |              | <b>Less outside trim w/ custom</b>    |     |             |              | Bolt sensor                                | W14 | 157  |             |              |
| - Square turnpiece                            | A23T | +10 |             |              | escutcheon**                          | F18 | NC          |              | Latch sensor                               | W15 | 157  |             |              |
| Small emergency hole                          | A24  | NC  |             |              | Schlage 6 pin IC core                 | F19 | 23          |              | REX + Latch sensor                         | W16 | 278  |             |              |
| SS55 Knob on EXT or INT (specify)             | A25  | 43  |             |              | Sargent IC core                       | F20 | 23          |              | <b>MISC</b>                                |     |      | <b>CODE</b> | <b>PRICE</b> |
| Plaza Lever                                   | A26  | NC  |             |              | Medeco IC core large format           | F21 | 23          |              | Please read special comments               | #   |      |             |              |
| Recessed Pull (one side)                      | A28  | 71  |             |              | IQ lead lined                         | F22 | 416         |              | regarding line item.                       |     |      |             |              |
| Exposed Rose Screws                           | A29  | NC  |             |              | Rigid Lever                           | F23 | NC          |              | <b>* Not available in CP plate design.</b> |     |      |             |              |
| Engraved and Filled                           | A30  | 81  |             |              | ASSA IC Core                          | F24 | 21          |              | <b>** Consult factory before ordering.</b> |     |      |             |              |
| Inside Knob on Lever                          | A31  | 35  |             |              | Blank Inside Plate/Lever              | F25 | NC          |              |  |     |      |             |              |
| No inside turnpiece                           | A32  | NC  |             |              | Blank Outside Plate/Lever             | F26 | NC          |              |  |     |      |             |              |
| <b>LOCK BODY</b> <i>Red, Green, BCC, Ind.</i> |      |     | <b>CODE</b> | <b>PRICE</b> | Yale 6 pin IC core w/ captivated tail | F27 | NC          |              |  |     |      |             |              |
| Lever override guard - outside*               | B1   | 44  |             |              | Yale 7 pin IC core w/ captivated tail | F28 | NC          |              |  |     |      |             |              |
| Lever override guard - both sides*            | B2   | 62  |             |              | Screwless Inside Escutcheon           | F29 | 30          |              |  |     |      |             |              |
| Hardened pins - deadbolt                      | B3   | 18  |             |              | <b>CYLINDER</b>                       |     | <b>CODE</b> | <b>PRICE</b> |  |     |      |             |              |
| Lever springs                                 | B4   | 19  |             |              | IC core housing - 7 Pin               | G1  | NC          |              |  |     |      |             |              |
| Pin and lever springs                         | B5   | 37  |             |              | Special optional keyway               | G2  | 37          |              |  |     |      |             |              |
| Hollow spacer                                 | B6   | 18  |             |              | Less cylinder                         | G3  | Deduct 15   |              |  |     |      |             |              |
| 8 mm hubs on square                           | B7   | 18  |             |              | MARKS "A" keyway                      | G4  | 14          |              |  |     |      |             |              |
| Turnpiece hub on square                       | B8   | 11  |             |              | MARKS "C" keyway                      | G5  | 16          |              |  |     |      |             |              |
| With deadbolt                                 | B9   | 18  |             |              | IC core housing w/9271 Collar - 6 Pin | G6  | NC          |              |  |     |      |             |              |
| Boxed Lock Body                               | B10  | NC  |             |              | IC core housing, Schlage large format |     |             |              |  |     |      |             |              |
| Lever spring outside only                     | B11  | NC  |             |              | (FOR MORTISE ONLY)                    | G7  | 80          |              |  |     |      |             |              |
| Lever spring inside only                      | B12  | NC  |             |              |                                       |     |             |              |  |     |      |             |              |





# BARRIER PLATE DESIGN BA

|  |   |   |   |                    |
|--|---|---|---|--------------------|
|                                       | <b>ANSI-A156.13 • Grade 1<br/>3 Hour Fire Rating</b>  |  | <b>Series 5 • 2-3/4" Backset<br/>Series 55 • 2-1/2" Backset</b> |                    |
|                                       | <b>Standard Features</b>  |   | <b>KNOBS</b>  | <b>LEVERS</b>      |
|  | <ul style="list-style-type: none"> <li>• Thru-bolted screwless knob/lever plate assemblies</li> <li>• Independent spring loaded captivated spindles</li> <li>• Reversible mortise lock 2-1/2" or 2-3/4" backset</li> <li>• Lever support springs</li> <li>• Lock front: 1-1/4" x 8"</li> <li>• Dimensions: Ext: 10-1/8" H x 4" W, Int: 10-3/4" H x 4" W</li> <li>• Cylinder: MARKS "C" keyway, 6 pin w/ 2 keys</li> </ul> |   | 10, 20  | 82, 83, 86, 92, 96 |
|  |   |   | <b>FINISH GROUPS</b>  |                    |
| <b>MARKS #</b>   | <b>FUNCTION</b>   | <b>ANSI #</b>   | <b>32D</b>  | <b>32D</b>         |
| <b>KEYED SINGLE CYLINDER, NO DEADBOLT</b>  |   |   |   |                    |
| D  | OFFICE VEST.  |   | 566   | 605                |
| DW   | VESTIBULE   |   |   |                    |
| E  | OFFICE  | F04   |   |                    |
| EW   | STOREROOM   | F07   |   |                    |
| J  | CLASSROOM   | F05   |   |                    |
| JM, JR   | HOSPITAL  | F06   |   |                    |
| GL   | INSTIT. PRIVACY   | F26   |   |                    |
| EL   | ELECTRICALLY LOCKED   |   | 932   | 972                |
| EU   | ELECTRICALLY UNLOCKED   |   |   |                    |
| <b>KEYED SINGLE CYLINDER, WITH DEADBOLT</b>  |   |   |   |                    |
| A  | ENTRANCE  | F08, F10  | 584   | 619                |
| B  | ENTRANCE  | F21   |   |                    |
| F  | DORMITORY   | F12   |   |                    |
| FS   | DORMITORY   |   |   |                    |
| FW   | DORMITORY   | F13   |   |                    |
| FD   | APARTMENT   | F20   | 609   | 648                |
| H  | HOTEL   | F15   |   |                    |
| LH   | SPECIAL PRIVACY   |   |   |                    |
| <b>KEYED DOUBLE CYLINDER, NO DEADBOLT</b>  |   |   |   |                    |
| G  | APARTMENT   | F09   | 618   | 658                |
| GC   | INTRUDER LATCHBOLT  | F32   |   |                    |
| GG   | CLASSROOM SECURITY  |   |   |                    |
| GR   | CLASSROOM SECURITY w/HOLDBACK   |   |   |                    |
| WW   | INSTITUTIONAL   | F30   |   |                    |
| <b>KEYED DOUBLE CYLINDER, WITH DEADBOLT</b>  |   |   |   |                    |
| AC   | ENTRANCE  | F35   | 620   | 658                |
| C  | STOREROOM   | F14   |   |                    |
| FC   | INTRUDER DEADBOLT   | F34   |   |                    |
| FA   | DORMITORY   | F11   |   |                    |
| FX   | DORMITORY   | F33   |   |                    |
|  |   |   |   |                    |
| <b>KEYLESS</b>   |   |   |   |                    |
| N  | PASSAGE   | F01   | 453   | 492                |
| L  | BATHROOM  | F02   | 584   | 619                |
| LF   | PRIVACY   | F19   |   |                    |
| LJ   | PRIVACY   | F22   | 514   | 551                |
| EX   | EXIT  | F31   |   |                    |
| <b>DUMMY TRIM</b>  |   |   |   |                    |
| DI   | DUMMY TRIM INSIDE   |   | 230   | 267                |
| DO   | DUMMY TRIM OUTSIDE  |   |   |                    |
| DT   | FULLY DUMMY   |   | 460   | 497                |
| <b>KNOB &amp; LEVERS ARE PACKED 6 PER CASE</b>   |   |   |   |                    |
| NOTE: Split designs and/or finishes are priced at the highest design and/or finish • Special finishes, consult factory |   |   |   |                    |



**KNOBS**

|               |   |
|---------------|---|
| Round Knob 10 |  |
| Ball Knob 20  |  |

**LEVERS**

|                                    |   |
|------------------------------------|---|
| Plaza Lever 82<br>Specify handing  |    |
| Dayton Lever 83<br>Specify handing |    |
| Crescent Lever 86                  |  |
| American Lever 92                  |  |
| Titan Lever 96                     |  |

# CLASSIC PLATE DESIGN CL

|  | ANSI-A156.13 • Grade 1<br>3 Hour Fire Rating   |  | Series 5 • 2-3/4" Backset<br>Series 55 • 2-1/2" Backset |         |   |         |
|---|--|---|---|---------|---|---------|
|  | Standard Features  |   | KNOBS   |         | LEVERS  |         |
|   | <ul style="list-style-type: none"> <li>• Thru-bolted screwless knob/lever plate assemblies</li> <li>• Independent spring loaded captivated spindles</li> <li>• Reversible mortise lock 2-1/2" or 2-3/4" backset</li> <li>• Lever support springs</li> <li>• Lock front: 1-1/4" x 8"</li> <li>• Dimensions: Ext: 8" H x 2-1/2" W, Int: 8" H x 2-1/2" W</li> <li>• Cylinder: MARKS "C" keyway, 6 pin w/ 2 keys</li> <li>• Height: 7/32"</li> </ul> |   | 10, 20  |         | 031, 44, 55, 57,<br>72, 77, 78, 82,<br>83, 86, 92, 96 |         |
|   | FINISH GROUPS  |   |   |         |   |         |
| MARKS #   | FUNCTION   | ANSI #  | 3, 26D, 32D   | 10, 10B | 3E, 10, 26D, 32D                                      | 10B, 32 |
| <b>KEYED SINGLE CYLINDER, NO DEADBOLT</b>   |  |   |   |         |   |         |
| D   | OFFICE VEST.   |   | 613   | 650     | 756   | 793     |
| DW  | VESTIBULE  |   |   |         |   |         |
| E   | OFFICE   | F04   |   |         |   |         |
| EW  | STOREROOM  | F07   |   |         |   |         |
| J   | CLASSROOM  | F05   |   |         |   |         |
| JM, JR  | HOSPITAL   | F06   |   |         |   |         |
| GL  | INSTIT. PRIVACY  | F26   |   |         |   |         |
| EL  | ELECTRICALLY LOCKED  |   | 929   | 966     | 1072  | 1109    |
| EU  | ELECTRICALLY UNLOCKED  |   |   |         |   |         |
| <b>KEYED SINGLE CYLINDER, WITH DEADBOLT</b>                                       |  |   |   |         |   |         |
| A   | ENTRANCE   | F08, F10  | 626   | 664     | 770   | 807     |
| B   | ENTRANCE   | F21   |   |         |   |         |
| F   | DORMITORY  | F12   |   |         |   |         |
| FS  | DORMITORY  |   |   |         |   |         |
| FW  | DORMITORY  | F13   |   |         |   |         |
| FD  | APARTMENT  | F20   | 688   | 725     | 831   | 868     |
| H   | HOTEL  | F15   |   |         |   |         |
| LH  | SPECIAL PRIVACY  |   |   |         |   |         |
| <b>KEYED DOUBLE CYLINDER, NO DEADBOLT</b>   |  |   |   |         |   |         |
| G   | APARTMENT  | F09   | 660   | 697     | 803   | 841     |
| GC  | INTRUDER LATCHBOLT   | F32   |   |         |   |         |
| GG  | CLASSROOM SECURITY   |   |   |         |   |         |
| GR  | CLASSROOM SECURITY w/HOLDBACK  |   |   |         |   |         |
| WW  | INSTITUTIONAL  | F30   |   |         |   |         |
| <b>KEYED DOUBLE CYLINDER, WITH DEADBOLT</b>                                       |  |   |   |         |   |         |
| AC  | ENTRANCE   | F35   | 660   | 697     | 803   | 841     |
| C   | STOREROOM  | F14   |   |         |   |         |
| FC  | INTRUDER DEADBOLT  | F34   |   |         |   |         |
| FA  | DORMITORY  | F11   |   |         |   |         |
| FX  | DORMITORY  | F33   |   |         |   |         |
| <b>KEYLESS</b>  |  |   |   |         |   |         |
| N   | PASSAGE  | F01   | 515   | 552     | 658   | 695     |
| L   | BATHROOM   | F02   | 628   | 665     | 771   | 808     |
| LF  | PRIVACY  | F19   |   |         |   |         |
| LJ  | PRIVACY  | F22   | 567   | 604     | 710   | 747     |
| EX  | EXIT   | F31   | 567   | 604     | 710   | 747     |
| <b>DUMMY TRIM</b>   |  |   |   |         |   |         |
| DI  | DUMMY TRIM INSIDE  |   | 258   | 277     | 330   | 348     |
| DO  | DUMMY TRIM OUTSIDE   |   |   |         |   |         |
| DT  | FULLY DUMMY  |   | 516   | 553     | 659   | 690     |

**KNOBS & LEVERS ARE PACKED 6 PER CASE**



NOTE: Split designs and/or finishes are priced at the highest design and/or finish • Special finishes, consult factory

# CLASSIC PLATE DESIGN CL

|   |  |               |  |                |   |                |
|---|--|---------------|--|----------------|---|----------------|
|    | <b>ANSI-A156.13 • Grade 2</b>  |               | <b>Series 7 • 2-3/4" Backset</b><br><b>Series 9 • 2-1/2" Backset</b> |                |   |                |
|   | <b>Standard Features</b>   |               | <b>KNOBS</b>   |                | <b>LEVERS</b>   |                |
|   | <ul style="list-style-type: none"> <li>• Thru-bolted screwless knob/lever plate assemblies</li> <li>• Independent spring loaded captivated spindles</li> <li>• Reversible mortise lock 2-1/2" or 2-3/4" backset</li> <li>• Lever support springs</li> <li>• Lock front Series 7: 1-1/4" x 8", Series 9: 1-1/16" x 7-5/8"</li> <li>• Dimensions: Ext: 8" H x 2-1/2" W, Int: 8" H x 2-1/2" W</li> <li>• Cylinder: MARKS "C" keyway, 6 pin w/ 2 keys</li> </ul> |               | 10, 20   |                | 031, 44, 55, 57,<br>72, 77, 78, 82,<br>83, 86, 92, 96 |                |
| <b>FINISH GROUPS</b>  |  |               |  |                |   |                |
| <b>MARKS #</b>  | <b>FUNCTION</b>  | <b>ANSI #</b> | <b>3, 26D, 32D</b>   | <b>10, 10B</b> | <b>3E, 10, 26D, 32D</b>                               | <b>10B, 32</b> |
| <b>KEYED SINGLE CYLINDER, NO DEADBOLT</b>   |  |               |  |                |   |                |
| D   | OFFICE VEST.   |               | 581  | 618            | 724   | 761            |
| DW  | VESTIBULE  |               |  |                |   |                |
| <b>KEYED SINGLE CYLINDER, WITH DEADBOLT</b>   |  |               |  |                |   |                |
| A   | ENTRANCE   | F08, F10      | 595  | 629            | 738   | 775            |
| B   | ENTRANCE   | F21           |  |                |   |                |
| F   | DORMITORY  | F12           |  |                |   |                |
| FS  | DORMITORY  |               |  |                |   |                |
| FW  | DORMITORY  | F13           |  |                |   |                |
| <b>KEYED DOUBLE CYLINDER, WITH DEADBOLT</b>   |  |               |  |                |   |                |
| AC  | ENTRANCE   | F35           | 629  | 666            | 772   | 809            |
| C   | STOREROOM  | F14           |  |                |   |                |
| FX  | DORMITORY  | F33           |  |                |   |                |
| <b>KEYLESS</b>  |  |               |  |                |   |                |
| N   | PASSAGE  | F01           | 483  | 520            | 626   | 664            |
| L   | BATHROOM   | F02           | 596  | 633            | 739   | 776            |
| LF  | PRIVACY  | F19           |  |                |   |                |
| <b>DUMMY TRIM</b>   |  |               |  |                |   |                |
| DI  | DUMMY TRIM INSIDE  |               | 259  | 277            | 330   | 349            |
| DO  | DUMMY TRIM OUTSIDE   |               |  |                |   |                |
| DT  | FULLY DUMMY  |               | 516  | 553            | 659   | 696            |
| <b>NOTE: Split designs and/or finishes are priced at the highest design and/or finish • Special finishes, consult factory</b> |  |               |  |                |   |                |

|               |   |   |  |   |  |  |
|---------------|---|---|--|---|--|--|
| <b>KNOBS</b>  | Round Knob 10   | Ball Knob 20  |  |   |  |  |
|               |  |  |  |   |  |  |
| <b>LEVERS</b> | Stanhope Lever 44   | Copa Lever 031  | Brompton Lever 55  | Monaco Lever 57<br>Specify handing  |  |  |
|               |  |  |  |  |  |  |
|               | Towne Lever 72  | Maxwell Lever 77  | Omni Lever 78  | Plaza Lever 82<br>Specify handing   |  |  |
|               |  |  |  |  |  |  |
|               | Dayton Lever 83<br>Specify handing  | Crescent Lever 86   | American Lever 92  | Titan Lever 96  |  |  |
|               |  |  |   |  |  |  |

# CAPITOL PLATE DESIGN CP

|  |   | ANSI-A156.13 • Grade 1<br>3 Hour Fire Rating |  | Series 5 • 2-3/4" Backset<br>Series 55 • 2-1/2" Backset |   |                            |
|---|---|--|---|---|---|----------------------------|
|  | Standard Features   |  | KNOBS   |   | LEVERS  |                            |
|   | <ul style="list-style-type: none"> <li>• Thru-bolted screwless knob/lever plate assemblies</li> <li>• Independent spring loaded captivated spindles</li> <li>• Reversible mortise lock 2-1/2" or 2-3/4" backset</li> <li>• Lever support springs</li> <li>• Lock front: 1-1/4" x 8"</li> <li>• Dimensions:<br/>Ext: 8-1/2" H x 2-3/4" W, Int: 8-1/2" H x 2-3/4" W</li> <li>• Cylinder: MARKS "C" keyway, 6 pin w/ 2 keys</li> <li>• Concealed 5 pin cylinder (option A12)</li> <li>• Thickness: 1/8"</li> </ul> |  | 10, 20  |   | 031, 44, 55, 57,<br>72, 77, 78, 82,<br>83, 86, 92, 96 | 031, 82, 83,<br>86, 92, 96 |
| FINISH GROUPS   |   |  |   |   |   |                            |
| MARKS #   | FUNCTION  | ANSI #                                       | 3, 32D  | 10, 10B   | 3, 32D  | 10, 10B                    |
| <b>KEYED SINGLE CYLINDER, NO DEADBOLT</b>   |   |  |   |   |   |                            |
| D   | OFFICE VEST.  |  | 638   | 675   | 781   | 818                        |
| DW  | VESTIBULE   |  |   |   |   |                            |
| E   | OFFICE  | F04  |   |   |   |                            |
| EW  | STOREROOM   | F07  |   |   |   |                            |
| J   | CLASSROOM   | F05  |   |   |   |                            |
| JM, JR  | HOSPITAL  | F06  |   |   |   |                            |
| GL  | INSTIT. PRIVACY   | F26  |   |   |   |                            |
| EL  | ELECTRICALLY LOCKED   |  | 954   | 991   | 1097  | 1134                       |
| EU  | ELECTRICALLY UNLOCKED   |  |   |   |   |                            |
| <b>KEYED SINGLE CYLINDER, WITH DEADBOLT</b>                                       |   |  |   |   |   |                            |
| A   | ENTRANCE  | F08, F10                                     | 651   | 689   | 795   | 832                        |
| B   | ENTRANCE  | F21  |   |   |   |                            |
| F   | DORMITORY   | F12  |   |   |   |                            |
| FS  | DORMITORY   |  |   |   |   |                            |
| FW  | DORMITORY   | F13  |   |   |   |                            |
| FD  | APARTMENT   | F20  | 713   | 750   | 856   | 894                        |
| H   | HOTEL   | F15  |   |   |   |                            |
| LH  | SPECIAL PRIVACY   |  |   |   |   |                            |
| <b>KEYED DOUBLE CYLINDER, NO DEADBOLT</b>   |   |  |   |   |   |                            |
| G   | APARTMENT   | F09  | 686   | 723   | 829   | 866                        |
| GC  | INTRUDER LATCHBOLT  | F32  |   |   |   |                            |
| GG  | CLASSROOM SECURITY  |  |   |   |   |                            |
| GR  | CLASSROOM SECURITY w/HOLDBACK   |  |   |   |   |                            |
| WW  | INSTITUTIONAL   | F30  |   |   |   |                            |
| <b>KEYED DOUBLE CYLINDER, WITH DEADBOLT</b>                                       |   |  |   |   |   |                            |
| AC  | ENTRANCE  | F35  | 686   | 723   | 829   | 866                        |
| C   | STOREROOM   | F14  |   |   |   |                            |
| FC  | INTRUDER DEADBOLT   | F34  |   |   |   |                            |
| FA  | DORMITORY   | F11  |   |   |   |                            |
| FX  | DORMITORY   | F33  |   |   |   |                            |
| <b>KEYLESS</b>  |   |  |   |   |   |                            |
| N   | PASSAGE   | F01  | 541   | 578   | 684   | 721                        |
| L   | BATHROOM  | F02  | 653   | 690   | 796   | 833                        |
| LF  | PRIVACY   | F19  |   |   |   |                            |
| LJ  | PRIVACY   | F22  | 593   | 630   | 736   | 773                        |
| EX  | EXIT  | F31  | 593   | 630   | 736   | 773                        |
| <b>DUMMY TRIM</b>   |   |  |   |   |   |                            |
| DI  | DUMMY TRIM INSIDE   |  | 271   | 289   | 342   | 361                        |
| DO  | DUMMY TRIM OUTSIDE  |  |   |   |   |                            |
| DT  | FULLY DUMMY   |  | 541   | 579   | 685   | 722                        |

**KNOBS & LEVERS ARE PACKED 6 PER CASE**



NOTE: Split designs and/or finishes are priced at the highest design and/or finish • Special finishes, consult factory

# CAPITOL PLATE DESIGN CP

|   |  |               |  |                      |   |                |  |
|---|--|---------------|--|----------------------|---|----------------|--|
|    | <b>ANSI-A156.13 • Grade 2</b>  |               | <b>Series 7 • 2-3/4" Backset</b><br><b>Series 9 • 2-1/2" Backset</b> |                      |   |                |  |
|   | <b>Standard Features</b>   |               | <b>KNOBS</b>   |                      | <b>LEVERS</b>   |                |  |
|   | <ul style="list-style-type: none"> <li>• Thru-bolted screwless knob/lever plate assemblies</li> <li>• Independent spring loaded captivated spindles</li> <li>• Reversible mortise lock 2-1/2" or 2-3/4" backset • Lever support springs</li> <li>• Lock front Series 7: 1-1/4" x 8", Series 9: 1-1/16" x 7-5/8"</li> <li>• Dimensions: Ext: 8-1/2" H x 2-3/4" W, Int: 8-1/2" H x 2-3/4" W</li> <li>• Cylinder: MARKS "C" keyway, 6 pin w/ 2 keys</li> <li>• Concealed 5 pin cylinder (option A12)</li> </ul> |               | 10, 20   |                      | 031, 44, 55, 57,<br>72, 77, 78, 82,<br>83, 86, 92, 96 |                |  |
|   |  |               |  | <b>FINISH GROUPS</b> |   |                |  |
| <b>MARKS #</b>  | <b>FUNCTION</b>  | <b>ANSI #</b> | <b>3, 32D</b>  | <b>10,10B</b>        | <b>3, 32D</b>   | <b>10, 10B</b> |  |
| <b>KEYED SINGLE CYLINDER, NO DEADBOLT</b>   |  |               |  |                      |   |                |  |
| D   | OFFICE VEST.   |               | 606  | 643                  | 749   | 787            |  |
| DW  | VESTIBULE  |               |  |                      |   |                |  |
| <b>KEYED SINGLE CYLINDER, WITH DEADBOLT</b>   |  |               |  |                      |   |                |  |
| A   | ENTRANCE   | F08, F10      | 620  | 657                  | 763   | 800            |  |
| B   | ENTRANCE   | F21           |  |                      |   |                |  |
| F   | DORMITORY  | F12           |  |                      |   |                |  |
| FS  | DORMITORY  |               |  |                      |   |                |  |
| FW  | DORMITORY  | F13           |  |                      |   |                |  |
| <b>KEYED DOUBLE CYLINDER, WITH DEADBOLT</b>   |  |               |  |                      |   |                |  |
| AC  | ENTRANCE   | F35           | 654  | 691                  | 797   | 834            |  |
| C   | STOREROOM  | F14           |  |                      |   |                |  |
| FX  | DORMITORY  | F33           |  |                      |   |                |  |
| <b>KEYLESS</b>  |  |               |  |                      |   |                |  |
| N   | PASSAGE  | F01           | 509  | 546                  | 652   | 689            |  |
| L   | BATHROOM   | F02           | 621  | 658                  | 764   | 801            |  |
| LF  | PRIVACY  | F19           |  |                      |   |                |  |
| <b>DUMMY TRIM</b>   |  |               |  |                      |   |                |  |
| DI  | DUMMY TRIM INSIDE  |               | 270  | 289                  | 342   | 361            |  |
| DO  | DUMMY TRIM OUTSIDE   |               |  |                      |   |                |  |
| DT  | FULLY DUMMY  |               | 542  | 579                  | 685   | 722            |  |
| <b>NOTE: Split designs and/or finishes are priced at the highest design and/or finish • Special finishes, consult factory</b> |  |               |  |                      |   |                |  |

|               |   |   |  |   |                 |  |
|---------------|---|---|--|---|-----------------|--|
| <b>KNOBS</b>  | Round Knob 10   | Ball Knob 20  |  |   |                 |  |
|               |  |  |  |   |                 |  |
| <b>LEVERS</b> | Stanhope Lever 44   | Copa Lever 031  | Brompton Lever 55  | Monaco Lever 57   | Specify handing |  |
|               |  |  |  |  |                 |  |
|               | Towne Lever 72  | Maxwell Lever 77  | Omni Lever 78  | Plaza Lever 82  | Specify handing |  |
|               |  |  |  |  |                 |  |
|               | Dayton Lever 83   | Crescent Lever 86   | American Lever 92  | Titan Lever 96  |                 |  |
|               |  |  |  |  |                 |  |
|               | Specify handing   |   |  |   |                 |  |

# CROWN PLATE DESIGN CR

|  |   | ANSI-A156.13 • Grade 1<br>3 Hour Fire Rating |  |                | Series 5 • 2-3/4" Backset<br>Series 55 • 2-1/2" Backset |                |   |                         |                               |
|---|---|--|---|----------------|---|----------------|---|-------------------------|-------------------------------|
|  | Standard Features   |  | KNOBS   |                |   | LEVERS         |   |                         |                               |
|   | <ul style="list-style-type: none"> <li>• Thru-bolted screwless knob/lever plate assemblies</li> <li>• Independent spring loaded captivated spindles</li> <li>• Reversible mortise lock 2-1/2" or 2-3/4" backset</li> <li>• Lever support springs • Lock front: 1-1/4" x 8"</li> <li>• Dimensions: Ext: 8-1/2" H x 2" W, Int: 8-1/2" H x 2" W</li> <li>• Cylinder: MARKS "C" keyway, 6 pin w/ 2 keys</li> <li>• Concealed 5 pin cylinder (option A12)</li> <li>• Height: 13/32"</li> <li>• Square Edges</li> </ul> |  | 10, 20  |                | 30, 60  |                | 031, 44, 55, 57,<br>72, 77, 78, 82,<br>83, 86, 92, 96 |                         | 031, 82,<br>83, 86,<br>92, 96 |
| FINISH GROUPS   |   |  |   |                |   |                |   |                         |                               |
| MARKS #   | FUNCTION  | ANSI #                                       | 3, 26D,<br>32D  | 10, 10B,<br>32 | 3E, 15,<br>26D  | 10, 10B,<br>14 | 3E, 15,<br>26D  | 10, 10B, 14,<br>19E, 26 | 32, 32D                       |
| <b>KEYED SINGLE CYLINDER, NO DEADBOLT</b>   |   |  |   |                |   |                |   |                         |                               |
| D   | OFFICE VEST.  |  |   |                |   |                |   |                         |                               |
| DW  | VESTIBULE   |  |   |                |   |                |   |                         |                               |
| E   | OFFICE  | F04  |   |                |   |                |   |                         |                               |
| EW  | STOREROOM   | F07  | 659   | 696            | 700   | 737            | 759   | 833                     | 796                           |
| J   | CLASSROOM   | F05  |   |                |   |                |   |                         |                               |
| JM, JR  | HOSPITAL  | F06  |   |                |   |                |   |                         |                               |
| GL  | INSTIT. PRIVACY   | F26  |   |                |   |                |   |                         |                               |
| EL  | ELECTRICALLY LOCKED   |  | 975   | 1012           | 1015  | 1038           | 1060  | 1134                    | 1097                          |
| EU  | ELECTRICALLY UNLOCKED   |  |   |                |   |                |   |                         |                               |
| <b>KEYED SINGLE CYLINDER, WITH DEADBOLT</b>                                       |   |  |   |                |   |                |   |                         |                               |
| A   | ENTRANCE  | F08, F10                                     |   |                |   |                |   |                         |                               |
| B   | ENTRANCE  | F21  |   |                |   |                |   |                         |                               |
| F   | DORMITORY   | F12  | 673   | 710            | 713   | 750            | 773   | 847                     | 810                           |
| FS  | DORMITORY   |  |   |                |   |                |   |                         |                               |
| FW  | DORMITORY   | F13  |   |                |   |                |   |                         |                               |
| FD  | APARTMENT   | F20  |   |                |   |                |   |                         |                               |
| H   | HOTEL   | F15  | 694   | 731            | 735   | 772            | 794   | 868                     | 831                           |
| LH  | SPECIAL PRIVACY   |  |   |                |   |                |   |                         |                               |
| <b>KEYED DOUBLE CYLINDER, NO DEADBOLT</b>   |   |  |   |                |   |                |   |                         |                               |
| G   | APARTMENT   | F09  |   |                |   |                |   |                         |                               |
| GC  | INTRUDER LATCHBOLT  | F32  |   |                |   |                |   |                         |                               |
| GG  | CLASSROOM SECURITY  |  | 703   | 740            | 743   | 780            | 802   | 877                     | 840                           |
| GR  | CLASSROOM SECURITY w/HOLDBACK   |  |   |                |   |                |   |                         |                               |
| WW  | INSTITUTIONAL   | F30  |   |                |   |                |   |                         |                               |
| <b>KEYED DOUBLE CYLINDER, WITH DEADBOLT</b>                                       |   |  |   |                |   |                |   |                         |                               |
| AC  | ENTRANCE  | F35  |   |                |   |                |   |                         |                               |
| C   | STOREROOM   | F14  |   |                |   |                |   |                         |                               |
| FC  | INTRUDER DEADBOLT   | F34  | 703   | 740            | 743   | 780            | 802   | 877                     | 840                           |
| FA  | DORMITORY   | F11  |   |                |   |                |   |                         |                               |
| FX  | DORMITORY   | F33  |   |                |   |                |   |                         |                               |
| <b>KEYLESS</b>  |   |  |   |                |   |                |   |                         |                               |
| N   | PASSAGE   | F01  | 566   | 603            | 607   | 643            | 666   | 740                     | 703                           |
| L   | BATHROOM  | F02  | 673   | 710            | 713   | 750            | 773   | 847                     | 810                           |
| LF  | PRIVACY   | F19  |   |                |   |                |   |                         |                               |
| LJ  | PRIVACY   | F22  | 616   | 653            | 656   | 693            | 716   | 790                     | 753                           |
| EX  | EXIT  | F31  |   |                |   |                |   |                         |                               |
| <b>DUMMY TRIM</b>   |   |  |   |                |   |                |   |                         |                               |
| DI  | DUMMY TRIM INSIDE   |  | 283   | 304            | 306   | 324            | 336   | 391                     | 354                           |
| DO  | DUMMY TRIM OUTSIDE  |  |   |                |   |                |   |                         |                               |
| DT  | FULLY DUMMY   |  | 571   | 608            | 612   | 649            | 671   | 745                     | 708                           |

**KNOBS & LEVERS ARE PACKED 6 PER CASE**

NOTE: Split designs and/or finishes are priced at the highest design and/or finish • Special finishes, consult factory





# CROWN PLATE DESIGN CR

|    | ANSI-A156.13 • Grade 2   |          | Series 7 • 2-3/4" Backset<br>Series 9 • 2-1/2" Backset |                |                |                |   |                         |                               |  |  |
|---|--|----------|--|----------------|----------------|----------------|---|-------------------------|-------------------------------|--|--|
|   | Standard Features  |          | KNOBS  |                |                |                | LEVERS  |                         |                               |  |  |
|   | <ul style="list-style-type: none"> <li>• Thru-bolted screwless knob/lever plate</li> <li>• Independent spring loaded captivated spindles</li> <li>• Reversible mortise lock 2-1/2" or 2-3/4" backset</li> <li>• Lever support springs</li> <li>• Lock front Series 7: 1-1/4" x 8", Series 9: 1-1/16" x 7-5/8"</li> <li>• Dimensions: Ext: 8-1/2" H x 2" W, Int: 8-1/2" H x 2" W</li> <li>• Cylinder: MARKS "C" keyway, 6 pin w/ 2 keys</li> <li>• Concealed 5 pin cylinder (option A12)</li> </ul> |          | 10, 20   |                | 30, 60         |                | 031, 44, 55, 57,<br>72, 77, 78, 82,<br>83, 86, 92, 96 |                         | 031, 82,<br>83, 86,<br>92, 96 |  |  |
| MARKS #   | FUNCTION   | ANSI #   | FINISH GROUPS  |                |                |                |   |                         |                               |  |  |
|   |  |          | 3,<br>26D, 32D   | 10, 10B,<br>32 | 3E, 15,<br>26D | 10, 10B,<br>14 | 3E, 15,<br>26D  | 10, 10B, 14,<br>19E, 26 | 32,<br>32D                    |  |  |
| <b>KEYED SINGLE CYLINDER, NO DEADBOLT</b>   |  |          |  |                |                |                |   |                         |                               |  |  |
| D   | OFFICE VEST.   |          | 628  | 665            | 668            | 705            | 727   | 801                     | 764                           |  |  |
| DW  | VESTIBULE  |          |  |                |                |                |   |                         |                               |  |  |
| <b>KEYED SINGLE CYLINDER, WITH DEADBOLT</b>   |  |          |  |                |                |                |   |                         |                               |  |  |
| A   | ENTRANCE   | F08, F10 | 641  | 678            | 682            | 718            | 741   | 815                     | 778                           |  |  |
| B   | ENTRANCE   | F21      |  |                |                |                |   |                         |                               |  |  |
| F   | DORMITORY  | F12      |  |                |                |                |   |                         |                               |  |  |
| FS  | DORMITORY  |          |  |                |                |                |   |                         |                               |  |  |
| <b>KEYED DOUBLE CYLINDER, WITH DEADBOLT</b>   |  |          |  |                |                |                |   |                         |                               |  |  |
| AC  | ENTRANCE   | F35      | 671  | 708            | 711            | 748            | 771   | 845                     | 808                           |  |  |
| C   | STOREROOM  | F14      |  |                |                |                |   |                         |                               |  |  |
| FX  | DORMITORY  | F33      |  |                |                |                |   |                         |                               |  |  |
| <b>KEYLESS</b>  |  |          |  |                |                |                |   |                         |                               |  |  |
| N   | PASSAGE  | F01      | 534  | 571            | 575            | 612            | 634   | 708                     | 671                           |  |  |
| L   | BATHROOM   | F02      | 641  | 678            | 682            | 719            | 741   | 815                     | 778                           |  |  |
| LF  | PRIVACY  | F19      |  |                |                |                |   |                         |                               |  |  |
| <b>DUMMY TRIM</b>   |  |          |  |                |                |                |   |                         |                               |  |  |
| DI  | DUMMY TRIM INSIDE  |          | 286  | 304            | 306            | 324            | 336   | 391                     | 354                           |  |  |
| DO  | DUMMY TRIM OUTSIDE   |          |  |                |                |                |   |                         |                               |  |  |
| DT  | FULLY DUMMY  |          |  |                |                |                |   |                         |                               |  |  |
| <b>NOTE: Split designs and/or finishes are priced at the highest design and/or finish • Special finishes, consult factory</b> |  |          |  |                |                |                |   |                         |                               |  |  |

| KNOBS   | Round Knob 10   | Ball Knob 20   | Ball Knob 30  | Eclipse Knob 60   |   |
|---|---|--|---|---|---|
|   |  |   |    |  |   |
|   | LEVERS  | Stanhope Lever 44  | Copa Lever 031  | Brompton Lever 55   | Monaco Lever 57<br>Specify handing  |
|   |   |   |    |   |  |
| Towne Lever 72  |   | Maxwell Lever 77   | Omni Lever 78   | Plaza Lever 82<br>Specify handing   |   |
|  |   |   |   |  |   |
| Dayton Lever 83<br>Specify handing  | Crescent Lever 86   | American Lever 92  | Titan Lever 96  |   |   |
|  |  |  |  |   |   |

# DRAKE PLATE DESIGN DR

|  |  | ANSI-A156.13 • Grade 1<br>3 Hour Fire Rating |  |                |                |                |   |                          |                               | Series 5 • 2-3/4" Backset<br>Series 55 • 2-1/2" Backset |
|---|--|--|---|----------------|----------------|----------------|---|--------------------------|-------------------------------|---|
|  | Standard Features  |  | KNOBS   |                |                |                | LEVERS  |                          |                               |   |
|   | <ul style="list-style-type: none"> <li>• Thru-bolted screwless knob/lever plate</li> <li>• Independent spring loaded captivated spindles</li> <li>• Reversible mortise lock 2-1/2" or 2-3/4" backset</li> <li>• Lever support springs</li> <li>• Lock front: 1-1/4" x 8"</li> <li>• Dimensions: Ext: 11" H x 2-1/2" W, Int: 11" H x 2-1/2" W</li> <li>• Cylinder: MARKS "C" keyway, 6 pin w/ 2 keys</li> <li>• Concealed 5 pin cylinder (option A12)</li> <li>• Height: 13/32" • Square Edges</li> </ul> |  | 10, 20  |                | 30, 60         |                | 031, 44, 55, 57,<br>72, 77, 78, 82,<br>83, 86, 92, 96 |                          | 031, 82,<br>83, 86,<br>92, 96 |   |
| FINISH GROUPS   |  |  |   |                |                |                |   |                          |                               |   |
| MARKS #   | FUNCTION   | ANSI #                                       | 3, 26D,<br>32D  | 10, 10B,<br>32 | 3E, 15,<br>26D | 10, 10B,<br>14 | 3E, 15,<br>26D  | 10E, 10B,<br>14, 19E, 26 | 32, 32D                       |   |
| <b>KEYED SINGLE CYLINDER, NO DEADBOLT</b>   |  |  |   |                |                |                |   |                          |                               |   |
| D   | OFFICE VEST.   |  |   |                |                |                |   |                          |                               |   |
| DW  | VESTIBULE  |  |   |                |                |                |   |                          |                               |   |
| E   | OFFICE   | F04  |   |                |                |                |   |                          |                               |   |
| EW  | STOREROOM  | F07  | 728   | 765            | 769            | 806            | 828   | 902                      | 865                           |   |
| J   | CLASSROOM  | F05  |   |                |                |                |   |                          |                               |   |
| JM, JR  | HOSPITAL   | F06  |   |                |                |                |   |                          |                               |   |
| GL  | INSTIT. PRIVACY  | F26  |   |                |                |                |   |                          |                               |   |
| EL  | ELECTRICALLY LOCKED  |  | 1044  | 1081           | 1084           | 1106           | 1129  | 1203                     | 1166                          |   |
| EU  | ELECTRICALLY UNLOCKED  |  |   |                |                |                |   |                          |                               |   |
| <b>KEYED SINGLE CYLINDER, WITH DEADBOLT</b>                                       |  |  |   |                |                |                |   |                          |                               |   |
| A   | ENTRANCE   | F08, F10                                     |   |                |                |                |   |                          |                               |   |
| B   | ENTRANCE   | F21  |   |                |                |                |   |                          |                               |   |
| F   | DORMITORY  | F12  | 742   | 779            | 782            | 819            | 842   | 916                      | 879                           |   |
| FS  | DORMITORY  |  |   |                |                |                |   |                          |                               |   |
| FW  | DORMITORY  | F13  |   |                |                |                |   |                          |                               |   |
| FD  | APARTMENT  | F20  |   |                |                |                |   |                          |                               |   |
| H   | HOTEL  | F15  | 763   | 800            | 803            | 841            | 862   | 937                      | 900                           |   |
| LH  | SPECIAL PRIVACY  |  |   |                |                |                |   |                          |                               |   |
| <b>KEYED DOUBLE CYLINDER, NO DEADBOLT</b>   |  |  |   |                |                |                |   |                          |                               |   |
| G   | APARTMENT  | F09  |   |                |                |                |   |                          |                               |   |
| GC  | INTRUDER LATCHBOLT   | F32  |   |                |                |                |   |                          |                               |   |
| GG  | CLASSROOM SECURITY   |  | 772   | 809            | 812            | 849            | 871   | 946                      | 908                           |   |
| GR  | CLASSROOM SECURITY w/HOLDBACK  |  |   |                |                |                |   |                          |                               |   |
| WW  | INSTITUTIONAL  | F30  |   |                |                |                |   |                          |                               |   |
| <b>KEYED DOUBLE CYLINDER, WITH DEADBOLT</b>                                       |  |  |   |                |                |                |   |                          |                               |   |
| AC  | ENTRANCE   | F35  |   |                |                |                |   |                          |                               |   |
| C   | STOREROOM  | F14  |   |                |                |                |   |                          |                               |   |
| FC  | INTRUDER DEADBOLT  | F34  | 772   | 809            | 812            | 849            | 871   | 946                      | 908                           |   |
| FA  | DORMITORY  | F11  |   |                |                |                |   |                          |                               |   |
| FX  | DORMITORY  | F33  |   |                |                |                |   |                          |                               |   |
| <b>KEYLESS</b>  |  |  |   |                |                |                |   |                          |                               |   |
| N   | PASSAGE  | F01  | 635   | 672            | 675            | 712            | 735   | 809                      | 772                           |   |
| L   | BATHROOM   | F02  |   |                |                |                |   |                          |                               |   |
| LF  | PRIVACY  | F19  | 742   | 779            | 782            | 819            | 842   | 916                      | 879                           |   |
| LJ  | PRIVACY  | F22  |   |                |                |                |   |                          |                               |   |
| EX  | EXIT   | F31  | 685   | 722            | 725            | 762            | 784   | 859                      | 822                           |   |
| <b>DUMMY TRIM</b>   |  |  |   |                |                |                |   |                          |                               |   |
| DI  | DUMMY TRIM INSIDE  |  | 320   | 339            | 340            | 359            | 370   | 426                      | 389                           |   |
| DO  | DUMMY TRIM OUTSIDE   |  |   |                |                |                |   |                          |                               |   |
| DT  | FULLY DUMMY  |  | 640   | 677            | 680            | 718            | 740   | 814                      | 777                           |   |

**KNOBS & LEVERS ARE PACKED 6 PER CASE**



NOTE: Split designs and/or finishes are priced at the highest design and/or finish • Special finishes, consult factory

# DRAKE PLATE DESIGN DR

|   |  |               |  |                        |                        |                        |   |                                  |                               |
|---|--|---------------|--|------------------------|------------------------|------------------------|---|----------------------------------|-------------------------------|
|    | ANSI-A156.13 • Grade 2   |               | Series 7 • 2-3/4" Backset<br>Series 9 • 2-1/2" Backset |                        |                        |                        |   |                                  |                               |
|   | <b>Standard Features</b>   |               | <b>KNOBBS</b>  |                        |                        |                        | <b>LEVERS</b>   |                                  |                               |
|   | <ul style="list-style-type: none"> <li>• Thru-bolted screwless knob/lever plate</li> <li>• Independent spring loaded captivated spindles</li> <li>• Reversible mortise lock 2-1/2" or 2-3/4" backset</li> <li>• Lever support springs</li> <li>• Lock front Series 7: 1-1/4" x 8", Series 9: 1-1/16" x 7-5/8"</li> <li>• Dimensions: Ext: 11" H x 2-1/2" W, Int: 11" H x 2-1/2" W</li> <li>• Cylinder: MARKS "C" keyway, 6 pin w/ 2 keys</li> <li>• Concealed 5 pin cylinder (option A12)</li> </ul> |               | 10, 20   |                        | 30, 60                 |                        | 031, 44, 55, 57,<br>72, 77, 78, 82,<br>83, 86, 92, 96 |                                  | 031, 82,<br>83, 86,<br>92, 96 |
| <b>FINISH GROUPS</b>  |  |               |  |                        |                        |                        |   |                                  |                               |
| <b>MARKS #</b>  | <b>FUNCTION</b>  | <b>ANSI #</b> | <b>3, 26D,<br/>32D</b>                                 | <b>10, 10B,<br/>32</b> | <b>3E, 15,<br/>26D</b> | <b>10, 10B,<br/>14</b> | <b>3E, 15,<br/>26D</b>                                | <b>10E, 10B,<br/>14, 19E, 26</b> | <b>32, 32D</b>                |
| <b>KEYED SINGLE CYLINDER, NO DEADBOLT</b>   |  |               |  |                        |                        |                        |   |                                  |                               |
| D   | OFFICE VEST.   |               | 696  | 734                    | 737                    | 774                    | 796   | 870                              | 833                           |
| DW  | VESTIBULE  |               |  |                        |                        |                        |   |                                  |                               |
| <b>KEYED SINGLE CYLINDER, WITH DEADBOLT</b>   |  |               |  |                        |                        |                        |   |                                  |                               |
| A   | ENTRANCE   | F08, F10      |  |                        |                        |                        |   |                                  |                               |
| B   | ENTRANCE   | F21           | 710  | 747                    | 750                    | 788                    | 810   | 884                              | 847                           |
| F   | DORMITORY  | F12           |  |                        |                        |                        |   |                                  |                               |
| FS  | DORMITORY  |               |  |                        |                        |                        |   |                                  |                               |
| <b>KEYED DOUBLE CYLINDER, WITH DEADBOLT</b>   |  |               |  |                        |                        |                        |   |                                  |                               |
| AC  | ENTRANCE   | F35           |  |                        |                        |                        |   |                                  |                               |
| C   | STOREROOM  | F14           | 740  | 777                    | 780                    | 817                    | 840   | 914                              | 877                           |
| FX  | DORMITORY  | F33           |  |                        |                        |                        |   |                                  |                               |
| <b>KEYLESS</b>  |  |               |  |                        |                        |                        |   |                                  |                               |
| N   | PASSAGE  | F01           | 603  | 640                    | 643                    | 681                    | 703   | 777                              | 740                           |
| L   | BATHROOM   | F02           | 710  | 747                    | 750                    | 788                    | 810   | 884                              | 847                           |
| LF  | PRIVACY  | F19           |  |                        |                        |                        |   |                                  |                               |
| <b>DUMMY TRIM</b>   |  |               |  |                        |                        |                        |   |                                  |                               |
| DI  | DUMMY TRIM INSIDE  |               | 320  | 339                    | 340                    | 359                    | 370   | 426                              | 389                           |
| DO  | DUMMY TRIM OUTSIDE   |               |  |                        |                        |                        |   |                                  |                               |
| DT  | FULLY DUMMY  |               | 640  | 667                    | 681                    | 718                    | 740   | 814                              | 777                           |
| <b>NOTE: Split designs and/or finishes are priced at the highest design and/or finish • Special finishes, consult factory</b> |  |               |  |                        |                        |                        |   |                                  |                               |

|               |   |   |  |   |
|---------------|---|---|--|---|
| <b>KNOBBS</b> | Round Knob 10   | Ball Knob 20  | Ball Knob 30   | Eclipse Knob 60   |
|               |  |  |   |  |
|               | Stanhope Lever 44   | Copa Lever 031  | Brompton Lever 55  | Monaco Lever 57<br>Specify handing  |
|               |  |  |  |  |
| <b>LEVERS</b> | Towne Lever 72  | Maxwell Lever 77  | Omni Lever 78  | Plaza Lever 82<br>Specify handing   |
|               |  |  |  |  |
|               | Dayton Lever 83<br>Specify handing  | Crescent Lever 86   | American Lever 92  | Titan Lever 96  |
|               |  |  |  |  |

# DAVOS PLATE DESIGN DV











| <b>BHMA</b><br>CERTIFIED  |   | ANSI-A156.13 • Grade 1<br>3 Hour Fire Rating |  |                | Series 5 • 2-3/4" Backset<br>Series 55 • 2-1/2" Backset |                |   |                          |  |
|---|---|--|---|----------------|---|----------------|---|--------------------------|--|
|  | <b>Standard Features</b>  |  | <b>KNOBS</b>  |                |   | <b>LEVERS</b>  |   |                          |  |
|   | <ul style="list-style-type: none"> <li>• Thru-bolted screwless knob/lever plate</li> <li>• Independent spring loaded captivated spindles</li> <li>• Reversible mortise lock 2-1/2" or 2-3/4" backset</li> <li>• Lever support springs</li> <li>• Lock front: 1-1/4" x 8"</li> <li>• Dimensions: Ext: 11" H x 2-1/2" W, Int: 11" H x 2-1/2" W</li> <li>• Cylinder: MARKS "C" keyway, 6 pin w/ 2 keys</li> <li>• Concealed 5 pin cylinder (option A12)</li> <li>• Height: 13/32" • Bevel Edges</li> </ul> |  | 10, 20  |                | 30, 60  |                | 031, 44, 55, 57,<br>72, 77, 78, 82,<br>83, 86, 92, 96 |                          |  |
|   |   | <b>FINISH GROUPS</b>                         |   |                |   |                |   |                          |  |
| MARKS #   | FUNCTION  | ANSI #                                       | 3, 26D,<br>32D  | 10, 10B,<br>32 | 3E, 15, 26D   | 10, 10B,<br>14 | 3E, 15, 26D   | 10E, 10B, 14,<br>19E, 26 |  |
| <b>KEYED SINGLE CYLINDER, NO DEADBOLT</b>   |   |  |   |                |   |                |   |                          |  |
| D   | OFFICE VEST.  |  |   |                |   |                |   |                          |  |
| DW  | VESTIBULE   |  |   |                |   |                |   |                          |  |
| E   | OFFICE  | F04  |   |                |   |                |   |                          |  |
| EW  | STOREROOM   | F07  | 798   | 835            | 838   | 876            | 898   | 972                      |  |
| J   | CLASSROOM   | F05  |   |                |   |                |   |                          |  |
| JM, JR  | HOSPITAL  | F06  |   |                |   |                |   |                          |  |
| GL  | INSTIT. PRIVACY   | F26  |   |                |   |                |   |                          |  |
| EL  | ELECTRICALLY LOCKED   |  | 1114  | 1151           | 1154  | 1177           | 1197  | 1273                     |  |
| EU  | ELECTRICALLY UNLOCKED   |  |   |                |   |                |   |                          |  |
| <b>KEYED SINGLE CYLINDER, WITH DEADBOLT</b>                                       |   |  |   |                |   |                |   |                          |  |
| A   | ENTRANCE  | F08, F10                                     |   |                |   |                |   |                          |  |
| B   | ENTRANCE  | F21  |   |                |   |                |   |                          |  |
| F   | DORMITORY   | F12  | 812   | 849            | 852   | 889            | 911   | 986                      |  |
| FS  | DORMITORY   |  |   |                |   |                |   |                          |  |
| FW  | DORMITORY   | F13  |   |                |   |                |   |                          |  |
| FD  | APARTMENT   | F20  |   |                |   |                |   |                          |  |
| H   | HOTEL   | F15  | 833   | 870            | 873   | 911            | 933   | 1007                     |  |
| LH  | SPECIAL PRIVACY   |  |   |                |   |                |   |                          |  |
| <b>KEYED DOUBLE CYLINDER, NO DEADBOLT</b>   |   |  |   |                |   |                |   |                          |  |
| G   | APARTMENT   | F09  |   |                |   |                |   |                          |  |
| GC  | INTRUDER LATCHBOLT  | F32  |   |                |   |                |   |                          |  |
| GG  | CLASSROOM SECURITY  |  | 842   | 879            | 882   | 919            | 941   | 1015                     |  |
| GR  | CLASSROOM SECURITY w/HOLDBACK   |  |   |                |   |                |   |                          |  |
| WW  | INSTITUTIONAL   | F30  |   |                |   |                |   |                          |  |
| <b>KEYED DOUBLE CYLINDER, WITH DEADBOLT</b>                                       |   |  |   |                |   |                |   |                          |  |
| AC  | ENTRANCE  | F35  |   |                |   |                |   |                          |  |
| C   | STOREROOM   | F14  |   |                |   |                |   |                          |  |
| FC  | INTRUDER DEADBOLT   | F34  | 842   | 879            | 882   | 919            | 941   | 1015                     |  |
| FA  | DORMITORY   | F11  |   |                |   |                |   |                          |  |
| FX  | DORMITORY   | F33  |   |                |   |                |   |                          |  |
| <b>KEYLESS</b>  |   |  |   |                |   |                |   |                          |  |
| N   | PASSAGE   | F01  | 705   | 742            | 745   | 782            | 805   | 879                      |  |
| L   | BATHROOM  | F02  |   |                |   |                |   |                          |  |
| LF  | PRIVACY   | F19  | 812   | 849            | 852   | 889            | 912   | 986                      |  |
| LJ  | PRIVACY   | F22  |   |                |   |                |   |                          |  |
| EX  | EXIT  | F31  | 755   | 792            | 795   | 832            | 918   | 929                      |  |
| <b>DUMMY TRIM</b>   |   |  |   |                |   |                |   |                          |  |
| DI  | DUMMY TRIM INSIDE   |  | 355   | 374            | 375   | 394            | 405   | 449                      |  |
| DO  | DUMMY TRIM OUTSIDE  |  |   |                |   |                |   |                          |  |
| DT  | FULLY DUMMY   |  | 710   | 747            | 750   | 788            | 810   | 884                      |  |

**KNOBS & LEVERS ARE PACKED 6 PER CASE**



NOTE: Split designs and/or finishes are priced at the highest design and/or finish • Special finishes, consult factory

# DAVOS PLATE DESIGN DV

|   |  |               |  |            |             |               |   |                          |
|---|--|---------------|--|------------|-------------|---------------|---|--------------------------|
|    | <b>ANSI-A156.13 • Grade 2</b>  |               | <b>Series 7 • 2-3/4" Backset</b><br><b>Series 9 • 2-1/2" Backset</b> |            |             |               |   |                          |
|   | <b>Standard Features</b>   |               | <b>KNOBS</b>   |            |             | <b>LEVERS</b> |   |                          |
|   | <ul style="list-style-type: none"> <li>• Thru-bolted screwless knob/lever plate</li> <li>• Independent spring loaded captivated spindles</li> <li>• Reversible mortise lock 2-1/2" or 2-3/4" backset</li> <li>• Lever support springs</li> <li>• Lock front Series 7: 1-1/4" x 8", Series 9: 1-1/16" x 7-5/8"</li> <li>• Dimensions: Ext: 11" H x 2-1/2" W, Int: 11" H x 2-1/2" W</li> <li>• Cylinder: MARKS "C" keyway, 6 pin w/ 2 keys</li> <li>• Concealed 5 pin cylinder (option A12)</li> </ul> |               | 10, 20   |            | 30, 60      |               | 031, 44, 55, 57,<br>72, 77, 78, 82,<br>83, 86, 92, 96 |                          |
| <b>FINISH GROUPS</b>  |  |               |  |            |             |               |   |                          |
| <b>MARKS #</b>  | <b>FUNCTION</b>  | <b>ANSI #</b> | 3, 26D, 32D  | 10, 10B,32 | 3E, 15, 26D | 10, 10B,14    | 3E, 15, 26D   | 10E, 10B, 14,<br>19E, 26 |
| <b>KEYED SINGLE CYLINDER, NO DEADBOLT</b>   |  |               |  |            |             |               |   |                          |
| D   | OFFICE VEST.   |               | 766  | 803        | 807         | 844           | 866   | 940                      |
| DW  | VESTIBULE  |               |  |            |             |               |   |                          |
| <b>KEYED SINGLE CYLINDER, WITH DEADBOLT</b>   |  |               |  |            |             |               |   |                          |
| A   | ENTRANCE   | F08, F10      | 780  | 817        | 820         | 858           | 880   | 954                      |
| B   | ENTRANCE   | F21           |  |            |             |               |   |                          |
| F   | DORMITORY  | F12           |  |            |             |               |   |                          |
| FS  | DORMITORY  |               |  |            |             |               |   |                          |
| <b>KEYED DOUBLE CYLINDER, WITH DEADBOLT</b>   |  |               |  |            |             |               |   |                          |
| AC  | ENTRANCE   | F35           | 810  | 847        | 850         | 887           | 909   | 984                      |
| C   | STOREROOM  | F14           |  |            |             |               |   |                          |
| FX  | DORMITORY  | F33           |  |            |             |               |   |                          |
| <b>KEYLESS</b>  |  |               |  |            |             |               |   |                          |
| N   | PASSAGE  | F01           | 673  | 710        | 713         | 750           | 723   | 847                      |
| L   | BATHROOM   | F02           | 780  | 817        | 820         | 855           | 880   | 954                      |
| LF  | PRIVACY  | F19           |  |            |             |               |   |                          |
| <b>DUMMY TRIM</b>   |  |               |  |            |             |               |   |                          |
| DI  | DUMMY TRIM INSIDE  |               | 355  | 374        | 375         | 394           | 405   | 461                      |
| DO  | DUMMY TRIM OUTSIDE   |               |  |            |             |               |   |                          |
| DT  | FULLY DUMMY  |               | 710  | 737        | 750         | 788           | 810   | 884                      |
| <b>NOTE: Split designs and/or finishes are priced at the highest design and/or finish • Special finishes, consult factory</b> |  |               |  |            |             |               |   |                          |

|               |   |   |  |   |
|---------------|---|---|--|---|
| <b>KNOBS</b>  | Round Knob 10   | Ball Knob 20  | Ball Knob 30   | Eclipse Knob 60   |
|               |  |  |   |  |
|               | Stanhope Lever 44   | Copa Lever 031  | Brompton Lever 55  | Monaco Lever 57<br>Specify handing  |
|               |  |  |  |  |
| <b>LEVERS</b> | Towne Lever 72  | Maxwell Lever 77  | Omni Lever 78  | Plaza Lever 82<br>Specify handing   |
|               |  |  |  |  |
|               | Dayton Lever 83<br>Specify handing  | Crescent Lever 86   | American Lever 92  | Titan Lever 96  |
|               |  |  |   |  |

# MADISON PLATE DESIGN MA

|  | ANSI-A156.13 • Grade 1<br>3 Hour Fire Rating  |          |  | Series 5 • 2-3/4" Backset<br>Series 55 • 2-1/2" Backset |   |
|---|---|----------|---|---|---|
|  | Standard Features   |          |   | KNOB  | LEVER   |
|   | <ul style="list-style-type: none"> <li>• Thru-bolted screwless knob/lever plate assemblies</li> <li>• Independent spring loaded captivated spindles</li> <li>• Reversible mortise lock 2-1/2" or 2-3/4" backset</li> <li>• Lever support springs</li> <li>• Lock front: 1-1/4" x 8"</li> <li>• Dimensions: Ext: 10-1/2" H x 2-5/32" W, Int: 10-1/2" H x 2-5/32" W</li> <li>• Cylinder: MARKS "C" keyway, 6 pin w/ 2 keys</li> <li>• Height: 13/32"</li> </ul> |          |   | 30, 60  | 031, 44, 55, 57,<br>72, 77, 78, 82,<br>83, 86, 92, 96 |
| FINISH GROUPS   |   |          |   |   |   |
| MARKS #   | FUNCTION  | ANSI #   | 3E & 15   | 3E & 15   | 3E & 15   |
| <b>KEYED SINGLE CYLINDER, NO DEADBOLT</b>   |   |          |   |   |   |
| D   | OFFICE VEST.  |          |   |   |   |
| DW  | VESTIBULE   |          |   |   |   |
| E   | OFFICE  | F04      |   |   |   |
| EW  | STOREROOM   | F07      | 844   | 880   |   |
| J   | CLASSROOM   | F05      |   |   |   |
| JM, JR  | HOSPITAL  | F06      |   |   |   |
| GL  | INSTIT. PRIVACY   | F26      |   |   |   |
| EL  | ELECTRICALLY LOCKED   |          | 1177  | 1212  |   |
| EU  | ELECTRICALLY UNLOCKED   |          |   |   |   |
| <b>KEYED SINGLE CYLINDER, WITH DEADBOLT</b>                                       |   |          |   |   |   |
| A   | ENTRANCE  | F08, F10 |   |   |   |
| B   | ENTRANCE  | F21      |   |   |   |
| F   | DORMITORY   | F12      | 860   | 895   |   |
| FS  | DORMITORY   |          |   |   |   |
| FW  | DORMITORY   | F13      |   |   |   |
| FD  | APARTMENT   | F20      | 883   | 916   |   |
| H   | HOTEL   | F15      |   |   |   |
| LH  | SPECIAL PRIVACY   |          |   |   |   |
| <b>KEYED DOUBLE CYLINDER, NO DEADBOLT</b>   |   |          |   |   |   |
| G   | APARTMENT   | F09      |   |   |   |
| GC  | INTRUDER LATCHBOLT  | F32      |   |   |   |
| GG  | CLASSROOM SECURITY  |          | 891   | 928   |   |
| GR  | CLASSROOM SECURITY w/HOLDBACK   |          |   |   |   |
| WW  | INSTITUTIONAL   | F30      |   |   |   |
| <b>KEYED DOUBLE CYLINDER, WITH DEADBOLT</b>                                       |   |          |   |   |   |
| AC  | ENTRANCE  | F35      |   |   |   |
| C   | STOREROOM   | F14      |   |   |   |
| FC  | INTRUDER DEADBOLT   | F34      | 891   | 928   |   |
| FA  | DORMITORY   | F11      |   |   |   |
| FX  | DORMITORY   | F33      |   |   |   |
|   |   |          |   |   |   |
| <b>KEYLESS</b>  |   |          |   |   |   |
| N   | PASSAGE   | F01      | 742   | 776   |   |
| L   | BATHROOM  | F02      | 860   | 895   |   |
| LF  | PRIVACY   | F19      |   |   |   |
| LJ  | PRIVACY   | F22      | 796   | 832   |   |
| EX  | EXIT  | F31      |   |   |   |
| <b>DUMMY TRIM</b>   |   |          |   |   |   |
| DI  | DUMMY TRIM INSIDE   |          | 374   | 406   |   |
| DO  | DUMMY TRIM OUTSIDE  |          |   |   |   |
| DT  | FULLY DUMMY   |          | 747   | 782   |   |

**KNOB & LEVER ARE PACKED 6 PER CASE**



NOTE: Split designs and/or finishes are priced at the highest design and/or finish • Special finishes, consult factory

# MADISON PLATE DESIGN MA



|   |  |               |  |   |
|---|--|---------------|--|---|
|  | <b>ANSI-A156.13 • Grade 2</b>  |               | <b>Series 7 • 2-3/4" Backset</b><br><b>Series 9 • 2-1/2" Backset</b> |   |
|   | <b>Standard Features</b>   |               | <b>KNOBS</b>   | <b>LEVERS</b>   |
|   | <ul style="list-style-type: none"> <li>• Thru-bolted screwless knob/lever plate assemblies</li> <li>• Independent spring loaded captivated spindles</li> <li>• Reversible mortise lock 2-1/2" or 2-3/4" backset</li> <li>• Lever support springs</li> <li>• Lock front Series 7: 1-1/4" x 8", Series 9: 1-1/16" x 7-5/8"</li> <li>• Dimensions: Ext: 10-1/2" H x 2-5/32" W, Int: 10-1/2" H x 2-5/32" W</li> <li>• Cylinder: MARKS "C" keyway, 6 pin w/ 2 keys</li> <li>• Height: 13/32"</li> </ul> |               | 30, 60   | 031, 44, 55, 57,<br>72, 77, 78, 82,<br>83, 86, 92, 96 |
| <b>MARKS #</b>  | <b>FUNCTION</b>  | <b>ANSI #</b> | <b>3E &amp; 15</b>   | <b>3E &amp; 15</b>                                    |
| <b>KEYED SINGLE CYLINDER, NO DEADBOLT</b>   |  |               |  |   |
| D   | OFFICE VEST.   |               | 810  | 845   |
| DW  | VESTIBULE  |               |  |   |
| <b>KEYED SINGLE CYLINDER, WITH DEADBOLT</b>                                       |  |               |  |   |
| A   | ENTRANCE   | F08, F10      | 825  | 860   |
| B   | ENTRANCE   | F21           |  |   |
| F   | DORMITORY  | F12           |  |   |
| FS  | DORMITORY  |               |  |   |
| FW  | DORMITORY  | F13           |  |   |
| <b>KEYED DOUBLE CYLINDER, WITH DEADBOLT</b>                                       |  |               |  |   |
| AC  | ENTRANCE   | F35           | 858  | 893   |
| C   | STOREROOM  | F14           |  |   |
| FX  | DORMITORY  | F33           |  |   |
| <b>KEYLESS</b>  |  |               |  |   |
| N   | PASSAGE  | F01           | 707  | 742   |
| L   | BATHROOM   | F02           | 825  | 860   |
| LF  | PRIVACY  | F19           |  |   |
| <b>DUMMY TRIM</b>   |  |               |  |   |
| DI  | DUMMY TRIM INSIDE  |               | 374  | 406   |
| DO  | DUMMY TRIM OUTSIDE   |               |  |   |
| DT  | FULLY DUMMY  |               | 747  | 782   |

**KNOBS & LEVERS ARE PACKED 6 PER CASE**

NOTE: Split designs and/or finishes are priced at the highest design and/or finish • Special finishes, consult factory

|               |   |   |  |   |
|---------------|---|---|--|---|
| <b>KNOBS</b>  | Ball Knob 30  | Eclipse Knob 60   |  |   |
|               |  |  |  |   |
| <b>LEVERS</b> | Stanhope Lever 44   | Copa Lever 031  | Brompton Lever 55  | Monaco Lever 57<br>Specify handing  |
|               |  |  |  |  |
|               | Towne Lever 72  | Maxwell Lever 77  | Omni Lever 78  | Plaza Lever 82<br>Specify handing   |
|               |  |  |  |  |
|               | Dayton Lever 83<br>Specify handing  | Crescent Lever 86   | American Lever 92  | Titan Lever 96  |
|               |  |  |  |  |

# NEW YORKER PLATE DESIGN NY

|   |                               | ANSI-A156.13 • Grade 1<br>3 Hour Fire Rating |     |  |     | Series 5 • 2-3/4" Backset<br>Series 55 • 2-1/2" Backset |     |  |   |     |
|--|-------------------------------|--|-----|---|-----|---|-----|--|---|-----|
|   |                               | Standard Features                            |     | KNOBS   |     | LEVERS  |     |  |   |     |
| <ul style="list-style-type: none"> <li>• Thru-bolted screwless knob/lever plate assemblies</li> <li>• Independent spring loaded captivated spindles</li> <li>• Reversible mortise lock 2-1/2" or 2-3/4" backset</li> <li>• Lever support springs</li> <li>• Lock front: 1-1/4" x 8"</li> <li>• Dimensions: Ext: 10" H x 2-3/4" W, *Int: 7" H x 2-1/4" W</li> <li>• Cylinder: MARKS "C" keyway, 6 pin w/ 2 keys</li> <li>• Thickness: 1/4"</li> </ul> |                               |  |     | 10, 20  |     | 30, 60  |     | 031, 44, 55,<br>57, 72, 77,<br>78, 82, 83,<br>86, 92, 96 |   |     |
| FINISH GROUPS  |                               |  |     |   |     |   |     |  |   |     |
| MARKS #  | FUNCTION                      | ANSI #                                       | 3   | 26D   | 3   | 26D   | 3   | 26D  | 3 | 26D |
| <b>KEYED SINGLE CYLINDER, NO DEADBOLT</b>  |                               |  |     |   |     |   |     |  |   |     |
| D  | OFFICE VEST.                  |  |     |   |     |   |     |  |   |     |
| DW   | VESTIBULE                     |  |     |   |     |   |     |  |   |     |
| E  | OFFICE                        | F04  |     |   |     |   |     |  |   |     |
| EW   | STOREROOM                     | F07  | 419 | 457   | 474 | 511   | 516 | 554  |   |     |
| J  | CLASSROOM                     | F05  |     |   |     |   |     |  |   |     |
| JM, JR   | HOSPITAL                      | F06  |     |   |     |   |     |  |   |     |
| GL   | INSTIT. PRIVACY               | F26  |     |   |     |   |     |  |   |     |
| EL   | ELECTRICALLY LOCKED           |  | 767 | 806   | 823 | 860   | 865 | 903  |   |     |
| EU   | ELECTRICALLY UNLOCKED         |  |     |   |     |   |     |  |   |     |
| <b>KEYED SINGLE CYLINDER, WITH DEADBOLT</b>  |                               |  |     |   |     |   |     |  |   |     |
| A  | ENTRANCE                      | F08, F10                                     |     |   |     |   |     |  |   |     |
| B  | ENTRANCE                      | F21  |     |   |     |   |     |  |   |     |
| F  | DORMITORY                     | F12  | 436 | 471   | 491 | 528   | 533 | 571  |   |     |
| FS   | DORMITORY                     |  |     |   |     |   |     |  |   |     |
| FW   | DORMITORY                     | F13  |     |   |     |   |     |  |   |     |
| FD   | APARTMENT                     | F20  |     |   |     |   |     |  |   |     |
| H  | HOTEL                         | F15  | 460 | 498   | 515 | 552   | 558 | 596  |   |     |
| LH   | SPECIAL PRIVACY               |  |     |   |     |   |     |  |   |     |
| <b>KEYED DOUBLE CYLINDER, NO DEADBOLT</b>  |                               |  |     |   |     |   |     |  |   |     |
| G  | APARTMENT                     | F09  |     |   |     |   |     |  |   |     |
| GC   | INTRUDER LATCHBOLT            | F32  |     |   |     |   |     |  |   |     |
| GG   | CLASSROOM SECURITY            |  | 469 | 516   | 524 | 561   | 566 | 604  |   |     |
| GR   | CLASSROOM SECURITY w/HOLDBACK |  |     |   |     |   |     |  |   |     |
| WW   | INSTITUTIONAL                 | F30  |     |   |     |   |     |  |   |     |
| <b>KEYED DOUBLE CYLINDER, WITH DEADBOLT</b>  |                               |  |     |   |     |   |     |  |   |     |
| AC   | ENTRANCE                      | F35  |     |   |     |   |     |  |   |     |
| C  | STOREROOM                     | F14  |     |   |     |   |     |  |   |     |
| FC   | INTRUDER DEADBOLT             | F34  | 469 | 507   | 524 | 561   | 566 | 604  |   |     |
| FA   | DORMITORY                     | F11  |     |   |     |   |     |  |   |     |
| FX   | DORMITORY                     | F33  |     |   |     |   |     |  |   |     |
| <b>KEYLESS</b>   |                               |  |     |   |     |   |     |  |   |     |
| N  | PASSAGE                       | F01  | 311 | 349   | 366 | 403   | 408 | 446  |   |     |
| L  | BATHROOM                      | F02  | 436 | 471   | 491 | 528   | 533 | 571  |   |     |
| LF   | PRIVACY                       | F19  |     |   |     |   |     |  |   |     |
| LJ   | PRIVACY                       | F22  | 369 | 407   | 424 | 461   | 466 | 505  |   |     |
| EX   | EXIT                          | F31  |     |   |     |   |     |  |   |     |
| <b>DUMMY TRIM</b>  |                               |  |     |   |     |   |     |  |   |     |
| DI   | DUMMY TRIM INSIDE             |  | 159 | 178   | 187 | 205   | 210 | 248  |   |     |
| DO   | DUMMY TRIM OUTSIDE            |  |     |   |     |   |     |  |   |     |
| DT   | FULLY DUMMY                   |  | 317 | 355   | 372 | 409   | 414 | 453  |   |     |

**KNOBS & LEVERS ARE PACKED 6 PER CASE**

NOTE: Split designs and/or finishes are priced at the highest design and/or finish • Special finishes, consult factory

\* Large interior plate available (10" H x 2-3/4" W)





# NEW YORKER PLATE DESIGN NY

|  |  |               |  |            |          |               |  |            |
|--|--|---------------|--|------------|----------|---------------|--|------------|
|                                       | <b>ANSI-A156.13 • Grade 2</b>  |               | <b>Series 7 • 2-3/4" Backset</b><br><b>Series 9 • 2-1/2" Backset</b> |            |          |               |  |            |
|  | <b>Standard Features</b>   |               | <b>KNOB</b>  |            |          | <b>LEVERS</b> |  |            |
|  | <ul style="list-style-type: none"> <li>• Thru-bolted screwless knob/lever plate assemblies</li> <li>• Independent spring loaded captivated spindles</li> <li>• Reversible mortise lock 2-1/2" or 2-3/4" backset</li> <li>• Lever support springs</li> <li>• Lock front Series 7: 1-1/4" x 8"; Series 9: 1-1/16" x 7-5/8"</li> <li>• Dimensions: Ext: 10" H x 2-3/4" W, *Int: 7" H x 2-1/4" W</li> <li>• Cylinder: MARKS "C" keyway, 6 pin w/ 2 keys</li> </ul> |               | 10, 20   |            | 30, 60   |               | 031, 44, 55,<br>57, 72, 77,<br>78, 82, 83,<br>86, 92, 96 |            |
| <b>MARKS #</b>   | <b>FUNCTION</b>  | <b>ANSI #</b> | <b>FINISH GROUPS</b>   |            |          |               |  |            |
|  |  |               | <b>3</b>   | <b>26D</b> | <b>3</b> | <b>26D</b>    | <b>3</b>   | <b>26D</b> |
| <b>KEYED SINGLE CYLINDER, NO DEADBOLT</b>  |  |               |  |            |          |               |  |            |
| D  | OFFICE VEST.   |               | 387  | 425        | 442      | 479           | 495  | 533        |
| DW   | VESTIBULE  |               |  |            |          |               |  |            |
| <b>KEYED SINGLE CYLINDER, WITH DEADBOLT</b>  |  |               |  |            |          |               |  |            |
| A  | ENTRANCE   | F08, F10      | 404  | 439        | 459      | 496           | 501  | 540        |
| B  | ENTRANCE   | F21           |  |            |          |               |  |            |
| F  | DORMITORY  | F12           |  |            |          |               |  |            |
| FS   | DORMITORY  |               |  |            |          |               |  |            |
| FW   | DORMITORY  | F13           |  |            |          |               |  |            |
| <b>KEYED DOUBLE CYLINDER, WITH DEADBOLT</b>  |  |               |  |            |          |               |  |            |
| AC   | ENTRANCE   | F35           | 437  | 475        | 492      | 529           | 534  | 572        |
| C  | STOREROOM  | F14           |  |            |          |               |  |            |
| FX   | DORMITORY  | F33           |  |            |          |               |  |            |
| <b>KEYLESS</b>   |  |               |  |            |          |               |  |            |
| N  | PASSAGE  | F01           | 279  | 317        | 334      | 371           | 376  | 414        |
| L  | BATHROOM   | F02           | 404  | 439        | 459      | 496           | 545  | 583        |
| LF   | PRIVACY  | F19           |  |            |          |               |  |            |
| <b>DUMMY TRIM</b>  |  |               |  |            |          |               |  |            |
| DI   | DUMMY TRIM INSIDE  |               | 159  | 178        | 187      | 205           | 210  | 248        |
| DO   | DUMMY TRIM OUTSIDE   |               |  |            |          |               |  |            |
| DT   | FULLY DUMMY  |               | 317  | 343        | 372      | 409           | 414  | 453        |
| <b>KNOB &amp; LEVERS ARE PACKED 6 PER CASE</b>   |  |               |  |            |          |               |  |            |
| NOTE: Split designs and/or finishes are priced at the highest design and/or finish • Special finishes, consult factory |  |               |  |            |          |               |  |            |
| * Large interior plate available (10" H x 2-3/4" W)  |  |               |  |            |          |               |  |            |

|              |   |   |  |   |
|--------------|---|---|--|---|
| <b>KNOB</b>  | Round Knob 10   | Ball Knob 20  | Ball Knob 30   | Eclipse Knob 60   |
|              |  |  |   |  |
|              | Stanhope Lever 44   | Copa Lever 031  | Brompton Lever 55  | Monaco Lever 57<br>Specify handing  |
|              |  |  |  |  |
| <b>LEVER</b> | Towne Lever 72  | Maxwell Lever 77  | Omni Lever 78  | Plaza Lever 82<br>Specify handing   |
|              |  |  |  |  |
|              | Dayton Lever 83<br>Specify handing  | Crescent Lever 86   | American Lever 92  | Titan Lever 96  |
|              |  |  |   |  |

# TOWNE PLATE DESIGN TN

|                                       |  | ANSI-A156.13 • Grade 1<br>3 Hour Fire Rating |  | Series 5 • 2-3/4" Backset<br>Series 55 • 2-1/2" Backset |   |         |      |
|--|--|--|---|---|---|---------|------|
|                                       | Standard Features  |  | KNOBS   |   | LEVERS  |         |      |
|  | <ul style="list-style-type: none"> <li>• Thru-bolted screwless knob/lever plate assemblies</li> <li>• Independent spring loaded captivated spindles</li> <li>• Reversible mortise lock 2-1/2" or 2-3/4" backset</li> <li>• Lever support springs</li> <li>• Lock front: 1-1/4" x 8"</li> <li>• Dimensions: Ext: 9-1/4" H x 2-1/4" W, Int: 9-1/4" H x 2-1/4" W</li> <li>• Cylinder: MARKS "C" keyway, 6 pin w/ 2 keys</li> <li>• Thickness: 13/32"</li> </ul> |  | 30, 60  |   | 031, 44, 55, 57,<br>72, 77, 78, 82,<br>83, 86, 92, 96 |         |      |
| MARKS #  |  | FUNCTION                                     | ANSI #  | 3E & 15   | 26  | 3E & 15 | 26   |
| <b>KEYED SINGLE CYLINDER, NO DEADBOLT</b>  |  |  |   |   |   |         |      |
| D  | OFFICE VEST.   |  |   | 844   | 881   | 889     | 928  |
| DW   | VESTIBULE  |  |   |   |   |         |      |
| E  | OFFICE   | F04  |   |   |   |         |      |
| EW   | STOREROOM  | F07  |   |   |   |         |      |
| J  | CLASSROOM  | F05  |   |   |   |         |      |
| JM, JR   | HOSPITAL   | F06  |   |   |   |         |      |
| GL   | INSTIT. PRIVACY  | F26  |   |   |   |         |      |
| EL   | ELECTRICALLY LOCKED  |  |   | 1194  | 1231  | 1238    | 1276 |
| EU   | ELECTRICALLY UNLOCKED  |  |   |   |   |         |      |
| <b>KEYED SINGLE CYLINDER, WITH DEADBOLT</b>  |  |  |   |   |   |         |      |
| A  | ENTRANCE   | F08, F10                                     |   | 861   | 898   | 906     | 942  |
| B  | ENTRANCE   | F21  |   |   |   |         |      |
| F  | DORMITORY  | F12  |   |   |   |         |      |
| FS   | DORMITORY  |  |   |   |   |         |      |
| FW   | DORMITORY  | F13  |   |   |   |         |      |
| FD   | APARTMENT  | F20  |   | 885   | 919   | 823     | 967  |
| H  | HOTEL  | F15  |   |   |   |         |      |
| LH   | SPECIAL PRIVACY  |  |   |   |   |         |      |
| <b>KEYED DOUBLE CYLINDER, NO DEADBOLT</b>  |  |  |   |   |   |         |      |
| G  | APARTMENT  | F09  |   | 895   | 932   | 940     | 977  |
| GC   | INTRUDER LATCHBOLT   | F32  |   |   |   |         |      |
| GG   | CLASSROOM SECURITY   |  |   |   |   |         |      |
| GR   | CLASSROOM SECURITY w/HOLDBACK  |  |   |   |   |         |      |
| WW   | INSTITUTIONAL  | F30  |   |   |   |         |      |
| <b>KEYED DOUBLE CYLINDER, WITH DEADBOLT</b>  |  |  |   |   |   |         |      |
| AC   | ENTRANCE   | F35  |   | 895   | 932   | 940     | 977  |
| C  | STOREROOM  | F14  |   |   |   |         |      |
| FC   | INTRUDER DEADBOLT  | F34  |   |   |   |         |      |
| FA   | DORMITORY  | F11  |   |   |   |         |      |
| FX   | DORMITORY  | F33  |   |   |   |         |      |
| <b>KEYLESS</b>   |  |  |   |   |   |         |      |
| N  | PASSAGE  | F01  |   | 738   | 773   | 782     | 818  |
| L  | BATHROOM   | F02  |   | 861   | 898   | 906     | 942  |
| LF   | PRIVACY  | F19  |   |   |   |         |      |
| LJ   | PRIVACY  | F22  |   | 794   | 832   | 840     | 878  |
| EX   | EXIT   | F31  |   |   |   |         |      |
| <b>DUMMY TRIM</b>  |  |  |   |   |   |         |      |
| DI   | DUMMY TRIM INSIDE  |  |   | 371   | 406   | 394     | 431  |
| DO   | DUMMY TRIM OUTSIDE   |  |   |   |   |         |      |
| DT   | FULLY DUMMY  |  |   | 743   | 779   | 789     | 826  |
| <b>KNOBS &amp; LEVERS ARE PACKED 6 PER CASE</b>  |  |  |   |   |   |         |      |
| NOTE: Split designs and/or finishes are priced at the highest design and/or finish • Special finishes, consult factory |  |  |   |   |   |         |      |

# TOWNE PLATE DESIGN TN

|   |  |                      |  |           |   |           |
|---|--|----------------------|--|-----------|---|-----------|
|    | <b>ANSI-A156.13 • Grade 2</b>  |                      | <b>Series 7 • 2-3/4" Backset</b><br><b>Series 9 • 2-1/2" Backset</b> |           |   |           |
|   | <b>Standard Features</b>   |                      | <b>KNOB</b>  |           | <b>LEVER</b>  |           |
|   | <ul style="list-style-type: none"> <li>• Thru-bolted screwless knob/lever plate assemblies</li> <li>• Independent spring loaded captivated spindles</li> <li>• Reversible mortise lock 2-1/2" or 2-3/4" backset</li> <li>• Lever support springs</li> <li>• Lock front Series 7: 1-1/4" x 8"; Series 9: 1-1/16" x 7-5/8"</li> <li>• Dimensions: Ext: 9-1/4" H x 2-1/4" W, Int: 9-1/4" H x 2-1/4" W</li> <li>• Cylinder: MARKS "C" keyway, 6 pin w/ 2 keys</li> </ul> |                      | 30, 60   |           | 031, 44, 55, 57,<br>72, 77, 78, 82,<br>83, 86, 92, 96 |           |
|   |  | <b>FINISH GROUPS</b> |  |           |   |           |
| <b>MARKS #</b>  | <b>FUNCTION</b>  | <b>ANSI #</b>        | <b>3E &amp; 15</b>   | <b>26</b> | <b>3E &amp; 15</b>                                    | <b>26</b> |
| <b>KEYED SINGLE CYLINDER, NO DEADBOLT</b>   |  |                      |  |           |   |           |
| D   | OFFICE VEST.   |                      | 770  | 803       | 813   | 847       |
| DW  | VESTIBULE  |                      |  |           |   |           |
| <b>KEYED SINGLE CYLINDER, WITH DEADBOLT</b>   |  |                      |  |           |   |           |
| A   | ENTRANCE   | F08, F10             | 784  | 819       | 827   | 863       |
| B   | ENTRANCE   | F21                  |  |           |   |           |
| F   | DORMITORY  | F12                  |  |           |   |           |
| FS  | DORMITORY  |                      |  |           |   |           |
| FW  | DORMITORY  | F13                  |  |           |   |           |
| <b>KEYED DOUBLE CYLINDER, WITH DEADBOLT</b>   |  |                      |  |           |   |           |
| AC  | ENTRANCE   | F35                  | 817  | 851       | 861   | 895       |
| C   | STOREROOM  | F14                  |  |           |   |           |
| FX  | DORMITORY  | F33                  |  |           |   |           |
| <b>KEYLESS</b>  |  |                      |  |           |   |           |
| N   | PASSAGE  | F01                  | 667  | 707       | 709   | 744       |
| L   | BATHROOM   | F02                  | 784  | 819       | 827   | 863       |
| LF  | PRIVACY  | F19                  |  |           |   |           |
| <b>DUMMY TRIM</b>   |  |                      |  |           |   |           |
| DI  | DUMMY TRIM INSIDE  |                      | 371  | 406       | 394   | 431       |
| DO  | DUMMY TRIM OUTSIDE   |                      |  |           |   |           |
| DT  | FULLY DUMMY  |                      | 743  | 779       | 789   | 826       |
| <b>KNOB &amp; LEVER ARE PACKED 6 PER CASE</b>   |  |                      |  |           |   |           |
| <b>NOTE: Split designs and/or finishes are priced at the highest design and/or finish • Special finishes, consult factory</b> |  |                      |  |           |   |           |

|              |   |   |  |   |
|--------------|---|---|--|---|
| <b>KNOB</b>  | Ball Knob 30  | Eclipse Knob 60   |  |   |
|              |  |  |  |   |
| <b>LEVER</b> | Stanhope Lever 44   | Copa Lever 031  | Brompton Lever 55  | Monaco Lever 57<br>Specify handing  |
|              |  |  |  |  |
|              | Towne Lever 72  | Maxwell Lever 77  | Omni Lever 78  | Plaza Lever 82<br>Specify handing   |
|              |  |  |  |  |
|              | Dayton Lever 83<br>Specify handing  | Crescent Lever 86   | American Lever 92  | Titan Lever 96  |
|              |  |  |   |  |

# ROSE DESIGN RR, RW, RQ, RS, RX\*, RK\*, RL\*

| <b>BHMA</b><br>CERTIFIED                                       |                               | ANSI-A156.13 • Grade 1<br>3 Hour Fire Rating   | UL<br>LISTED |               | Series 5 • 2-3/4" Backset<br>Series 55 • 2-1/2" Backset |        |   |                  |        |                       |         |
|--|-------------------------------|--|--------------|---------------|---|--------|---|------------------|--------|-----------------------|---------|
| 2-9/16" Diameter<br>RR RW RX<br>2-1/4" Diameter<br>RQ RS RK RL |                               | <b>Standard Features</b>   |              | <b>KNOBS</b>  |   |        | <b>LEVERS</b>   |                  |        |                       |         |
|  |                               | <ul style="list-style-type: none"> <li>• Thru-bolted screwless knob/lever rose assemblies</li> <li>• Independent spring loaded captivated spindles</li> <li>• Reversible mortise lock 2-1/2" or 2-3/4" backset</li> <li>• Lever support springs</li> <li>• Lock front: 1-1/4" x 8"</li> <li>• Cylinder: MARKS "C" keyway, 6 pin w/ 2 keys</li> </ul> |              | 10, 20        | 30, 60  |        | 031, 44, 55, 57,<br>72, 77, 78, 82,<br>83, 86, 92, 96 |                  |        | 82, 83, 86,<br>92, 96 |         |
| <b>MARKS #</b>   |                               | <b>FUNCTION</b>  |              | <b>ANSI #</b> | <b>FINISH GROUPS</b>                                    |        |   |                  |        |                       |         |
|  |                               |  |              |               | 3, 32D  | 3E, 15 | 26, 10B   | 3, 4, 15,<br>26D | 14, 26 | 10E, 10B,<br>19E      | 32, 32D |
| <b>KEYED SINGLE CYLINDER, NO DEADBOLT</b>                      |                               |  |              |               |   |        |   |                  |        |                       |         |
| D  | OFFICE VEST.                  |  |              |               |   |        |   |                  |        |                       |         |
| DW   | VESTIBULE                     |  |              |               |   |        |   |                  |        |                       |         |
| E  | OFFICE                        | F04  |              |               |   |        |   |                  |        |                       |         |
| EW   | STOREROOM                     | F07  |              | 560           | 618   | 655    | 596   | 633              | 670    | 596                   |         |
| J  | CLASSROOM                     | F05  |              |               |   |        |   |                  |        |                       |         |
| JM, JR   | HOSPITAL                      | F06  |              |               |   |        |   |                  |        |                       |         |
| GL   | INSTIT. PRIVACY               | F26  |              |               |   |        |   |                  |        |                       |         |
| EL   | ELECTRICALLY LOCKED           |  |              | 876           | 934   | 971    | 912   | 949              | 975    | 912                   |         |
| EU   | ELECTRICALLY UNLOCKED         |  |              |               |   |        |   |                  |        |                       |         |
| <b>KEYED SINGLE CYLINDER, WITH DEADBOLT</b>                    |                               |  |              |               |   |        |   |                  |        |                       |         |
| A  | ENTRANCE                      | F08, F10   |              |               |   |        |   |                  |        |                       |         |
| B  | ENTRANCE                      | F21  |              |               |   |        |   |                  |        |                       |         |
| F  | DORMITORY                     | F12  |              | 573           | 632   | 669    | 610   | 647              | 673    | 610                   |         |
| FS   | DORMITORY                     |  |              |               |   |        |   |                  |        |                       |         |
| FW   | DORMITORY                     | F13  |              |               |   |        |   |                  |        |                       |         |
| FD   | APARTMENT                     | F20  |              |               |   |        |   |                  |        |                       |         |
| H  | HOTEL                         | F15  |              | 595           | 653   | 690    | 631   | 668              | 694    | 631                   |         |
| LH   | SPECIAL PRIVACY               |  |              |               |   |        |   |                  |        |                       |         |
| <b>KEYED DOUBLE CYLINDER, NO DEADBOLT</b>                      |                               |  |              |               |   |        |   |                  |        |                       |         |
| G  | APARTMENT                     | F09  |              |               |   |        |   |                  |        |                       |         |
| GC   | INTRUDER LATCHBOLT            | F32  |              |               |   |        |   |                  |        |                       |         |
| GG   | CLASSROOM SECURITY            |  |              | 603           | 661   | 699    | 639   | 676              | 703    | 639                   |         |
| GR   | CLASSROOM SECURITY w/HOLDBACK |  |              |               |   |        |   |                  |        |                       |         |
| WW   | INSTITUTIONAL                 | F30  |              |               |   |        |   |                  |        |                       |         |
| <b>KEYED DOUBLE CYLINDER, WITH DEADBOLT</b>                    |                               |  |              |               |   |        |   |                  |        |                       |         |
| AC   | ENTRANCE                      | F35  |              |               |   |        |   |                  |        |                       |         |
| C  | STOREROOM                     | F14  |              |               |   |        |   |                  |        |                       |         |
| FC   | INTRUDER DEADBOLT             | F34  |              | 603           | 661   | 699    | 639   | 676              | 703    | 639                   |         |
| FA   | DORMITORY                     | F11  |              |               |   |        |   |                  |        |                       |         |
| FX   | DORMITORY                     | F33  |              |               |   |        |   |                  |        |                       |         |
| <b>KEYLESS</b>   |                               |  |              |               |   |        |   |                  |        |                       |         |
| N  | PASSAGE                       | F01  |              | 435           | 554   | 591    | 547   | 591              | 584    | 547                   |         |
| L  | BATHROOM                      | F02  |              |               |   |        |   |                  |        |                       |         |
| LF   | PRIVACY                       | F19  |              | 573           | 632   | 669    | 610   | 647              | 673    | 610                   |         |
| LJ   | PRIVACY                       | F22  |              |               |   |        |   |                  |        |                       |         |
| EX   | EXIT                          | F31  |              | 516           | 575   | 612    | 552   | 589              | 616    | 552                   |         |
| <b>DUMMY TRIM</b>  |                               |  |              |               |   |        |   |                  |        |                       |         |
| DI   | DUMMY TRIM INSIDE             |  |              | 117           | 145   | 164    | 135   | 153              | 166    | 135                   |         |
| DO   | DUMMY TRIM OUTSIDE            |  |              |               |   |        |   |                  |        |                       |         |
| DT   | FULLY DUMMY                   |  |              | 232           | 290   | 328    | 268   | 305              | 332    | 268                   |         |

**KNOBS & LEVERS ARE PACKED 6 PER CASE**

NOTE: Split designs and/or finishes are priced at the highest design and/or finish • Special finishes, consult factory

F17 Dummy Cylinder: Add \$44.00



\*Square Rose RX: Add \$30 / \*Square Rose RK: Add \$100

# ROSE DESIGN RR, RW, RQ, RS, RX\*, RK\*, RL\*

| Diameter<br>RR RW RX<br><br>Diameter<br>RQ RS RK  |                    | ANSI-A156.13 • Grade 2 | Series 7 • 2-3/4" Backset<br>Series 9 • 2-1/2" Backset |        |   |         |                          |        |                  |         |
|---|--------------------|------------------------|--|--------|---|---------|--------------------------|--------|------------------|---------|
| Standard Features   |                    | KNOBS                  |  |        | LEVERS  |         |                          |        |                  |         |
| <ul style="list-style-type: none"> <li>• Thru-bolted screwless knob/lever rose assemblies</li> <li>• Independent spring loaded captivated spindles</li> <li>• Reversible mortise lock 2-1/2" or 2-3/4" backset</li> <li>• Lever support springs • Lock front: 1-1/4" x 8"</li> <li>• Cylinder: MARKS "C" keyway, 6 pin w/ 2 keys</li> </ul> |                    | 10, 20                 | 30, 60   |        | 031, 44, 55, 57,<br>72, 77, 78, 82,<br>83, 86, 92, 96 |         | 82, 83,<br>86,<br>92, 96 |        |                  |         |
| MARKS #   |                    | FUNCTION               | ANSI #   | 3, 32D | 3E, 15  | 26, 10B | 3, 4, 15,<br>26D         | 14, 26 | 10E, 10B,<br>19E | 32, 32D |
| KEYED SINGLE CYLINDER, NO DEADBOLT  |                    |                        |  |        |   |         |                          |        |                  |         |
| D   | OFFICE VEST.       |                        | 528  | 586    | 615   | 564     | 601                      | 628    | 564              |         |
| DW  | VESTIBULE          |                        |  |        |   |         |                          |        |                  |         |
| KEYED SINGLE CYLINDER, WITH DEADBOLT  |                    |                        |  |        |   |         |                          |        |                  |         |
| A   | ENTRANCE           | F08, F10               | 542  | 600    | 637   | 578     | 615                      | 641    | 578              |         |
| B   | ENTRANCE           | F21                    |  |        |   |         |                          |        |                  |         |
| F   | DORMITORY          | F12                    |  |        |   |         |                          |        |                  |         |
| FS  | DORMITORY          |                        |  |        |   |         |                          |        |                  |         |
| FW  | DORMITORY          | F13                    |  |        |   |         |                          |        |                  |         |
| KEYED DOUBLE CYLINDER, WITH DEADBOLT  |                    |                        |  |        |   |         |                          |        |                  |         |
| AC  | ENTRANCE           | F35                    | 571  | 630    | 667   | 607     | 644                      | 671    | 607              |         |
| C   | STOREROOM          | F14                    |  |        |   |         |                          |        |                  |         |
| FX  | DORMITORY          | F33                    |  |        |   |         |                          |        |                  |         |
| KEYLESS   |                    |                        |  |        |   |         |                          |        |                  |         |
| N   | PASSAGE            | F01                    | 435  | 493    | 530   | 471     | 508                      | 534    | 471              |         |
| L   | BATHROOM           | F02                    | 542  | 600    | 637   | 578     | 721                      | 641    | 578              |         |
| LF  | PRIVACY            | F19                    |  |        |   |         |                          |        |                  |         |
| DUMMY TRIM  |                    |                        |  |        |   |         |                          |        |                  |         |
| DI  | DUMMY TRIM INSIDE  |                        | 117  | 145    | 164   | 135     | 153                      | 166    | 135              |         |
| DO  | DUMMY TRIM OUTSIDE |                        |  |        |   |         |                          |        |                  |         |
| DT  | FULLY DUMMY        |                        | 232  | 240    | 328   | 268     | 305                      | 332    | 268              |         |
| <b>KNOBES &amp; LEVERS ARE PACKED 6 PER CASE</b><br>NOTE: Split designs and/or finishes are priced at the highest design and/or finish • Special finishes, consult factory<br>*Square Rose RX: Add \$30 / *Square Rose RK: Add \$100  |                    |                        |  |        |   |         |                          |        |                  |         |

| KNOBS  | Round Knob 10                      | Ball Knob 20      | Ball Knob 30      | Eclipse Knob 60                    | ROSES          | RR: 2-9/16" dia. |
|--------|------------------------------------|-------------------|-------------------|------------------------------------|----------------|------------------|
|        |                                    |                   |                   |                                    |                |                  |
| LEVERS | Stanhope Lever 44                  | Copa Lever 031    | Brompton Lever 55 | Monaco Lever 57<br>Specify handing |                | RQ: 2-1/4" dia.  |
|        |                                    |                   |                   |                                    |                | RS: 2-1/4" dia.  |
|        | Towne Lever 72                     | Maxwell Lever 77  | Omni Lever 78     | Plaza Lever 82<br>Specify handing  |                |                  |
|        |                                    |                   |                   |                                    |                |                  |
|        | Dayton Lever 83<br>Specify handing | Crescent Lever 86 | American Lever 92 | Titan Lever 96                     |                |                  |
|        |                                    |                   |                   |                                    |                |                  |
|        |                                    |                   |                   |                                    | RX: 2-1/2" sq. | RK: 2-1/2" sq.   |
|        |                                    |                   |                   |                                    |                | RL: 2-1/2" sq.   |



# CROWN HANDLESET DESIGN CR

|   |  |  |                                 |   |                                 |   |
|---|--|--|---------------------------------|---|---------------------------------|---|
|    |   | ANSI-A156.13 • Grade 1<br>3 Hour Fire Rating |                                 | Series 4 • 2-3/4" Backset   | Series 6 • 2-3/4" Backset       |   |
|   |  |  |                                 | Series 45 • 2-1/2" Backset  | Series 8 • 2-1/2" Backset       |   |
|    | <b>Standard Features</b> <ul style="list-style-type: none"> <li>• Exterior handle plate assemblies with thru-posts</li> <li>• Interior thru-bolted screwless knob/lever plate assemblies</li> <li>• Independent spring loaded captivated spindles</li> <li>• Reversible mortise lock 2-1/2" or 2-3/4" backset</li> <li>• Lever support springs • Lock front Series 4, 45: 1-1/4" x 8"</li> <li>• Lock front Series 6: 1-1/4" x 8"; Series 8: 1-1/16" x 7-5/8"</li> <li>• Dimensions: CROWN Ext: 16" H x 2" W, Int: 8-1/2" H x 2" W</li> <li>• Dimensions: GRAND CROWN Ext: 16" H x 2" W, Int: 8-1/2" H x 2" W</li> <li>• Cylinder: MARKS "C" keyway, 6 pin w/ 2 keys</li> <li>• Thickness: 13/32"</li> </ul> |  | <b>KNOB</b><br><br>30, 60       | <b>LEVERS</b><br><br>031, 44, 55,<br>57, 72, 77,<br>78, 82, 83,<br>86, 92, 96 | <b>KNOB</b><br><br>30, 60       | <b>LEVERS</b><br><br>031, 44, 55,<br>57, 72, 77,<br>78, 82, 83,<br>86, 92, 96 |
|   |  |  | <b>FINISH GROUPS</b><br>3E & 15 |   | <b>FINISH GROUPS</b><br>3E & 15 |   |
| <b>GRADE 1 HANDLESETS</b>   | <b>MARKS #</b>   | <b>FUNCTION</b>                              | <b>ANSI #</b>                   | <b>3E &amp; 15</b>  |                                 |   |
|   | <b>KEYED SINGLE CYLINDER, NO DEADBOLT</b>  |  |                                 |   |                                 |   |
|   | D  | OFFICE VEST.                                 |                                 | 1185  |                                 | 1126  |
|   | DW   | VESTIBULE                                    |                                 | 1185  |                                 |   |
|   | EW   | STOREROOM                                    | F07                             | 1185  |                                 |   |
|   | <b>KEYED SINGLE CYLINDER, WITH DEADBOLT</b>  |  |                                 |   |                                 |   |
|   | A  | ENTRANCE                                     | F08, F10                        | 1199  |                                 | 1141  |
|   | B  | ENTRANCE                                     | F21                             | 1199  |                                 |   |
|   | F  | DORMITORY                                    | F12                             | 1199  |                                 |   |
|   | <b>KEYED DOUBLE CYLINDER, WITH DEADBOLT</b>  |  |                                 |   |                                 |   |
| AC  | ENTRANCE   | F35  | 1232                            |   | 1173                            |   |
| C   | STOREROOM  | F25  | 1232                            |   |                                 |   |
| G   | APARTMENT  | F24  | 1232                            |   |                                 |   |
| SO  | STOREROOM: DOUBLE HANDLESET ONLY   | F25  | 1526                            |   | 1467                            |   |
| <b>DUMMY TRIM</b>   |  |  |                                 |   |                                 |   |
| DT  | FULLY DUMMY  |  | 966                             |   | 966                             |   |
| <b>HANDLESETS ARE PACKED 6 PER CASE</b><br>NOTE: Split designs and/or finishes are priced at the highest design and/or finish • Special finishes, consult factory<br>SO Function Double Handleset ONLY * SERIES 45 NOT AVAILABLE IN "SO" FUNCTION |  |  |                                 |   |                                 |   |

|             |   |   |   |
|-------------|---|---|---|
| <b>KNOB</b> | Ball Knob 30  | Eclipse Knob 60   | 9691  |
|             |  |  |  |

|   |   |  |   |   |
|---|---|--|---|---|
| <b>LEVERS</b>   | Stanhope Lever 44   | Copa Lever 031   | Brompton Lever 55   | Monaco Lever 57<br>Specify handing  |
|   |  |   |   |  |
|   | Towne Lever 72  | Maxwell Lever 77   | Omni Lever 78   | Plaza Lever 82<br>Specify handing   |
|   |  |   |   |  |
| Dayton Lever 83<br>Specify handing  | Crescent Lever 86   | American Lever 92  | Titan Lever 96  |   |
|  |  |  |  |   |

# TOWNE HANDLESET DESIGN TN

|   |   |  |               |   |  |              |  |
|---|---|--|---------------|---|--|--------------|--|
|   |  | <b>ANSI-A156.13 • Grade 1<br/>3 Hour Fire Rating</b>   |               | <b>Series 4 • 2-3/4" Backset</b><br><b>Series 45 • 2-1/2" Backset</b> | <b>Series 6 • 2-3/4" Backset</b><br><b>Series 8 • 2-1/2" Backset</b> |              |  |
|   |   | <b>Standard Features</b>   |               | <b>KNOBS</b>  | <b>LEVERS</b>  | <b>KNOBS</b> | <b>LEVERS</b>  |
|   |   | <ul style="list-style-type: none"> <li>• Exterior handle plate assemblies with thru-posts</li> <li>• Interior thru-bolted screwless knob/lever plate assemblies</li> <li>• Independent spring loaded captivated spindles</li> <li>• Reversible mortise lock 2-1/2" or 2-3/4" backset</li> <li>• Lever support springs • Lock front Series 4, 45: 1-1/4" x 8"</li> <li>• Lock front Series 6: 1-1/4" x 8"; Series 8: 1-1/16" x 7-5/8"</li> <li>• Dimensions:<br/>TOWNE Ext: 16-3/8" H x 2-1/4" W, Int: 9-1/4" H x 2-1/4" W</li> <li>• Dimensions:<br/>GRAND TOWNE Ext: 16-3/4" H x 2-1/4" W, Int: 9-1/4" H x 2-1/4" W</li> <li>• Dimensions:<br/>CLAREMONT Ext: 16-1/4" H x 2-1/4" W, Int: 9-1/4" H x 2-1/4" W</li> <li>• Cylinder: MARKS "C" keyway, 6 pin w/ 2 keys</li> <li>• Thickness: 13/32"</li> </ul> |               | 30, 60  | 031, 44, 55,<br>57, 72, 77,<br>78, 82, 83,<br>86, 92, 96             | 30, 60       | 031, 44, 55,<br>57, 72, 77,<br>78, 82, 83,<br>86, 92, 96 |
|   |   | <b>FINISH GROUPS</b>   |               | <b>FINISH GROUPS</b>  |  |              |  |
| <b>GRADE 1 HANDLESETS</b>   | <b>MARKS #</b>  | <b>FUNCTION</b>  | <b>ANSI #</b> | <b>3E &amp; 15</b>  |  |              |  |
|   | <b>KEYED SINGLE CYLINDER, NO DEADBOLT</b>   |  |               |   |  |              |  |
|   | D   | OFFICE VEST.   |               | 1185  |  | 1126         |  |
|   | DW  | VESTIBULE  |               | 1185  |  |              |  |
|   | EW  | STOREROOM  | F07           | 1185  |  |              |  |
|   | <b>KEYED SINGLE CYLINDER, WITH DEADBOLT</b>                                       |  |               |   |  |              |  |
|   | A   | ENTRANCE   | F08, F10      | 1199  |  | 1141         |  |
|   | B   | ENTRANCE   | F21           | 1199  |  |              |  |
|   | F   | DORMITORY  | F12           | 1199  |  |              |  |
|   | <b>KEYED DOUBLE CYLINDER, WITH DEADBOLT</b>                                       |  |               |   |  |              |  |
|   | AC  | ENTRANCE   | F35           | 1232  |  | 1173         |  |
|   | C   | STOREROOM  | F25           | 1232  |  |              |  |
| G   | APARTMENT   | F24  | 1232          |   |  |              |  |
| SO  | STOREROOM: DOUBLE HANDLESET ONLY  | F25  | 1526          |   | 1467   |              |  |
| <b>DUMMY TRIM</b>   |   |  |               |   |  |              |  |
| DT  | FULLY DUMMY   |  | 966           |   | 966  |              |  |

**GRADE 2 HANDLESETS**

**HANDLESETS ARE PACKED 6 PER CASE**

NOTE: Split designs and/or finishes are priced at the highest design and/or finish • Special finishes, consult factory

SO Function Double Handleset ONLY \* SERIES 45 NOT AVAILABLE IN "SO" FUNCTION

|              |   |   |   |
|--------------|---|---|---|
| <b>KNOBS</b> | Ball Knob 30  | Eclipse Knob 60   | 9691  |
|              |  |  |  |

|               |   |   |  |   |
|---------------|---|---|--|---|
| <b>LEVERS</b> | Stanhope Lever 44   | Copa Lever 031  | Brompton Lever 55  | Monaco Lever 57<br>Specify handing  |
|               |  |  |  |  |
|               | Towne Lever 72  | Maxwell Lever 77  | Omni Lever 78  | Plaza Lever 82<br>Specify handing   |
|               |  |  |  |  |
|               | Dayton Lever 83<br>Specify handing  | Crescent Lever 86   | American Lever 92  | Titan Lever 96  |
|               |  |  |  |  |



# ORNAMENTAL IRON

Ornamental Iron

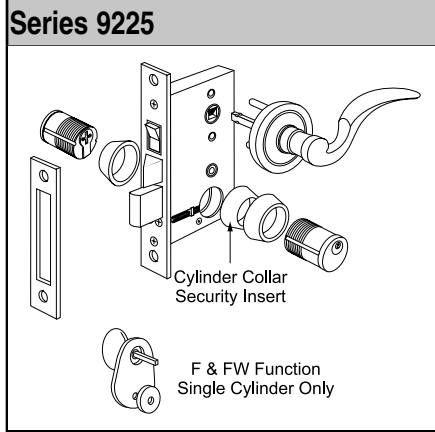
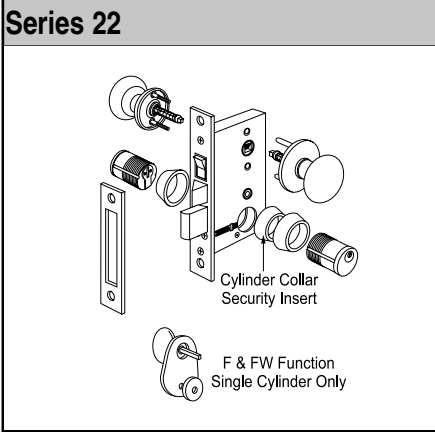
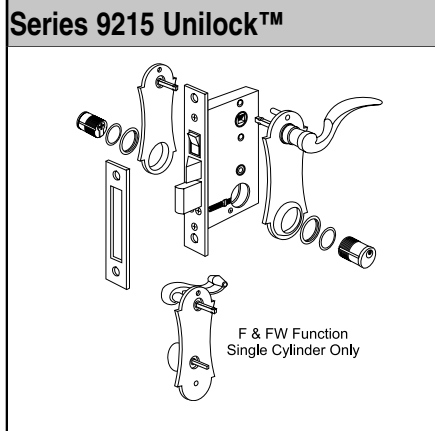
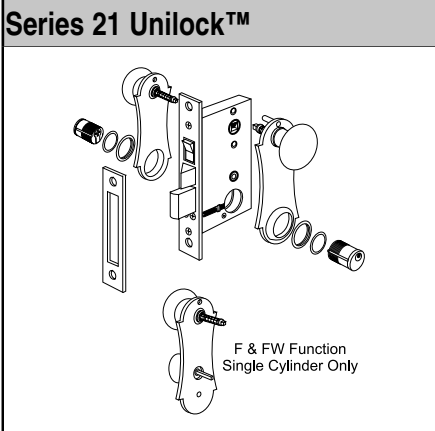

| Standard Features  |                               | SERIES                   |              |               |
|--|-------------------------------|--------------------------|--------------|---------------|
| <ul style="list-style-type: none"> <li>• Thru-bolted solid brass trim assemblies</li> <li>• Spring loaded captivated spindles</li> <li>• Reversible mortise lock 1" backset</li> <li>• 1" bolt, 1/2" latch projection</li> <li>• Cylinder: Marks "A" keyway, 5 pin w/ 2 keys; keyed alike - 6</li> </ul> |                               | <b>2750</b><br>THINLINE® |              |               |
|  |                               | FINISH GROUPS            |              |               |
| <b>MARKS #</b>   | <b>FUNCTION</b>               | <b>3</b>                 | <b>10B</b>   | <b>5, 26D</b> |
| <b>KEYED WITH DEADBOLT</b>   |                               |                          |              |               |
| B  | ENTRANCE CYLINDER x TURNPIECE | 207                      | 261          | 233           |
| C  | ENTRANCE DOUBLE CYLINDER      |                          |              |               |
| <b>DUMMY TRIM</b>  |                               |                          |              |               |
| DT   | FULL DUMMY                    | 125                      | 174          | 145           |
| <b>ORNAMENTAL IRON LOCKSETS PACKED 6 PER CASE</b>  |                               |                          |              |               |
| <b>OPTIONS - Series 2750</b>   |                               | <b>CODE</b>              | <b>PRICE</b> |               |
| For 1-3/4" doors   |                               | D4                       | NC           |               |
| Marks "C" keyway   |                               | G5                       | 16           |               |

| Standard Features  |                         | SERIES 21<br>UNILOCK™<br>SERIES 22 |            |               | SERIES 9215<br>UNILOCK™<br>SERIES 9225 |            |               |
|--|-------------------------|------------------------------------|------------|---------------|--|------------|---------------|
| <ul style="list-style-type: none"> <li>• Door thickness: 1"</li> <li>• Series 9 lock body, Backset: 2-1/2"</li> <li>• Reversible mortise lock 1" bolt, 1/2" latch projection</li> <li>• Lock front: 1" x 7-1/8"</li> <li>• Thru-bolted solid brass trim assemblies</li> <li>• Spring loaded captivated spindles</li> <li>• Cylinder: Marks "A" keyway, 5 pin w/ 2 keys; keyed alike-6</li> </ul> |                         |                                    |            |               |  |            |               |
|  |                         | FINISH GROUPS                      |            |               |  |            |               |
| <b>MARKS #</b>   | <b>FUNCTION</b>         | <b>3</b>                           | <b>10B</b> | <b>5, 26D</b> | <b>3</b>                               | <b>10B</b> | <b>5, 26D</b> |
| <b>KEYED SINGLE CYLINDER, WITH DEADBOLT</b>  |                         |                                    |            |               |  |            |               |
| DW   | SINGLE CYL. PANIC PROOF |                                    |            |               |  |            |               |
| F  | SINGLE CYL. PANIC PROOF | 278                                | 332        | 296           | 371                                    | 419        | 390           |
| FW   | SINGLE CYL. PANIC PROOF |                                    |            |               |  |            |               |
| <b>KEYED DOUBLE CYLINDER, WITH DEADBOLT</b>  |                         |                                    |            |               |  |            |               |
| AC   | ENTRANCE                | 247                                | 304        | 265           | 341                                    | 390        | 359           |
| <b>DUMMY TRIM</b>  |                         |                                    |            |               |  |            |               |
| DT   | FULL DUMMY              | 165                                | 228        | 177           | 265                                    | 321        | 278           |
| <b>ORNAMENTAL IRON LOCKSETS ARE PACKED 6 PER CASE</b>  |                         |                                    |            |               |  |            |               |

| OPTIONS                             | CODE | PRICE |
|-------------------------------------|------|-------|
| Lock Front: 1" x 7-1/8" standard    | W    | NC    |
| Mushroom knob interior; 1-7/8" prj. | A9   | 5     |
| For 1-3/4" doors                    | D4   | NC    |
| Adjustable spring collars           | F10  | 5     |

| How To Order Example for Ornamental Iron Locksets         |  |          |   |                                  |            |
|---|--|----------|---|----------------------------------|------------|
| <b>9215</b>   | <b>C</b>   | <b>/</b> | <b>10B</b>  | <b>-</b>                         | <b>D4</b>  |
| 1. Lock Series  | 2. Marks Function                                      | Slash    | 3. Finish   | Dash                             | 4. Options |
| <b>LOCK SERIES</b><br>(Pgs. 49 & 50)                      | <b>MARKS FUNCTION</b><br>(Pgs. 57-58)                  |          | <b>FINISH (Pg. 10)</b>                                  | <b>OPTIONS</b>                   |            |
| <input type="checkbox"/> 21 <input type="checkbox"/> 2750 | <input type="checkbox"/> B <input type="checkbox"/> AC |          | <input type="checkbox"/> 3 <input type="checkbox"/> 10B | <input type="checkbox"/> Special |            |
| <input type="checkbox"/> 22 <input type="checkbox"/> 9215 | <input type="checkbox"/> C <input type="checkbox"/> DT |          | <input type="checkbox"/> 5 <input type="checkbox"/> 26D | Specify                          |            |
|   | <input type="checkbox"/> F <input type="checkbox"/> DW |          |   | • Keying • Handing               |            |
|   |  |          |   | • Door Thickness                 |            |



# ORNAMENTAL IRON

## Knob & Lever Kits

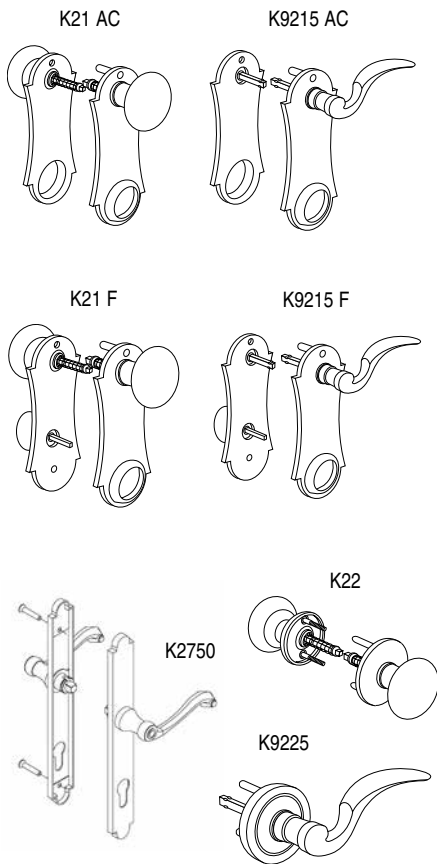

| PART #  | DESCRIPTION   | FUNCTION | FINISH GROUPS |     |     |        |
|---------|---|----------|---------------|-----|-----|--------|
|         |   |          | 3             | 4   | 10B | 5, 26D |
| K21AC   | Ext./Int. UNILOCK™ knob/plate kit   | AC       | 122           | —   | 159 | 135    |
| K21AC-M | Ext./Int. UNILOCK™ knob/plate kit (Mushroom Int.)                                       | AC       | 137           | —   | 164 | 141    |
| K21F    | Ext./Int. UNILOCK™ knob/plate kit assemblies  | F        | 146           | —   | 176 | 153    |
| K21F-M  | Ext./Int. UNILOCK™ knob/plate kit (Mushroom Int.)                                       | F        | 151           | —   | 182 | 159    |
| K2750   | LEVER PLATE TRIM SET  |          | 146           | —   | 189 | 166    |
| 2600B   | Thinline lock body, latch, deadbolt<br><b>US 4 &amp; 26D ONLY - Strike not included</b> |          | —             | 121 | 189 | 166    |
| K9215AC | Ext./Int. UNILOCK™ lever/plate kit assemblies   | AC       | 184           | —   | 218 | 195    |
| K9215F  | Ext./Int. UNILOCK™ lever/plate kit assemblies   | F        | 184           | —   | 239 | 216    |
| A9214-M | UNILOCK™ mushroom knob/plate (w/cylinder hole)  | AC       | 68            | —   | 95  | 71     |
| K9217-M | UNILOCK™ mushroom knob/plate (w/turnpiece)  | F        | 119           | —   | 145 | 122    |
| K22     | Ext./Int. knob/rose kit 1" thru 1-3/4" door   |          | 71            | —   | 109 | 86     |
| K22-M   | Ext./Int. knob/rose kit (mushroom int.)   |          | 78            | —   | 114 | 91     |
| K9225   | Ext./Int. lever/rose kit  |          | 180           | —   | 212 | 189    |

Ornamental Iron

## Accessories

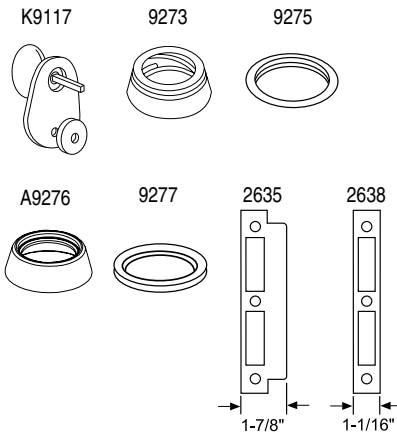

| PART #  | DESCRIPTION                                 | FINISH GROUPS |    |        |
|---------|---|---------------|----|--------|
|         |   | NO FINISH     | 3  | 5, 26D |
| K9117   | Turnpiece kit                               | —             | 47 | 50     |
| A9223-M | Interior knob/rose assembly (mushroom knob) | —             | 40 | 47     |
| 9273    | Spring collar, 7/16" high                   | —             | 12 | 12     |
| 9275    | Mortise spacer, wrought brass, 1/8" high    | —             | 6  | —      |
| A9276   | Collar, wrought brass w/insert, 1/2" high   | —             | 20 | 20     |
| 9277    | Plastic spacer ring, 1/16"                  | 1             | —  | —      |
| 2635    | Curved lip strike, solid brass              | —             | 24 | 15     |
| 2638    | Flat strike, solid brass, no lip            | —             | 15 | 7      |

## Cylinders

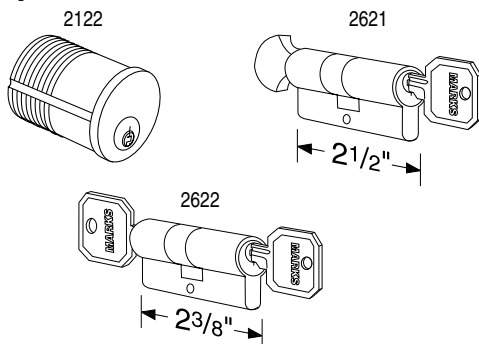

| PART # | DESCRIPTION                                | FINISH GROUPS |        |
|--------|--|---------------|--------|
|        |  | 3             | 5, 26D |
| 2122-A | 5 Pin mortise cylinder, "A" keyway, 15/16" | 41            | 43     |
| 2621-A | Cylinder x turnpiece unit, "A" keyway      | 67            | 74     |
| 2622-A | double cylinder unit, "A" keyway           | 48            | 60     |
| 2122-C | 5 Pin mortise cylinder, "C" keyway         | 41            | 43     |
| 2621-C | Cylinder x turnpiece unit, "C" keyway      | 67            | 74     |
| 2622-C | double cylinder unit, "C" keyway           | 48            | 60     |

# MORTISE LOCK BODIES

## AUTOREVERSE SERIES

GRADE 1  
MORTISE LOCKS EXCEEDS  
BHMA  
SPECIFICATIONS

Mortise Parts, Trim

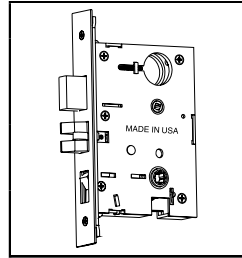
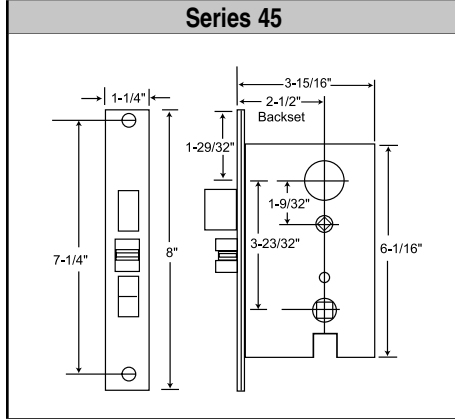
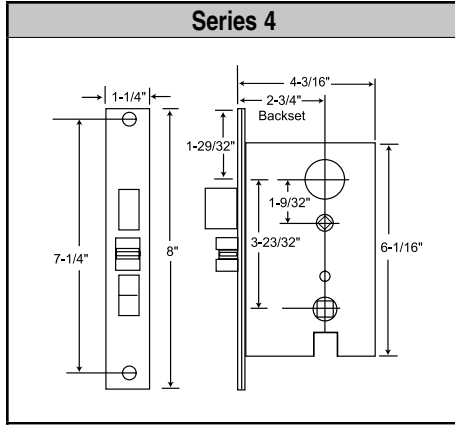

| Standard Features   |          | Grade 1 for Handlesets   |                     |
|---|----------|--|---------------------|
| <ul style="list-style-type: none"> <li>Backset: 4 Series 2-3/4"; 45 Series 2-1/2"</li> <li>Bolt throw: Stainless steel full 1" throw</li> <li>Latch throw: 3/4" (anti-friction)</li> <li>Auxiliary latch: 1/2" throw</li> <li>Case: Stamped steel .090 thick., Zinc dichromate finish</li> <li>Front: 1-1/4" x 8", Adjustable bevel</li> <li>Hubs: Steel, 9/32" on diamond 5/16" on square</li> </ul> |          | Series 4 • 2-3/4" Backset<br>Series 45 • 2-1/2" Backset<br><b>BHMA</b> CERTIFIED<br><b>UL</b> LISTED |                     |
| FINISH GROUPS   |          |  |                     |
| MARKS #   | FUNCTION | ANSI #   |                     |
|   |          |  | 3, 32D, 10, 10B, 32 |

| KEYED SINGLE CYLINDER, NO DEADBOLT   |                     |          |                    |
|--------------------------------------|---------------------|----------|--------------------|
| DW                                   | VESTIBULE           |          |                    |
| EW                                   | STOREROOM           | F07      |                    |
| EN                                   | STOREROOM           |          |                    |
| DN                                   | STOREROOM           |          |                    |
|                                      |                     |          | 367, 383           |
| KEYED SINGLE CYLINDER, WITH DEADBOLT |                     |          |                    |
| A                                    | ENTRANCE            | F08, F10 |                    |
| B                                    | ENTRANCE            | F21      |                    |
| F                                    | DORMITORY           | F12      |                    |
| FD                                   | APARTMENT           | F20      |                    |
|                                      |                     |          | 378, 395, 394, 411 |
| KEYED DOUBLE CYLINDER, NO DEADBOLT   |                     |          |                    |
| G                                    | ENTRANCE            | F09      |                    |
|                                      |                     |          | 394, 411           |
| KEYED DOUBLE CYLINDER, WITH DEADBOLT |                     |          |                    |
| AC                                   | ENTRANCE            | F35      |                    |
| C                                    | STORE DOOR "B BODY" | F25      |                    |
| SO                                   | STORE DOOR*         | F25      |                    |
|                                      |                     |          | 394, 411           |

| OPTIONS                             | CODE | PRICE |
|-------------------------------------|------|-------|
| 1-1/16" x 7-5/8" front              | T    | 27    |
| 1-1/16" x 7-3/4" front              | V    | 27    |
| 1-1/16" x 8" front                  | Q    | 27    |
| Lever support springs w- 5/16" hubs | B4   | 19    |
| Turnpiece hub on square             | B8   | 11    |
| Screws with Dust Box                | B10  | NC    |
| Solid latch for electric strike     | E1   | 20    |
| Hold open latch                     | E2   | 37    |
| Lead-lined mortise lock             | F1   | 325   |
| 4-7/8" Strikes: 1 Left / 1 Right    | S6   | 13    |

**CYLINDER CAMS REQUIRED**

Locks w/o deadbolt      2101 Straight Cam  
 Locks w/ deadbolt      2102 Cloverleaf Cam

See pages 41 & 42 for additional cams per function

**MORTISE LOCK BODIES ARE PACKED 12 PER CASE**  
 \* SERIES 45 NOT AVAILABLE IN "SO" FUNCTION

# MORTISE LOCK BODIES

## AUTOREVERSE SERIES

**GRADE 1  
MORTISE LOCKS EXCEEDS  
BHMA  
SPECIFICATIONS**

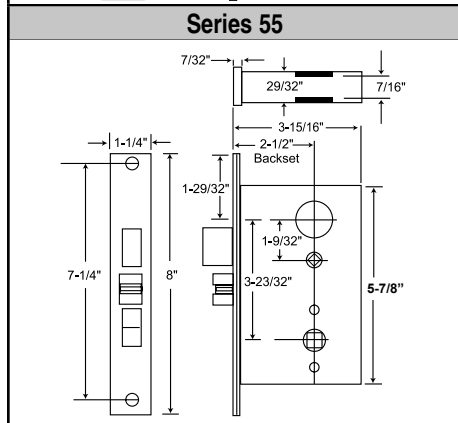
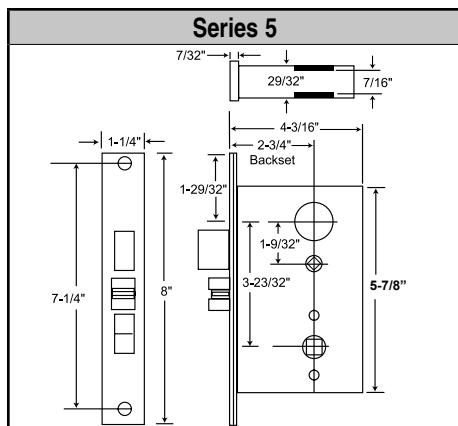

| OPTIONS                                 | CODE | PRICE |
|---|------|-------|
| 1-1/16" x 7-5/8" front                  | T    | 27    |
| 1-1/16" x 7-3/4" front                  | V    | 27    |
| 1-1/16" x 8" front                      | Q    | 27    |
| Lever override guard outside (Series 5) | B1   | 44    |
| Lever override guard both sides         | B2   | 62    |
| Lever support springs w- 5/16" hubs     | B4   | 19    |
| Hubs with hollow spacer (Series 55)     | B6   | 18    |
| Turnpiece hub on square                 | B8   | 11    |
| Screws with Dust Box                    | B10  | NC    |
| Solid latch for electric strike         | E1   | 20    |
| Hold open latch                         | E2   | 37    |
| Lead-lined mortise lock                 | F1   | 325   |
| 4-7/8" Strikes: 1 Left / 1 Right        | S6   | 13    |
| Request to exit switch (Series 5)       | W10  | 136   |

| CYLINDER CAMS REQUIRED |                     |
|------------------------|---------------------|
| Locks w/o deadbolt     | 2101 Straight Cam   |
| Locks w/deadbolt       | 2102 Cloverleaf Cam |
| G function (ext. only) | 2106 "G" Cam        |
| G function (int. only) | 2105 "J" Cam        |
| J function             | 2105 "J" Cam        |

\* 55 Series Lock Bodies are not available in autoreverse and electrified functions EL and EU.

| MARKS #   | FUNCTION                      | ANSI #   | Grade 1 for  |             |
|---|-------------------------------|----------|--|-------------|
|   |                               |          | 3, 32D   | 10, 10B, 32 |
|   |                               |          | <b>Standard Features</b><br>• Backset: 5 Series 2-3/4"; 55 Series 2-1/2"<br>• Bolt throw: Stainless steel full 1" throw<br>• Latch throw: 3/4" (anti-friction)<br>• Auxiliary latch: 1/2" throw<br>• Case: Stamped steel .090 thick., Zinc dichromate finish<br>• Front: 1-1/4" x 8", Adjustable bevel<br>• Hubs: Steel, 9/32" on diamond 5/16" on square w/security separator |             |
|   |                               |          | <b>Knobs &amp; Levers</b><br>Series 5 • 2-3/4" Backset<br>Series 55 • 2-1/2" Backset<br>   |             |
|   |                               |          | <b>FINISH GROUPS</b>   |             |
| <b>KEYED SINGLE CYLINDER, NO DEADBOLT</b>   |                               |          |  |             |
| D   | OFFICE / VESTIBULE            |          | 308  | 403         |
| DW  | VESTIBULE                     |          |  |             |
| E, Q, QH  | OFFICE                        | F04      |  |             |
| K   | OFFICE                        | F04      |  |             |
| EW  | STOREROOM                     | F07      |  |             |
| J   | CLASSROOM                     | F05      |  |             |
| JM, JR  | HOSPITAL (HOLDBACK)           | F06      |  |             |
| GL  | INST. PRIVACY                 | F26      |  |             |
| MT  | ArchITech                     |          | 1113   | 1134        |
| EL*   | ELECTRICALLY LOCKED*          |          | 843  | 861         |
| EU*   | ELECTRICALLY UNLOCKED*        |          |  |             |
| <b>KEYED SINGLE CYLINDER, WITH DEADBOLT</b>   |                               |          |  |             |
| A   | ENTRANCE                      | F08, F10 | 323  | 341         |
| B   | ENTRANCE                      | F21      |  |             |
| F   | DORMITORY                     | F12      |  |             |
| FS  | DORMITORY                     |          |  |             |
| FW  | DORMITORY                     | F13      |  |             |
| FD  | APARTMENT                     | F20      | 347  | 365         |
| AD  |                               | F27      |  |             |
| H   | HOTEL                         | F15      |  |             |
| LH  | SPEC. PRIVACY                 |          |  |             |
| <b>KEYED DOUBLE CYLINDER, NO DEADBOLT</b>   |                               |          |  |             |
| G   | ENTRANCE                      | F09      | 354  | 372         |
| GC  | INTRUDER LATCHBOLT            | F32      |  |             |
| GG  | CLASSROOM SECURITY            |          |  |             |
| GR  | CLASSROOM SECURITY w/HOLDBACK |          |  |             |
| WW  | INSTITUTION                   | F30      |  |             |
| <b>KEYED DOUBLE CYLINDER, WITH DEADBOLT</b>   |                               |          |  |             |
| AC  | ENTRANCE                      | F35      | 354  | 372         |
| C   | STOREROOM                     | F14      |  |             |
| FC  | INTRUDER DEADBOLT             | F34      |  |             |
| FA  | DORMITORY                     | F11      |  |             |
| FX  | DORMITORY                     | F33      |  |             |
| <b>KEYLESS</b>  |                               |          |  |             |
| N   | PASSAGE                       | F01      | 253  | 271         |
| L   | BATHROOM                      | F02      | 323  | 341         |
| LF  | PRIVACY                       | F19      |  |             |
| LJ  | PRIVACY                       | F19      |  |             |
| EX  | EXIT                          | F31      |  |             |
| <b>MORTISE LOCK BODIES ARE PACKED 6 PER CASE</b>  |                               |          |  |             |
| * Electrified Functions 5 SERIES ONLY; 2-3/4" Backset ONLY; 100% Duty Cycle 24V/DC, 12V/DC Optional supplied with bridge rectifier (350 ma) |                               |          |  |             |

Mortise Parts, Trim

# MORTISE LOCK BODIES

Mortise Parts, Trim

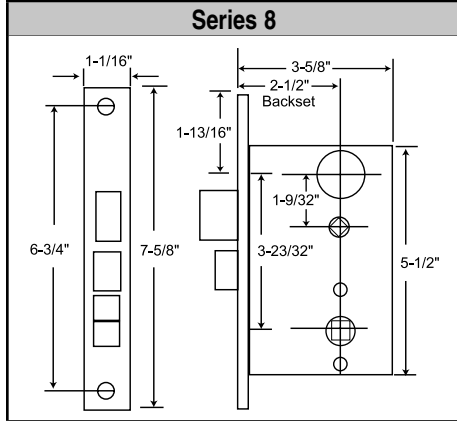
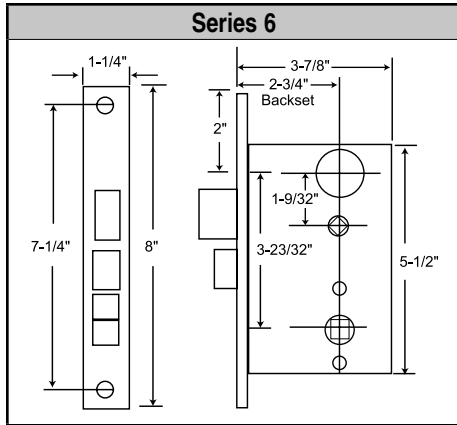

| OPTIONS  | CODE | PRICE |
|--|------|-------|
| 1-1/16" x 7-5/8" front   | T    | 27    |
| 1-1/4" x 10" front,<br>(A function, US 4 only),<br>no mounting holes | U    | 109   |
| 1" x 7-1/8" front, (US 4 only)                                       | W    | NC    |
| 1-1/4" x 8" front  | X    | 25    |
| 1-1/4" x 8-5/8" front<br>(A function, US 4 only)                     | Y    | 109   |
| Screws with Dust Box   | B10  | NC    |
| Solid latch for electric strike                                      | E1   | 20    |
| 4-7/8" Strikes: 1 Left / 1 Right                                     | S6   | 13    |
| Front 1-1/16" x 8"   | Z    | 25    |

| CYLINDER CAMS REQUIRED |                   |
|------------------------|-------------------|
| All Functions          | 2101 Straight Cam |

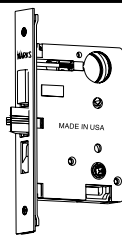
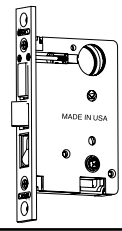
| Series 6  |                     | Standard Features   |               | Grade 2 for<br>Handlesets<br><br>Series 6<br>2-3/4" Backset<br>Series 8<br>2-1/2" Backset |
|---|---------------------|---|---------------|---|
|  |                     | <ul style="list-style-type: none"> <li>Backset: 2-3/4"</li> <li>Bolt throw: Cast alloy full 1" throw</li> <li>Latch throw: 5/8" (anti-friction)</li> <li>Case: High pressure cast Zamac, baked enamel finish</li> <li>Front: 1-1/4" x 8", Flat or 3° bevel</li> <li>Hubs: 9/32" (7.2mm) on square</li> </ul>            |               |   |
|  |                     | <ul style="list-style-type: none"> <li>Backset: 2-1/2"</li> <li>Bolt throw: Cast alloy full 1" throw</li> <li>Latch throw: Solid brass 1/2" throw, reversible</li> <li>Case: High pressure cast Zamac, baked enamel finish</li> <li>Front: 1-1/16" x 7-5/8", Flat or 3° bevel</li> <li>Hubs: 9/32" on square</li> </ul> |               |   |
| MARKS #   | FUNCTION            | ANSI #  | FINISH GROUPS |   |
| <b>KEYED SINGLE CYLINDER, NO DEADBOLT</b>   |                     |   |               |   |
| DW  | VESTIBULE           |   | 3, 32D        | 10, 10B, 32   |
| <b>KEYED SINGLE CYLINDER, WITH DEADBOLT</b>                                       |                     |   |               |   |
| A   | ENTRANCE            | F08, F10  | 325           | 342   |
| B   | ENTRANCE            | F21   |               |   |
| F   | DORMITORY           | F12   |               |   |
| <b>KEYED DOUBLE CYLINDER, WITH DEADBOLT</b>                                       |                     |   |               |   |
| AC  | ENTRANCE            | F35   | 341           | 358   |
| C   | STORE DOOR "B BODY" | F25   |               |   |
| SO  | STORE DOOR          | F25   |               |   |
| <b>MORTISE LOCK BODIES ARE PACKED 6 PER CASE</b>                                  |                     |   |               |   |

# MORTISE LOCK BODIES

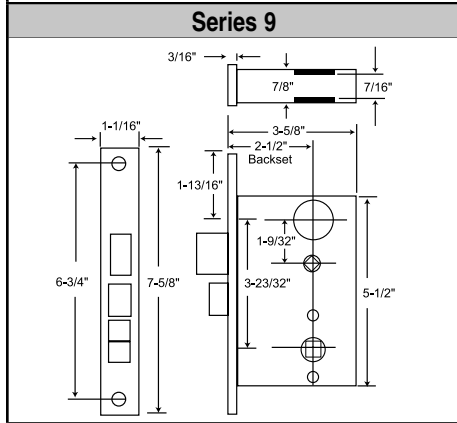
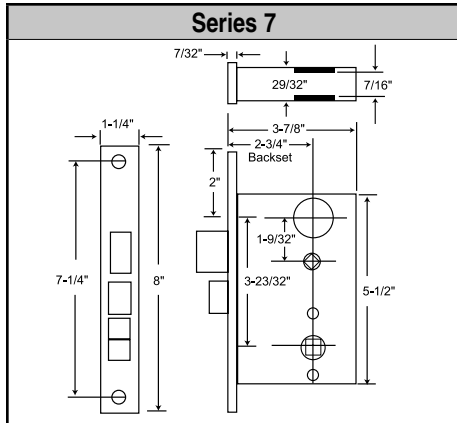

| OPTIONS  | CODE | PRICE |
|--|------|-------|
| 1-1/16" x 7-5/8" front   | T    | 27    |
| 1-1/4" x 10" front,<br>(A function, US 4 only),<br>no mounting holes | U    | 109   |
| 1" x 7-1/8" front, (US 4 only)                                       | W    | NC    |
| 1-1/4" x 8" front  | X    | 25    |
| 1-1/4" x 8-5/8" front<br>(A function, US 4 only)                     | Y    | 109   |
| 1-1/16" x 8"   |      |       |
| Pin and lever springs  | B5   | 37    |
| Screws with Dust Box   | B10  | NC    |
| Solid latch for electric strike                                      | E1   | 20    |
| 4-7/8" Strikes: 1 Left / 1 Right                                     | S6   | 13    |
| Front 1" x 8"  | Z    | 25    |

**CYLINDER CAMS REQUIRED**  
All functions      2101 Straight Cam

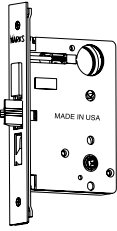
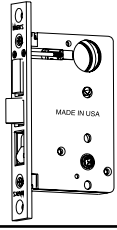
| Series 7  |                    | Standard Features  |   |               |             |
|---|--------------------|--|---|---------------|-------------|
|  |                    | <ul style="list-style-type: none"> <li>Backset: 2-3/4"</li> <li>Bolt throw: Cast alloy full 1" throw</li> <li>Latch throw: 5/8" (anti-friction)</li> <li>Case: High pressure cast Zamac, baked enamel finish</li> <li>Front: 1-1/4" x 8", Flat or 3° bevel</li> <li>Hubs: 9/32" on square steel, w/ security separator</li> </ul>                    | <b>Grade 2 for</b><br><b>Knobs &amp; Levers</b><br><b>Series 7</b><br><b>2-3/4" Backset</b><br><b>Series 9</b><br><b>2-1/2" Backset</b> |               |             |
|  |                    | <ul style="list-style-type: none"> <li>Backset: 2-1/2"</li> <li>Bolt throw: Cast alloy full 1" throw</li> <li>Latch throw: Solid brass 1/2" throw, reversible</li> <li>Case: High pressure cast Zamac, baked enamel finish</li> <li>Front: 1-1/16" x 7-5/8", Flat or 3° bevel</li> <li>Hubs: 9/32" on square steel, w/ security separator</li> </ul> |   |               |             |
| MARKS #   |                    | FUNCTION   | ANSI #  | FINISH GROUPS |             |
| <b>KEYED SINGLE CYLINDER, NO DEADBOLT</b>   |                    |  |   |               |             |
| D   | OFFICE / VESTIBULE |  |   | 3, 32D        | 10, 10B, 32 |
| DW  | VESTIBULE          |  |   | 277           | 294         |
| <b>KEYED SINGLE CYLINDER, WITH DEADBOLT</b>                                       |                    |  |   |               |             |
| A   | ENTRANCE           | F08, F10   |   | 292           | 308         |
| B   | ENTRANCE           | F21  |   |               |             |
| F   | DORMITORY          | F12  |   |               |             |
| FS  | DORMITORY          |  |   |               |             |
| FW  | DORMITORY          | F13  |   |               |             |
| <b>KEYED DOUBLE CYLINDER, WITH DEADBOLT</b>                                       |                    |  |   |               |             |
| AC  | ENTRANCE           | F35  |   | 322           | 339         |
| C   | STOREROOM          | F14  |   |               |             |
| FA  | DORMITORY          | F11  |   |               |             |
| FX  | DORMITORY          | F33  |   |               |             |
| <b>KEYLESS</b>  |                    |  |   |               |             |
| N   | PASSAGE            | F01  |   | 222           | 239         |
| L   | BATHROOM           | F02  |   | 292           | 308         |
| LF  | PRIVACY            | F19  |   |               |             |
| <b>MORTISE LOCK BODIES ARE PACKED 6 PER CASE</b>                                  |                    |  |   |               |             |



Mortise Parts, Trim

# MORTISE DEADLOCKS

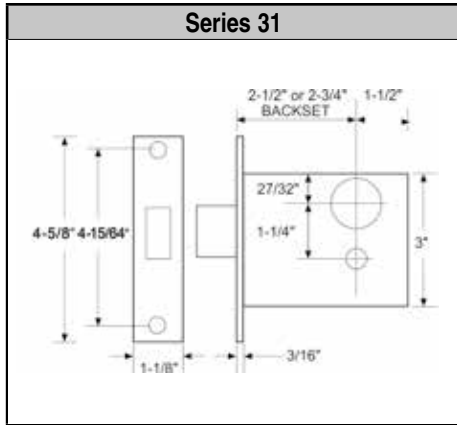
Mortise Parts, Trim



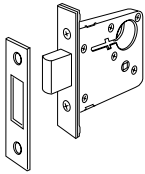

| OPTIONS                          | CODE | PRICE |
|----------------------------------|------|-------|
| Security Strike: 4-7/8" x 1-1/4" | S4   | 11    |

| Standard Features   |                             |        | Series 31<br>2-3/4" Backset   |                          |
|---|-----------------------------|--------|---|--------------------------|
|  <ul style="list-style-type: none"> <li>Backset: Series 31: 2-3/4"</li> <li>Bolt throw: 1" stainless steel with hardened roll pins</li> <li>Case: Stamped Steel, Grade 1</li> <li>Front: 1-1/16" x 4-5/8" adjustable bevel</li> <li>Cylinder: Solid brass cylinder, 6-pin, "C" keyway, 2 keys</li> <li>Strike: #4035 (Included) 1-1/8" x 3-1/8"</li> <li>Strike: #4035-1 (Optional) 1-1/8" x 3-1/2"</li> </ul> |                             |        |  |                          |
|   |                             |        |   |                          |
| MARKS #   | FUNCTION                    | ANSI # | 3, 32D  | 3E, 10, 10B, 26, 32, 32D |
| —   | LOCK ONLY                   | —      | 181   | 204                      |
| K, 31K  | CYLINDER x TURNPIECE        | E06071 | 239   | 262                      |
| L, 31L  | COMMUNICATING SINGLE CYL.   | E06081 | 214   | 237                      |
| M, 31M  | DOUBLE CYLINDER             | E06061 | 242   | 271                      |
| S, 31S  | CLASSROOM (Specify Handing) | E06091 | 271   | 295                      |
| X, 31X  | TURNPIECE ONLY              |        | 191   | 212                      |

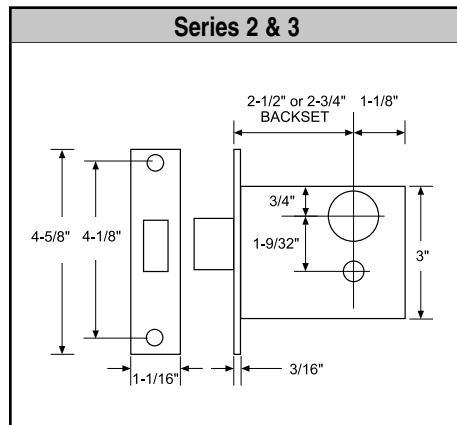
**MORTISE LOCK BODIES ARE PACKED 6 PER CASE**



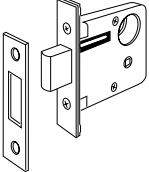

| OPTIONS                | CODE | PRICE |
|------------------------|------|-------|
| 1-1/16" x 5-5/8" front | R    | 28    |

| Standard Features  |                             |        | Series 2 • 2-1/2" Backset<br>Series 3 • 2-3/4" Backset                              |                          |
|--|-----------------------------|--------|---|--------------------------|
|  <ul style="list-style-type: none"> <li>Backset: Series 2: 2-1/2"; Series 3: 2-3/4"</li> <li>Bolt throw: 1"</li> <li>Case: High pressure cast</li> <li>Front: 1-1/16" x 4-5/8" flat or 3" bevel</li> <li>Cylinder: Solid brass cylinder, 6-pin, "C" keyway, 2 keys</li> <li>Strike: #4035 Included</li> </ul> |                             |        |  |                          |
|  |                             |        |   |                          |
| MARKS #  | FUNCTION                    | ANSI # | 3, 32D  | 3E, 10, 10B, 26, 32, 32D |
| —  | LOCK ONLY                   | —      | 127   | 149                      |
| K, 2K, 3K  | CYLINDER x TURNPIECE        | E06071 | 186   | 206                      |
| L, 2L, 3L  | COMMUNICATING SINGLE CYL.   | E06081 | 163   | 186                      |
| M, 2M, 3M  | DOUBLE CYLINDER             | E06061 | 196   | 217                      |
| S, 2S, 3S  | CLASSROOM (Specify Handing) | E06091 | 215   | 241                      |
| X, 2X, 3X  | TURNPIECE ONLY              |        | 137   | 157                      |

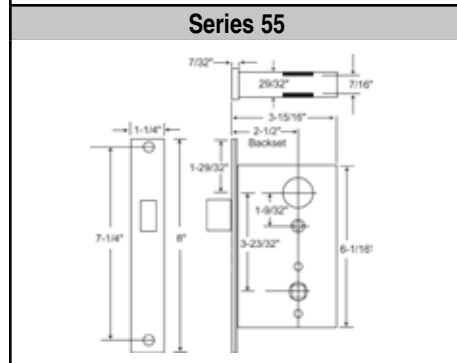
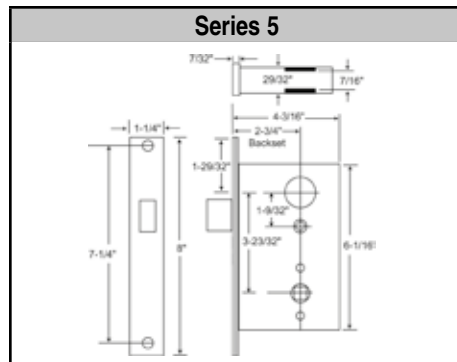
**MORTISE LOCK BODIES ARE PACKED 6 PER CASE**

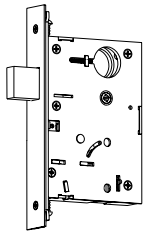

| Standard Features  |                      |        | Series 5 • 2-3/4" Backset<br>Series 55 • 2-1/2" Backset                               |                 |
|--|----------------------|--------|---|-----------------|
|  <ul style="list-style-type: none"> <li>Backset: Series 5: 2-3/4"; Series 55: 2-1/2"</li> <li>Bolt throw: Stainless steel full 1" throw</li> <li>Case: Stamped steel .090 thick, Zinc dichromate finish</li> <li>Front: 1-1/4" x 8" Adjustable bevel</li> </ul> |                      |        |  |                 |
|  |                      |        |   |                 |
| MARKS #  | FUNCTION             | ANSI # | 3, 32D  | 3E, 10, 10B, 32 |
| T, 5T  | DOUBLE CYLINDER      | F16    | 364   | 377             |
| P, 5P  | CYLINDER x TURNPIECE | F17    | 334   | 356             |
| S, 5S  | SINGLE CYLINDER*     | F18    | 308   | 332             |
| SC, 5SC  | CLASSROOM*           | F29    | 356   | 377             |

**MORTISE LOCK BODIES ARE PACKED 6 PER CASE**  
\*NOTE: Specify handing on "S" and "SC" functions

| OPTIONS                 | CODE | PRICE |
|-------------------------|------|-------|
| 1-1/16" x 7-5/8" front  | T    | 27    |
| 1" x 7-3/4" front       | V    | 27    |
| 1" x 1/16" x 8"         | Q    | 27    |
| Lead lined mortise lock | F1   | 325   |

# MORTISE LOCKSET FUNCTIONS

| ANSI # | TYPE            | MARKS FUNCTION | ANSI # | TYPE            | MARKS FUNCTION | ANSI # | TYPE            | MARKS FUNCTION | ANSI # | TYPE            | MARKS FUNCTION |
|--------|-----------------|----------------|--------|-----------------|----------------|--------|-----------------|----------------|--------|-----------------|----------------|
| F01    | Non-Keyed       | N              | F10    | Single Cylinder | A              | F19    | Non-Keyed       | LF             | F29    | Deadbolt        | SC             |
| F02    | Non-Keyed       | L              | F11    | Double Cylinder | FA             | F20    | Single Cylinder | FD             | F30    | Double Cylinder | WW             |
| F04    | Single Cylinder | E              | F12    | Single Cylinder | F              | F21    | Single Cylinder | B              | F31    | Non-Keyed       | EX             |
| F05    | Single Cylinder | J              | F13    | Single Cylinder | FW             | F22    | Non-Keyed       | LJ             | F32    | Double Cylinder | GC             |
| F06    | Single Cylinder | JM             | F14    | Double Cylinder | C              | F24    | Double Cylinder | C              | F33    | Double Cylinder | FX             |
| F06    | Single Cylinder | JR             | F15    | Single Cylinder | H              | F25    | Double Cylinder | C              | F34    | Double Cylinder | FC             |
| F07    | Single Cylinder | EW             | F16    | Deadbolt        | T              | F25    | Double Cylinder | SO             | F35    | Double Cylinder | AC             |
| F08    | Single Cylinder | A              | F17    | Deadbolt        | P              | F26    | Single Cylinder | GL             |        |                 |                |
| F09    | Double Cylinder | G              | F18    | Deadbolt        | S              | F27    | Auto Deadbolt   | AD             |        |                 |                |

## SINGLE CYLINDER FUNCTIONS

| ANSI #   | Cam  | Strike | Marks Function |     |
|--|------|--------|----------------|-----|
|  |      |        | I/S            | O/S |
| <b>F04: OFFICE</b><br>Latch by knob/lever either side except when outside knob/lever locked by stop-button in front; then by key outside. Auxiliary latch deadlocks latch. Inside always open.   |      |        |                |     |
|  | 2101 | 5036   |                | E   |
| <b>F04: OFFICE</b><br>Latch by knob/lever either side except when outside knob/lever locked by turn piece inside; then by key outside. Auxiliary latch deadlocks latch. Inside always open.  |      |        |                |     |
|  | 2105 | 5036   |                | K   |
| <b>F05: CLASSROOM</b><br>Latch by knob/lever either side except when outside knob/lever locked by key. When locked, latch bolt retracted by key. Inside always open. Auxiliary latch deadlocks latch.  |      |        |                |     |
|  | 2105 | 5036   |                | J   |
| <b>F06: HOLDBACK "A"</b><br>Latch by knob/lever either side except when outside knob/lever locked or unlocked by key. Auxiliary latch deadlocks latch. Inside always open. Inside knob/lever unlocks outside lever. Latch bolt can be locked in retracted position by locking inside hub. Can be used with blank outside trim.                   |      |        |                |     |
|  | 2105 | 5036   |                | JM  |
| <b>F06: HOLDBACK "B"</b><br>Latch by knob/lever either side except when outside knob/lever locked or unlocked by key. Auxiliary latch deadlocks latch. Inside always open. Inside knob/lever will not unlock outside knob/lever. Latch bolt can be locked in retracted position by locking outside hub. Can not be used with blank outside trim. |      |        |                |     |
|  | 2105 | 5036   |                | JR  |
| <b>F07: STOREROOM</b><br>Latch by knob/lever inside, key outside. Outside knob/lever always rigid. Auxiliary latch deadlocks latch. Inside always open.  |      |        |                |     |
|  | 2101 | 5036   |                | EW  |
| <b>F08, F10: ENTRANCE</b><br>Latch by knob/lever either side except when outside locked by stop-button; then by key outside, knob/lever inside. Deadbolt by key outside, turnpiece inside. Deadbolt deadlocks latch.   |      |        |                |     |
|  | 2102 | 9035   |                | A   |
| <b>F12: DORMITORY</b><br>Latch by knob/lever either side except when outside knob/lever locked by stop-button or projected deadbolt. Deadbolt by turnpiece inside. Inside knob/lever retracts latch and deadbolt simultaneously, leaving outside locked. Deadbolt deadlocks latch.   |      |        |                |     |
|  | 2102 | 9035   |                | F   |
| <b>F13: DORMITORY</b><br>Latch by knob/lever either side except when projected deadbolt locks outside knob/lever and deadlocks latch. Deadbolt and latch by key outside. Deadbolt by turnpiece inside. Inside knob/lever retracts latch and deadbolt simultaneously, automatically unlocking outside knob/lever.                                 |      |        |                |     |
|  | 2102 | 9035   |                | FW  |
| <b>F15: HOTEL</b><br>Inside knob/lever always free, outside rigid. Latch by knob/lever inside, key outside. (When deadbolt projected by turnpiece all keys are shut out except emergency key). Inside knob/lever retracts deadbolt and latch simultaneously. Auxiliary latch or deadbolt deadlocks latch. Indicator available.                   |      |        |                |     |
|  | 2102 | 5035   |                | H   |
| <b>F20: APARTMENT</b><br>Latch by knob/lever either side except when outside locked by stop-button or projected deadbolt. Latch deadlocked by auxiliary latch or deadbolt. Deadbolt and latch by key outside. Deadbolt by turnpiece inside. Inside knob/lever retracts latch & deadbolt simultaneously, leaving outside locked.                  |      |        |                |     |
|  | 2102 | 5035   |                | FD  |

## SINGLE CYLINDER FUNCTIONS

| ANSI #   | Cam  | Strike | Marks Function |     |
|--|------|--------|----------------|-----|
|  |      |        | I/S            | O/S |
| <b>F21: ENTRANCE</b><br>Latch by knob/lever either side. Deadbolt by key outside, turnpiece inside. Deadbolt deadlocks latch.  |      |        |                |     |
|  | 2102 | 9035   |                | B   |
| <b>F26: INSTITUTIONAL PRIVACY</b><br>Latch by knob/lever either side except when outside knob/lever locked by inside turn piece. Latch deadlocked by auxiliary latch. Key outside opens latch. When outside locked, inside knob/lever retracts latch, automatically unlocking outside knob/lever.  |      |        |                |     |
|  | 2101 | 5036   |                | GL  |
| <b>F27: Auto Deadbolt</b><br>Depressing auxiliary latch projects deadbolt and deadlocks latch. Remains locked even if auxiliary latch is extended. Inside knob/lever retracts both bolts simultaneously. When outside is locked, both bolts are retracted by override key with outside knob/lever. |      |        |                |     |
|  | 2101 | 5035   |                | AD  |
| <b>OFFICE VESTIBULE:</b><br>Latch by knob/lever either side except when outside knob/lever locked by stop-button in front; then by key outside.  |      |        |                |     |
|  | 2101 | 9035   |                | D   |
| <b>VESTIBULE:</b><br>Latch by knob/lever inside, key outside. Outside knob/lever always rigid.   |      |        |                |     |
|  | 2101 | 9035   |                | DW  |
| <b>DORMITORY:</b><br>Latch by knob/lever inside. Outside knob/lever always rigid. Deadbolt and latch by key outside. Deadbolt by turnpiece inside. When deadbolt is projected, latch is deadlocked. Inside knob/lever retracts latch and deadbolt simultaneously.                                  |      |        |                |     |
|  | 2102 | 9035   |                | FS  |
| <b>SPECIAL PRIVACY:</b><br>Inside knob/lever always free, outside rigid. Latch by knob/lever inside, key outside. Deadbolt by turnpiece inside, emergency release outside. Inside knob/lever retracts deadbolt and latch simultaneously. Auxiliary latch deadlocks latch.                          |      |        |                |     |
|  | 2102 | 5035   |                | LH  |
| <b>STOREROOM:</b><br>Latch by thumbpiece inside. Key outside.  |      |        |                |     |
|  | 2101 | 9035   |                | DN  |
| <b>STOREROOM:</b><br>Latch by thumbpiece or knob/lever inside. Key outside. Auxiliary latch deadlocks latch.   |      |        |                |     |
|  | 2101 | 5036   |                | EN  |
| <b>ELECTRIFIED FUNCTIONS</b>   |      |        |                |     |
| <b>ELECTRICALLY LOCKED (Fail Safe):</b><br>Outside always locked electrically. Open by key outside, switch or loss of power. Auxiliary latch deadlocks latch. Inside always open.  |      |        |                |     |
|  | 2101 | 5036   |                | EL  |
| <b>ELECTRICALLY UNLOCKED (Fail Secure):</b><br>Outside always locked until unlocked by key or electrically energized. Auxiliary latch deadlocks latch. Inside always open.   |      |        |                |     |
|  | 2101 | 5036   |                | EU  |

Mortise Parts, Trim









# MORTISE LOCKSET FUNCTIONS

| DOUBLE CYLINDER FUNCTIONS  |                    |        |                |    |
|--|--------------------|--------|----------------|----|
| ANSI #   | Cam                | Strike | Marks Function |    |
| <b>F09: ENTRANCE</b><br>Latch by knob/lever either side except when outside knob/lever locked by key inside, latch retracted by key outside. Outside remains locked. Auxiliary latch deadlocks latch.  | IS<br>2101<br>2106 | 5036   | IS O/S         | G  |
| <b>F11: DORMITORY</b><br>Latch by knob/lever either side except when outside knob/lever locked by stop-button or projected deadbolt. Deadbolt by key either side. Inside knob/lever retracts latch and deadbolt simultaneously leaving outside locked. Deadbolt deadlocks latch.   | IS<br>2102         | 9035   |                | FA |
| <b>F14: STOREROOM</b><br>Latch by knob/lever either side. Deadbolt by key either side. Deadbolt deadlocks latch.   | IS<br>2102         | 9035   |                | C  |
| <b>F24: APARTMENT HANDLE</b><br>Latch by thumbpiece either side except when outside is locked by key inside. When outside is locked, latch retracted by key outside or thumbpiece inside. Auxiliary latch deadlocks latch.   | IS<br>2101<br>2106 | 5036   |                | G  |
| <b>F25: STOREROOM "B" Body</b><br>Latch by thumbpiece either side. Deadbolt by key either side.  | IS<br>2102         | 9035   |                | C  |
| <b>F25: STOREROOM</b><br>Latch by thumbpiece either side except when outside thumbpiece locked by stop-button in front; then by key outside. Deadbolt by key both sides. Deadbolt deadlocks latch.   | IS<br>2102         | 9035   |                | SO |
| <b>F30: INSTITUTION</b><br>Both knob/levers rigid. Auxiliary latch deadlocks latch. Latch by key either side.  | IS<br>2101         | 5036   |                | WW |
| <b>F32: INTRUDER LATCH BOLT</b><br>Latch by knob/lever either side except when outside knob/lever is locked from inside or outside by key. Latch operated by key from inside or outside. Auxiliary latch, deadlocks latch. Inside always open.   | IS<br>2105         | 5036   |                | GC |
| <b>CLASSROOM SECURITY</b><br>Latch bolt retracted by knob/lever from either side unless outside is locked by key from either side. Auxiliary latch deadlocks latch bolt when door is locked. Inside knob/lever is always free for immediate egress.  | IS<br>2101         | 5036   |                | GG |
| <b>CLASSROOM SECURITY</b><br>Latch by lever either side except when outside lever is locked or unlocked by key from either side. With outside locked, exterior key will retract the latch allowing the outside to remain locked. Inside always free for egress. Auxiliary latch deadlocks latch.   | IS<br>2101<br>2105 | 5036   |                | GJ |
| <b>CLASSROOM SECURITY w/HOLDBACK</b><br>Latch bolt retracted by knob/lever from either side unless outside is locked by key from either side. When locked, latch bolt retracted by key outside or knob/lever inside. Auxiliary latch deadlocks latch bolt when door is locked. Depress inside knob/lever and turn key 360° for holdback feature. Inside knob/lever always free for immediate egress. | IS<br>2101<br>2105 | 5036   |                | GR |
| <b>F33: DORMITORY</b><br>Latch by knob/lever either side except when projected deadbolt locks outside knob/lever and deadlocks latch. Deadbolt and latch by key either side. Inside knob/lever retracts latch and deadbolt simultaneously, automatically unlocking outside knob/lever.   | IS<br>2102         | 9035   |                | FX |
| <b>F33: DORMITORY</b><br>Latch by knob/lever either side except when projected deadbolt locks outside knob/lever and deadlocks latch. Deadbolt and latch by key either side. Inside knob/lever retracts latch and deadbolt simultaneously, automatically unlocking outside knob/lever.   | IS<br>2102         | 5035   |                | FC |

| DOUBLE CYLINDER FUNCTIONS (Con't)  |            |        |                |    |
|--|------------|--------|----------------|----|
| ANSI #   | Cam        | Strike | Marks Function |    |
| <b>F35: STORE DOOR</b><br>Latch by knob/lever either side except when outside knob/lever locked by stop-button in front; then by key outside. Deadbolt by key either side. Deadbolt deadlocks latch.   | IS<br>2102 | 9035   |                | AC |
| NON-KEYED FUNCTIONS  |            |        |                |    |
| ANSI #   |            | Strike | Marks Function |    |
| <b>F01: PASSAGE</b><br>Latch by knob/lever either side.  |            | 9035   | IS O/S         | N  |
| <b>F02: BATHROOM*</b><br>Latch by knob/lever either side. Deadbolt by turnpiece inside. Deadbolt deadlocks latch. To unlock from outside, remove emergency button, insert emergency key in access hole and turn. Optional coinkey assembly available.  |            | 9035   |                | L  |
| <b>F19: PRIVACY*</b><br>Latch by knob/lever either side except when projected deadbolt locks outside knob/lever and deadlocks latch. Deadbolt by turnpiece inside. Inside knob/lever retracts latch and deadbolt simultaneously, automatically unlocking outside knob/lever. To unlock from outside, remove emergency button, insert emergency key in access hole and turn. Optional coinkey assembly available. |            | 9035   |                | LF |
| <b>F22: PRIVACY</b><br>Latch by knob/lever either side except when outside knob/lever is locked by inside turnpiece. Turning inside knob/lever or closing door unlocks outside lever. To unlock from outside, remove emergency button, insert emergency key in access hole and turn. Optional coinkey assembly available.  |            | 9035   |                | LJ |
| <b>F31: EXIT</b><br>Latch by knob/lever inside, no trim outside. Auxiliary latch deadlocks latch. None removable blank trim: F26 option  |            | 5036   |                | EX |
| DEADBOLT FUNCTIONS   |            |        |                |    |
|  | IS         | Cam    |                |    |
| <b>F16: DEADLOCK</b><br>Deadbolt by key either side.   | 2102       | 2102   | 9035           | T  |
| <b>F17: DEADLOCK</b><br>Deadbolt by key outside and turnpiece inside.  |            | 2102   | 9035           | P  |
| <b>F18: DEADLOCK</b><br>Deadbolt by key one side only.   |            | 2102   | 9035           | S  |
| <b>F29: DEADLOCK</b><br>Deadbolt by key outside. Inside turnpiece will retract but will not project deadbolt.  |            | 2102   | 9035           | SC |
| <b>DEADBOLT</b><br>Latch by knob/lever either side. Deadbolt by key either side; latch remained unlocked at all times. Note: With this function deadbolt protrusion is 13/16   |            | 2102   | 9035           | CT |
| DEADBOLT FUNCTIONS   |            |        |                |    |
| <b>E06072: CYLINDER BY TURNPIECE</b><br>Deadbolt by inside turnpiece or outside key.   |            | 2102   |                | K  |
| <b>E06082: COMMUNICATING SINGLE CYLINDER*</b><br>Deadbolt by key from one side only.   |            | 2102   |                | L  |
| <b>E06062: DOUBLE CYLINDER</b><br>Deadbolt by key either side.   |            | 2102   |                | M  |
| <b>E06092: CLASSROOM</b><br>Deadbolt by outside key. Turnpiece will retract but not project deadbolt.  |            | 2102   |                | S  |
| <b>TURNPIECE</b><br>Deadbolt by inside turnpiece.  |            | 2102   |                | X  |
| <b>*PRIVACY INDICATOR AVAILABLE</b>  |            |        |                |    |



# MORTISE LOCKSET PARTS RK, RL

|              |   |   |   |   |  |  |  |
|--------------|---|---|---|---|--|--|--|
| <b>ROSES</b> | RR: 2-9/16" dia.  | RW: 2-9/16" dia.  | RQ: 2-1/4" dia.   | RS: 2-1/4" dia.   | RX: 2-1/2" sq.   | *RK: 2-1/2" sq.  | *RL: 2-1/2" sq.  |
|              |  |  |  |  |  Wrought |  Forged |  Forged |

## Knob / Rose Kits

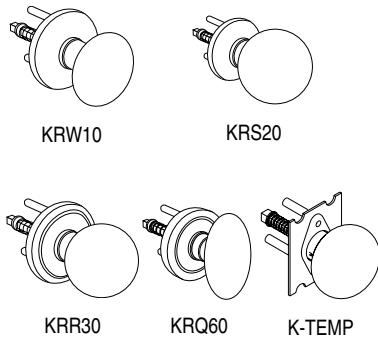

| ROSE WITH RING   | PLAIN ROSE | SMALL ROSE W/RING | SMALL ROSE | DESCRIPTION                | FINISH GROUPS |     |         |     |     |     | ROSE RK* |
|------------------|------------|-------------------|------------|----------------------------|---------------|-----|---------|-----|-----|-----|----------|
|                  |            |                   |            |                            | 3             | 3E  | 10, 10B | 15  | 26  | 32D |          |
| KRR10            | KRW10      | KRQ10             | KRS10      | Round knob/ball assembly   | 195           | —   | —       | —   | —   | 195 | +106     |
| KRR20            | KRW20      | KRQ20             | KRS20      | Ball knob/ball assembly    |               |     |         |     |     |     |          |
| KRR30            | KRW30      | KRQ30             | KRS30      | Ball knob/ball assembly    | —             | 212 | 251     | 284 | 284 | —   |          |
| KRR60            | KRW60      | KRQ60             | KRS60      | Eclipse knob/ball assembly |               |     |         |     |     |     |          |
| <b>NO FINISH</b> |            |                   |            |                            |               |     |         |     |     |     |          |
| K-TEMP           |            |                   |            | Temporary Trim             | 66            |     |         |     |     |     |          |
| K-TEMP-G3        |            |                   |            | Temporary Trim less cyl    | 50            |     |         |     |     |     |          |

Complete knob/rose assemblies both sides (includes spindles).

## Lever / Rose Kits

\* Specify handing

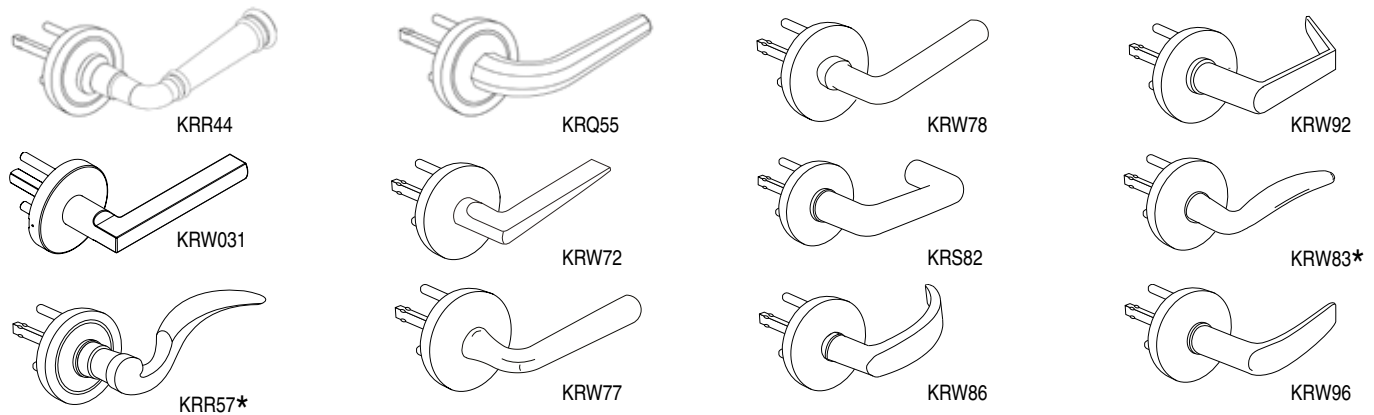

| PART #            |                         | DESCRIPTION   | FINISH GROUPS |     |             |     |     |     | ROSE RK*              | ROSE RL*             |
|-------------------|-------------------------|---|---------------|-----|-------------|-----|-----|-----|-----------------------|----------------------|
| ROSE WITH RING RR | SMALL ROSE WITH RING RQ |   | 3E            | 4   | 10, 10B, 26 | 15  | 26D | 32D |                       |                      |
|                   |                         | <b>Complete lever/rose assemblies both sides (includes spindles).</b> |               |     |             |     |     |     |                       |                      |
| KRR44             | KRQ44                   | Stanhope lever/rose kit   | 208           | 312 | 312         | 312 | 312 | —   | +106 FOR ALL FINISHES | +31 FOR ALL FINISHES |
| KRR57             | KRQ57                   | Monaco lever/rose kit   | 208           | 312 | 312         | 312 | —   | —   |                       |                      |
| KRR55             | KRQ55                   | Brompton lever/rose kit   | 208           | 312 | 312         | 312 | —   | —   |                       |                      |
|                   |                         | <b>Complete lever/rose assemblies both sides (includes spindles).</b> |               |     |             |     |     |     |                       |                      |
| KRW031            | KRS031                  | Copa lever/rose kit   | 312           | 312 | —           | 312 | 312 | —   | +106 FOR ALL FINISHES | 31 FOR ALL FINISHES  |
| KRW72             | KRS72                   | Towne lever/rose kit  | 312           | 312 | 312         | 312 | 353 | —   |                       |                      |
| KRW77             | KRS77                   | Maxwell lever/rose kit  | 312           | 312 | 312         | 312 | 353 | 332 |                       |                      |
| KRW78             | KRS78                   | Omni lever/rose kit   | 312           | 312 | 312         | 312 | 353 | 332 |                       |                      |
| KRW82             | KRS82                   | Plaza lever/rose kit  | 312           | 312 | 312         | 312 | 353 | 332 |                       |                      |
| KRW83             | KRS83                   | Dayton lever/rose kit   | 312           | 312 | 312         | 312 | 353 | 332 |                       |                      |
| KRW86             | KRS86                   | Crescent lever/rose kit   | 312           | 312 | 312         | 312 | 353 | —   |                       |                      |
| KRW92             | KRS92                   | American lever/rose kit   | 312           | 312 | 312         | 312 | 353 | 332 |                       |                      |
| KRW96             | KRS96                   | Titan lever/rose kit  | 312           | 312 | 312         | 312 | 353 | 332 |                       |                      |

Mortise Parts, Trim

# MORTISE LOCKSET PARTS

## Dummy Cylinder, Collars & Turnpieces

Mortise Parts, Trim

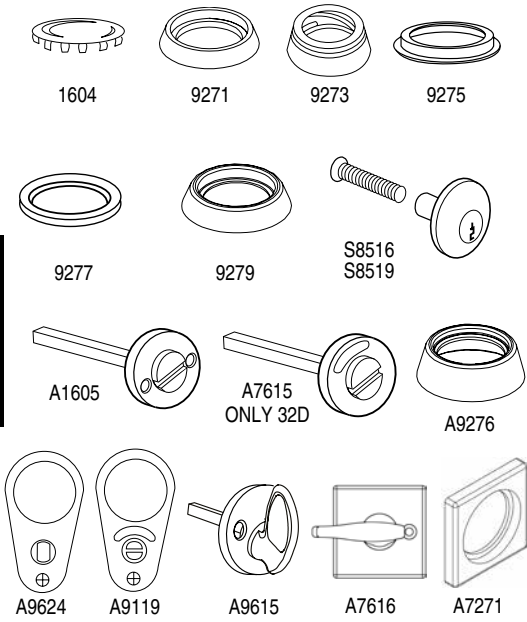

| PART # | DESCRIPTION                                   | FINISH GROUPS |        |    |             |    |     |
|--------|---|---------------|--------|----|-------------|----|-----|
|        |   | 3E            | 3, 26D | 4  | 10, 10B, 26 | 32 | 32D |
| 1604   | Emergency hole cover                          | —             | 9      | —  | —           | —  | —   |
| 9271   | Tapered collar, solid brass, 5/16" high       | 31            | 23     | —  | 23          | 27 | 23  |
| 9273   | Spring collar, 7/16" high                     | —             | 14     | —  | —           | —  | —   |
| 9275   | Mortise spacer, wrought brass, 1/8" high      | —             | 8      | —  | —           | —  | —   |
| 9277   | Plastic spacer ring, 1/16"                    | 6             | —      | —  | —           | —  | —   |
| 9279   | Tapered collar, wrought brass, 3/8" high      | 21            | 16     | —  | 21          | 18 | 16  |
| S8516  | Dummy cylinder, inside                        | 41            | 41     | —  | 41          | —  | —   |
| S8519  | Dummy cylinder, outside                       | 41            | 41     | —  | 41          | —  | —   |
| A1605  | Emergency coinkey                             | 69            | 63     | 63 | 63          | —  | —   |
| A7271  | Square cylinder collar, 1-3/4" x 5/16"        | 42            | 36     | —  | 36          | 36 | 36  |
| A7615  | Occupancy indicator                           | —             | —      | —  | —           | —  | 52  |
| A7616  | Square Turnpiece Rose                         | 75            | 57     | 75 | 66          | 66 | 66  |
| A9276  | Collar, wrought brass w/insert, 1/2" high     | —             | 21     | —  | 29          | 29 | 29  |
| A9624  | Hotel indicator plate ass'y for rose trim     | 89            | 66     | —  | 71          | —  | —   |
| A9119  | Occupancy indicator plate ass'y for rose trim | —             | 102    | —  | —           | —  | —   |
| A9615  | Turnpiece                                     | 64            | 46     | 64 | 54          | —  | 54  |

## Strikes

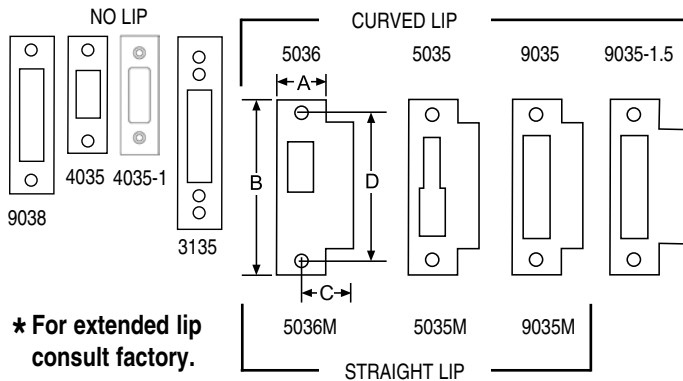

| TYPE         | PART #   | A                                 | B      | C*     | D      | FINISH GROUPS |                     |
|--------------|----------|-----------------------------------|--------|--------|--------|---------------|---------------------|
|              |          |                                   |        |        |        | S3            | 3, 10, 10B, 32, 32D |
| No Lip       | 4035     | 1-1/8"                            | 3-1/8" | —      | —      | 8             | 16                  |
|              | 4035-1   | 1-1/8"                            | 3-1/2" | 3-1/2" | 2-1/2" |               |                     |
|              | 9038     | 1-1/8"                            | 4-7/8" | —      | 2-1/2" | 9             | —                   |
|              | 3135     | 1-1/4"                            | 4-7/8" | —      | —      | —             | 21                  |
| Curved Lip   | 5035 †   | 1-1/4"                            | 4-7/8" | 1-1/4" | 4-1/8" | —             | 23                  |
|              | 5036 †   | 1-1/4"                            | 4-7/8" | 1-1/4" | 4-1/8" | —             | 23                  |
|              | 9035     | 1-1/4"                            | 4-7/8" | 1-1/4" | 4-1/8" | 8             | 23                  |
|              | 9035-1.5 | 1-1/4"                            | 4-7/8" | 1-1/2" | 4-1/8" | —             | 36                  |
| Straight Lip | 5035M †  | 1-1/4"                            | 4-7/8" | 7/8"   | 4-1/8" | —             | 28                  |
|              | 5036M †  | 1-1/4"                            | 4-7/8" | 7/8"   | 4-1/8" | —             | 28                  |
|              | 9035M    | 1-1/4"                            | 4-7/8" | 7/8"   | 4-1/8" | —             | 28                  |
| Dust Box     | 9036     | Dust box for 9038 strike, plastic |        |        |        | 8             | —                   |
|              | 4036     | Dust box for 4035 strike, plastic |        |        |        | 6             | —                   |

† Specify handing.  
Extended lip strikes from 1-1/4" - 2", Add \$16.  
\*Extended lip strikes over 2", consult factory.

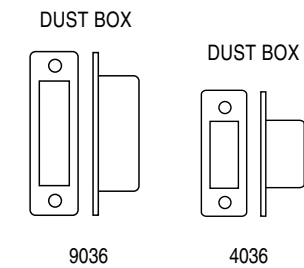

## Spindles

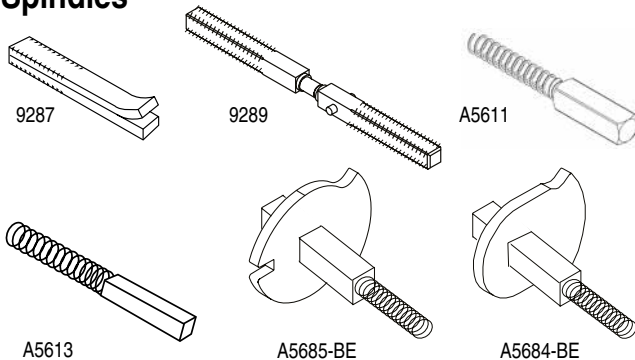

| PART #   | DESCRIPTION   |    |
|----------|---|----|
| 9287     | 2-1/2" LONG, HOOK SPINDLE, 2 PIECE                  | 14 |
| 9289     | 4-3/4" LONG, SWIVEL SPINDLE                         | 14 |
| A5611    | SPINDLE/SPRING ASSEMBLY FOR LEVERS, 5/16", 1" L     | 14 |
| A5613    | SPINDLE/SPRING ASSEMBLY FOR LEVERS, 5/16", 1-5/8" L | 14 |
| A5685-BE | CAM/SPINDLE SPRING ASSEMBLY EXTERIOR                | 23 |
| A5684-BE | CAM/SPINDLE SPRING ASSEMBLY INTERIOR                | 23 |

# TRIM LOCK PARTS

| How to Order Example<br>for Knob & Lever Assemblies |                               |             |                                |              |                     |             |                      |
|---|-------------------------------|-------------|--------------------------------|--------------|---------------------|-------------|----------------------|
| <b>DV</b>   | <b>02</b>                     | <b>-</b>    | <b>30</b>                      | <b>/</b>     | <b>15</b>           | <b>-</b>    | <b>G3</b>            |
| 1.<br><i>Plate/Rose Design</i>                      | 2.<br><i>Trim Description</i> | <i>Dash</i> | 3.<br><i>Knob/Lever Design</i> | <i>Slash</i> | 4.<br><i>Finish</i> | <i>Dash</i> | 5.<br><i>Options</i> |

| PLATE/ROSE DESIGN   | TRIM DESCRIPTION  | KNOB DESIGN  | FINISH   | OPTIONS   |
|---|---|--|--|---|
| <input type="checkbox"/> BA <input type="checkbox"/> RR<br><input type="checkbox"/> CL <input type="checkbox"/> RW<br><input type="checkbox"/> CP <input type="checkbox"/> RQ<br><input type="checkbox"/> CR <input type="checkbox"/> RS<br><input type="checkbox"/> DR <input type="checkbox"/> RX<br><input type="checkbox"/> DV<br><input type="checkbox"/> GC<br><input type="checkbox"/> MA<br><input type="checkbox"/> NY<br><input type="checkbox"/> NS<br><input type="checkbox"/> TN | <input type="checkbox"/> 01 Outside knob/lever/cylinder<br><input type="checkbox"/> 02 Inside knob/lever/turnpiece<br><input type="checkbox"/> 03 Inside knob/lever/cylinder<br><input type="checkbox"/> 04 Inside knob/lever only<br><input type="checkbox"/> 05 Outside cylinder only<br><input type="checkbox"/> 06 Outside knob/lever<br>/emergency coinkey<br><input type="checkbox"/> 07 Outside hotel<br><input type="checkbox"/> 08 Outside knob/lever only | <input type="checkbox"/> 10<br><input type="checkbox"/> 20<br><input type="checkbox"/> 30<br><input type="checkbox"/> 60<br><br><b>LEVER DESIGN</b><br><input type="checkbox"/> 44 <input type="checkbox"/> 82<br><input type="checkbox"/> 55 <input type="checkbox"/> 83<br><input type="checkbox"/> 57 <input type="checkbox"/> 86<br><input type="checkbox"/> 72 <input type="checkbox"/> 92<br><input type="checkbox"/> 77 <input type="checkbox"/> 96<br><input type="checkbox"/> 78 <input type="checkbox"/> 031 | <input type="checkbox"/> 3<br><input type="checkbox"/> 3E<br><input type="checkbox"/> 4<br><input type="checkbox"/> 10<br><input type="checkbox"/> 10B<br><input type="checkbox"/> 15<br><input type="checkbox"/> 26<br><input type="checkbox"/> 26D<br><input type="checkbox"/> 32D<br><input type="checkbox"/> Special | <hr/> <hr/> <hr/> <hr/> <hr/> <hr/> <hr/> <hr/><br>Specify<br><ul style="list-style-type: none"> <li>• Keying</li> <li>• Handing</li> <li>• Door Thickness</li> </ul> |







Mortise Parts, Trim







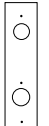

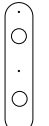
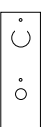
| How to Order Example<br>for Handle Assemblies |              |                     |             |                      |
|---|--------------|---------------------|-------------|----------------------|
| <b>PO41-39</b>                                | <b>/</b>     | <b>15</b>           | <b>-</b>    | <b>G3</b>            |
| 1.<br><i>Handle Assembly Design</i>           | <i>Slash</i> | 2.<br><i>Finish</i> | <i>Dash</i> | 3.<br><i>Options</i> |

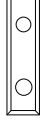
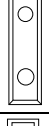
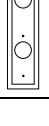
| PLATE/ROSE DESIGN   | FINISH   | OPTIONS   |
|---|--|---|
| <input type="checkbox"/> CR41-39 Crown <input type="checkbox"/> TN41-39 Towne | <input type="checkbox"/> 3E<br><input type="checkbox"/> 15<br><input type="checkbox"/> Special | <hr/> <hr/> <hr/> <hr/> <hr/> <hr/> <hr/> <hr/><br>Specify<br><ul style="list-style-type: none"> <li>• Keying</li> <li>• Handing</li> <li>• Door Thickness</li> </ul> |

# TRIM LOCK PARTS

















Mortise Parts, Trim

| PLATE/ROSE DESIGN   | 3   | 3E  | 10  | 10B | 15  | 26D | 32D |
|---|-----|-----|-----|-----|-----|-----|-----|
| BARRIER<br>BA    | —   | —   | —   | —   | —   | —   | 229 |
| CLASSIC<br>CL    | 80  | —   | 80  | 80  | —   | 81  | 94  |
| CAPITOL<br>CP    | 129 | —   | 127 | 127 | —   | —   | 118 |
| CROWN<br>CR      | 163 | —   | 186 | 186 | 163 | 163 | 163 |
| DRAKE<br>DR     | 197 | —   | 215 | 215 | 197 | 197 | 204 |
| DAVOS<br>DV    | 266 | —   | 289 | 289 | 266 | 266 | —   |
| MADISON<br>MA  | —   | 214 | —   | —   | 250 | —   | —   |
| SCHOOL<br>LA   | —   | —   | —   | —   | —   | —   | 186 |

| PLATE/ROSE DESIGN   | 3       | 3E  | 10  | 10B | 15  | 26D | 32D |
|---|---------|-----|-----|-----|-----|-----|-----|
| NEW YORKER<br>NY<br>10" PLATE             | 46      | —   | —   | —   | —   | 56  | —   |
| NEW YORKER<br>NS<br>7" PLATE              | 34      | —   | —   | —   | —   | 46  | —   |
| TOWNE<br>TN                               | —       | 214 | —   | —   | 251 | —   | —   |
| 2-9/16" DIA.<br>ROSE W-RING<br>RR         | 108     | 141 | 130 | 130 | 119 | 108 | 108 |
| 2-9/16" DIA.<br>PLAIN ROSE<br>RW         | 108     | 141 | 130 | 130 | 119 | 108 | 108 |
| 2-1/4" DIA.<br>SMALL ROSE<br>W-RING RQ  | 108     | 141 | 130 | 130 | 119 | 108 | 108 |
| 2-1/4" DIA.<br>SMALL ROSE<br>RS         | 108     | 141 | 130 | 130 | 119 | 108 | 108 |
| 2-1/2" SQ.<br>SQUARE<br>ROSE RX         | 108     | 141 | 130 | 130 | 119 | 108 | 108 |
| 2-1/2" SQ.<br>SQUARE<br>ROSE RK         | OUTSIDE | 181 | 212 | 201 | 201 | 191 | 181 |
|   | INSIDE  | 192 | 223 | 213 | 213 | 202 | 192 |
| SQUARE<br>TURNPIECE<br>ROSE<br>A7616    | 59      | 75  | 66  | 66  | 66  | 66  | 66  |
| 2-1/2" SQ.<br>SQUARE<br>ROSE RL         | 192     | 223 | 213 | 213 | 202 | 192 | 192 |

# TRIM LOCK PARTS

## Knob / Lever Design

| KNOB/LEVER  | FINISH GROUPS |     |     |     |     |     |     |     |     |  |
|---|---------------|-----|-----|-----|-----|-----|-----|-----|-----|--|
|   | 3             | 3E  | 4   | 10  | 10B | 15  | 26  | 26D | 32D |  |
| ROUND KNOB  10       | 96            | —   | —   | 117 | 117 | —   | 117 | 117 | 96  |  |
| BALL KNOB  20        | 96            | —   | —   | 117 | 117 | —   | 117 | 117 | 96  |  |
| BALL KNOB  30        | —             | 163 | —   | —   | —   | 205 | 205 | —   | —   |  |
| ECLIPSE KNOB  60     | —             | 163 | —   | —   | —   | 205 | 205 | —   | —   |  |
| STANHOPE LEVER  44   | —             | 196 | 196 | 216 | 216 | 196 | 216 | 196 | —   |  |
| COPA LEVER  031     | 163           | 196 | 196 | 216 | 216 | 196 | 216 | 196 | —   |  |
| MONACO LEVER  57   | —             | 196 | 196 | 216 | 216 | 196 | 216 | 196 | —   |  |
| BROMPTON LEVER  55 | —             | 196 | 196 | 216 | 216 | 196 | 216 | 196 | —   |  |
| TOWNE LEVER  72    | 163           | 196 | 196 | 216 | 216 | 196 | 216 | 196 | 192 |  |
| MAXWELL LEVER  77  | 163           | 196 | 196 | 216 | 216 | 196 | 216 | 196 | 192 |  |
| OMNI LEVER  78     | 163           | 196 | 196 | 216 | 216 | 196 | 216 | 196 | 192 |  |
| PLAZA LEVER  82    | 163           | 196 | 196 | 216 | 216 | 196 | 216 | 196 | 192 |  |
| DAYTON LEVER  83   | 163           | 196 | 196 | 216 | 216 | 196 | 216 | 196 | 196 |  |
| CRESCENT LEVER  86 | 163           | 196 | 196 | 216 | 216 | 196 | 216 | 196 | 192 |  |
| AMERICAN LEVER  92 | 163           | 196 | 196 | 216 | 216 | 196 | 216 | 196 | 192 |  |
| TITAN LEVER  96    | 163           | 196 | 196 | 216 | 216 | 196 | 216 | 196 | 192 |  |

Mortise Parts, Trim

# TRIM LOCK PARTS

## Handle Design

---

### CR41-39 Crown

16" x 3-7/32" x 11/16"



3E 476

15 534

---

### TN41-39 Towne

16-3/8" x 2-1/4" x 3/8"

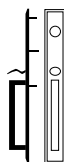

3E 476

15 534

---

Mortise Parts, Trim

# MORTISE DOOR ACCESSORIES

## Recess Stainless Steel Door Pulls

---

TP015



TP046



| MARKS # | PRICE |
|---------|-------|
| TP015   | 32    |
| TP046   | 32    |

# How To ORDER CYLINDRICAL LOCKSETS

## How To Order Example for Cylindrical Locksets

|                              |                              |              |                      |             |                       |
|------------------------------|------------------------------|--------------|----------------------|-------------|-----------------------|
| <b>195</b>                   | <b>N</b>                     | <b>/</b>     | <b>26D</b>           | <b>—</b>    | <b>G3</b>             |
| <i>1.<br/>Lockset Series</i> | <i>2.<br/>Marks Function</i> | <i>Slash</i> | <i>3.<br/>Finish</i> | <i>Dash</i> | <i>4.<br/>Options</i> |

| <b>1</b>              | <b>SERIES</b>  |
|-----------------------|--|
| Cylindrical Locksets: | 110, 110R, 210, 210R, 180, 180R, 280, 280R, 175, 175R, 195, 195R, 295, 295R, 495, 495R |

| <b>2</b>          | <b>CYLINDRICAL FUNCTIONS</b> |                             |          |
|-------------------|------------------------------|-----------------------------|----------|
| MARKS #           | FUNCTION                     | ANSI                        | #        |
| N                 | —                            | PASSAGE                     | F75      |
| L                 | —                            | PRIVACY                     | F76      |
| LK                | —                            | HOSPITAL/PRIVACY            | F76 MOD. |
| P                 | —                            | PATIO                       | F77      |
| DC                | RDC                          | COMMUNICATING               | F80      |
| A                 | RA                           | ENTRY                       | F81      |
| B                 | RB                           | ENTRY                       | F82A     |
| AQ                | —                            | EXIT                        | F83      |
| S                 | RS                           | CLASSROOM                   | F84      |
| F                 | RF                           | STOREROOM                   | F86      |
| DW                | RDW                          | INSTITUTION                 | F87      |
| DA                | RDA                          | VESTIBULE                   | F88      |
| FQ                | —                            | EXIT                        | F89      |
| T                 | RT                           | CORRIDOR                    | F90      |
| TK                | —                            | HOSPITAL/PRIVACY            | F90 MOD. |
| GB                | RGB                          | STORE DOOR (95 SERIES ONLY) | F91      |
| BS                | —                            | SERVICE STATION LOCK        | F92      |
| H                 | —                            | HOTEL                       | F93      |
| AB                | RAB                          | ENTRANCE                    | F109     |
| DB                | RDB                          | CLASSRM. INTRUDER           | F110     |
| NB                | —                            | COMMUNICATING PASSAGE       | F111     |
| FB                | —                            | COMMUNICATING STOREROOM     | F112     |
| SB                | RSB                          | COMMUNICATING CLASSROOM     | F113     |
| FEL               | RFEL                         | ELECTRONICALLY LOCKED       |          |
| FEU               | RFEU                         | ELECTRONICALLY UNLOCKED     |          |
| <b>DUMMY TRIM</b> |                              |                             |          |
| DO                |                              | DUMMY TRIM OUTSIDE          |          |
| DT                |                              | FULL DUMMY                  |          |

| <b>3</b> | <b>FINISH</b> |                              |
|----------|---------------|------------------------------|
| MARKS #  | ANSI #        | FINISH                       |
| US 3     | 605           | Polished Brass, Clear Coated |
| US 4     | 606, 606E     | Satin Brass, Clear Coated    |
| US 10    | 612E          | Satin Bronze, Clear Coated   |
| US 10B   | 613E          | Dark Bronze, Clear Coated    |
| US 26    | 625           | Polished Chrome, Plated      |
| US 26D   | 626           | Satin Chrome, Plated         |
| US 32    | 629           | Polished Stainless Steel     |
| US 32D   | 630           | Satin Stainless Steel        |

| <b>4</b>                                      | <b>OPTIONS</b> |       |           |
|---|----------------|-------|-----------|
| TRIM MODIFICATIONS                            | CODE           | PRICE | PRICE     |
| Tactile knob/lever, coated ext. only          | A1             |       | 60        |
| Tactile knob/lever, knurled                   | A4             |       | 60        |
| Large rose 3-1/8" diameter                    | A8             |       | 11        |
| Tactile knob/lever, coated int. & ext.        | A18            |       | 122       |
| DOOR THICKNESS                                | CODE           | PRICE | PRICE     |
| 2" (50 mm)                                    | D1             |       | NC        |
| 2-1/4" (57mm)                                 | D2             |       | 75        |
| Over 2-3/8" - 4"                              | D9             |       | 648       |
| LATCH   | CODE           | PRICE | PRICE     |
| 2-3/4" backset, 1-1/8" x 2-1/4" face          | E4             |       | NC        |
| 2-3/8" backset, 1" x 2-1/4" face              | E6             |       | NC        |
| 2-3/4" backset, 9/16" throw, Gr. 1, UL Listed | E7             |       | 47        |
| 5" backset, 9/16" throw, Gr. 1                | E9             |       | 47        |
| 3-3/4" backset, 9/16" throw, Gr. 1            | E10            |       | 47        |
| 2-3/8" backset, 1-1/8" x 2-1/4" face          | E11            |       | 12        |
| 2-3/4" backset, 1" x 2-1/4" face              | E12            |       | 12        |
| TRIM CHANGES                                  | CODE           | PRICE | PRICE     |
| Yale conventional                             | F7             |       | 23        |
| Sargent conventional cylinder                 | F8             |       | 23        |
| Corbin conventional cylinder                  | F9             |       | 23        |
| Corbin 6 pin IC core                          | F12            |       | 34        |
| Corbin 7 pin IC core                          | F13            |       | 34        |
| Yale 6 pin IC core                            | F14            |       | 23        |
| Yale 7 pin IC core                            | F15            |       | 23        |
| Schlage 6 pin IC core                         | F19            |       | 23        |
| Sargent IC core                               | F20            |       | 23        |
| Medeco IC core large format                   | F21            |       | 23        |
| CYLINDER                                      | CODE           | PRICE | PRICE     |
| Special optional keyway                       | G2             |       | 37        |
| Less cylinder                                 | G3             |       | Deduct 15 |
| STRIKE  | CODE           | PRICE | PRICE     |
| 4-7/8" ASA strike                             | S1             |       | 13        |
| 2-3/4" "T" strike                             | S3             |       | NC        |

# 80 LINE GRADE 1 CYLINDRICAL KNOBSETS

|                                |               |   |        |   |             |
|--------------------------------|---------------|---|--------|---|-------------|
| <b>BHMA</b><br>CERTIFIED       |               | ANSI-A156.2 • Grade 1<br>3 Hour Fire Rating |        | Series 180/180R • 2-3/4" Backset<br>Series 280/280R • 2-3/4" Backset  |             |
| 80 Series Knobsets Shown Below |               |   |        | Standard Features   |             |
|                                |               |   |        | <ul style="list-style-type: none"> <li>• Backset: 2-3/4"</li> <li>• Latch #1834, Front: 1-1/8" x 2-1/4"</li> <li>• Throw: 9/16"; Stainless steel nose</li> <li>• Knobs: 2-1/4" dia. (180) round; 2-3/16" dia. (280) ball</li> <li>• Roses: Adjustable both sides; Steel reinforced 2-3/4" dia.</li> <li>• Strike: #1135, 4-7/8" ASA curved lip strike</li> <li>• Door thickness: 1-5/8" to 1-7/8"</li> <li>• Cylinder: MARKS "C" keyway, 6 pin w/ 2 keys</li> </ul> |             |
| MARKS #                        |               | FUNCTION                                    | ANSI # | FINISH GROUPS   |             |
| COMM. CYL.                     | IC CORE CYL.* |   |        | 3 ❖, 32D  | 10, 10B, 32 |
| N                              | —             | PASSAGE                                     | F75    | 434   | 473         |
| L                              | —             | PRIVACY                                     | F76    | 438   | 477         |
| P                              | —             | PATIO                                       | F77    | 438   | 477         |
| DC                             | RDC ❖         | COMMUNICATING                               | F80    | 508   | 547         |
| A                              | RA ❖          | ENTRY                                       | F81    | 461   | 500         |
| B                              | RB ❖          | ENTRY                                       | F82A   | 461   | 500         |
| AB                             | RAB ❖         | ENTRY                                       | F109   | 461   | 500         |
| AQ                             | —             | EXIT  | F83    | 449   | 488         |
| S                              | RS ❖          | CLASSROOM                                   | F84    | 461   | 500         |
| F                              | RF ❖          | STOREROOM                                   | F86    | 461   | 500         |
| DW                             | RDW ❖         | INSTITUTION                                 | F87    | 508   | 547         |
| DA                             | RDA ❖         | VESTIBULE                                   | F88    | 508   | 547         |
| FQ                             | —             | EXIT  | F89    | 449   | 488         |
| TK                             | —             | HOSPITAL/PRIVACY MOD.                       | F90    | 473   | 511         |
| BS                             | RBS ❖         | SERVICE STATION LOCK                        | F92    | 474   | 512         |
| DO                             | —             | DUMMY TRIM OUTSIDE                          | —      | 262   | 282         |
| DT                             | —             | FULL DUMMY TRIM                             | —      | 361   | 400         |
| NB                             | —             | COMMUNICATING PASSAGE                       | F111   | 398   | 418         |
| FB                             | RFB ❖         | COMMUNICATING STOREROOM                     | F112   | 457   | 477         |
| SB                             | RSB ❖         | COMMUNICATING CLASSROOM                     | F113   | 457   | 477         |

**KNOBS ARE PACKED 12 PER CASE**

NOTE: Split designs and/or finishes are priced at the highest design and/or finish • Special finishes, consult factory  
 • IC Core Models: Tailpieces included, core not included  
 ❖ IC Core Models in US3 Finish: Add \$42.00 to list price

| OPTIONS                            | CODE | PRICE     |
|------------------------------------|------|-----------|
| For 2" doors                       | D1   | NC        |
| For 2-1/4" doors                   | D2   | 75        |
| 2-3/8" backset, 1" x 2-1/4" face   | E6   | NC        |
| 5" backset, 9/16" throw, Gr. 1     | E9   | 47        |
| 3-3/4" backset, 9/16" throw, Gr. 1 | E10  | 47        |
| Less cylinder                      | G3   | Deduct 15 |
| 2-3/4" "T" strike                  | S3   | NC        |

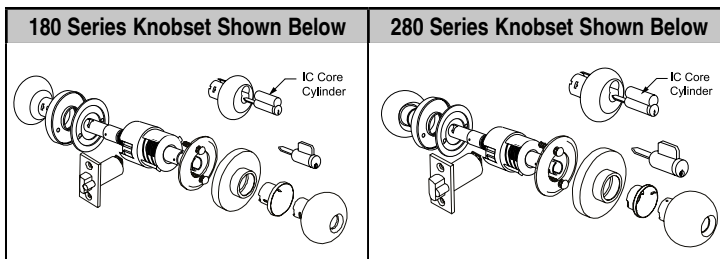



**★Standard & HI-SECURITY™ IC Core Models:**

Interchangeable Core models for 6 or 7 pin cores (not included).

**Accepts:** Marks, Marks HI-SECURITY™, Medeco®, KeyMark™, Falcon, Schlage® small format & Best®. **IC Core Tailpieces ARE Included.**



# 10 LINE GRADE 2 CYLINDRICAL KNOBSETS

|   |               |  |   |   |               |  |
|---|---------------|--|---|---|---------------|--|
| <b>BHMA</b><br>CERTIFIED  |               | ANSI-A156.2 • Grade 2 Plus<br>3 Hour Fire Rating |  | Series 110/110R • 2-3/8" Backset<br>Series 210/210R • 2-3/8" Backset  |               |  |
| 10 Series Knobsets Shown Below  |               |  |   | Standard Features   |               |  |
|   |               |  |   | <ul style="list-style-type: none"> <li>• Backset: 2-3/8"</li> <li>• Latch #1138, Front: 1" x 2-1/4"; Throw: 1/2"; Stainless steel nose</li> <li>• Knobs: 2-1/4" dia. (110) round; 2-3/16" dia. (210) ball</li> <li>• Roses: Adjustable both sides; Steel reinforced 2-3/4" dia.</li> <li>• Strike: #1136, 2-3/4" "T" strike</li> <li>• Door thickness: 1-5/8" to 1-7/8"</li> <li>• Cylinder: MARKS "C" keyway, 6 pin w/ 2 keys</li> </ul> |               |  |
| MARKS #   |               |  | FUNCTION  | ANSI #  | FINISH GROUPS |  |
| COMM. CYL.  | IC CORE CYL.* | 3❖, 32D  |   |   | 10, 10B, 32   |  |
| N   | —             | PASSAGE  | F75   | 147   | 187           |  |
| L   | —             | PRIVACY  | F76   | 176   | 215           |  |
| P   | —             | PATIO  | F77   | 178   | 217           |  |
| DC  | RDC ❖         | COMMUNICATING                                    | F80   | 235   | 275           |  |
| A   | RA ❖          | ENTRY  | F81   | 208   | 247           |  |
| B   | RB ❖          | ENTRY  | F82A  | 208   | 247           |  |
| AB  | RAB ❖         | ENTRY  | F109  | 208   | 247           |  |
| AQ  | —             | EXIT   | F83   | 194   | 233           |  |
| S   | RS ❖          | CLASSROOM  | F84   | 208   | 247           |  |
| F   | RF ❖          | STOREROOM  | F86   | 208   | 247           |  |
| DW  | RDW ❖         | INSTITUTION                                      | F87   | 236   | 276           |  |
| DA  | RDA ❖         | VESTIBULE  | F88   | 236   | 276           |  |
| FQ  | —             | EXIT   | F89   | 194   | 233           |  |
| DO  | —             | DUMMY TRIM OUTSIDE                               | —   | 153   | 173           |  |
| DT  | —             | FULL DUMMY TRIM                                  | —   | 161   | 199           |  |
| NB  | —             | COMMUNICATING PASSAGE                            | F111  | 157   | 177           |  |
| FB  | RFB ❖         | COMMUNICATING STOREROOM                          | F112  | 220   | 244           |  |
| SB  | RSB ❖         | COMMUNICATING CLASSROOM                          | F113  | 220   | 244           |  |

**KNOBS ARE PACKED 12 PER CASE**

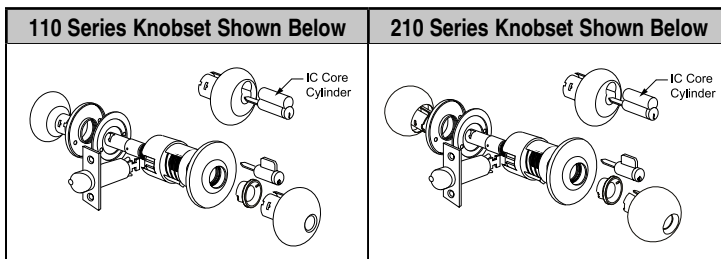

NOTE: Split designs and/or finishes are priced at the highest design and/or finish • Special finishes, consult factory  
 • IC Core Models: Tailpieces included, core not included  
 ❖ IC Core Models in US3 Finish: Add \$42.00 to list price

| OPTIONS                                       | CODE | PRICE     |
|---|------|-----------|
| For 2" doors                                  | D1   | NC        |
| For 2-1/4" doors                              | D2   | 75        |
| 2-3/4" backset, 1-1/8" x 2-1/4" face          | E4   | NC        |
| 2-3/4" backset, 9/16" throw, Gr. 1, UL Listed | E7   | 47        |
| Solid latch for electric strike               | E9   | 47        |
| 3-3/4" backset, 9/16" throw, Gr. 1            | E10  | 47        |
| Less cylinder                                 | G3   | Deduct 15 |
| 4-7/8" ASA strike with curved lip             | S1   | 13        |



★ **Standard & HI-SECURITY™ IC Core Models:**   
 Interchangeable Core models for 6 or 7 pin cores (not included).  
**Accepts:** Marks, Marks HI-SECURITY™, Medeco®, KeyMark™, Falcon, Schlage® small format & Best®. **IC Core Tailpieces ARE Included.**

# 95 LINE GRADE 1 CYLINDRICAL SURVIVOR LEVERSETS

|   |               |   |   |   |  |  |
|---|---------------|---|---|---|--|--|
| <b>BHMA</b><br>CERTIFIED  |               |  | ANSI-A156.2 • Grade 1<br>3 Hour Fire Rating |    | <b>SURVIVOR SERIES</b><br>Series 195/195R, 295/295R, 495/495R • 2-3/4" Backset |  |
| 95 Series Leversets Shown Below   |               |   |   | Standard Features   |  |  |
|  |               |   |   | <ul style="list-style-type: none"> <li>• Backset 2-3/4"</li> <li>• Latch #1834, Front: 1-1/8" x 2-1/4"; Throw: 9/16"; Stainless steel nose</li> <li>• Levers: Solid cast Zamac; w/ 1/2" return (except 395 &amp; 495)</li> <li>• Roses: Thru-bolted, 3-7/16" dia., spring loaded 2-#10 thru-bolts</li> <li>• Strike: #1135, 4-7/8" ASA curved lip strike</li> <li>• Door thickness: 1-5/8" to 1-7/8"; <b>For 1-3/8" door use K1904 spacer</b></li> <li>• Cylinder: MARKS "C" keyway, 6 pin w/ 2 keys</li> </ul> |  |  |
| MARKS #   |               | FUNCTION  | ANSI #                                      | FINISH GROUPS   |  |  |
| COMM. CYL.  | IC CORE CYL.* |   |   | 3, 26D  | 4, 10, 10B, 26   |  |
| N   | —             | PASSAGE   | F75   | 416   | 496  |  |
| L   | —             | PRIVACY   | F76   | 439   | 524  |  |
| LK  | —             | HOSPITAL/PRIVACY  | F76 MOD.                                    | 468   | 551  |  |
| P   | —             | PATIO   | F77   | 434   | 518  |  |
| DC  | RDC           | COMMUNICATING   | F80   | 504   | 585  |  |
| A   | RA            | ENTRY   | F81   | 457   | 541  |  |
| B   | RB            | ENTRY   | F82A  | 457   | 541  |  |
| AB  | RAB           | ENTRY   | F109  | 457   | 541  |  |
| AQ  | —             | EXIT  | F83   | 444   | 529  |  |
| S   | RS            | CLASSROOM   | F84   | 457   | 541  |  |
| F   | RF            | STOREROOM   | F86   | 457   | 541  |  |
| DW  | RDW           | INSTITUTION   | F87   | 504   | 585  |  |
| DA  | RDA           | VESTIBULE   | F88   | 504   | 585  |  |
| FQ  | —             | EXIT  | F89   | 444   | 529  |  |
| T   | RT            | CORRIDOR  | F90   | 468   | 551  |  |
| TK  | —             | HOSPITAL/PRIVACY  | F90 MOD.                                    | 434   | 518  |  |
| GB  | RGB           | STORE DOOR  | F91   | 621   | 678  |  |
| BS  | RBS           | SERVICE STATION LOCK  | F92   | 468   | 551  |  |
| H   | —             | HOTEL   | F93   | 515   | 596  |  |
| DB  | RDB           | CLASSROOM INTRUDER  | F110  | 555   | 640  |  |
| DO  | —             | DUMMY TRIM OUTSIDE  | —   | 258   | 340  |  |
| DT  | —             | FULL DUMMY TRIM   | —   | 369   | 452  |  |
| NB  | —             | COMMUNICATING PASSAGE   | F111  | 392   | 474  |  |
| FB  | RFB           | COMMUNICATING STOREROOM   | F112  | 461   | 534  |  |
| SB  | RSB           | COMMUNICATING CLASSROOM   | F113  | 461   | 534  |  |
| FEL   | RFEL          | ELECTRICALLY LOCKED*  | —   | 668   | 752  |  |
| FEU   | RFEU          | ELECTRICALLY UNLOCKED*  | —   | 668   | 752  |  |

Marks USA Antimicrobial Finish Available - Option Code: AM - Add \$40

LEVERS ARE PACKED 6 PER CASE

NOTE: Split designs and/or finishes are priced at the highest design and/or finish • Special finishes, consult factory

\*ELECTRIFIED FUNCTIONS: 100% Duty Cycle 24V AC/DC, supplied with bridge rectifier : EU - 210 ma; EL - 125 ma

• IC Core Models: Tailpieces included, core not included



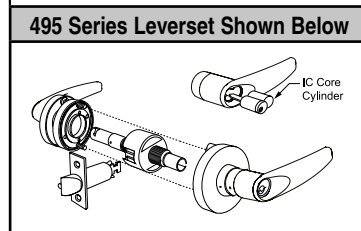
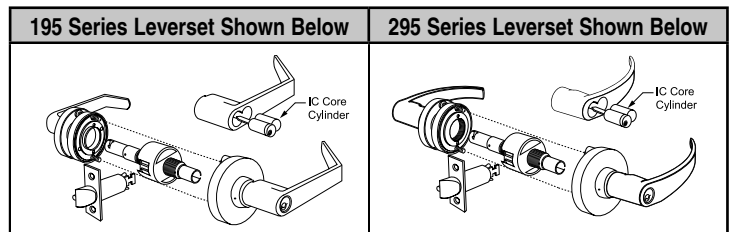

| OPTIONS  | CODE | PRICE - 195 | 295 | 495  |
|--|------|-------------|-----|------|
| For 2" doors                                       | D1   | NC          | NC  | NC   |
| For 2-1/4" doors                                   | D2   | 75          | 75  | Call |
| Over 2-1/4" - 4" thickness                         | D9   | 648         | 648 | 648  |
| 2-3/8" backset, 1" x 2-1/4" face                   | E6   | NC          | NC  | NC   |
| 5" backset, 9/16" throw, Gr. 1                     | E9   | 47          | 47  | 47   |
| 3-3/4" backset, 9/16" throw, Gr. 1                 | E10  | 47          | 47  | 47   |
| Less cylinder                                      | G3   | Deduct 15   | -15 | -15  |
| 2-3/4" "T" strike                                  | S3   | NC          | NC  | NC   |
| <b>AMERICAN LEVER ONLY Accepts:</b>                |      |             |     |      |
| Yale conventional cylinder                         | F7   | 23          | 23  | —    |
| Sargent conventional cylinder                      | F8   | 23          | 23  | —    |
| Corbin conventional cylinder                       | F9   | 23          | 23  | —    |
| Corbin 6 pin IC core                               | F12  | 34          | 34  | —    |
| Corbin 7 pin IC core                               | F13  | 34          | —   | —    |
| Yale 6 pin IC core                                 | F14  | 23          | 23  | —    |
| Yale 7 pin IC core                                 | F15  | 23          | —   | —    |
| Schlage 6 pin IC core                              | F19  | 23          | 23  | —    |
| Sargent IC core                                    | F20  | 23          | 23  | —    |
| <b>AMERICAN &amp; CRESCENT LEVER ONLY Accepts:</b> |      |             |     |      |
| Medeco IC core large format                        | F21  | 23          | 23  | —    |



★ **Standard & HI-SECURITY™ IC Core Models:** Interchangeable Core models for 6 or 7 pin cores (not included). **Accepts:** Marks, Marks HI-SECURITY™, Medeco®, KeyMark™, Falcon, Schlage® small format & Best®. **IC Core Tailpieces ARE Included.**



# 75 LINE GRADE 2 CYLINDRICAL SURVIVOR LEVERSETS

|   |   |  |   |  |          |                   |
|---|---|--|---|--|----------|-------------------|
|  |  | ANSI-A156.2 • Grade 2 Plus<br>3 Hour Fire Rating |  | <b>SURVIVOR SERIES</b><br>Series 175/175R, 275/275R, 475/475R • 2-3/4" Backset   |          |                   |
| 75 Series Leverset Shown Below  |   |  |   | Standard Features  |          |                   |
|  |   |  |   | <ul style="list-style-type: none"> <li>• Backset: 2-3/4"</li> <li>• Latch #1134, Front: 1-1/8" x 2-1/4"; Throw: 1/2"; Stainless steel nose</li> <li>• Levers: Solid cast Zamac; w/ 1/2" return (except 475)</li> <li>• Roses: Thru-bolted, 3-1/4" dia., spring loaded 2-#10 thru-bolts</li> <li>• Strike: #1145, ASA strike</li> <li>• Door thickness: 1-5/8" to 1-7/8"; <i>For 1-3/8" door use K1904 spacer</i></li> <li>• Cylinder: MARKS "C" keyway, 6 pin w/ 2 keys</li> </ul> |          |                   |
| MARKS #   |   | FUNCTION   | ANSI #  | 175  | 275, 475 | 175, 275, 475     |
| COMM. CYL.  | IC CORE CYL.*   |  |   | 26D  | 26D      | 3, 4, 10, 10B, 26 |
| N   | —   | PASSAGE  | F75   | 194  | 211      | 231               |
| L   | —   | PRIVACY  | F76   | 234  | 251      | 271               |
| P   | —   | PATIO  | F77   | 209  | 226      | 246               |
| DC  | RDC   | COMMUNICATING                                    | F80   | 277  | 294      | 314               |
| A   | RA  | ENTRY  | F81   | 234  | 251      | 271               |
| B   | RB  | ENTRY  | F82A  | 234  | 251      | 271               |
| AB  | RAB   | ENTRY  | F109  | 234  | 251      | 271               |
| AQ  | —   | EXIT   | F83   | 224  | 241      | 271               |
| S   | RS  | CLASSROOM  | F84   | 234  | 251      | 271               |
| F   | RF  | STOREROOM  | F86   | 234  | 251      | 271               |
| DW  | RDW   | INSTITUTION                                      | F87   | 281  | 300      | 320               |
| DA  | RDA   | VESTIBULE  | F88   | 283  | 300      | 320               |
| FQ  | —   | EXIT   | F89   | 224  | 241      | 271               |
| T   | RT  | CORRIDOR   | F90   | 245  | 262      | 282               |
| BS  | RBS   | SERVICE STATION LOCK                             | F92   | 245  | 262      | 282               |
| H   | —   | HOTEL  | F93   | 296  | 313      | 333               |
| DO  | —   | DUMMY TRIM OUTSIDE                               | —   | 80   | 96       | 117               |
| DT  | —   | FULL DUMMY TRIM                                  | —   | 162  | 179      | 199               |
| NB  | —   | COMMUNICATING PASSAGE                            | F111  | 170  | 184      | 195               |
| FB  | RFB   | COMMUNICATING STOREROOM                          | F112  | 246  | 254      | 265               |
| SB  | RSB   | COMMUNICATING CLASSROOM                          | F113  | 246  | 254      | 265               |

| OPTIONS  | CODE | PRICE - 175 | 275 | 475 |
|--|------|-------------|-----|-----|
| 2-3/8" backset, 1" x 2-1/4" face                   | E6   | NC          | NC  | NC  |
| 2-3/4" backset, 9/16" throw, Gr. 1, UL Listed      | E7   | 47          | 47  | 47  |
| 5" backset, 9/16" throw, Gr. 1                     | E9   | 47          | 47  | 47  |
| 3-3/4" backset, 9/16" throw, Gr. 1                 | E10  | 47          | 47  | 47  |
| Less cylinder                                      | G3   | Deduct 15   | -15 | -15 |
| 2-3/4" T strike                                    | S3   | NC          | NC  | NC  |
| <b>AMERICAN LEVER ONLY Accepts:</b>                |      |             |     |     |
| Yale conventional cylinde                          | F7   | 23          | 23  | —   |
| Sargent conventional cylinder                      | F8   | 23          | 23  | —   |
| Corbin conventional cylinder                       | F9   | 23          | 23  | —   |
| Corbin 6 pin IC core                               | F12  | 34          | 34  | —   |
| Corbin 7 pin IC core                               | F13  | 34          | —   | —   |
| Yale 6 pin IC core                                 | F14  | 23          | 23  | —   |
| Yale 7 pin IC core                                 | F15  | 23          | 23  | —   |
| Schlage 6 pin IC core                              | F19  | 23          | 23  | —   |
| Sargent IC core                                    | F20  | 23          | 23  | —   |
| <b>AMERICAN &amp; CRESCENT LEVER ONLY Accepts:</b> |      |             |     |     |
| Medeco IC core large format                        | F21  | 23          | 23  | —   |

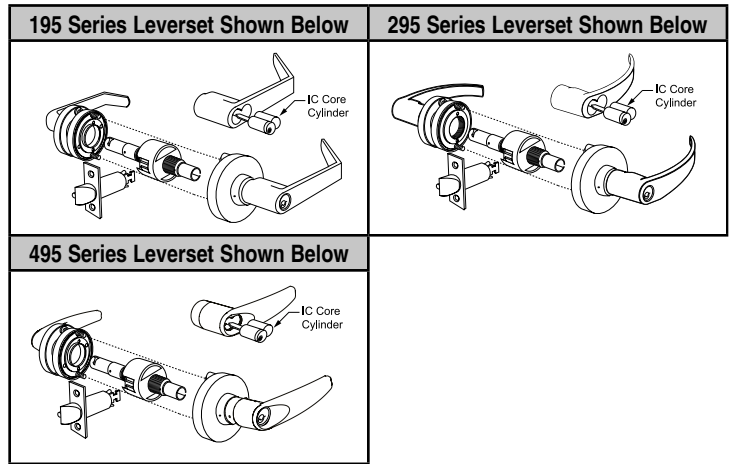

★ **Standard & HI-SECURITY™ IC Core Models:** Interchangeable Core models for 6 or 7 pin cores (not included). **Accepts:** Marks, Marks HI-SECURITY™, Medeco®, KeyMark™, Falcon, Schlage® small format & Best®. **IC Core Tailpieces ARE Included.**

# CYLINDRICAL LOCK ACCESSORIES

## Latches, Strikes, Etc.

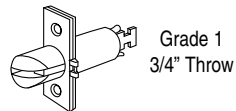
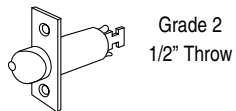

| LATCH   | THROW | Backset: 2-3/8"<br>Front: 1" x 2-1/4" | Backset: 2-3/4"<br>Front: 1-1/8" x 2-1/4" | FUNCTION | FINISH GROUPS |        |         |
|---------|-------|---------------------------------------|---|----------|---------------|--------|---------|
|         |       |                                       |   |          | 26D           | 3, 32D | 10, 10B |
| GRADE 2 | 1/2"  | 1138A                                 | 1134A                                     | ENTRANCE | —             | 44     | 53      |
|         |       | 1138L                                 | 1134L                                     | PRIVACY  | —             | 32     | 44      |
|         |       | 1138N                                 | 1134N                                     | PASSAGE  | —             | 32     | 44      |
|         |       | 1138P                                 | 1134P                                     | PATIO    | —             | 44     | 53      |
| GRADE 1 | 9/16" | —                                     | 1834A                                     | ENTRANCE | —             | 89     | 97      |
|         |       | —                                     | 1834L                                     | PRIVACY  | —             | 75     | 89      |
|         |       | —                                     | 1834N                                     | PASSAGE  | —             | 75     | 89      |
|         |       | —                                     | 1834P                                     | PATIO    | —             | 75     | 89      |

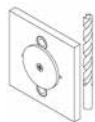
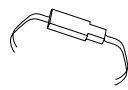
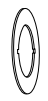
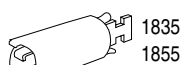
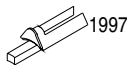

| PART   | #      | DESCRIPTION                                | FINISH GROUPS |         |
|--|--------|--|---------------|---------|
|  |        |  | 3, 32D        | 10, 10B |
| STRIKES  | 1135   | 4-7/8" ASA strike, curved lip              | 22            | 22      |
|  | P1136  | 2-3/4" "T" strike w/dust box, curved lip   | 13            | 21      |
|  | 1136-M | 2-3/4" "T" strike w/dust box, straight lip | 14            | 22      |
| SURVIVOR SERIES ALUMINUM SPACER RINGS                                  | K1904  | For 1-3/8" door (2 per set), 3-7/16" dia.  | 39            | 49      |
| KNOB SPACER RINGS  | K2804  | For 1-3/8" door (2 per set), 2-3/4" dia.   | 39            | 50      |
| PART   | #      | DESCRIPTION                                | NO FINISH     |         |
| EXTENSION LINK<br><i>For use with 2-3/4"<br/>Grade 1 backset latch</i> | 1835   | 3-3/4"                                     | 32            |         |
|  | 1855   | 5"   |               |         |
|  | 1855-P | 5" (Grade 1; L, P functions only)          |               |         |
| BRIDGE RECTIFIER   | 1901   | Bridge rectifier 24 V AC/DC (no finish)    | 49            |         |
| CYLINDER RETAINER  | 1997   | Lever handle cylinder retainer             | 5             |         |
| INSTALLATION TOOL  | J295   | 175/195 installation drill jig             | 186           |         |

# CYLINDRICAL LOCK ACCESSORIES

## Cylinders

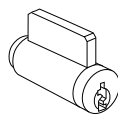

Conventional Cylinder

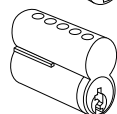

IC Core Cylinder  
(Will Fit Best® Housings)

**FOR KEYS & KEYING, SEE PAGE 76**

| PART #  | DESCRIPTION                   | PRICE |
|---------|-------------------------------|-------|
| 1982    | 6 Pin, w/2 nickel-silver keys | 34    |
| 1982H   | 6 Pin, w/2 nickel-silver keys | 76    |
| R1182   | 6 Pin core, uncombined        | 43    |
| *R1183  | 7 Pin core, uncombined        | 43    |
| *RA1182 | 6 Pin core, combined          | 63    |
| *RA1183 | 7 Pin core, combined          | 63    |
| *RC1182 | 6 Pin core, construction core | 45    |
| *RC1187 | Plastic core turnknob         | 7     |

Specify Tailpiece; *Tailpiece Not Included.*

IC core pricing includes KA, KD or MK Keying.

\* Consult Factory on pricing of IC Cores when ordered with Locksets.

## Cylindrical Lock Tailpieces

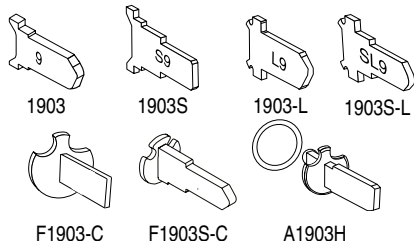

| PART #   | CODE | FUNCTION                          | CYLINDER  | PRICE |
|----------|------|-----------------------------------|---|-------|
| 1903     | 9    | AB, B, DA (ext.), DW, F, FEL, FEU | MARKS 1982  | 6     |
| 1903S    | S9   | S, DA (int.), DB, DC, SB, T       |   |       |
| 1903-L   | L9   | AB, B, DA (ext.), DW, F, FEL, FEU | Arrow PK 100C, Ilco 705, Lori 1539, Sargent 13-3266, Abloy, ASSA 65673, 65691 | 6     |
| 1903S-L  | SL9  | S, DA (int.), DB, DC, SB, T       |   |       |
| F1903-C  | —    | AB, B, DA (ext.), DW, F, FEL, FEU | Schlage 23-001, Primus, Corbin-Russwin 2000-034                               | 8     |
| F1903S-C | —    | S, DA (int.), DB, DC, SB, T       |   |       |

## Cylindrical IC Core Tailpieces

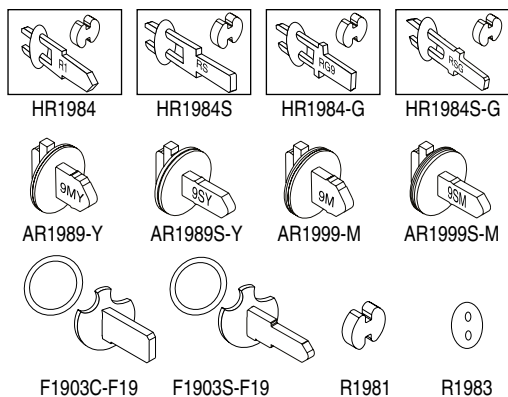

| PART #     | CODE | FUNCTION                          | CORE   | PRICE |
|------------|------|-----------------------------------|--|-------|
| HR1984     | R1   | AB, B, DA (ext.), DW, F, FEU, FEL | 6 or 7 pin Marks, KSP, Best®, Falcon, Medeco®, Keymark®, Sargent®, Schlage® Small Format | 6     |
| HR1984S    | RS   | S, DA (int.), DB, DC, SB, T       |  |       |
| HR1984-G   | RG9  | AB, B, DA (ext.), DW, F, FEU, FEL | 6 or 7 pin Corbin  | 6     |
| HR1984S-G  | RSG  | S, DA (int.), DB, DC, SB, T       |  |       |
| AR1989-Y   | 9MY  | AB, B, DA (ext.), DW, F, FEU, FEL | 6 or 7 pin Yale  | 8     |
| AR1989S-Y  | 9SY  | S, DA (int.), DB, DC, SB, T       |  |       |
| AR1999-M   | 9M   | AB, B, DA (ext.), DW, F, FEU, FEL | Medeco®  | 8     |
| AR1999S-M  | 9SM  | S, DA (int.), DB, DC, SB, T       | Medeco®  | 8     |
| F1903C-F19 | —    | AB, DW, F                         | 6 pin Schlage® Large Format  | 8     |
| F1903S-F19 | —    | S, DA, DB, DC, SB, T              |  |       |
| R1981      |      | Spacer                            |  | 6     |
| R1983      |      | Security Disc                     |  | 6     |

For Keying information see Pages 76-77

### How To Order Example for Cylindrical Lock Cylinders & Tailpieces

|                |       |              |      |               |
|----------------|-------|--------------|------|---------------|
| <b>1982</b>    | /     | <b>26D</b>   | —    | <b>9</b>      |
| 1.<br>Cylinder | Slash | 2.<br>Finish | Dash | 3.<br>Options |

See list of cylinders available.

- |                              |                              |                                  |
|------------------------------|------------------------------|----------------------------------|
| <input type="checkbox"/> 3   | <input type="checkbox"/> 26  | <input type="checkbox"/> Special |
| <input type="checkbox"/> 4   | <input type="checkbox"/> 26D | _____                            |
| <input type="checkbox"/> 10  | <input type="checkbox"/> 32  |                                  |
| <input type="checkbox"/> 10B | <input type="checkbox"/> 32D |                                  |

Tailpiece & keying information must be included in the option section.

# CYLINDRICAL KNOB/LEVER FUNCTIONS

| ANSI# CODE | MARKS FUNCTION |
|------------|----------------|
| F75        | .N             |
| F76        | .L             |
| F76 (MOD.) | .LK            |
| F77        | .P             |
| F80        | .DC            |
| F81        | .A             |

| ANSI# CODE | MARKS FUNCTION |
|------------|----------------|
| F82A       | .B             |
| F83        | .AQ            |
| F84        | .S             |
| F86        | .F             |
| F87        | .DW            |
| F88        | .DA            |

| ANSI# CODE                    | MARKS FUNCTION |
|-------------------------------|----------------|
| F89                           | .FQ            |
| F90                           | .T             |
| F90 (MOD.)                    | .TK            |
| F91 (95 Series Leverset ONLY) | GB             |
| F92                           | .BS            |
| F93                           | .H             |

| ANSI# CODE | MARKS FUNCTION |
|------------|----------------|
| F109       | .AB            |
| F110       | .DB            |
| F111       | .NB            |
| F112       | .FB            |
| F113       | .SB            |

| ANSI # CODE   | Marks Function |     |
|---|----------------|-----|
|   | I/S            | O/S |
| <b>F75 PASSAGE:</b><br>Latch by knob/lever either side.   |                | N   |
| <b>F76 PRIVACY:</b><br>Latch by knob/lever either side unless outside knob/lever locked by push-button from inside. Outside unlocks by turning inside knob/lever, outside emergency turn or closing door.   |                | L   |
| <b>F76 (MOD.) HOSPITAL/PRIVACY:</b><br>Latch by knob/lever either side unless outside knob/lever locked by push-button from inside. Outside unlocks by turning inside knob/lever, outside turn or closing door. Emergency turn-knob A5 option.                            |                | LK  |
| <b>F77 PATIO:</b><br>Deadlocking latch by knob/lever either side unless outside knob/lever locked by push-button inside. Unlocks by turning inside knob/lever or closing door.  |                | P   |
| <b>F80 COMMUNICATING:</b><br>Key both sides. Locks or unlocks either knob/lever independent of the other. Deadlocking latch.  |                | DC  |
| <b>F81 ENTRY:</b><br>Deadlocking latch bolt by knob/lever either side except when outside locked by turn-button inside. When outside locked, key outside or knob/lever inside opens lock. Turn-button operated manually.  |                | A   |
| <b>F82A ENTRY:</b><br>Deadlocking latch by knob/lever either side. Outside locked by push-button inside. When outside locked by push-button inside, key opens lock, unlocks push-button. Inside knob/lever always opens latch. Closing door does not release push-button. |                | B   |
| <b>F83 EXIT:</b><br>Deadlocking latch by knob/lever either side except when outside locked by turn-button inside. Inside knob/lever always opens latch. Turn-button operated manually.  |                | AQ  |
| <b>F84 CLASSROOM:</b><br>Deadlocking latch by knob/lever inside. Outside knob/lever locked or unlocked by key.  |                | S   |
| <b>F86 STOREROOM:</b><br>Deadlocking latch by knob/lever inside, key outside. Outside knob/lever always locked.   |                | F   |
| <b>F87 INSTITUTION:</b><br>Both knob/levers always locked. Deadlocking latch by key both sides.   |                | DW  |
| <b>F88 VESTIBULE:</b><br>Deadlocking latch by knob/lever either side, except when outside knob/lever locked by key inside. Key outside retracts deadlocking latch. Inside always open.  |                | DA  |
| <b>F89 EXIT:</b><br>Deadlocking latch by knob/lever inside. Outside always locked.  |                | FQ  |
| <b>F90 CORRIDOR:</b><br>Deadlocking latch by knob/lever either side unless outside locked by key or inside push-button. Unlock by key, turning inside knob/lever or closing door.   |                | T   |

| ANSI # CODE   | Marks Function |     |
|---|----------------|-----|
|   | I/S            | O/S |
| <b>F90 (MOD.) HOSPITAL/PRIVACY:</b><br>Deadlocking latch by knob/lever either side unless outside locked by knob/lever or inside push-button. Unlock by turn-knob, turning inside knob/lever or closing door. Emergency turn-knob A5 option.  |                | TK  |
| <b>F91 STORE DOOR (95 Series Leverset ONLY):</b><br>Deadlocking latch by knob/lever either side except when both knob/levers are locked by key from either side.  |                | GB  |
| <b>F92 SERVICE STATION LOCK:</b><br>Deadlocking latch by knob/lever either side unless outside locked by key or inside push-button. Unlock by key, turning inside knob/lever or closing door, except when slotted push-button is turned in locked position. Inside knob/lever always opens latch. |                | BS  |
| <b>F93 HOTEL:</b><br>Deadlocking latch by knob/lever inside. Outside knob/lever always locked. Inside push-button projects indicator on cylinder face shutting out all keys except emergency key. Turning inside knob/lever or closing door releases push-button.                                 |                | H   |
| <b>F109 ENTRY:</b><br>Outside locked by pushing turn-button inside. Key outside opens lock. Rotating inside knob/lever releases button and outside knob/lever. By pushing and turning inside button, outside knob/lever remains locked. Deadlocking latch.  |                | AB  |
| <b>F110 CLASSROOM INTRUDER:</b><br>Deadlocking latch by knob/lever either side, except when outside locked by key inside. Key outside locks or unlocks outside. Inside always open  |                | DB  |
| <b>DUMMY TRIM:</b><br>Outside only, rigid.  |                | DO  |
| <b>DUMMY TRIM:</b><br>Both sides, rigid.  |                | DT  |
| <b>F111 COMMUNICATING PASSAGE:</b><br>Blank outside. Deadlocking latch by knob/lever inside.  |                | NB  |
| <b>F112 COMMUNICATING STOREROOM:</b><br>Blank outside. Deadlocking latch by key only. Knob/lever always locked.   |                | FB  |
| <b>F113 COMMUNICATING CLASSROOM:</b><br>Blank outside. Inside knob/lever locked or unlocked by key. Deadlocking latch.  |                | SB  |
| <b>ELECTRICALLY LOCKED - FEL (Fail Safe):</b><br>Outside always locked electrically. Open by key outside, switch or loss of power. Deadlocking latch by lever inside. <b>Lever only.</b>  |                | FEL |
| <b>ELECTRICALLY UNLOCKED - FEU (Fail Secure):</b><br>Outside always locked until unlocked by key or electrically energized. Deadlocking latch by lever inside. <b>Lever only.</b>   |                | FEU |

Cylindrical Locksets

# How To Order Tubular Locksets

## How To Order Example for Tubular Locksets

|                          |                       |                      |                          |              |                  |             |                   |
|--------------------------|-----------------------|----------------------|--------------------------|--------------|------------------|-------------|-------------------|
| <b>1</b>                 | <b>RW</b>             | <b>92</b>            | <b>N</b>                 | <b>/</b>     | <b>32D</b>       | <b>—</b>    | <b>S3</b>         |
| <i>1. Lockset Series</i> | <i>2. Rose Design</i> | <i>3. Knob/Lever</i> | <i>4. Marks Function</i> | <i>Slash</i> | <i>5. Finish</i> | <i>Dash</i> | <i>6. Options</i> |

| 1 SERIES              |   |
|-----------------------|---|
| Tubular Locksets      | 1 |
| Cylindrical Cartridge | 1 |

| 2 ROSES |                                   |        |
|---------|-----------------------------------|--------|
| ROSES   |                                   | DESIGN |
| 9602-R  | Rose with ring 2-9/16" dia.       | RR     |
| 9602    | Plain rose 2-9/16" dia.           | RW     |
| 5602-R  | Small rose with ring 2-1/4" dia.  | RQ     |
| 5602    | Small rose 2-1/4" dia.            | RS     |
| 7602    | Square rose 2-9/16" square        | RX     |
| 7607    | Square forged rose 2-9/16" square | RK     |

| 3 KNOB/LEVER |                 |        |
|--------------|-----------------|--------|
| KNOBS        |                 | DESIGN |
| 1153         | Round, wrought  | 10     |
| 1253         | Ball, wrought   | 20     |
| 9631         | Ball, forged    | 30     |
| 9609         | Eclipse, forged | 60     |
| LEVERS       |                 | DESIGN |
| SF031        | Copa            | 031    |
| 5642         | Palace          | 42     |
| 5657         | Monaco          | 57     |
| 5662         | Royale          | 62     |
| 5672         | Towne           | 72     |
| 5677         | Maxwell         | 77     |
| 5678         | Omni            | 78     |
| 5682         | Plaza           | 82     |
| 5683         | Dayton          | 83     |
| 5686         | Crescent        | 86     |
| 5692         | American        | 92     |
| 5696         | Titan           | 96     |



| 4 TUBULAR FUNCTIONS     |                    |        |
|-------------------------|--------------------|--------|
| MARKS #                 |                    | ANSI # |
| <b>TUBULAR LOCKSETS</b> |                    |        |
| N                       | PASSAGE            | F75    |
| L                       | PRIVACY            | F76    |
| NB                      | COMMUNICATING      | F111   |
| DI                      | DUMMY TRIM INSIDE  |        |
| DO                      | DUMMY TRIM OUTSIDE |        |
| DT                      | FULL DUMMY         |        |



| 5 FINISH |                              |           |
|----------|------------------------------|-----------|
| MARKS    |                              | ANSI #    |
| US 3     | Polished Brass, Clear Coated | 605       |
| US 3E    | Polished Brass "PVD"         | 605E      |
| US 4     | Satin Brass, Clear Coated    | 606, 606E |
| US10     | Satin Bronze, Clear Coated   | 612E      |
| US 10B   | Dark Bronze, Clear Coated    | 613E      |
| US15     | Satin Nickel                 | 619, 619E |
| US 26    | Polished Chrome, Plated      | 625       |
| US 26D   | Satin Chrome, Plated         | 626       |
| US 32    | Polished Stainless Steel     | 629       |
| US 32D   | Satin Stainless Steel        | 630       |

| 6 OPTIONS  |      |       |
|--|------|-------|
| TRIM MODIFICATIONS   | CODE | PRICE |
| Tactile knob/lever, coated ext. only   | A1   | 60    |
| Tactile knob/lever, knurled  | A4   | 60    |
| Tactile knob/lever, coated int. & ext.   | A18  | 122   |
| DOOR THICKNESS   | CODE | PRICE |
| 1-3/4"   | D4   | NC    |
| 1-3/8"   | D5   | NC    |
| LATCH  | CODE | PRICE |
| 2-3/4" backset, 1-1/8" x 2-1/4" face   | E4   | 10    |
| <b>2-3/4" backset, 9/16" throw, Gr. 1, UL Listed With Cylindrical Cartridge*</b> |      |       |
| 2-3/8" backset, 1-1/8" x 2-1/4" face   | E7   | 107   |
| 2-3/4" backset, 1-1/8" x 2-1/4" face   | E11  | 13    |
| 2-3/4" backset, 1 x 2-1/4" face  | E12  | 13    |
| Adjustable latch 1-1/8" x 2-1/4" face  | E13  | 10    |
| TRIM CHANGES   | CODE | PRICE |
| For 1-1/2" bore  | F6   | 17    |
| STRIKE   | CODE | PRICE |
| 4-7/8" ASA strike  | S1   | 13    |
| 2-3/4" "T" strike  | S3   | NC    |
| 3-5/8" Security strike   | S4   | 11    |
| 2-1/4" Curved lip strike   | S5   | NC    |

\* E7 Option Available: 2-3/8", 2-3/4", 3-3/4" & 5" Backset, for N Function ONLY.

# TUBULAR KNOB/LEVER FUNCTIONS

| ANSI # CODE   |         | MARKS FUNCTION   |
|---|---------|--|
| <b>F75 PASSAGE:</b><br>Latch by knob/lever either side.   | I/S O/S |  N  |
| <b>F76 PRIVACY:</b><br>Latch by knob/lever either side unless outside knob/lever locked by push-button from inside. Outside unlocks by turning inside knob/lever, outside emergency turn or closing door. |         |  L  |
| <b>F111 COMMUNICATING:</b><br>Blank outside. Deadlocking latch by knob/lever inside.  |         |  NB |

| ANSI # CODE  |         | MARKS FUNCTION   |
|--|---------|--|
| <b>DUMMY TRIM INSIDE:</b><br>Dummy trim inside ONLY.   | I/S O/S |  DI |
| <b>DUMMY TRIM OUTSIDE:</b><br>Dummy trim outside ONLY. |         |  DO |
| <b>FULL DUMMY TRIM:</b><br>Dummy trim both sides.      |         |  DT |



# ROSE DESIGN RR, RW, RQ, RS, RX\*, RK\*, RL\*

Tubular Locksets

| ANSI-A156 • Grade 2  |   |        | Series 1 • 2-3/8" Backset |        |         |  |                         |                       |
|--|---|--------|---------------------------|--------|---------|--|-------------------------|-----------------------|
| Standard Features  |   |        | KNOBS                     |        |         | LEVERS   |                         |                       |
|  | <ul style="list-style-type: none"> <li>• Backset: 2-3/8", 2-3/4" optional</li> <li>• Front: 1" x 2-1/4"</li> <li>• Thru-bolted screwless knob/lever rose</li> <li>• Concealed mounting screws</li> <li>• Lever support springs</li> <li>• Independent spring loaded captivated spindles</li> <li>• Strike: 2-1/4" full curved lip</li> <li>• Latch support housing</li> <li>• Door thickness: 1-3/8" to 1-3/4"</li> <li>• Privacy function - interior with automatic release</li> </ul> |        | 10, 20                    | 30, 60 |         | 031, 44, 55,<br>57, 72, 77,<br>78, 82, 83,<br>86, 92, 96 |                         | 82, 83, 86,<br>92, 96 |
|  | FINISH GROUPS   |        |                           |        |         |  |                         |                       |
| MARKS #  | FUNCTION  | ANSI # | 3, 32D                    | 3E, 15 | 10B, 26 | 3F, 4, 15,<br>26D  | 10E, 10B,<br>19E 14, 26 | 32, 32D               |
| <b>KEYLESS</b>   |   |        |                           |        |         |  |                         |                       |
| N  | PASSAGE   | F75    | 235                       | 300    | 337     | 316  | 353                     | 304                   |
| L  | PRIVACY   | F76    | 246                       | 311    | 348     | 326  | 364                     | 315                   |
| NB   | COMMUNICATING   | F111   | 288                       | 288    | 326     | 305  | 342                     | 294                   |
| <b>DUMMY TRIM</b>  |   |        |                           |        |         |  |                         |                       |
| DI   | DUMMY TRIM INSIDE   |        | 110                       | 142    | 212     | 151  | 169                     | 144                   |
| DO   | DUMMY TRIM OUTSIDE  |        |                           |        |         |  |                         |                       |
| DT   | FULLY DUMMY   |        | 219                       | 284    | 321     | 300  | 337                     | 288                   |
| <b>KNOBS &amp; LEVERS ARE PACKED 16 PER CASE</b>   |   |        |                           |        |         |  |                         |                       |
| NOTE: Split designs and/or finishes are priced at the highest design and/or finish • Special finishes, consult factory<br>*Square Rose RX: Add \$30 / *Square Rose RK: Add \$100 |   |        |                           |        |         |  |                         |                       |

| KNOBS  | Round Knob 10                      | Ball Knob 20      | Ball Knob 30      | Eclipse Knob 60                    | ROSES             | RR: 2-9/16" dia. |                  |
|--------|------------------------------------|-------------------|-------------------|------------------------------------|-------------------|------------------|------------------|
|        |                                    |                   |                   |                                    |                   |                  | RW: 2-9/16" dia. |
| LEVERS | Stanhope Lever 44                  | Copa Lever 031    | Brompton Lever 55 | Monaco Lever 57<br>Specify handing |                   |                  | RQ: 2-1/4" dia.  |
|        |                                    |                   |                   |                                    |                   |                  | RS: 2-1/4" dia.  |
|        | Towne Lever 72                     | Maxwell Lever 77  | Omni Lever 78     | Plaza Lever 82<br>Specify handing  |                   |                  | RX: 2-1/2" sq.   |
|        |                                    |                   |                   |                                    |                   |                  | RK: 2-1/2" sq.   |
|        | Dayton Lever 83<br>Specify handing | Crescent Lever 86 | American Lever 92 | Titan Lever 96                     |                   | RL: 1-1/2" sq.   |                  |
|        |                                    |                   |                   |                                    | Wrought<br>Forged |                  |                  |

| OPTIONS   | CODE | PRICE | NOTE            |
|---|------|-------|-----------------|
| 1-3/8" door thickness   | D5   | NC    |                 |
| 2-3/4" backset, 1-1/8" x 2-1/4" face  | E4   | 10    |                 |
| <b>2-3/4" backset, 9/16" throw, Gr. 1, UL Listed WITH CYLINDRICAL CARTRIDGE *</b> | E7   | 107   | N Function Only |
| 2-3/8" backset, 1-1/8" x 2-1/4" face  | E11  | 13    |                 |
| 2-3/4" backset, 1" x 2-1/4" face  | E12  | 13    |                 |
| 4-7/8" ASA strike   | S1   | 13    |                 |
| 2-3/4" "T" strike   | S3   | NC    |                 |
| US 26 Interior  | x26  | 24    | 83, 92, 96 Only |

\* E7 Option Available: 2-3/8", 2-3/4", 3-3/4" & 5" Backset, for N Function ONLY.



# INTERIOR TUBULAR LOCKSETS

Tubular Locksets



## NEW! 60 Series, Stainless Steel, Commercial Locksets

### Standard Features

- Latch Face: 1" x 2-1/4" standard
- Backset: 2-3/4" with 2-3/4" T-strike with square corners
- Door thickness: 1-3/8" to 1-3/4"
- Roses: 2-9/16" diameter
- Backset: 2-3/8" with 2-1/4", radius corner full lip strike, option E6, N/C
- Privacy Function with kick-off latch

| MARKS # | FUNCTION           | ANSI # | FINISH GROUPS (160, 260 & 360) |            |
|---------|--------------------|--------|--------------------------------|------------|
|         |                    |        |                                |            |
|         |                    |        |                                | <b>32D</b> |
| N       | PASSAGE            | F75    |                                | <b>140</b> |
| L       | PRIVACY            | F76    |                                | <b>150</b> |
| DO      | DUMMY TRIM OUTSIDE | —      |                                | <b>70</b>  |

**LEVERS ARE PACKED 9 PER CASE** Additional finishes, consult factory

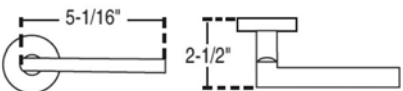
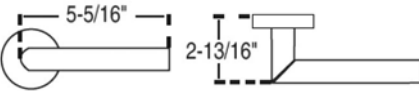
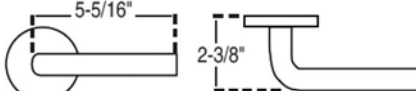
| 160 Series<br>Finishes: 32D   | 260 Series<br>Finishes: 32D  | 360 Series<br>Finishes: 32D   |
|---|--|---|
|  |  |  |
|  |  |  |

## 50 Series, Residential Leversets

### Standard Features

- Pressure cast Levers
- Roses: 2-15/16" diameter
- Adjustable Backset: 2-3/8" - 2-3/4"
- Latch: 1" x 2-1/4" front, 1/2" throw
- Door thickness: 1-3/8" to 1-3/4"
- Privacy Function with kick-off latch
- Strike: 2-1/4" full lip strike
- NOTE: Latches & strikes have radius corners**

| MARKS # | FUNCTION           | ANSI # | FINISH GROUPS (150, 250 & 450) |            |
|---------|--------------------|--------|--------------------------------|------------|
|         |                    |        |                                |            |
|         |                    |        |                                | <b>26D</b> |
| N       | PASSAGE            | F75    |                                | <b>66</b>  |
| L       | PRIVACY            | F76    |                                | <b>78</b>  |
| DO      | DUMMY TRIM OUTSIDE | —      |                                | <b>34</b>  |

**LEVERS ARE PACKED 24 PER CASE** Additional finishes, consult factory

| 150 Series American Lever<br>Finishes: 26D  | 250 Series Crescent Lever<br>Finishes: 26D  | 450 Series Titan Lever<br>Finishes: 26D   |
|---|---|---|
|  |  |  |
|  |  |  |

# TUBULAR LOCKSET ACCESSORIES

## Strikes, Latches, Support Housing

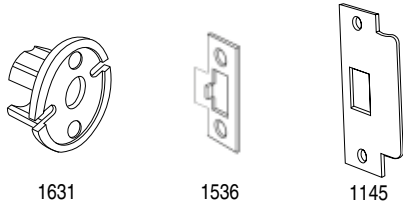

1631

1536

1145

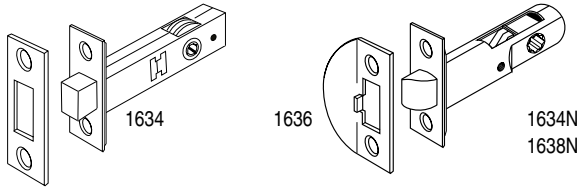

1634

1636

1634N

1638N

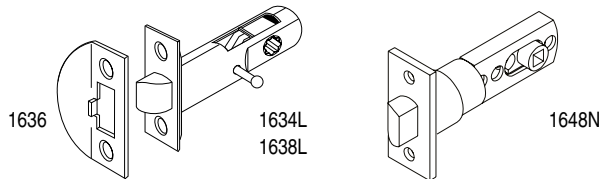

1636

1634L  
1638L

1648N

| PART # | DESCRIPTION   | BACKSET FRONT   | FINISH GROUPS |       |             |
|--------|---|-----------------|---------------|-------|-------------|
|        |   |                 | NO FINISH     | 3, 26 | 10, 10B, 32 |
| 1631   | Support housing   | —               | 9             | —     | —           |
| 1536   | "T" Strike, 2-3/4" curved lip   | —               | —             | 9     | 15          |
| 1145   | 4-7/8" ASA strike   | —               | —             | 11    | 21          |
| 1634   | Tubular deadbolt  | 2-3/4"          | —             | 104   | 111         |
| 1636   | Strike, 2-1/4" full curved lip  | —               | —             | 9     | 15          |
| 1634N  | Passage latch w/ strike   | 2-3/4"          | —             | 74    | 88          |
| 1634L  | Privacy latch w/ strike   | 1" x 2-1/4"     | —             | 88    | 98          |
| 1638N  | Passage latch w/ strike   | 2-3/8"          | —             | 48    | 60          |
| 1638L  | Privacy latch w/ strike   | 1" x 2-1/4"     | —             | 60    | 72          |
| 1648N  | UL Listed Adjustable Backset Latch<br><b>RESIDENTIAL INTERIOR LOCKSETS ONLY</b> | 2-3/8" - 2-3/4" | —             | —     | 95          |

## Turnpieces



SKA03

SKA015

1351

8101P

5108

A7616

| PART # | DESCRIPTION | FINISH GROUPS |    |     |    |             |     |
|--------|-------------|---------------|----|-----|----|-------------|-----|
|        |             | 3E            | 3  | 26D | 4  | 10, 10B, 26 | 32D |
| SKA03  | Turnpiece   | —             | —  | —   | —  | —           | 83  |
| SKA015 | Turnpiece   | 71            | 54 | 54  | 71 | 63          | —   |
| 1351   | Turnpiece   | —             | —  | 73  | —  | —           | —   |
| 8101P  | Turnpiece   | 60            | 43 | 43  | 60 | 51          | 51  |
| 5108   | Turnpiece   | —             | —  | 73  | —  | —           | —   |
| A7616  | Turnpiece   | 71            | 54 | 54  | 71 | 63          | 63  |

## Latches & Cylindrical Cartridge

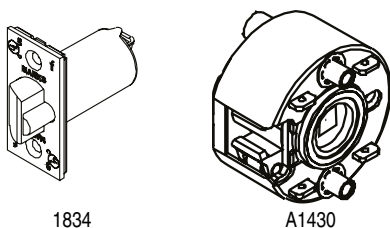

1834

A1430

Cylindrical Cartridge

NOTE: Cylindrical Cartridge is for use with E7\* Option ONLY.

| LATCH   | THROW | Backset 2-3/8";<br>Front<br>1" x 2-1/4" | Backset 2-3/4";<br>Front<br>1-1/8" x 2-1/4" | FUNCTION | FINISH GROUPS |         |
|---------|-------|---|---|----------|---------------|---------|
|         |       |   |   |          | 3, 32D        | 10, 10B |
| GRADE 2 | 1/2"  | 1138A                                   | 1134A                                       | ENTRANCE | 43            | 53      |
| GRADE 1 | 9/16" | —                                       | 1834A                                       | ENTRANCE | 89            | 96      |

| PART # | DESCRIPTION           | NO FINISH |
|--------|-----------------------|-----------|
| A1430  | Cylindrical Cartridge | 107       |

# How To Order DEFENDER LOCKSETS

| How To Order Example<br>for Defender Locksets |                                      |                      |                              |                     |   |
|---|--------------------------------------|----------------------|------------------------------|---------------------|---|
| <b>145</b>                                    | <b>K</b>                             | <b>/</b>             | <b>32D</b>                   | <b>—</b>            | <b>D1</b>   |
| <small>1.<br/>Lockset Series</small>          | <small>2.<br/>Marks Function</small> | <small>Slash</small> | <small>3.<br/>Finish</small> | <small>Dash</small> | <small>4.<br/>Options<br/>Specify: Keying, Handing<br/>&amp; Door Thickness</small> |

| 1 SERIES  |           |
|---|-----------|
| Defender Tubular Deadbolt Locksets                | 130, 130R |
| Defender Cylindrical Cartridge Deadlatch Locksets | 145, 145R |

| 2 TUBULAR FUNCTIONS   |      |                       |       |        |
|---|------|-----------------------|-------|--------|
| <b>DEADBOLT/DEADLATCHES</b> (* indicates IC Core) 130 Series 145 Series |      |                       |       |        |
| K   | RK*  | CYLINDER x TURNPIECE  | E0151 | E01101 |
| KK  | RKK* | CYLINDER x KNOB       |       |        |
| L   | RL*  | COMM. SINGLE CYLINDER | E0161 | E0131  |
| KL  | RKL* | CYLINDER x LEVER      |       | E01101 |
| M   | RM*  | DOUBLE CYLINDER       | E0141 | E01111 |
| S   | RS*  | CLASSROOM             | E0171 |        |
| X   |      | TURNPIECE             | E0191 | E01121 |

| 3 FINISH |                              |        |
|----------|------------------------------|--------|
| MARKS    |                              | ANSI # |
| US 3     | Polished Brass, Clear Coated | 605    |
| US10     | Satin Bronze, Clear Coated   | 612E   |
| US 10B   | Dark Bronze, Clear Coated    | 613E   |
| US 26D   | Satin Chrome, Plated         | 626    |
| US 32    | Polished Stainless Steel     | 629    |
| US 32D   | Satin Stainless Steel        | 630    |



| 4 OPTIONS                              |             |              |
|--|-------------|--------------|
| <b>TRIM MODIFICATIONS</b>              | <b>CODE</b> | <b>PRICE</b> |
| Tactile knob/lever, coated ext. only   | A1          | 60           |
| Tactile knob/lever, knurled            | A4          | 60           |
| Tactile knob/lever, coated int. & ext. | A18         | 122          |
| <b>DOOR THICKNESS</b>                  | <b>CODE</b> | <b>PRICE</b> |
| 50 mm (2")                             | D1          | NC           |
| 57 mm (2-1/4")                         | D2          | 51           |
| 1-1/4" - 1-1/2"                        | D8          | NC           |
| <b>LATCH</b>                           | <b>CODE</b> | <b>PRICE</b> |
| 2-3/4" backset, 1-1/8" x 2-1/4" face   | E4          | 10           |
| 2-3/8" backset, 1-1/8" x 2-1/4" face   | E11         | 12           |
| <b>TRIM CHANGES</b>                    | <b>CODE</b> | <b>PRICE</b> |
| Sargent conventional cylinder          | F8          | 22           |
| <b>CYLINDER</b>                        | <b>CODE</b> | <b>PRICE</b> |
| Less cylinder                          | G3          | Deduct 15    |
| <b>STRIKE</b>                          | <b>CODE</b> | <b>PRICE</b> |
| 4-7/8" ASA strike                      | S1          | 13           |
| 4-7/8" x 1-1/4" security strike        | S4          | 11           |



Defender Series

## DEADBOLT/DEADLATCH FUNCTIONS

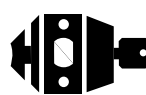
| ANSI #<br>CODE     | MARKS #<br>FUNCTION |
|--------------------|---------------------|
| <b>130 SERIES:</b> |                     |
| E0151 .....        | K                   |
| E0161 .....        | L                   |
| E0141 .....        | M                   |
| E0171 .....        | S                   |
| E0191 .....        | X                   |

| ANSI #<br>CODE     | MARKS #<br>FUNCTION |
|--------------------|---------------------|
| <b>145 SERIES:</b> |                     |
| E01101 .....       | K                   |
| E0131 .....        | L                   |
| E01101 .....       | KL                  |
| E01111 .....       | M                   |
| E01121 .....       | X                   |

| ANSI # CODE  | MARKS FUNCTION   |
|--|--|
| <b>CYLINDER x TURNPIECE:</b><br>Deadbolt/deadlatch by inside turnpiece or outside key. | I/S O/S  |
|  |  K  |
| <b>COMMUNICATING SINGLE CYLINDER:</b><br>Deadbolt/deadlatch by key from one side only. |  L  |
|  |  KL |
| <b>CYLINDER x LEVER:</b><br>Deadlatch by key outside. Inside lever always opens latch. |  |

| ANSI # CODE   | MARKS FUNCTION   |
|---|--|
| <b>DOUBLE CYLINDER:</b><br>Deadbolt/deadlatch by key either side.                                 | I/S O/S  |
|   |  M            |
| <b>CLASSROOM:</b><br>Deadbolt by outside key.<br>Turnpiece will retract but not project deadbolt. |  S            |
|   | <b>TURNPIECE x BLANK PLATE:</b><br>Deadbolt/deadlatch by inside turnpiece.<br>Blank plate outside. |

# 130 SERIES "DEFENDER" TUBULAR DEADBOLTS

| ANSI 156.5  |               |                          |        | Standard Features   |  |
|---|---------------|--------------------------|--------|---|--|
| <br>130K |               |                          |        | <ul style="list-style-type: none"> <li>Bolt: 1" throw</li> <li>Unitized assemblies for 2-1/8" bore</li> <li>Strike: #1335, 2-3/4" x 1-1/8" strike</li> <li>Door thickness: 1-3/8" to 1-7/8"</li> <li>Cylinder: MARKS "C" keyway, 6 pin w/ 2 keys</li> <li>2-3/8" Backset</li> <li>Latch front: 1" x 2-1/4"</li> </ul> |  |
| MARKS #   |               | FUNCTION                 | ANSI # | FINISH GROUPS   |  |
| COMM. CYL.  | IC CORE CYL.* |                          |        | 3, 10, 10B, 26D, 32, 32D  |  |
| K   | RK            | CYLINDER x TURNPIECE     | E0151  | 204   |  |
| L   | RL            | COMMUNICATING SINGLE CYL | E0161  | 204   |  |
| M   | RM            | DOUBLE CYLINDER          | E0141  | 197   |  |
| S   | RS            | CLASSROOM                | E0171  | 178   |  |
| X   | —             | TURNPIECE x BLANK PLATE  | E0191  | 143   |  |

**DEADBOLTS ARE PACKED 24 PER CASE**

**NOTE:** Split designs and/or finishes are priced at the highest design and/or finish • Special finishes, consult factory  
• IC Core Models: Core not included

| OPTIONS                              | CODE | PRICE     |
|--------------------------------------|------|-----------|
| For 2" door                          | D1   | NC        |
| For 2-1/4" door                      | D2   | 51        |
| For 1-1/4" - 1-1/2" door             | D8   | NC        |
| 2-3/4" backset, 1-1/8" x 2-1/4" face | E4   | 11        |
| For 1-1/2" bore                      | F6   | 20        |
| Sargent original cylinder or core    | F8   | 22        |
| Less cylinder                        | G3   | Deduct 15 |
| 3-5/8" x 1-1/4" Security strike      | S4   | 13        |

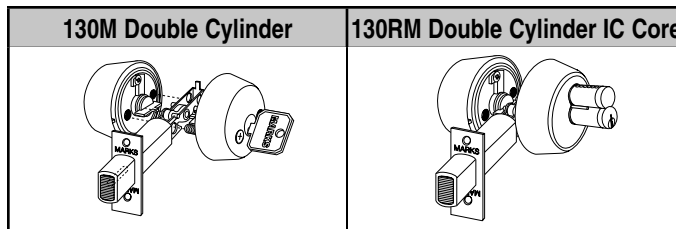

**\* Standard IC Core Models:** 

Interchangeable Core models for 6 or 7 pin cores (not included).  
Accepts: Marks, Medeco KeyMark™, Falcon & Best®. IC Core Tailpieces ARE Included.

# 145 SERIES "DEFENDER" CYLINDRICAL CARTRIDGE DEADLATCHES

| BHMA CERTIFIED  |               | ANSI 156.5 • 3 Hour Fire Rating | UL LISTED | Standard Features  |  |
|---|---------------|---------------------------------|-----------|--|--|
| <br>145M |               |                                 |           | <ul style="list-style-type: none"> <li>Series 1 Cylindrical Cartridge</li> <li>Latch: Grade 1, 9/16" throw, 2-3/4" backset</li> <li>Unitized assemblies for 2-1/8" bore</li> <li>Strike: #1136, 2-3/4" strike</li> <li>Door thickness: 1-3/4"; For 1-3/8" doors use spacer rings K1442/32D</li> <li>Cylinder: MARKS "C" keyway, 6 pin w/ 2 keys</li> <li>Latch front: 1-1/8" x 2-1/4"</li> </ul> |  |
| MARKS #   |               | FUNCTION                        | ANSI #    | FINISH GROUPS  |  |
| COMM. CYL.  | IC CORE CYL.* |                                 |           | 3, 10, 10B, 32, 32D  |  |
| K   | RK            | CYLINDER x TURNPIECE            | E01101    | 220  |  |
| L   | RL            | COMMUNICATING SINGLE CYL        | E0131     | 220  |  |
| M   | RM            | DOUBLE CYLINDER                 | E01111    | 239  |  |
| X   | —             | TURNPIECE x BLANK PLATE         | E01121    | 187  |  |
| KL  | RKL           | CYLINDER x LEVER                | E01101    | 373  |  |
| KK  | RKK           | CYLINDER x KNOB                 |           | 387  |  |

**DEADLATCHES ARE PACKED 24 PER CASE**

**NOTE:** Split designs and/or finishes are priced at the highest design and/or finish • Special finishes, consult factory  
• IC Core Models: Core not included

| OPTIONS                              | CODE | PRICE     |
|--------------------------------------|------|-----------|
| For 2" door                          | D1   | NC        |
| For 2-1/4" door                      | D2   | 53        |
| 2-3/8" backset, 1-1/8" x 2-1/4" face | E11  | 13        |
| Sargent original cylinder or core    | F8   | 22        |
| Less cylinder                        | G3   | Deduct 15 |
| 4-7/8" ASA strike                    | S1   | 13        |

**\* Standard IC Core Models:** 

Interchangeable Core models for 6 or 7 pin cores (not included).  
Accepts: Marks, Medeco KeyMark™, Falcon & Best®. IC Core Tailpieces ARE Included.

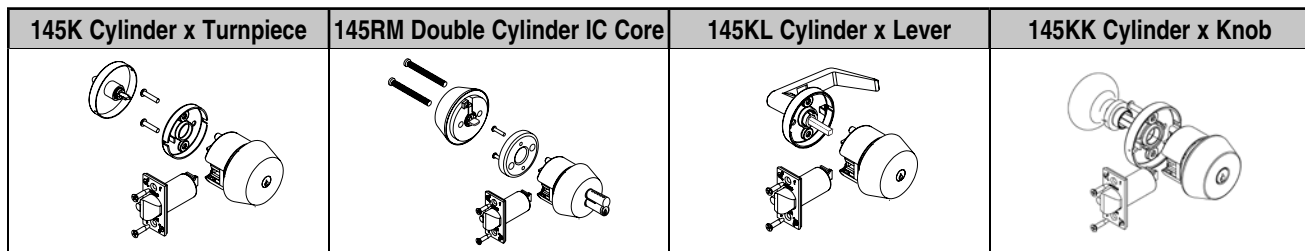

# DEFENDER SERIES ACCESSORIES

## Strikes, Latches & Spacers

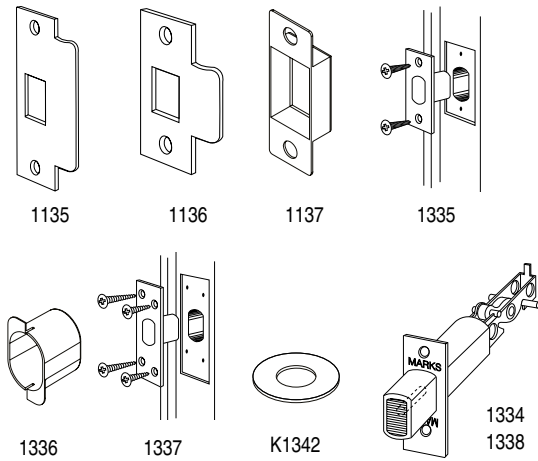

| PART #    | DESCRIPTION   | FINISH GROUPS |        |             |
|-----------|---|---------------|--------|-------------|
|           |   | NO FINISH     | 3, 32D | 10, 10B, 32 |
| 1135      | 4-7/8" ASA STRIKE   | —             | 22     | 22          |
| 1136      | 2-3/4" "T" STRIKE W/DUST BOX                              | —             | 9      | 14          |
| 1137      | DUST BOX, PLASTIC, LATCH                                  | 5             | —      | —           |
| 1335      | 2-3/4" x 1-1/8" STANDARD STRIKE                           | —             | 7      | 9           |
| 1336      | DUST BOX, PLASTIC, DEADBOLT                               | 5             | —      | —           |
| 1337      | 3-5/8" x 1-1/4" HIGH SECURITY STEEL STRIKE, PLATED FINISH | —             | 66     | —           |
| K1342     | 1-3/8" DOOR, ROSE EXTENDERS, 130 Series                   | —             | 52     | 65          |
| DEADBOLTS |   |               |        |             |
| 1334      | 2-3/4" BACKSET FRONT 1-1/8" x 2-1/4"                      | —             | 34     | 43          |
| 1338      | 2-3/8" BACKSET FRONT 1-1/8" x 2-1/4"                      | —             | 34     | 43          |
| K1442     | 1-3/8" DOOR, 145 SERIES                                   | —             | 150    | —           |

## Latches & Cylindrical Cartridge

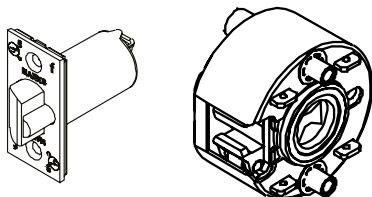

1834

A1420 Cylindrical Cartridge  
for use with 145 Series

NOTE: Cylindrical Cartridge is  
for use with E7\* Option ONLY.

| LATCH   | THROW | Backset 2-3/8"<br>Front<br>1" x 2-1/4" | Backset 2-3/4"<br>Front<br>1-1/8" x 2-1/4" | FUNCTION | FINISH GROUPS |         |
|---------|-------|--|--|----------|---------------|---------|
|         |       |  |  |          | 3, 32D        | 10, 10B |
| GRADE 2 | 1/2"  | 1138A                                  | 1134A                                      | ENTRANCE | 43            | 53      |
| GRADE 1 | 9/16" | —                                      | 1834A                                      | ENTRANCE | 89            | 96      |

| PART # | DESCRIPTION                                   | NO FINISH |
|--------|---|-----------|
| A1420  | Cylindrical Cartridge for use with 145 Series | 107       |

## Tailpieces & Cylinders

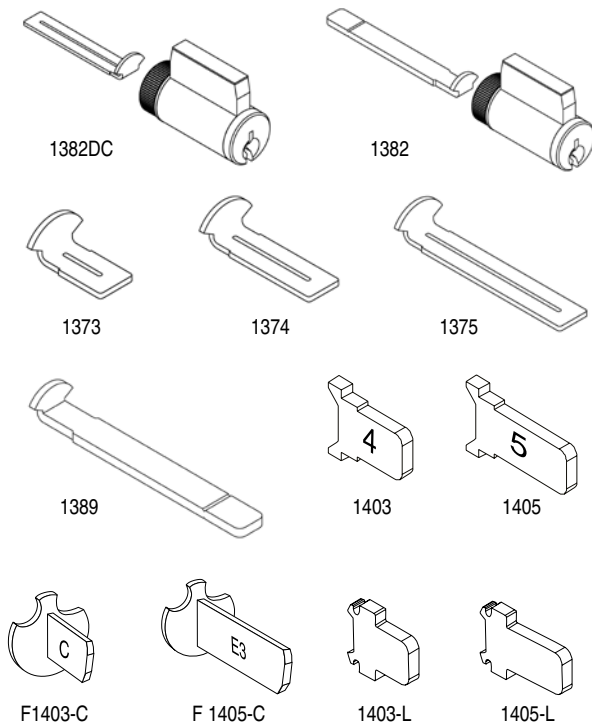







| PART #                         | TAILPIECES FOR 130 DEADBOLTS | PRICE                     |
|--------------------------------|------------------------------|---------------------------|
| DOUBLE CYLINDER                |                              |                           |
| 1373                           | 1-5/16" to 1-3/8"            | MARKS<br>1382DC           |
| 1374                           | 1-5/8" to 2"                 |                           |
| 1375                           | 2-1/8" to 2-3/8"             |                           |
| SINGLE CYLINDER                |                              |                           |
| 1389                           | 1-3/4" to 2-1/4"             | MARKS<br>1382             |
| TAILPIECES FOR 145 DEADLATCHES |                              |                           |
| 1403                           | 1-5/8" to 1-7/8"             | MARKS<br>TAILPIECE        |
| 1405                           | 2" to 2-1/4"                 |                           |
| F1403-C                        | 1-5/8" to 1-7/8"             | SCHLAGE®<br>TAILPIECE     |
| F1405-C                        | 2" to 2-1/4"                 |                           |
| 1403-L                         | 1-5/8" to 1-7/8"             | LORI / ILCO<br>TAILPIECES |
| 1405-L                         | 2" to 2-1/4"                 |                           |

# I-QWIK LITE<sup>2</sup> SERIES



## NO-NONSENSE ACCESS CONTROL RIGHT OUT OF THE BOX

| MARKS #   |   | LOCKSET TYPE - PACKED PER CASE   | # OF USERS | FINISH GROUPS                                     |                     |
|---|---|--|------------|---|---------------------|
| IQ1LITE   | IQ1L/26D  |  |            | 19 Black Powder Coat;<br>with 26D American Levers | 26D<br>Satin Chrome |
|  |  | <b>IQ1:</b><br>Cylindrical Lockset - <i>PACKED 4 PER CASE</i>  | 160        | 551   | 635                 |
|  |  | <b>IQ2:</b><br>Mortise Lockset - <i>PACKED 4 PER CASE</i>  | 160        | 890   | 974                 |
|  |  | <b>IQ7:</b><br>Rim Exit Device Interface - <i>PACKED 6 PER CASE</i><br><i>Adapter plates operate most manufacturers Rim Exit Devices.</i><br><i>Adapter plates for Mounting Exit Devices are sold separately, see page 70.</i> | 160        | 774   | 858                 |

Access Control

### Standard Features

- **CableGard™** protects wires for easy installation
- Standard ANSI door prep with one additional hole
- Pre-programmed code
- Keypad programmable
- 160 User codes
- Temporary user codes
- Passage mode
- Pin only mode
- Double code entry for maximum security
- Two wire remote release
- 16 Digit tactile metal keypad
- Weatherproof standard
- Audible & visible entry indicator
- Audible low battery alert
- 4 "AA" batteries, 95,000 operations
- Easy installation
- Lifetime Mechanical Warranty; 2 Year Electronic Warranty

#### IQ1 LITE Cylindrical Lockset Specifications

Door Thickness: 1-3/4" standard;  
*For thicker doors, Consult factory*

Handing: Non-handed

Key Override: Marks "C" keyway, 6 pin w/2 keys, IC Core optional

Lock Body: Cylindrical "Survivor" featuring the "Clutch" for trouble free service

Latch: Grade 2, 2-3/4" backset, 1/2" throw, 3 Hour UL fire rating

Strike Plate: 4-7/8" ASA strike

#### IQ2 LITE Mortise Lockset Specifications

Door Thickness: 1-3/4" standard;  
*For thicker doors, Consult factory*

Handing: Field reversible

Key Override: 1-1/8" Mortise cylinder, 6 pin w/2 keys

Lock Body: Grade 1, Series 5, 2-3/4" backset, 3/4" anti-friction latch, 3 Hr UL fire rating

Auxiliary Latch: 1/2" throw

Bolt Throw: 1" (Optional deadbolt functions - Consult factory)

Clutch: The "Clutch" for trouble free service

Strike Plate: 4-7/8" ASA standard

#### IQ7 LITE Rim Exit Device Interface Specifications

Door Thickness: 1-3/4" standard;  
*For thicker doors, Consult factory*

Handing: Non-handed

Key Override: 1-1/8" Mortise cylinder, 6 pin w/2 keys

Clutch: The "Clutch" for trouble free service

**Adapter plates operate most manufacturers Rim Exit Devices. Adapter plates for Mounting Exit Devices are sold separately, see page 70.**

### How To Order Example for i-Qwik LITE Series Electronic Access Control Locksets

| IQ                   | 1LITE              |            |
|----------------------|--------------------|------------|
| 1.<br>Lockset Series | 2.<br>Model Number | 26D Finish |

IQ

1LITE (Cylindrical)

1L/26D (Cylindrical)

2LITE (Mortise)

2L/26D (Mortise)

7LITE (Rim Exit Device Interface)

7L/26D (Rim Exit Device Interface)

# I-QWIK/I-QUE SERIES

## OPTIONS



| I-QWIK / I-QUE OPTIONS                    |      |           | Cylindrical |        |        | Mortise |        |        | Rim Exit Device Interface |        |        |
|---|------|-----------|-------------|--------|--------|---------|--------|--------|---------------------------|--------|--------|
| DESCRIPTION                               | CODE | PRICE     | IQLITE      | IQDATA | IQPROX | IQLITE  | IQDATA | IQPROX | IQLITE                    | IQDATA | IQPROX |
| <b>Backset</b>                            |      |           |             |        |        |         |        |        |                           |        |        |
| 2-3/8" Backset                            | E6   | NC        | •           | •      | •      |         |        |        |                           |        |        |
| 5" Backset                                | E9   | 47        | •           | •      | •      |         |        |        |                           |        |        |
| 3-3/4" Backset                            | E10  | 47        | •           | •      | •      |         |        |        |                           |        |        |
| Series 55 Mortise Lock Body (2-1/2" bkst) | W8   | NC        |             |        |        | •       | •      | •      |                           |        |        |
| <b>Levers</b>                             |      |           |             |        |        |         |        |        |                           |        |        |
| Tactile Lever                             | A1   | 60        | •           | •      | •      | •       | •      | •      | •                         | •      | •      |
| Lever to accept Sargent conventional cyl. | F8   | 23        | •           | •      | •      |         |        |        |                           |        |        |
| Lever to accept Corbin conventional cyl.  | F9   | 23        | •           | •      | •      |         |        |        |                           |        |        |
| Lever to accept Corbin IC Core 6 pin      | F12  | 34        | •           | •      | •      |         |        |        |                           |        |        |
| Lever to accept Corbin IC Core 7 pin      | F13  | 34        | •           | •      | •      |         |        |        |                           |        |        |
| Lever to accept Yale IC Core 6 pin        | F14  | 23        | •           | •      | •      |         |        |        |                           |        |        |
| Lever to accept Yale IC Core 7 pin        | F15  | 23        | •           | •      | •      |         |        |        |                           |        |        |
| Lever to accept Schlage IC Core 6 pin     | F19  | 23        | •           | •      | •      |         |        |        |                           |        |        |
| Lever to accept Sargent IC Core           | F20  | 23        | •           | •      | •      |         |        |        |                           |        |        |
| Lever to accept Medeco IC Core lg. format | F21  | 23        | •           | •      | •      |         |        |        |                           |        |        |
| Monaco Lever                              | W3   | 20        | •           | •      | •      | •       | •      | •      | •                         | •      | •      |
| Solid Exterior Handle (no cylinder)       | W4   | NC        | •           | •      | •      | Std     | Std    | Std    | Std                       | Std    | Std    |
| Crescent Lever                            | W7   | 20        | •           |        |        | •       | Std    | Std    | •                         | Std    | Std    |
| Titan Lever                               | W12  | 20        | •           | •      | •      | •       | •      | •      | •                         | •      | •      |
| <b>Cylinder</b>                           |      |           |             |        |        |         |        |        |                           |        |        |
| IC Core Cylinder Housing                  | G1   | NC        | •           | •      | •      | •       | •      | •      | •                         | •      | •      |
| Less Cylinder                             | G3   | Deduct 15 | •           | •      | •      | •       | •      | •      | •                         | •      | •      |
| <b>Strike</b>                             |      |           |             |        |        |         |        |        |                           |        |        |
| 4-7/8" ASA Strike                         | S1   | 13        | •           | Std    | Std    | Std     | Std    | Std    |                           |        |        |
| 2-3/4" "T" Strike                         | S3   | NC        | Std         | •      | •      |         |        |        |                           |        |        |
| <b>Miscellaneous</b>                      |      |           |             |        |        |         |        |        |                           |        |        |
| Tamper-proof Screws                       | A3   | 14        | •           | •      | •      | •       | •      | •      | •                         | •      | •      |
| Lead Lined IQ                             | F22  | 511       | •           | •      | •      | •       | •      | •      | •                         | •      | •      |

Access Control









# I-QWIK/I-QUE SERIES



## ACCESSORIES, TAILPIECES & CAMS

| I-QWIK / I-QUE ACCESSORIES  |        |       | Cylindrical |        |        | Mortise |        |        | Rim Exit Device Interface |        |        |
|---|--------|-------|-------------|--------|--------|---------|--------|--------|---------------------------|--------|--------|
| ACCESSORY   | PART # | PRICE | IQLITE      | IQDATA | IQPROX | IQLITE  | IQDATA | IQPROX | IQLITE                    | IQDATA | IQPROX |
| Bridge rectifier (converts AC power to DC power)  | 1901   | 41    | •           | •      | •      | •       | •      | •      | •                         | •      | •      |
| Gasket<br>(interior inside housing for full weatherproofing)                                | E1108  | 7     | •           | •      | •      | •       | •      | •      |                           |        |        |
| Battery Pack Holder   | EA4011 | 20    | •           | •      | •      | •       | •      | •      | •                         | •      | •      |
| Spacer Kit, 1-3/8" Door (Int. & Ext. Gaskets)   | EK1038 | 60    | •           | •      | •      | •       | •      | •      | •                         | •      | •      |
| Internal power connector for<br>hardwiring i-Qwik/i-Que Locksets                            | E1133  | 29    | •           | •      | •      | •       | •      | •      | •                         | •      | •      |
| Memory Reset Jumper   | E1155  | 20    | •           | •      | •      | •       | •      | •      | •                         | •      | •      |
| Spacer Ring for 1-1/4" mortise cylinder   | E2006  | 20    |             |        |        | •       | •      | •      | •                         | •      | •      |
| Spacer Ring for 1-3/8" mortise cylinder   | E2007  | 20    |             |        |        | •       | •      | •      | •                         | •      | •      |
| Von Duprin 99 Rim Adapter Plate / M9900 Marks<br>Detex Advantex 10 Series Rim Adapter Plate | E7071  | 78    |             |        |        |         |        |        | •                         | •      | •      |
| Precision 1100 Rim Adapter Plate  | E7072  | 78    |             |        |        |         |        |        | •                         | •      | •      |
| Yale 7100 Rim Adapter Plate/<br>Corbin ED5200 Rim Adapter Plate                             | E7073  | 78    |             |        |        |         |        |        | •                         | •      | •      |
| Dorma 9300 Rim Adapter Plate  | E7074  | 78    |             |        |        |         |        |        | •                         | •      | •      |
| Sargent 8800 Rim Adapter Plate/<br>Arrow 3800 Rim Adapter Plate                             | E7075  | 78    |             |        |        |         |        |        | •                         | •      | •      |
| Precision 21 Rim Adapter Plate/<br>Precision 2100 Rim Adapter Plate**                       | E7076  | 78    |             |        |        |         |        |        | •                         | •      | •      |
| Von Duprin 88 - <b>Special Order, Consult Factory</b>                                       | E7077  | 78    |             |        |        |         |        |        | •                         | •      | •      |
| Monarch 18R Exit Device Adapter Plate   | E7078  | 88    |             |        |        |         |        |        | •                         | •      | •      |

NOTE: Consult Factory for Additional Exit Devices; \*\*Must use Precision #BP21 backplate.

### TAILPIECES & CAMS

| CYLINDRICAL TAILPIECES Cylindrical Conventional                                     |  |            |      |       |
|---|--|------------|------|-------|
| FOR USE WITH  |  | LEVER      | CODE | PRICE |
|  | Marks 1982   | E1903      | E1   | 6     |
|  | Arrow PK 100C, ILCO 705,<br>Sargent 13-3266, Lori 1539,<br>ASSA 65673, 65691, Abloy                      | E1903-L    | E2   | 6     |
|  | Schlage® 23-001, Primus<br>Corbin-Russwin 2000-034   | EF1903-C   | E3   | 8     |
| CYLINDRICAL IC CORES  |  |            |      |       |
|  | Kit for 6 & 7 pin Marks, KSP, Best®, Falcon,<br>Medeco® Keymark, Schlage® Small Format,<br>6 pin Sargent | HER1984    | ER   | 6     |
|  | Kit for 6 & 7 pin Corbin   | HER1984-G  | ERG  | 6     |
|  | Kit for 6 & 7 pin Yale™<br>American Lever <b>ONLY</b>  | EAR1989-Y  | EMY  | 8     |
|  | 6 pin Schlage® Large Format<br>American Lever <b>ONLY</b>  | EF1903-F19 | CM   | 8     |

| CAMS  |                           |        |      |       |
|---|---------------------------|--------|------|-------|
| Straight cam for tubular, exit device, or mortise functions Z1 & Z4 only.           |                           |        |      |       |
|  | USE WITH MORTISE CYLINDER | PART # | CODE | PRICE |
|   | MARKS                     | 2101   | 1    | 6     |
|   | Arrow/Sargent             | 2101-A | A1   | 6     |
|   | Corbin Russwin            | 2101-C | C1   | 6     |
|   | Schlage®                  | 2101-S | S1   | 6     |
| CAMS  |                           |        |      |       |
| Cloverleaf cam for mortise functions Z2, Z3, Z5, Z6 only.                           |                           |        |      |       |
|  | USE WITH MORTISE CYLINDER | PART # | CODE | PRICE |
|   | MARKS                     | 2102   | 2    | 6     |
|   | Arrow/Sargent             | 2102-A | A2   | 6     |
|   | Corbin Russwin            | 2102-C | C2   | 6     |
|   | Schlage®                  | 2102-S | S2   | 6     |



# REQUEST To EXIT (REX) CYLINDRICAL ELECTRIFIED LEVERSET



ANSI-A156.2 • Grade 1  
3 Hour Fire Rating



Marks USA has developed the Grade 1 "Survivor" Series Cylindrical Lockset incorporating a Request to Exit (REX) switch in both Electrified and Storeroom functions. Activating the inside lever for egress initiates the built-in REX output, providing a momentary signal for the access control REX input, for alarm shunt during egress.

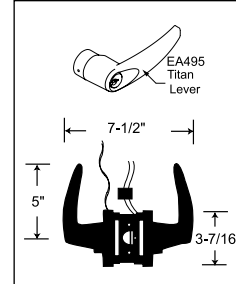
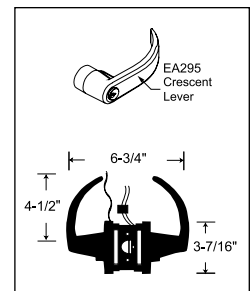
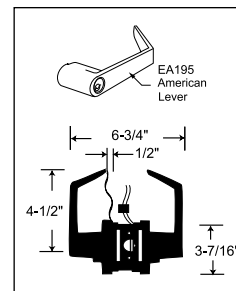

| Standard Features  |   |   |
|--|---|---|
| <ul style="list-style-type: none"> <li>Backsets: 2-3/4"; 2-3/8", 3-3/4" or 5" optional</li> <li>Latch #1834, Front: 1-1/8" x 2-1/4"; Throw: 9/16"; Stainless steel nose</li> <li>Levers: Solid cast Zamac w/ 1/2" return (except 395 &amp; 495)</li> </ul> | <ul style="list-style-type: none"> <li>Rose: Thru-bolted, 3-7/16" dia., spring loaded 2-#10 thru-bolts</li> <li>Strike: #1135, 4-7/8" ASA curved lip</li> <li>Door thickness: 1-5/8" to 1-7/8" (For 1-3/8" door use K1704 spacer)</li> <li>Cylinder: MARKS "C" keyway, 6 pin w/ 2 keys</li> </ul> | <ul style="list-style-type: none"> <li>Request to Exit Switch: Single pole, double throw, 3 amp, 125 AC, wired either normally open or normally closed</li> <li>Electrified functions - 100% duty cycle, 24V/DC standard, supplied with bridge rectifier; 3 watts, .25amps</li> <li>12V/DC Optional, Contact factory for additional options</li> <li>Features "The Clutch" • UL Listed, 3 hour fire rating</li> </ul> |

| LOCKSET & LEVER DESIGN | CON. CORE | IC CORE | FUNCTION              | ANSI # | DESCRIPTION  | FINISH GROUPS |                   |
|------------------------|-----------|---------|-----------------------|--------|--|---------------|-------------------|
|                        |           |         |                       |        |  | 26D           | 3, 4, 10, 10B, 26 |
| EA195 American lever   | F         | RF      | STOREROOM             | F86    | Latch by lever inside. Outside lever always locked.  | 600           | 684               |
| EA295 Crescent lever   |           |         |                       |        |  |               |                   |
| EA395 Monaco lever     |           |         |                       |        |  |               |                   |
| EA495 Titan lever      |           |         |                       |        |  |               |                   |
| EA195 American lever   | FEL       | RFEL    | ELECTRICALLY LOCKED   | —      | Outside always locked electrically. Open by key outside, switch or loss of power. Latch by lever inside. | 812           | 896               |
| EA295 Crescent lever   |           |         |                       |        |  |               |                   |
| EA395 Monaco lever     |           |         |                       |        |  |               |                   |
| EA495 Titan lever      |           |         |                       |        |  |               |                   |
| EA195 American lever   | FEU       | RFEU    | ELECTRICALLY UNLOCKED | —      | Outside always locked until unlocked by key or electrically energized. Latch by lever inside.            | 812           | 896               |
| EA295 Crescent lever   |           |         |                       |        |  |               |                   |
| EA395 Monaco lever     |           |         |                       |        |  |               |                   |
| EA495 Titan lever      |           |         |                       |        |  |               |                   |

LEVERSETS ARE PACKED 6 PER CASE

\* Standard IC Core Models: Interchangeable Core models for 6 or 7 pin cores (not included).  
 Accepts: Marks, Medeco KeyMark™, Falcon & Best®.  
 IC Core Tailpieces ARE Included.



Electrified Locksets

## How To Order Example for REX Leversets

|                      |                      |          |              |          |               |
|----------------------|----------------------|----------|--------------|----------|---------------|
| <b>EA195</b>         | <b>F</b>             | <b>/</b> | <b>26D</b>   | <b>—</b> | <b>G3</b>     |
| 1.<br>Lockset Series | 2.<br>Marks Function | Slash    | 3.<br>Finish | Dash     | 4.<br>Options |

### LOCK SERIES

- EA195
- EA295
- EA395
- EA495

### MARKS FUNCTION

- \_\_\_ F    \_\_\_ RFEL
- \_\_\_ RF    \_\_\_ FEU
- \_\_\_ FEL    \_\_\_ RFEU

### FINISH

- 3     4
- 10     10B
- 26     26D

### OPTIONS

\_\_\_\_\_  
 \_\_\_\_\_  
 \_\_\_\_\_

# ELECTRIFIED LOCKSETS

## CYLINDRICAL LEVERSETS & MORTISE LOCKSETS

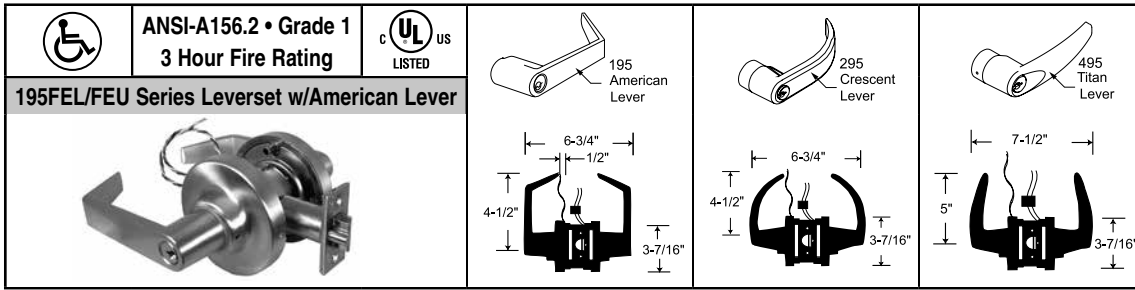

### Series 195, 295, 395, 495 Cylindrical Leverset Standard Features

- Backsets: 2-3/4", 2-3/8", 3-3/4", 5"
- Latch #1834, Front: 1-1/8" x 2-1/4"; Throw: 9/16"; Stainless steel nose
- Levers: Solid cast Zamac w/ 1/2" return
- Rose: Thru-bolted, 3-7/16" dia., spring loaded 2-#10 thru-bolts
- Strike: #1135, 4-7/8" ASA curved lip
- Door thickness: 1-5/8" to 1-7/8" (For 1-3/8" door use K1704 spacer)
- Cylinder: MARKS "C" keyway, 6 pin w/ 2 keys or IC Core housing
- Electrified functions - 100% duty cycle, 24V/AC supplied with bridge rectifier; 24V/DC, .21 Amps
- 12V/DC Optional, Contact factory for additional options
- Features "The Clutch"
- UL Listed, 3 hour fire rating

| SERIES 195, 295, 395, 495 GRADE 1 ELECTRIFIED CYLINDRICAL LEVERSETS |                  |                                     |  | FINISH GROUPS |                |
|---|------------------|-------------------------------------|--|---------------|----------------|
| COMMERCIAL CYLINDER   | IC CORE CYLINDER | MARKS FUNCTION                      | DESCRIPTION  | 3, 26D        | 4, 10, 10B, 26 |
| FEL   | RFEL             | ELECTRICALLY LOCKED (Fail Safe)     | Outside always locked electrically. Open by key outside, switch or loss of power. Deadlocking latch by lever inside. Lever only. | 668           | 752            |
| FEU   | RFEU             | ELECTRICALLY UNLOCKED (Fail Secure) | Outside always locked until unlocked by key or electrically energized. Deadlocking latch by lever inside. Lever only.            |               |                |

\* Standard IC Core Models: Accepts: Marks, Medeco KeyMark™, Interchangeable Core models Falcon & Best®. for 6 or 7 pin cores (not included). IC Core Tailpieces ARE Included.



Electrified Locksets

### Series 5 Electrified Mortise Lockset Standard Features

- 2-3/4" Backset ONLY
- 1" Stainless steel bolt throw
- 3/4" Latch throw (anti-friction) separator
- 1/2" Auxiliary latch throw
- Stamped steel case .090 thick., Zinc dichromate finish
- 1-1/4" x 8" Lock front, Adjustable bevel
- Steel hubs, 9/32" on diamond, 5/16" on square w/security separator
- 100% Duty Cycle 24V/DC, 12V/DC Optional supplied with bridge rectifier (350 ma)

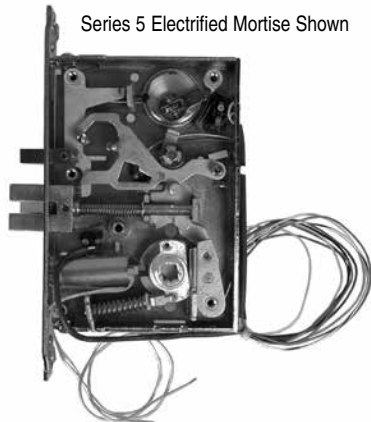

| OPTIONS  | CODE | PRICE |
|--|------|-------|
| Auxiliary Latch                                  | E3   | 46    |
| Request to EXit Switch                           | W10  | 136   |
| Key Override Sensor                              | W11  | 144   |
| Request to EXit switch, Key Sensor & Bolt Sensor | W13  | 454   |
| Bolt Sensor                                      | W14  | 166   |
| Latch Sensor                                     | W15  | 166   |

| SERIES 5 ELECTRIFIED MORTISE LOCKSET       |  |        | FINISH GROUPS |  |
|--|--|--------|---------------|--|
| MARKS FUNCTION                             | DESCRIPTION  | 3, 32D | 10, 10B, 32   |  |
| EL:<br>ELECTRICALLY LOCKED (Fail Safe)     | Outside always locked electrically. Open by key outside, switch or loss of power. Auxiliary latch deadlocks latch. Inside always open. | 870*   | 890*          |  |
| EU:<br>ELECTRICALLY UNLOCKED (Fail Secure) | Outside always locked until unlocked by key or electrically energized. Auxiliary latch deadlocks latch. Inside always open.            |        |               |  |

\* Lock Body Price ONLY. Due to numerous trim and finish options, please refer to the Marks USA Mortise Lockset Price Book.

# GATE LOCKS (Reversible)

US PAT.#4,875,725 "NO FALL OUT" FEATURE:  
Parts will not fall out when cover is removed.  
Replaces Multilock gate locks.

## Swinging Gate Locks

### Standard Features

- Easily reversible
- Case, cast aluminum 3-5/8" x 6-1/4" x 1"
- Bronze powder coat finish
- Groove: 1/2" wide x 3/16" deep, all sides for wire gate insertion
- 5 pin cylinder(s)
- Lock only, no keeper furnished

Single  
Cylinder Model  
\*With cylinder  
Suffix K  
Add \$31

Double  
Cylinder Model  
\*With cylinders  
Suffix M  
Add \$63

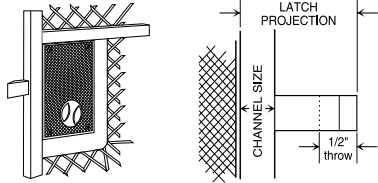

**GATE LOCKS ARE PACKED 12 PER CASE**

| MODEL # | LATCH PROJECTION | CHANNEL SIZE | PRICE LESS CYL.* | WT. / LBS. |
|---------|------------------|--------------|------------------|------------|
| W3700   | 1-1/8"           | 1/2"         | 147              | 20         |
| W3710   | 1-1/4"           | 5/8"         | 147              | 20         |
| W3720   | 1-3/8"           | 3/4"         | 147              | 20         |
| W3730   | 1-7/8"           | 1-1/4"       | 165              | 20         |
| W3750   | 1-1/8"           | 1/2"         | 207              | 21         |
| W3760   | 1-1/4"           | 5/8"         | 207              | 21         |
| W3770   | 1-3/8"           | 3/4"         | 207              | 21         |
| W3780   | 1-7/8"           | 1-1/4"       | 228              | 21         |

## Sliding Gate Locks

### Standard Features

- Easily reversible
- Case, cast aluminum 3-5/8" x 6-1/4" x 1"
- Bronze powder coat finish
- Groove: 1/2" wide x 3/16" deep, all sides for wire gate insertion
- 5 pin cylinder(s)
- Lock only, no keeper furnished

Single  
Cylinder Model  
\*With cylinder  
Suffix K  
Add \$31

Double  
Cylinder Model  
\*With cylinders  
Suffix M  
Add \$63

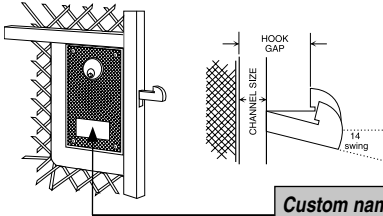

Custom nameplate available.  
Consult factory.

| MODEL # | HOOK GAP | CHANNEL SIZE | PRICE LESS CYL.* | WT. / LBS. |
|---------|----------|--------------|------------------|------------|
| W3800   | .825"    | 1/2"         | 147              | 21         |
| W3810   | .950"    | 5/8"         | 147              | 22         |
| W3820   | 1.075"   | 3/4"         | 147              | 21         |
| W3830   | 1.625"   | 1-1/4"       | 165              | 22         |
| W3850   | .825"    | 1/2"         | 207              | 22         |
| W3860   | .950"    | 5/8"         | 207              | 22         |
| W3870   | 1.075"   | 3/4"         | 207              | 22         |
| W3880   | 1.625"   | 1-1/4"       | 228              | 22         |

**GATE LOCKS ARE PACKED 12 PER CASE**

## Parts

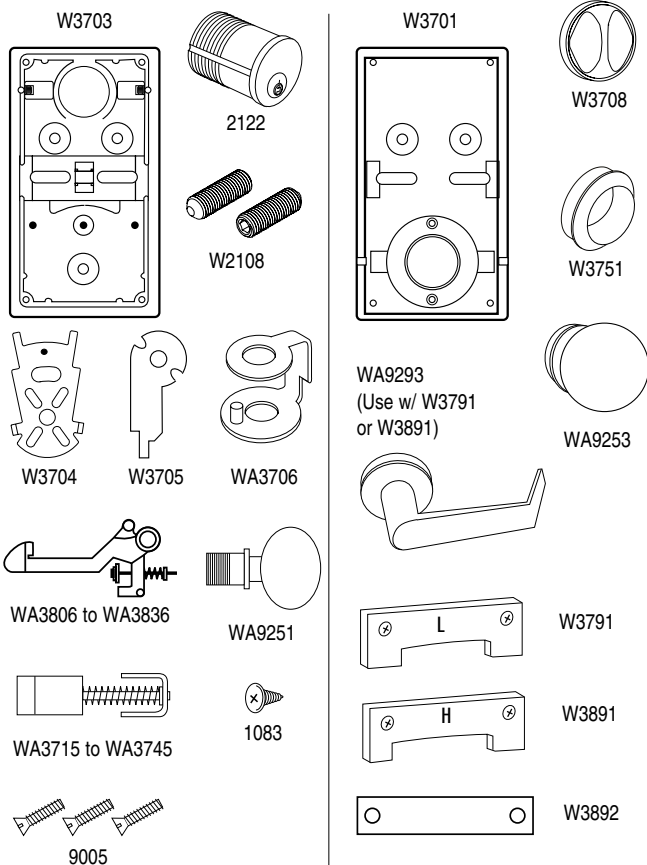

| PART # | DESCRIPTION                                     | PRICE |
|--------|---|-------|
| 1083   | Retainer/fork screw                             | .61   |
| 2122   | Mortise cylinder                                | 43    |
| W2108  | Cylinder set screw                              | .61   |
| 9005   | Case screw                                      | .61   |
| W3701  | Cover   | 43    |
| W3703  | Case  | 67    |
| W3704  | Fork  | 8     |
| W3705  | Latch lever                                     | 7     |
| W3708  | Turnpiece                                       | 22    |
| W3751  | Double cylinder collar with set screw           | 43    |
| W3791  | Lever stop plate - Swinging gate lock (w/W3892) | 14    |
| W3891  | Lever stop plate - Sliding gate lock (w/W3892)  | 14    |
| W3892  | Lever slide cover                               | 5     |
| WA3706 | Latch adapter                                   | 14    |
| WA3715 | Latch assembly - 1-1/8" projection              | 32    |
| WA3725 | Latch assembly - 1-1/4" projection              | 32    |
| WA3735 | Latch assembly - 1-3/8" projection              | 32    |
| WA3745 | Latch assembly - 1-7/8" projection              | 43    |
| WA3806 | Hook assembly - .825" gap                       | 43    |
| WA3816 | Hook assembly - .950" gap                       | 43    |
| WA3826 | Hook assembly - 1.075" gap                      | 43    |
| WA3836 | Hook assembly - 1.625" gap                      | 53    |
| WA9251 | Exterior knob assembly                          | 87    |
| WA9253 | Interior knob assembly                          | 87    |
| WA9293 | Interior lever assembly (with W3791 & W3891)    | 129   |

# SERIES HA113 CUSTOM LOCK DIVISION

## HOUSING AUTHORITY MORTISE LOCKSET

Custom Locksets

| SERIES HA113                                |                               |          | BHMA<br>CERTIFIED |
|---|-------------------------------|----------|-------------------|
|   |                               |          | FINISH<br>GROUPS  |
| MARKS #                                     | FUNCTION                      | ANSI #   | 20A               |
| <b>KEYED SINGLE CYLINDER, NO DEADBOLT</b>   |                               |          |                   |
| D   | OFFICE VESTIBULE              |          | 561               |
| DW  | VESTIBULE                     |          |                   |
| E   | OFFICE                        | F04      |                   |
| EW  | STOREROOM                     | F07      |                   |
| GL  | INST. PRIVACY                 | F26      |                   |
| J   | CLASSROOM                     | F05      |                   |
| JM, JR                                      | HOSPITAL (HOLDBACK)           | F06      |                   |
| EL  | ELECTRICALLY LOCKED           |          | 1118              |
| EU  | ELECTRICALLY UNLOCKED         |          |                   |
| <b>KEYED SINGLE CYLINDER, WITH DEADBOLT</b> |                               |          |                   |
| A   | ENTRANCE                      | F08, F10 | 576               |
| B   | ENTRANCE                      | F21      |                   |
| F   | DORMITORY                     | F12      |                   |
| FS  | DORMITORY                     |          |                   |
| FW  | DORMITORY                     | F13      |                   |
| FD  | APARTMENT                     | F20      | 617               |
| H   | HOTEL                         | F15      |                   |
| LH  | SPEC. PRIVACY                 |          |                   |
| <b>KEYED DOUBLE CYLINDER, NO DEADBOLT</b>   |                               |          |                   |
| G   | ENTRANCE                      | F09      | 617               |
| GC  | INTRUDER LATCHBOLT            | F32      |                   |
| GG  | CLASSROOM SECURITY            |          |                   |
| GR  | CLASSROOM SECURITY w/HOLDBACK |          |                   |
| WW  | INSTITUTION                   | F30      |                   |
| <b>KEYED DOUBLE CYLINDER, WITH DEADBOLT</b> |                               |          |                   |
| AC  | ENTRANCE                      | F35      | 617               |
| C   | STOREROOM                     | F14      |                   |
| FC  | INTRUDER DEADBOLT             | F34      |                   |
| FA  | DORMITORY                     | F11      |                   |
| FX  | DORMITORY                     | F33      |                   |
| <b>KEYLESS</b>                              |                               |          |                   |
| N   | PASSAGE                       | F01      | 490               |
| L   | BATHROOM                      | F02      | 543               |
| LF  | PRIVACY                       | F19      |                   |
| LJ  | PRIVACY                       | F22      | 596               |
| EX  | EXIT                          | F31      | 561               |

For pricing, finishes and availability, consult factory

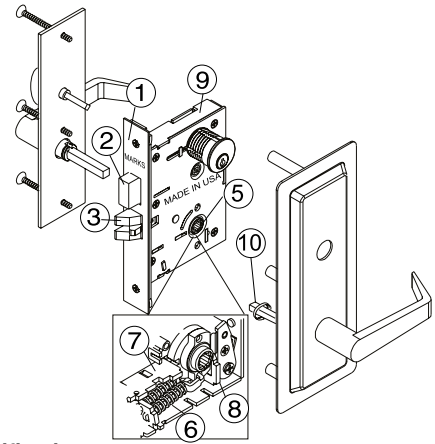

### Performance Specifications:

**Life Test:** 1,500,000 cycles minimum.

**ANSI Test:** Meets or exceeds all operational and security tests of ANSI specifications A156.13-2005 for series 1000, Grade 1.

**Fire Test:** UL Listed, 3 hour fire rated.  
Meets ADA requirements.



### Trim Specifications:

"Barrier" Thru-bolted steel lever/plate assemblies with brass machined lever bearings. Screwless forged American levers, 4-1/2" long to meet ADA requirements, fastened to plates with hardened snap rings. Spring loaded 5/16" spindles (no set screws). Dark bronze powder coated finish.

**Exterior:** Wrought steel lever/plate assembly.

10-1/8" x 4" x 5/64" with 3 concealed welded thru-posts. Center post braces lock body for proper alignment in 1-3/4" thick door. Plate covers cylinder with only the keyway exposed.

**Optional Exterior:** Plate prepared for IC core cylinder.

**Interior:** Flat steel lever/plate assembly. 10-3/4" x 3-1/8" x 3/32" thick with 3 each 1/4"-20 mounting bolts. Center bolt passes through lock body to integrate trim with lock.

**Cylinder:** 1-1/8" long, 6 pin, solid brass with spacing collar concealed under exterior "Barrier" plate; 2 keys.

**Strike:** 4-7/8" x 1-1/4" x 3/32" thick, 5/8" curved lip. Conforms to ANSI spec., A115.1.

**Door Thickness:** 1-3/4" standard. Extended range available.

### Lock Specifications: 5 Series (2-3/4" Backset)

- Lock Front:** Adjustable bevel steel backplate 1-1/4" x 8" x 7/64" thick. Cover plate 1/16" thick.
- Deadbolt:** Stainless steel w/hardened roll pins, 1" throw.
- Latch:** Solid stainless steel with antifriction latch lever, 3/4" throw (reversible).
- Auxiliary deadlatch:** 1/2" throw (reversible) - (not shown).
- Hubs:** Steel, 9/32" on diamond, 5/16" on square w/security separator.
- Independent exterior and interior lever support springs.
- Hub Follower:** (to lock hub) steel 1/8" thick.
- Hub Stop:** (to limit lever travel) steel 1/8" thick.
- Case:** Stamped steel 3/32" thick, zinc dichromate finish.
- Spindles:** Independent spring-loaded spindles, 5/16" square.

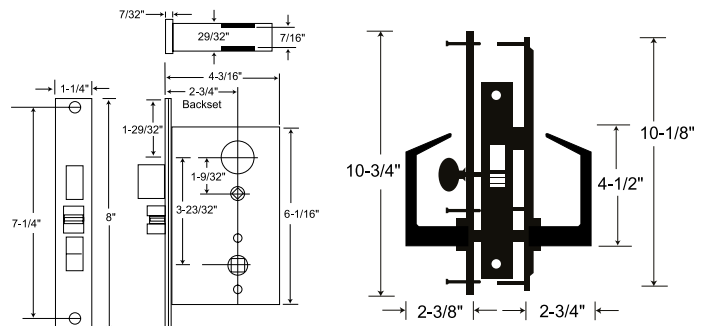

# CUSTOM LOCK DIVISION

## MAXIMUM SECURITY MORTISE LOCKSET

### Series LA318GJ

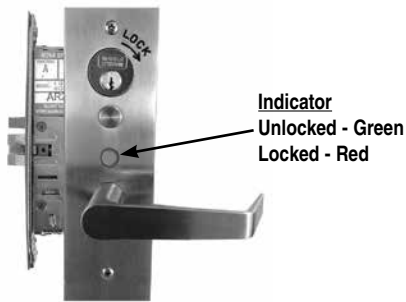

#### PERFORMANCE SPECIFICATIONS:

**LIFE TEST:** 1,500,000 cycles, minimum

**STRENGTH TEST:** 530 inch lbs. torque on exterior lever. When applied, lockset remains locked. (Torque of over 550 inch lbs. will cause spindle failure. However, lockset remains locked once spindle is replaced, lockset is fully operational.)

**ANSI TEST:** Certified to meet or exceed all operational and security tests of ANSI/BHMA A156.13-2012 for series 1000, Grade 1

**FIRE TEST:** UL listed, 3 hour fire rated. Meets ADA requirements.



**WARRANTY:** Lifetime mechanical limited warranty

All other functions available with latch, deadlatch and deadbolt combinations

#### FUNCTION SPECIFICATION: LA318GJ CLASSROOM INTRUDER

Latch by lever either side except when outside lever is locked from inside or outside by key. When locked, exterior key will retract latchbolt. Outside key locks or unlocks exterior lever. Inside key is single acting in one direction and will lock exterior lever only; will not unlock exterior lever. Auxiliary latch deadlocks latch. Inside always free for egress

**TRIM:** Cast satin stainless steel escutcheon 8-1/2"x2-3/4"x7/16". Recess in escutcheon to accept cylinder with rotating security cylinder ring. Cast screwless satin stainless steel lever handles to within 1/2" from face of door secured to escutcheon plate with hardened steel retainer ring. Lever handle, with spring-loaded torque sensitive 5/16" spindle. Integral torque override preventer recessed into escutcheon plate. Spindle will yield if excessive torque applied, preventing any damage to lock body.

**EXTERIOR:** Two 1/4" diameter threaded thru posts.

Two 1/4" diameter center posts pass thru lock body, automatically aligning trim.

**INTERIOR:** Two #10-32 phillips head stainless steel mounting thru bolts. Escutcheon with "LOCK" and directional arrow engraved and black filled near cylinder location. Occupancy indicator recessed into escutcheon plate. Indicator window to display unlocked (green day-glo) and LocDown™ (red day-glo) positions.

**CYLINDERS:** Two 1-1/8", 6-pin solid brass with 2101 cam int., 2105 cam ext., with two keys. Outside cylinder rotates in both directions. Inside cylinder rotates in one direction only. Cams supplied to accommodate Corbin™, Sargent™ and Schlage™ cylinders.

**STRIKE:** 4-7/8" X 1-1/4" X 3/32" thick, 5/8" curved lip.

Conforms to ANSI spec. 115.1.

**DOOR THICKNESS:** 1-3/4"

**Lock Body:** 5 series "GJ" function double cylinder lock. Lock handing completely reversible without opening lock case.

1. Lock Front – Adjustable bevel steel backplate 1 1/4" x 8 x 7/64" thick. Cover plate 1/16" thick, with phillips screws
2. Latch – solid stainless steel w/ antifriction latch lever 3/4" throw
3. Auxiliary Deadlatch – 1/2" throw
4. Case – stamped steel 3/32" thick
5. Hubs – Steel, 9/32" on diamond, 5/16" on square w/ security separator
6. Independent exterior and interior lever support springs

| LA318                                       |                               |          | FINISH GROUPS |
|---|-------------------------------|----------|---------------|
| MARKS #                                     | FUNCTION                      | ANSI #   | 32D           |
| <b>KEYED SINGLE CYLINDER, NO DEADBOLT</b>   |                               |          |               |
| D   | OFFICE VESTIBULE              |          | 830           |
| DW  | VESTIBULE                     |          |               |
| E   | OFFICE                        | F04      |               |
| EW  | STOREROOM                     | F07      |               |
| GL  | INST. PRIVACY                 | F26      |               |
| J   | CLASSROOM                     | F05      |               |
| JM, JR                                      | HOSPITAL (HOLDBACK)           | F06      | 1143          |
| EL  | ELECTRICALLY LOCKED           |          |               |
| EU  | ELECTRICALLY UNLOCKED         |          |               |
| <b>KEYED SINGLE CYLINDER, WITH DEADBOLT</b> |                               |          |               |
| A   | ENTRANCE                      | F08, F10 | 844           |
| B   | ENTRANCE                      | F21      |               |
| F   | DORMITORY                     | F12      |               |
| FS  | DORMITORY                     |          |               |
| FW  | DORMITORY                     | F13      |               |
| FD  | APARTMENT                     | F20      | 866           |
| H   | HOTEL                         | F15      |               |
| LH  | SPEC. PRIVACY                 |          |               |
| <b>KEYED DOUBLE CYLINDER, NO DEADBOLT</b>   |                               |          |               |
| G   | ENTRANCE                      | F09      | 876           |
| GC  | INTRUDER LATCHBOLT            | F32      |               |
| GG  | CLASSROOM SECURITY            |          |               |
| GR  | CLASSROOM SECURITY w/HOLDBACK |          |               |
| WW  | INSTITUTION                   | F30      | 900           |
| GJ  | CLASSROOM SECURITY            |          |               |
| <b>KEYED DOUBLE CYLINDER, WITH DEADBOLT</b> |                               |          |               |
| AC  | ENTRANCE                      | F35      | 890           |
| C   | STOREROOM                     | F14      |               |
| FC  | INTRUDER DEADBOLT             | F34      |               |
| FA  | DORMITORY                     | F11      |               |
| FX  | DORMITORY                     | F33      |               |
| <b>KEYLESS</b>                              |                               |          |               |
| N   | PASSAGE                       | F01      | 876           |
| L   | BATHROOM                      | F02      | 733           |
| LF  | PRIVACY                       | F19      |               |
| LJ  | PRIVACY                       | F22      | 844           |
| EX  | EXIT                          | F31      | 789           |
| <b>DUMMY TRIM</b>                           |                               |          |               |
| DI, DO                                      | DUMMY TRIM INSIDE/OUTSIDE     |          | 373           |
| DT  | DUMMY TRIM                    |          | 747           |

For pricing, finishes and availability, consult factory

| MARKS #         | FUNCTION                                  | List Price 32D |
|-----------------|---|----------------|
| GJ              | Classroom Security w/ Indicator Engraving | \$890          |
| OPTIONS         |   | Code Price     |
| Less Cylinders  |   | G3 -\$30       |
| IC Core Housing |   | G1 N/C         |

#### HOW TO ORDER

Series Function / Finish Option  
**LA318 GJ / 32D - G3**

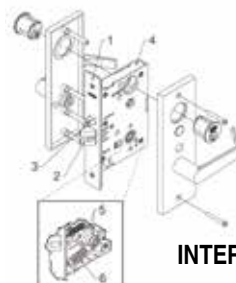

INTERIOR TRIM

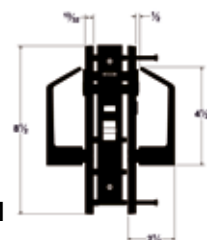

Custom Locksets



# SERIES BE101 & LA118 CUSTOM LOCK DIVISION

## MAXIMUM SECURITY MORTISE LOCKSET

| SERIES BE101 & LA118                        |                               |          | BHMA<br>CERTIFIED |            |
|---|-------------------------------|----------|-------------------|------------|
|   |                               |          | FINISH GROUPS     |            |
| MARKS #                                     | FUNCTION                      | ANSI #   | 32D               | 3, 10, 10B |
| <b>KEYED SINGLE CYLINDER, NO DEADBOLT</b>   |                               |          |                   |            |
| D   | OFFICE VESTIBULE              |          | 780               | 814        |
| DW  | VESTIBULE                     |          |                   |            |
| E   | OFFICE                        | F04      |                   |            |
| EW  | STOREROOM                     | F07      |                   |            |
| GL  | INST. PRIVACY                 | F26      |                   |            |
| J   | CLASSROOM                     | F05      |                   |            |
| JM, JR                                      | HOSPITAL (HOLDBACK)           | F06      |                   |            |
| EL  | ELECTRICALLY LOCKED           |          | 1109              | 1193       |
| EU  | ELECTRICALLY UNLOCKED         |          |                   |            |
| <b>KEYED SINGLE CYLINDER, WITH DEADBOLT</b> |                               |          |                   |            |
| A   | ENTRANCE                      | F08, F10 | 794               | 830        |
| B   | ENTRANCE                      | F21      |                   |            |
| F   | DORMITORY                     | F12      |                   |            |
| FS  | DORMITORY                     |          |                   |            |
| FW  | DORMITORY                     | F13      |                   |            |
| FD  | APARTMENT                     | F20      | 817               | 853        |
| H   | HOTEL                         | F15      |                   |            |
| LH  | SPEC. PRIVACY                 |          |                   |            |
| <b>KEYED DOUBLE CYLINDER, NO DEADBOLT</b>   |                               |          |                   |            |
| G   | ENTRANCE                      | F09      | 828               | 861        |
| GC  | INTRUDER LATCHBOLT            | F32      |                   |            |
| GG  | CLASSROOM SECURITY            |          |                   |            |
| GR  | CLASSROOM SECURITY w/HOLDBACK |          |                   |            |
| WW  | INSTITUTION                   | F30      |                   |            |
| <b>KEYED DOUBLE CYLINDER, WITH DEADBOLT</b> |                               |          |                   |            |
| AC  | ENTRANCE                      | F35      | 828               | 861        |
| C   | STOREROOM                     | F14      |                   |            |
| FC  | INTRUDER DEADBOLT             | F34      |                   |            |
| FA  | DORMITORY                     | F11      |                   |            |
| FX  | DORMITORY                     | F33      |                   |            |
| <b>KEYLESS</b>                              |                               |          |                   |            |
| N   | PASSAGE                       | F01      | 677               | 710        |
| L   | BATHROOM                      | F02      | 794               | 830        |
| LF  | PRIVACY                       | F19      |                   |            |
| LJ  | PRIVACY                       | F22      | 735               | 770        |
| EX  | EXIT                          | F31      | 735               | 770        |
| <b>DUMMY TRIM</b>                           |                               |          |                   |            |
| DI, DO                                      | DUMMY TRIM INSIDE/OUTSIDE     |          | 342               | 359        |
| DT  | DUMMY TRIM                    |          | 684               | 770        |

For pricing, finishes and availability, consult factory

| OPTIONS                           | CODE  | PRICE |
|-----------------------------------|-------|-------|
| BE 1-1/2" thick for adapter plate | A19   | 78    |
| Spacer kit for 1-1/2" thick door  | K9311 | 78    |

2 Spacer kits are needed

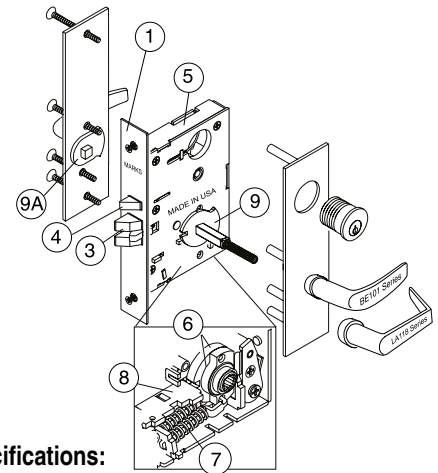

### Performance Specifications:

**Life Test:** 1,500,000 cycles minimum.

**ANSI Test:** Meets or exceeds all operational and security tests of ANSI specifications A156.13-2005 for series 1000, Grade 1.

**Fire Test:** UL Listed, 3 hour fire rated.

Meets ADA requirements.



### Trim Specifications:

"Barrier" Thru-bolted steel lever/plate assemblies with brass machined lever bearings. Screwless forged American levers, 4-1/2" long to meet ADA requirements, fastened to plates with hardened snap rings. Spring loaded 5/16" spindles (no set screws). Dark bronze powder coated finish.

**Exterior:** Wrought steel lever/plate assembly.

10-1/8" x 4" x 5/64" with 3 concealed welded thru-posts. Center post braces lock body for proper alignment in 1-3/4" thick door. Plate covers cylinder with only the keyway exposed.

**Optional Exterior:** Plate prepared for IC core cylinder.

**Interior:** Flat steel lever/plate assembly. 10-3/4" x 3-1/8" x 3/32" thick with 3 each 1/4"-20 mounting bolts. Center bolt passes through lock body to integrate trim with lock.

**Cylinder:** 1-1/8" long, 6 pin, solid brass with spacing collar concealed under exterior "Barrier" plate; 2 keys.

**Strike:** 4-7/8" x 1-1/4" x 3/32" thick, 5/8" curved lip. Conforms to ANSI spec., A115.1.

**Door Thickness:** 1-3/4" standard. Extended range available.

### Lock Specifications: 5 Series (2-3/4" Backset)

- Lock Front:** Adjustable bevel steel backplate 1-1/4" x 8" x 7/64" thick. Cover plate 1/16" thick.
- Deadbolt:** Stainless steel w/hardened roll pins, 1" throw.
- Latch:** Solid stainless steel with antifriction latch lever, 3/4" throw (reversible).
- Auxiliary deadlatch:** 1/2" throw (reversible) - (not shown).
- Hubs:** Steel, 9/32" on diamond, 5/16" on square w/security separator.
- Independent exterior and interior lever support springs.
- Hub Follower:** (to lock hub) steel 1/8" thick.
- Hub Stop:** (to limit lever travel) steel 1/8" thick.
- Case:** Stamped steel 3/32" thick, zinc dichromate finish.
- Spindles:** Independent spring-loaded spindles, 5/16" square.

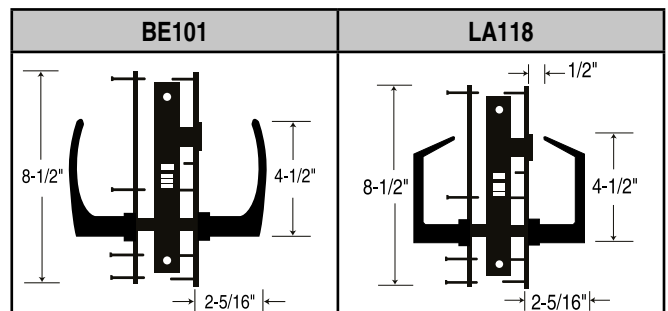

# GRADE 1 195SS LifeSaver™ CYLINDRICAL LEVERSETS

|                          |  |   |  |                     |
|--------------------------|--|---|--|---------------------|
| <b>BHMA</b><br>CERTIFIED |  | ANSI-A156.2 • Grade 1<br>3 Hour Fire Rating |  | <b>195SS SERIES</b> |
|--------------------------|--|---|--|---------------------|

| 195SS Series Leversets Shown Below | Standard Features   |
|------------------------------------|---|
|                                    | <ul style="list-style-type: none"> <li>• ANSI-A156.2 Grade 1, UL listed 3 Hr. Fire Rating</li> <li>• Backset: 2-3/4" Standard, 2-3/8", 3-3/4", 5" Available</li> <li>• Latch #1834, stainless steel nose</li> <li>• <b>Levers: Solid cast stainless steel. Levers Rotate up &amp; down freely in locked or unlocked position</b></li> <li>• Levers recessed into solid stainless steel roses eliminating any open gap</li> <li>• Roses: Thru-bolted, spring loaded, #10 thru-bolts</li> <li>• Strike: #1135, 4-7/8" ASA curved lip strike</li> <li>• Door thickness: 1-3/4" +/- 1/16"</li> <li>• Cylinder: MARKS "C" keyway, 6 pin w/ 2 keys</li> </ul> |

| SERIES 1SS19 |                       |                    |          |            |       |
|--------------|-----------------------|--------------------|----------|------------|-------|
| MARKS #      |                       | DESCRIPTION        | ANSI #   | FINISH     | PRICE |
| COMM. CYL.   | ACCEPTS IC CORE CYL.* |                    |          |            |       |
| N            | —                     | PASSAGE            | F75      | <b>32D</b> | 814   |
| L            | —                     | PRIVACY            | F76      |            | 835   |
| LK           | —                     | PRIVACY            | F76 MOD. |            | 861   |
| P            | —                     | PATIO              | F77      |            | 830   |
| DC           | RDC                   | COMMUNICATING      | F80      |            | 893   |
| A            | RA                    | ENTRY              | F81      |            | 851   |
| B            | RB                    | ENTRY              | F82A     |            | 851   |
| AB           | RAB                   | ENTRANCE           | F109     |            | 851   |
| AQ           | —                     | EXIT               | F83      |            | 840   |
| S            | RS                    | CLASSROOM          | F84      |            | 851   |
| F            | RF                    | STOREROOM          | F86      |            | 851   |
| DW           | RDW                   | INSTITUTION        | F87      |            | 893   |
| DA           | RDA                   | VESTIBULE          | F88      |            | 893   |
| FQ           | —                     | EXIT               | F89      |            | 840   |
| T            | —                     | CORRIDOR           | F90      |            | 861   |
| TK           | —                     | HOSPITAL/PRIV.     | F90 MOD. |            | 830   |
| GB           | RGB                   | STORE DOOR         | F91      |            | 861   |
| BS           | RBS                   | SVC. STATION LOCK  | F92      |            | 903   |
| DO           | —                     | DUMMY TRIM OUTSIDE | —        |            | 672   |
| DT           | —                     | FULL DUMMY TRIM    | —        |            | 772   |
| NB           | —                     | COMM. PASSAGE      | F111     | 793        |       |
| FB           | RFB                   | COMM. STOREROOM    | F112     | 845        |       |
| SB           | RSB                   | COMM. CLASSROOM    | F113     | 845        |       |

**PACKED 6 PER CASE**

Institutional Life Safety

| OPTIONS                                  | CODE | PRICE            | OPTIONS                       | CODE | PRICE |
|--|------|------------------|-------------------------------|------|-------|
| For 2" doors                             | D1   | 50               | Sargent conventional cylinder | F8   | 23    |
| For 2-1/4" doors, <b>Consult Factory</b> | D2   |                  | Corbin conventional cylinder  | F9   | 23    |
| Over 2-1/4" - 4" thickness               | D9   | 648              | Corbin 6 pin IC core          | F12  | 34    |
| 2-3/8" backset, 1" x 2-1/4" face         | E6   | NC               | Yale 6 pin IC core            | F14  | 23    |
| 5" backset, 9/16" throw, Gr. 1           | E9   | 47               | Sargent IC core               | F20  | 23    |
| 3-3/4" backset, 9/16" throw, Gr. 1       | E10  | 47               | Medeco IC core large format   | F21  | 23    |
| Less cylinder                            | G3   | <b>Deduct 15</b> |                               |      |       |
| 2-3/4" "T" strike                        | S3   | NC               |                               |      |       |

### How To Order

|                             |                             |              |                     |             |                      |
|-----------------------------|-----------------------------|--------------|---------------------|-------------|----------------------|
| <b>195SS</b>                | <b>F</b>                    | /            | <b>32D</b>          | —           | <b>G3</b>            |
| 1.<br><i>Lockset Series</i> | 2.<br><i>Marks Function</i> | <i>Slash</i> | 3.<br><i>Finish</i> | <i>Dash</i> | 4.<br><i>Options</i> |



★ **Standard & HI-SECURITY™ IC Core Models:** Interchangeable Core models for 6 or 7 pin cores (not included). **Accepts:** Marks, Marks HI-SECURITY™, Medeco®, KeyMark™, Falcon, Schlage® small format & Best®. **IC Core Tailpieces ARE Included.**



**Antimicrobial Finish Available**  
**Option Code: AM**

# SERIES 5SS55 KNOB & 5SS19 LEVER

## INSTITUTIONAL LifeSaver™ MORTISE LOCKSETS

|  |                       | <b>SERIES 5</b> |           |  |  | <b>FINISH 32D</b> |  |  |
|---|-----------------------|-----------------|-----------|---|--|-------------------|--|--|
| MARKS #   | FUNCTION              | ANSI #          | SS55 Knob | SS19 Lever  |  |                   |  |  |
| <b>KEYED SINGLE CYLINDER, NO DEADBOLT</b>   |                       |                 |           |   |  |                   |  |  |
| D   | OFFICE VEST.          |                 | 1066      | 1066  |  |                   |  |  |
| DW  | VESTIBULE             |                 |           |   |  |                   |  |  |
| E   | OFFICE                | F04             |           |   |  |                   |  |  |
| EW  | STOREROOM             | F07             |           |   |  |                   |  |  |
| J   | CLASSROOM             | F05             |           |   |  |                   |  |  |
| GL  | INSTIT. PRIVACY       | F26             |           |   |  |                   |  |  |
| EL  | ELECTRICALLY LOCKED   |                 | 1377      | 1377  |  |                   |  |  |
| EU  | ELECTRICALLY UNLOCKED |                 |           |   |  |                   |  |  |
| <b>KEYED SINGLE CYLINDER, WITH DEADBOLT</b>                                       |                       |                 |           |   |  |                   |  |  |
| A   | ENTRANCE              | F08, F10        | 1239      | 1239  |  |                   |  |  |
| B   | ENTRANCE              | F21             |           |   |  |                   |  |  |
| F   | DORMITORY             | F12             |           |   |  |                   |  |  |
| FS  | DORMITORY             |                 |           |   |  |                   |  |  |
| FW  | DORMITORY             | F13             |           |   |  |                   |  |  |
| <b>KEYED DOUBLE CYLINDER, NO DEADBOLT</b>   |                       |                 |           |   |  |                   |  |  |
| G   | APARTMENT             | F09             | 1095      | 1095  |  |                   |  |  |
| GC  | INTRUDER LATCHBOLT    | F32             |           |   |  |                   |  |  |
| GG  | CLASSROOM SECURITY    |                 |           |   |  |                   |  |  |
| WW  | INSTITUTIONAL         | F30             |           |   |  |                   |  |  |
| <b>KEYED DOUBLE CYLINDER, WITH DEADBOLT</b>                                       |                       |                 |           |   |  |                   |  |  |
| AC  | ENTRANCE              | F35             | 1095      | 1095  |  |                   |  |  |
| C   | STOREROOM             | F14             |           |   |  |                   |  |  |
| FA  | DORMITORY             | F11             |           |   |  |                   |  |  |
| FX  | DORMITORY             | F33             |           |   |  |                   |  |  |
| <b>KEYLESS</b>  |                       |                 |           |   |  |                   |  |  |
| N   | PASSAGE               | F01             | 1027      | 1027  |  |                   |  |  |
| L   | BATHROOM              | F02             | 1221      | 1221  |  |                   |  |  |
| LF  | PRIVACY               | F19             |           |   |  |                   |  |  |
| LJ  | PRIVACY               | F22             | 1250      | 1250  |  |                   |  |  |
| EX  | EXIT                  | F31             |           |   |  |                   |  |  |
| <b>DUMMY TRIM</b>   |                       |                 |           |   |  |                   |  |  |
| DI  | DUMMY TRIM INSIDE     |                 | 567       | 567   |  |                   |  |  |
| DO  | DUMMY TRIM OUTSIDE    |                 |           |   |  |                   |  |  |
| DT  | FULLY DUMMY           |                 | 1131      | 1131  |  |                   |  |  |

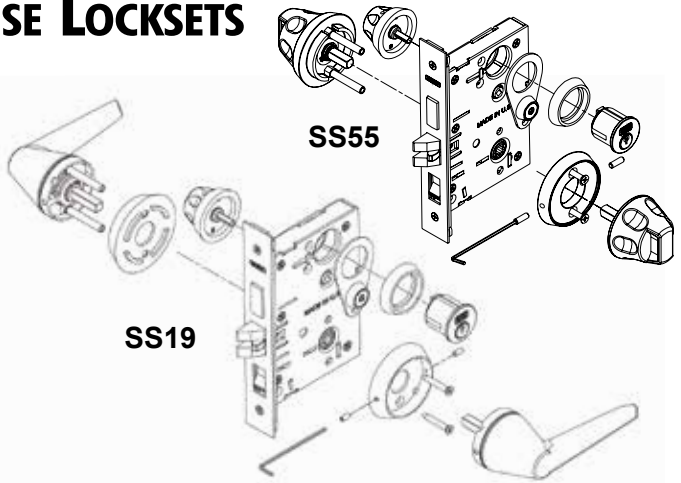

### Performance Specifications:

**Life Test:** 1,500,000 cycles minimum.

**ANSI Test:** Meets or exceeds all operational and security tests of ANSI specifications A156.13-2005 for series 5000, Grade 1.

### Trim Specifications:

#### Exterior & Interior Trim:

- Solid stainless steel interior and exterior tapered knobs or levers recessed into thru-bolted roses.
- Safety knobs with recessed grip and finger indents (*Patent #D587556*).
- Safety lever for handicapped access on clutch operated Mortise lock.
- Ergonomically designed grooved turn knob for deadbolt functions.

**Cylinder:** Solid stainless steel cylinders with solid stainless steel security collars; Optional HI-SECURITY™ cylinders available

**Strike:** 4-7/8" curved lip stainless steel w/tamperproof screws

**Door Thickness:** 1-3/4" standard; Extended range available

**Door Prep:** ANSI A115.1 lock face cutout, with 2-1/8" through hole for knob/rose assembly

### Lock Specifications: 5 Series (2-3/4" Backset) 55 Series (2-1/2" Backset)

**Lock Front:** Adjustable bevel steel backplate 1-1/4" x 8" x 7/64" thick, Cover plate 1/16" thick with tamper proof screws

**Latch:** Solid stainless steel with antifinger latch lever, 3/4" throw (reversible)

**Levers:** Solid cast stainless steel. **Levers Rotate up & down freely in locked or unlocked position**

**Aux. Deadlatch:** 1/2" throw, (reversible)

**Case:** Stamped steel 3/32" thick, zinc dichromate finish

**Hubs:** Steel, 9/32" on diamond, 5/16" on square w/security separator

**Hub Lock Arm:** (to lock hub) Steel 1/8" thick

**Spindles:** Independent spring-loaded spindles

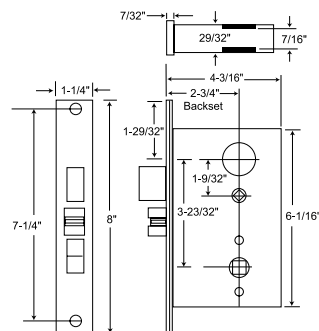

**Antimicrobial Finish Available**  
Option Code: AM

**Quick Privacy Access**  
A9618-1 Shown;  
Option Code A25



★ **Standard & HI-SECURITY™ IC Core Models:**   
Interchangeable Core models for 6 or 7 pin cores (not included).  
**Accepts:** Marks, Marks HI-SECURITY™, Medeco®, KeyMark™, Falcon, Schlage® small format & Best®. **IC Core Tailpieces ARE Included.**

| How To Order      |                   |          |         |           |            |    |
|-------------------|-------------------|----------|---------|-----------|------------|----|
| 5SS55 Knob        | 5SS19 Lever       | J        | /       | 32D       | —          | G3 |
| 1. Lockset Series | 2. Marks Function | 3. Slash | 4. Dash | 5. Finish | 6. Options |    |

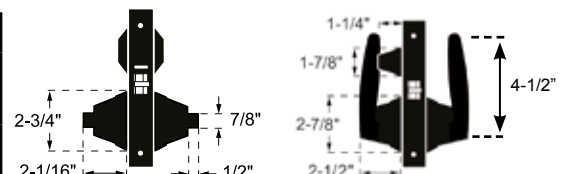

Institutional Life Safety



# SERIES 180SS INSTITUTIONAL LifeSaver™ LOCKSETS

## INSTITUTIONAL LIFE SAFETY CYLINDRICAL KNOBSETS & LOCKSETS

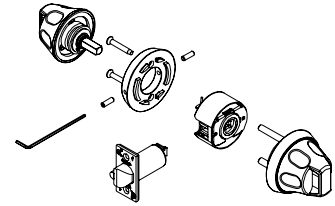

| SERIES 1SS55                                |                 |        | FINISH GROUPS |
|---|-----------------|--------|---------------|
| MARKS #                                     | FUNCTION        | ANSI # | 32D           |
| <b>KEYED SINGLE CYLINDER, WITH DEADBOLT</b> |                 |        |               |
| K   | CYLINDER x KNOB | E0121  | 1073          |
| <b>KEYLESS</b>                              |                 |        |               |
| N   | PASSAGE         | F75    | 1042          |

★ **Standard & HI-SECURITY™ IC Core Models:**   
 Interchangeable Core models for 6 or 7 pin cores (not included).  
**Accepts:** Marks, Marks HI-SECURITY™, Medeco®, KeyMark™, Falcon, Schlage® small format & Best®. **IC Core Tailpieces ARE Included.**

**180SSK: Function E0121;** Latch by knob inside, key outside.

**180SSN: Function F75;** Latch by knob either side, always open.

**Antimicrobial Finish Available**  
**Option Code: AM**

### Performance Specifications

**Life Test:** 1,500,000 cycles minimum.  
**ANSI Test:** Meets or exceeds all operational and security tests of ANSI specifications A156.2-2003 for series 1000, Grade 1.

**Fire Test:** UL Listed, 3 Hour fire rated. 

### Exterior & Interior Trim:

- Solid stainless steel interior and exterior tapered knobs recessed into thru-bolted roses
- Specially designed finger indented safety knobs with recessed grip and ergonomically designed integral grooved turn knob for elderly and handicapped access (Patent #D587556)
- Needle bearings ensure smoothness of operation

### 1SS55K Cylindrical Deadlatch Lockset: ANSI E0121 Cylinder x Knob

**Strike:** #1136, 2-3/4" "T" strike; #1135 4-7/8" ASA strike optional  
**Door Prep:** ANSI 115.2  
**Latch:** ANSI 156.2, Grade 1, 3 Hour fire rated  
**Door Thickness:** 1-3/4"  
**Backset:** 2-3/4" Backset; 3-3/4" and 5" backsets also available  
**Latch Face:** 1-1/8" x 2-1/4" with tamper proof screws  
**Cylinder:** Solid brass cylinder, 6-pin, "C" keyway; Optional HI-SECURITY™ cylinders available

### 1SS55N Cylindrical Lockset: ANSI F75 Passage

**Strike:** #1136, 2-3/4" "T" strike  
**Door Prep:** ANSI 115.2  
**Latch:** ANSI 156.2, Grade 1, 3 Hour fire rated  
**Backset:** 2-3/4" backset standard, 2-3/8" backset optional; 3-3/4" and 5" backsets also available  
**Latch Face:** 1-1/8" x 2-1/4" with tamper proof screws  
**Latch Throw:** 9/16"

# SERIES 31SS55 INSTITUTIONAL LifeSaver™ LOCKSETS

## INSTITUTIONAL LIFE SAFETY MORTISE DEADLOCK

| SERIES 31SS55                               |                 |        |  FINISH GROUPS |
|---|-----------------|--------|---|
| MARKS #                                     | FUNCTION        | ANSI # | 32D   |
| <b>KEYED SINGLE CYLINDER, WITH DEADBOLT</b> |                 |        |   |
| K   | CYLINDER x KNOB | E06071 | 447   |
| S   | CLASSROOM       | E06091 | 476   |

**31SS55K: Function E06071;** Deadbolt by outside key. Interior safety knob will retract but not project deadbolt.

**31SS55S: Function E06091;** Deadbolt by outside key. Turnpiece will retract but not project deadbolt.

### Performance Specifications:

**Life Test:** 1,500,000 cycles minimum.  
**ANSI Test:** Meets or exceeds all operational and security tests of ANSI/BHMA Certified A156.5-2001 for series 31, Grade 1.

**Fire Test:** UL Listed, 3 Hour fire rated. 

### Trim Specifications:

**Interior Trim:** Solid stainless steel interior trim including finger indented safety knobs which recess into solid brass through-bolted roses.

### Series 31 Deadlock Specifications:

**Backset:** 2-3/4"  
**Bolt throw:** 1" stainless steel w/hardened roll pins  
**Case:** Stamped Steel  
**Front:** 1-1/16" x 4-5/8" adjustable bevel  
**Cylinder:** Solid brass cylinder, 6-pin, "C" keyway, 2 keys. Optional HI-SECURITY™ cylinders available.  
**Strike:** #4035 Included

**Antimicrobial Finish**  
**Option Code: AM**

★ **Standard & HI-SECURITY™ IC Core Models:**   
 Interchangeable Core models for 6 or 7 pin cores (not included).  
**Accepts:** Marks, Marks HI-SECURITY™, Medeco®, KeyMark™, Falcon, Schlage® small format & Best®. **IC Core Tailpieces ARE Included.**

# SERIES 180PD & 5PD HOSPITAL LifeSaver™ LOCKSETS

## CYLINDRICAL & MORTISE PUSH/PULL PADDLESETS

| Hospital Push/Pull Standard Features                      |          |   |   |
|---|----------|---|---|
| • 1-3/4" door thickness, self adjusting for thicker doors |          | • Non-Handed  |   |
| • Variable mounting positions                             |          | • Easily reversible configuration for push or pull styles                         |   |
| 180PD Cylindrical Standard Features                       |          | SERIES 180PD • ANSI-A156.2 • Grade 1  |   |
| • 2-3/4" backset std., 2-3/8", 3-3/4" & 5" optional       |          |  | <b>LEAD LINING &amp; ENGRAVING AVAILABLE</b>                    |
| • 2-3/4" "T" strike; 4-7/8" ASA strike optional           |          |   |   |
| • Government standard #161 door prep                      |          |   |   |
| MARKS #   | FUNCTION | ANSI #  | FINISH: 32D Standard<br>Consult Factory for Additional Finishes |
| N   | PASSAGE  | F75   | <b>318</b>  |
| <b>PUSH/PULLS ARE PACKED 6 PER CASE</b>                   |          |   |   |

| 5PD, 55PD Mortise Standard Features                      |          | SERIES 5PD, 55PD • ANSI-A156.13 • Grade 1   |   |
|--|----------|---|---|
| • 5 Series Backset: 2-3/4";<br>55 Series Backset: 2-1/2" |          |  | <b>LEAD LINING &amp; ENGRAVING AVAILABLE</b>                    |
| • Strike: #9035, 4-7/8" ASA curved lip strike            |          |   |   |
| MARKS #  | FUNCTION | ANSI #  | FINISH: 32D Standard<br>Consult Factory for Additional Finishes |

| KEYED SINGLE CYLINDER, NO DEADBOLT |                       |     |             |
|------------------------------------|-----------------------|-----|-------------|
| D                                  | OFFICE VEST.          |     | <b>735</b>  |
| DW                                 | VESTIBULE             |     |             |
| E                                  | OFFICE                | F04 |             |
| EW                                 | STOREROOM             | F07 |             |
| J                                  | CLASSROOM             | F05 |             |
| JM, JR                             | HOSPITAL              | F06 |             |
| GL                                 | INSTITUTIONAL PRIVACY | F26 | <b>1064</b> |
| EL                                 | ELECTRICALLY LOCKED   |     |             |
| EU                                 | ELECTRICALLY UNLOCKED |     |             |

| KEYED SINGLE CYLINDER, WITH DEADBOLT |                 |          |            |
|--------------------------------------|-----------------|----------|------------|
| A                                    | ENTRANCE        | F08, F10 | <b>750</b> |
| B                                    | ENTRANCE        | F21      |            |
| F                                    | DORMITORY       | F12      |            |
| FS                                   | DORMITORY       |          | <b>773</b> |
| FW                                   | DORMITORY       | F13      |            |
| FD                                   | APARTMENT       | F20      |            |
| H                                    | HOTEL           | F15      |            |
| LH                                   | SPECIAL PRIVACY |          |            |

| KEYED DOUBLE CYLINDER, NO DEADBOLT |                                   |     |            |
|------------------------------------|-----------------------------------|-----|------------|
| G                                  | APARTMENT                         | F09 | <b>783</b> |
| GC                                 | INTRUDER LATCHBOLT                | F32 |            |
| GG                                 | CLASSROOM SECURITY                |     |            |
| GR                                 | CLASSROOM SECURITY w/<br>HOLDBACK |     |            |
| WW                                 | INSTITUTIONAL                     | F30 |            |

| KEYED DOUBLE CYLINDER, WITH DEADBOLT |                   |     |            |
|--------------------------------------|-------------------|-----|------------|
| AC                                   | ENTRANCE          | F35 | <b>783</b> |
| C                                    | STOREROOM         | F14 |            |
| FC                                   | INTRUDER DEADBOLT | F34 |            |
| FA                                   | DORMITORY         | F11 |            |
| FX                                   | DORMITORY         | F33 |            |

| KEYLESS |          |     |            |
|---------|----------|-----|------------|
| N       | PASSAGE  | F01 | <b>633</b> |
| L       | BATHROOM | F02 | <b>750</b> |
| LF      | PRIVACY  | F19 | <b>688</b> |
| LJ      | PRIVACY  | F22 |            |
| EX      | EXIT     | F31 |            |

| How To Order                |                             |              |                     |             |                      |
|-----------------------------|-----------------------------|--------------|---------------------|-------------|----------------------|
| <b>5PD or 180PD</b>         | <b>F</b>                    | <b>/</b>     | <b>32D</b>          | <b>—</b>    | <b>G3</b>            |
| 1.<br><i>Lockset Series</i> | 2.<br><i>Marks Function</i> | <i>Slash</i> | 3.<br><i>Finish</i> | <i>Dash</i> | 4.<br><i>Options</i> |

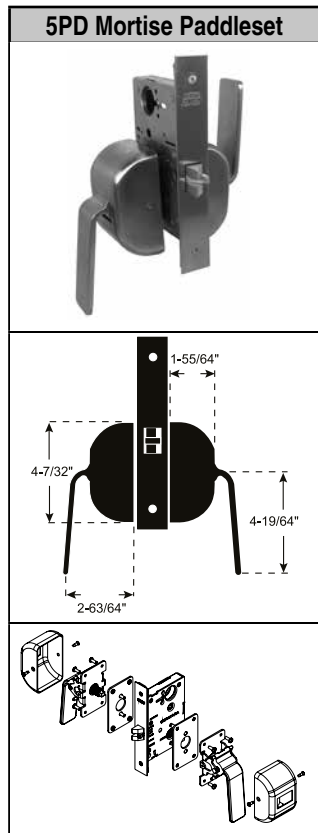
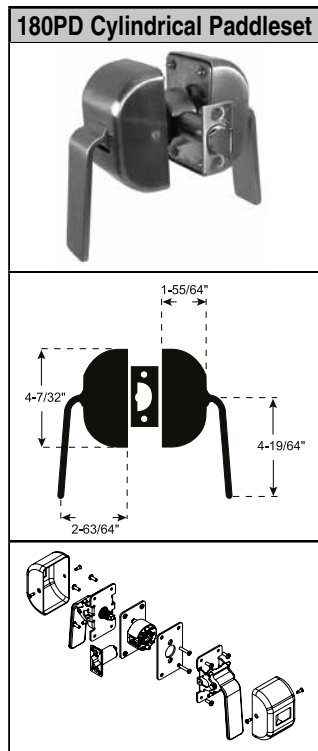

Hospital Push/Pull Paddlesets

# MORTISE LOCK CYLINDERS

## Cylinders

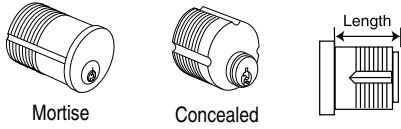

## IC Core Cylinder Housings

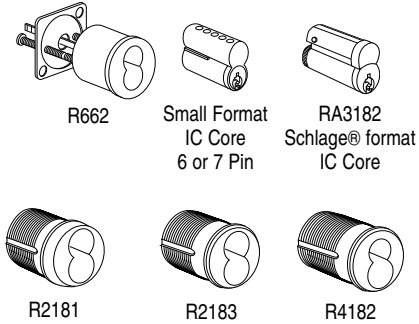

IC core pricing includes KA, KD or MK keying.

**\* Standard & HI-SECURITY™ IC Core Models:**   
 Interchangeable Core models for 6 or 7 pin cores (not included).  
**Accepts:** Marks, Marks HI-SECURITY™, Medeco®, KeyMark™, Falcon, Schlage® small format & Best®. **IC Core Tailpieces ARE Included.**

| PART #   | DESCRIPTION                       | PINS   | LENGTH | FINISH GROUPS |                         |     |
|----------|-----------------------------------|--------|--------|---------------|-------------------------|-----|
|          |                                   |        |        | 3, 26D        | 5, 10, 10B, 15, 26, 32D | 3E  |
| 2122     | Mortise                           | 5      | 15/16" | 49            | 51                      | 71  |
| 2181     | Mortise                           | 6      | 2-7/8" | 422           | —                       | —   |
| 2182     | Mortise                           | 6      | 1-1/8" | 53            | 59                      | 74  |
| 2183     | Mortise                           | 6      | 1-1/4" | 53            | 59                      | 74  |
| 2193     | Concealed                         | 5      | 15/16" | 71            | —                       | —   |
| 2194     | Concealed                         | 6      | 1-1/8" | 75            | —                       | —   |
| 2196     | Mortise                           | 6      | 2-3/8" | 294           | —                       | —   |
| 2197     | Mortise                           | 6      | 1-3/4" | 114           | 119                     | 134 |
| 2198     | Mortise                           | 6      | 1-1/2" | 91            | 94                      | 114 |
| 662      | Rim                               | 6      | —      | 53            | 59                      | —   |
| * R2181  | Mortise IC Core Housing           | 6      | 1"     | 53            | 59                      | —   |
| * R2182  | Mortise IC Core Housing           | 6      | 1-1/4" | 49            | 51                      | —   |
| * R2183  | Mortise IC Core Housing           | 6 or 7 | 1-3/8" | 49            | 51                      | —   |
| * R2184  | IC Core Cylinder Housing          | 6 or 7 | 1-3/4" | 113           | 113                     | 113 |
| * R3182  | Schlage® type IC Core, Uncombined | 6      | —      | 113           | —                       | —   |
| * R4182  | Schlage® type IC Core Housing     | 6      | 1-1/2" | 134           | —                       | —   |
| * R662   | Rim IC Core Housing               | 6 or 7 | 1-3/8" | 56            | 59                      | —   |
| * R1182  | 6 Pin Core, Uncombined            | —      | —      | 43            | —                       | —   |
| * R1183  | 7 Pin Core, Uncombined            | —      | —      | 43            | —                       | —   |
| * RA1182 | 6 Pin Core, Combined              | —      | —      | 63            | 65                      | —   |
| * RA1183 | 7 Pin Core, Combined              | —      | —      | 63            | 65                      | —   |
| * RA3182 | Schlage® type IC Core, Combined   | 6      | —      | 134           | —                       | —   |
| * RC1182 | 6 Pin Core, Construction Core     | —      | —      | 45            | —                       | —   |
| * RC1187 | Plastic Core Turn Knob            | —      | —      | 8             | —                       | —   |
| * RC3182 | Schlage® type Construction Core   | —      | —      | 113           | —                       | —   |
| RM1182   | Marketry Core                     | —      | —      | 47            | —                       | —   |

## Cylinder Cams



| PART # | DESCRIPTION    | USE WITH MORTISE LOCK | CODE  | PRICE |
|--------|----------------|-----------------------|-------|-------|
| 2101   | STRAIGHT CAM   | MARKS                 | 1     | 6     |
| 2101-A |                | ARROW/SARGENT         | A1    | 6     |
| 2101-C |                | CORBIN RUSSWIN        | C1    | 6     |
| 2101-S |                | SCHLAGE               | S1    | 6     |
| 2102   |                | CLOVERLEAF CAM        | MARKS | 2     |
| 2102-A | ARROW/SARGENT  |                       | A2    | 6     |
| 2102-C | CORBIN RUSSWIN |                       | C2    | 6     |
| 2102-S | SCHLAGE        |                       | S2    | 6     |

| PART #  | DESCRIPTION              | USE WITH MORTISE LOCK | CODE  | PRICE |
|---------|--------------------------|-----------------------|-------|-------|
| 2104    | ADAMS-RITE CAM           | MARKS                 | 4     | 6     |
| 2105    | "J" FUNCTION CAM         | MARKS                 | 5     | 6     |
| 2105-A  |                          | ARROW/SARGENT         | A5    | 6     |
| 2105-C  |                          | CORBIN RUSSWIN        | C5    | 6     |
| 2105-S  |                          | SCHLAGE               | S5    | 6     |
| 2107-CL |                          | "J-CL" FUNCTION CAM   | MARKS | 7     |
| 2106    | "G" CAM<br>Exterior only | MARKS                 | 6     | 6     |
| 2106-A  |                          | ARROW/SARGENT         | A6    | 6     |
| 2106-C  |                          | CORBIN RUSSWIN        | C6    | 6     |
| 2106-S  |                          | SCHLAGE               | S6    | 6     |

Mortise Cylinders, Parts, Cams

## How To Order Example for Mortise Lock Cylinders

|                |       |              |      |               |
|----------------|-------|--------------|------|---------------|
| <b>2182</b>    | /     | <b>32D</b>   | —    | <b>1C</b>     |
| 1.<br>Cylinder | Slash | 2.<br>Finish | Dash | 3.<br>Options |

See List Of Cylinders Available

FINISH (Pg. 8)

- |                             |                              |                              |
|-----------------------------|------------------------------|------------------------------|
| <input type="checkbox"/> 3  | <input type="checkbox"/> 10  | <input type="checkbox"/> 26  |
| <input type="checkbox"/> 3E | <input type="checkbox"/> 10B | <input type="checkbox"/> 26D |
| <input type="checkbox"/> 5  | <input type="checkbox"/> 15  | <input type="checkbox"/> 32D |

Special

Specify

- Keying
- Door Thickness

Cam and keying information must be included in the option section.

# KEYS & KEYING

## Keys

Can Stamp A Maximum Of 6 Characters On Key.

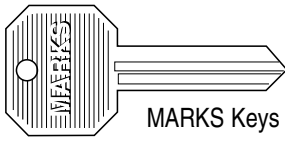

MARKS Keys

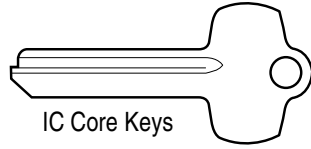

IC Core Keys

| STANDARD KEYWAYS | PIN LENGTH ACCEPTS          | SHOULDER INCREMENTS | PIN TO PIN TO 1st PIN | PLUG DISTANCE | DIAMETER |
|------------------|-----------------------------|---------------------|-----------------------|---------------|----------|
| MARKS "A"        | Arrow<br>Kwikset<br>Segal 9 | .015"               | .264"                 | .156"         | .504"    |
| MARKS "C"        | Schlage "C"                 | .015"               | .231"                 | .156"         | .504"    |

## Construction Master Keying:

The construction master key (CMK) is to be used temporarily while the building is under construction. When construction is completed, the end user defeats the CMK's operation by turning the change key in each cylinder, rather than replace or re-keying the cylinder.

Marks USA uses a program which is called the "lost ball" program. When construction key system is set up, three small ball bearings (construction balls) are placed between the bottom pin and master pin, normally in the last chamber as a "temporary master pin". The construction key is usually the same cut as the top master key with the exception of the sixth cut which is two increments higher. The construction master key will work in any cylinder until cylinder is "defeated" by making one full rotation in the cylinder with the change key. The cylinder plug requires a small diameter "pocket" drilled on one side of one pin chamber so when rotating the cylinder with the change key the pocket will capture the construction balls. The construction pocket in the plug is smaller than a pin chamber. This prevents any top pins or master pins from entering as the plug rotates. Once the cylinder is defeated, there is no way for the cylinder to be construction keyed again without disassembling it.

| PART # | DESCRIPTION                          | PRICE |     |
|--------|--------------------------------------|-------|-----|
|        |                                      | BLANK | CUT |
| 2164A  | MARKS "A" 5 PIN BRASS                | 5     | 7   |
| 2164C  | MARKS "C" 5 PIN BRASS, NICKEL PLATED | 5     | 7   |
| 2184A  | MARKS "A" 6 PIN NICKEL SILVER        | 6     | 8   |
| 2184C  | MARKS "C" 6 PIN NICKEL SILVER        | 6     | 6   |
| 2185C  | MARKS "C" 6 PIN LARGE BOW            | 8     | 9   |
| R1164  | IC CORE 6 OR 7 PIN (SMALL FORMAT)    | 6     | 8   |
| R3164  | SCHLAGE® IC CORE CONTROL KEY         | 6     | 8   |

BEST® A thru M keyway. Please specify.  
IC Core pricing includes KA, KD or MK Keying.

| PART #                           | DESCRIPTION                                       | PRICE          |         |
|----------------------------------|---|----------------|---------|
|                                  |   | REGULAR        | IC CORE |
| KA                               | KEYED ALIKE                                       | NC             | NC      |
| KD                               | KEYED DIFFERENT                                   | NC             | NC      |
| MK                               | MASTER KEYED                                      | 21             | NC      |
| CMK                              | CONSTRUCTION MASTER KEYED<br>(Includes GMK or MK) | 31             | —       |
| GMK                              | GRAND MASTER KEYED                                | 21             | 13      |
| GGMK                             | GREAT GRAND MASTER KEYED                          | 21             | 13      |
| GGGMK                            | GREAT GREAT GRAND MASTER KEYED                    | 21             | —       |
| HK                               | HOTEL KEYED (Guest, Maid, Emergency)              | 28             | —       |
| KEYING TO A SPECIFIC CODE NUMBER |   | 15             | 15      |
| STAMPING                         |   | PRICE          |         |
| LETTERS/NUMBERS ON KEY           |   | 7 PER KEY      |         |
| US PROPERTY - "DO NOT DUPLICATE" |   | 7 PER KEY      |         |
| VISUAL KEY CONTROL (VKC)         |   | 6              |         |
| CONCEAL KEY CONTROL              |   | 15             |         |
| EXTRA CUT KEYS WITH LOCKSET      |   | SEE KEYS ABOVE |         |
| LARGE BOW KEY                    |   | 7 PER KEY      |         |
| KEY BITTING CODE LIST            |   | 252            |         |

IC CORE PRICING INCLUDES KA, KD OR MK KEYING

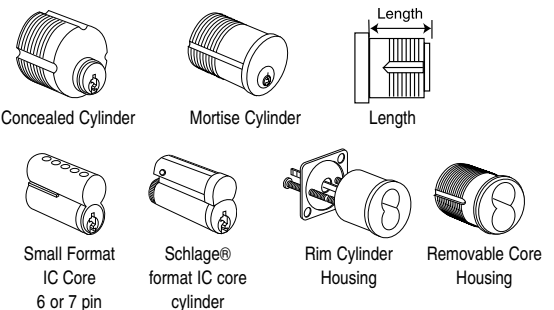
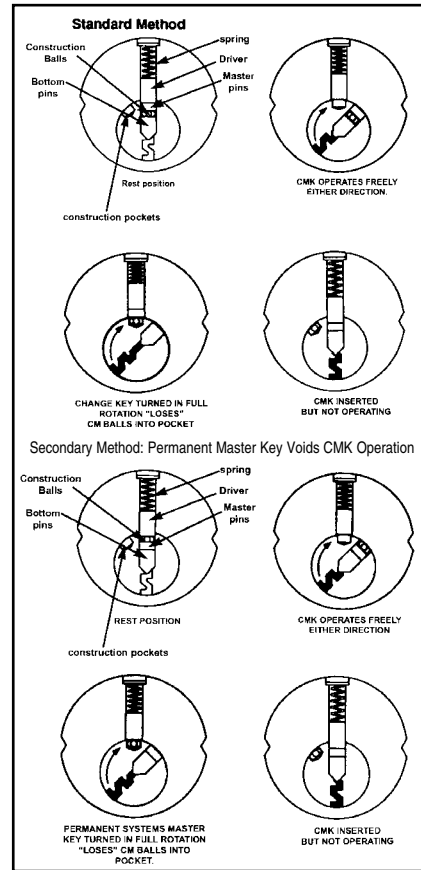

### \* Standard & HI-SECURITY™ IC Core Models:

Interchangeable Core models for 6 or 7 pin cores (not included).

Accepts: Marks, Marks HI-SECURITY™, Medeco®, KeyMark™, Falcon, Schlage® small format & Best®. IC Core Tailpieces ARE Included.

# HI-SECURITY™ CYLINDERS: NON-UL



| HI-SECURITY™ MORTISE CYLINDERS  |  |                         |               |                            |     |  |
|---|--|-------------------------|---------------|----------------------------|-----|--|
|  | NON-UL "0" Bitted x 2 Keys;<br>"0" Bitted "NO KEYS" - Deduct \$6 |                         | FINISH GROUPS |                            |     |  |
|   | PART #   | DESCRIPTION             | 3, 26D        | 4, 5, 10, 10B, 15, 26, 32D | 3E  |  |
|   | BXXX-D001A0N2  | 1-1/8" Mortise Cylinder | 72            | 78                         | 91  |  |
|   | CXXX-D001A0N2  | 1-1/4" Mortise Cylinder | 78            | 84                         | 97  |  |
|   | DXXX-D001A0N2  | 1-3/8" Mortise Cylinder | 90            | 95                         | 109 |  |
|   | LXXX-D001A0N2  | 1-1/2" Mortise Cylinder | 101           | 106                        | 119 |  |
|   | MXXX-D001A0N2  | 1-3/4" Mortise Cylinder | 113           | 120                        | 132 |  |
|   | NON-UL KD x 2 Keys   |                         |               |                            |     |  |
|   | BXXX-D001A1N2  | 1-1/8" Mortise Cylinder | 79            | 86                         | 101 |  |
|   | CXXX-D001A1N2  | 1-1/4" Mortise Cylinder | 86            | 90                         | 105 |  |
| DXXX-D001A1N2   | 1-3/8" Mortise Cylinder  | 98                      | 103           | 117                        |     |  |
| LXXX-D001A1N2   | 1-1/2" Mortise Cylinder  | 108                     | 113           | 128                        |     |  |
| MXXX-D001A1N2   | 1-3/4" Mortise Cylinder  | 108                     | 126           | 139                        |     |  |

HI-SECURITY™ CYLINDERS ARE PACKED 24 PER CASE

| HI-SECURITY™ MORTISE/RIM COMBO CYLINDERS  |  |                       |               |                            |     |  |
|---|--|-----------------------|---------------|----------------------------|-----|--|
|  | NON-UL "0" Bitted x 2 Keys;<br>"0" Bitted "NO KEYS" - Deduct \$6 |                       | FINISH GROUPS |                            |     |  |
|   | PART #   | DESCRIPTION           | 3, 26D        | 4, 5, 10, 10B, 15, 26, 32D | 3E  |  |
|   | EXXX-D001A0N2  | 1" Combo Cylinder     | 65            | 70                         | 85  |  |
|   | FXXX-D001A0N2  | 1-1/8" Combo Cylinder | 78            | 84                         | 97  |  |
|   | NON-UL KD x 2 Keys   |                       |               |                            |     |  |
|   | EXXX-D001A1N2  | 1" Combo Cylinder     | 73            | 78                         | 91  |  |
|   | FXXX-D001A1N2  | 1-1/8" Combo Cylinder | 86            | 90                         | 105 |  |

HI-SECURITY™ CYLINDERS ARE PACKED 24 PER CASE

| HI-SECURITY™ KIK CYLINDERS  |   |                      |               |  |
|---|---|----------------------|---------------|--|
|  | NON-UL "0" Bitted x 2 Keys; "0" Bitted "NO KEYS" - Deduct \$6 |                      | FINISH GROUPS |  |
|   | PART #  | DESCRIPTION          | 26D           |  |
|   | G26D-D001X0N2   | Key-In-Knob Cylinder | 59            |  |
|   | NON-UL KD x 2 Keys  |                      |               |  |
|   | G26D-D001X1N2   | Key-In-Knob Cylinder | 65            |  |

HI-SECURITY™ CYLINDERS ARE PACKED 24 PER CASE

| HI-SECURITY™ MARKS IC CORE CYLINDERS  |   |                        |               |  |
|---|---|------------------------|---------------|--|
|  | NON-UL "0" Bitted x 2 Keys x 1 Control Key; "0" Bitted "NO KEYS" - Deduct \$6 |                        | FINISH GROUPS |  |
|   | PART #  | DESCRIPTION            | 26D           |  |
|   | H26D-D001X0N2   | 6 Pin IC Core Cylinder | 65            |  |
|   | J26D-D001X0N2   | 7 Pin IC Core Cylinder | 68            |  |
|   | NON-UL KD x 2 Keys x 1 Control Key  |                        |               |  |
|   | H26D-D001X1N2   | 6 Pin IC Core Cylinder | 76            |  |
| J26D-D001X1N2   | 7 Pin IC Core Cylinder  | 79                     |               |  |

HI-SECURITY™ CYLINDERS ARE PACKED 24 PER CASE

| HI-SECURITY™ Schlage® LARGE FORMAT IC CORE CYLINDERS                                |   |                                 |               |  |
|---|---|---------------------------------|---------------|--|
|  | NON-UL "0" Bitted x 2 Keys x 1 Control Key; "0" Bitted "NO KEYS" - Deduct \$6 |                                 | FINISH GROUPS |  |
|   | PART #  | DESCRIPTION                     | 26D           |  |
|   | K26D-D001X0N2   | 6 Pin Schlage® IC Core Cylinder | 83            |  |
|   | NON-UL KD x 2 Keys x 1 Control Key  |                                 |               |  |
|   | K26D-D001X1N2   | 6 Pin Schlage® IC Core Cylinder | 92            |  |

HI-SECURITY™ CYLINDERS ARE PACKED 24 PER CASE

| HI-SECURITY™ Medeco® LARGE FORMAT IC CORE CYLINDERS                                 |   |                                |               |
|---|---|--------------------------------|---------------|
|  | NON-UL "0" Bitted x 2 Keys x 1 Control Key; "0" Bitted "NO KEYS" - Deduct \$6 |                                | FINISH GROUPS |
|   | PART #  | DESCRIPTION                    | 26D           |
|   | P26D-D001X0N2   | 6 Pin Medeco® IC Core Cylinder | 101           |
|   | NON-UL KD x 2 Keys x 1 Control Key  |                                |               |
| P26D-D001X1N2   | 6 Pin Medeco® IC Core Cylinder  | 112                            |               |

HI-SECURITY™ CYLINDERS ARE PACKED 24 PER CASE

HI-SECURITY™  
Cylinders

# HI-SECURITY™ CYLINDERS: UL 437



| HI-SECURITY™ MORTISE CYLINDERS  |  |                         |               |                            |     |  |
|---|--|-------------------------|---------------|----------------------------|-----|--|
|  | UL 437 "0" Bitted x 2 Keys;<br>"0" Bitted "NO KEYS" - Deduct \$6 |                         | FINISH GROUPS |                            |     |  |
|   | PART #   | DESCRIPTION             | 3, 26D        | 4, 5, 10, 10B, 15, 26, 32D | 3E  |  |
|   | BXXX-D001A0U2  | 1-1/8" Mortise Cylinder | 90            | 95                         | 109 |  |
|   | CXXX-D001A0U2  | 1-1/4" Mortise Cylinder | 92            | 98                         | 112 |  |
|   | DXXX-D001A0U2  | 1-3/8" Mortise Cylinder | 108           | 113                        | 128 |  |
|   | LXXX-D001A0U2  | 1-1/2" Mortise Cylinder | 114           | 123                        | 137 |  |
|   | MXXX-D001A0U2  | 1-3/4" Mortise Cylinder | 131           | 135                        | 149 |  |
|   | UL 437 KD x 2 Keys   |                         |               |                            |     |  |
|   | BXXX-D001A1U2  | 1-1/8" Mortise Cylinder | 98            | 103                        | 117 |  |
|   | CXXX-D001A1U2  | 1-1/4" Mortise Cylinder | 101           | 107                        | 119 |  |
|   | DXXX-D001A1U2  | 1-3/8" Mortise Cylinder | 116           | 120                        | 134 |  |
|   | LXXX-D001A1U2  | 1-1/2" Mortise Cylinder | 126           | 131                        | 145 |  |
| MXXX-D001A1U2   | 1-3/4" Mortise Cylinder  | 138                     | 144           | 158                        |     |  |
| <b>HI-SECURITY™ CYLINDERS ARE PACKED 24 PER CASE</b>                              |  |                         |               |                            |     |  |

| HI-SECURITY™ MORTISE/RIM COMBO CYLINDERS  |  |                       |               |                            |     |  |
|---|--|-----------------------|---------------|----------------------------|-----|--|
|  | UL 437 "0" Bitted x 2 Keys;<br>"0" Bitted "NO KEYS" - Deduct \$6 |                       | FINISH GROUPS |                            |     |  |
|   | PART #   | DESCRIPTION           | 3, 26D        | 4, 5, 10, 10B, 15, 26, 32D | 3E  |  |
|   | EXXX-D001A0U2  | 1" Combo Cylinder     | 84            | 88                         | 102 |  |
|   | FXXX-D001A0U2  | 1-1/8" Combo Cylinder | 95            | 101                        | 114 |  |
|   | UL 437 KD x 2 Keys   |                       |               |                            |     |  |
|   | EXXX-D001A1U2  | 1" Combo Cylinder     | 90            | 95                         | 109 |  |
| FXXX-D001A1U2   | 1-1/8" Combo Cylinder  | 103                   | 108           | 109                        |     |  |
| <b>HI-SECURITY™ CYLINDERS ARE PACKED 24 PER CASE</b>                              |  |                       |               |                            |     |  |

| HI-SECURITY™ KIK CYLINDERS  |   |                      |               |
|---|---|----------------------|---------------|
|  | UL 437 "0" Bitted x 2 Keys; "0" Bitted "NO KEYS" - Deduct \$6 |                      | FINISH GROUPS |
|   | PART #  | DESCRIPTION          | 26D           |
|   | G26D-D001X0U2   | Key-In-Knob Cylinder | 75            |
|   | UL 437 KD x 2 Keys  |                      |               |
| G26D-D001X1U2   | Key-In-Knob Cylinder  | 84                   |               |
| <b>HI-SECURITY™ CYLINDERS ARE PACKED 24 PER CASE</b>                                |   |                      |               |

| HI-SECURITY™ Schlage® LARGE FORMAT IC CORE CYLINDERS                                |   |                                 |               |
|---|---|---------------------------------|---------------|
|  | UL 437 "0" Bitted x 2 Keys x 1 Control Key; "0" Bitted "NO KEYS" - Deduct \$6 |                                 | FINISH GROUPS |
|   | PART #  | DESCRIPTION                     | 26D           |
|   | K26D-D001X0U2   | 6 Pin Schlage® IC Core Cylinder | 97            |
|   | NON-UL KD x 2 Keys x 1 Control Key  |                                 |               |
| K26D-D001X1U2   | 6 Pin Schlage® IC Core Cylinder   | 108                             |               |
| <b>HI-SECURITY™ CYLINDERS ARE PACKED 24 PER CASE</b>                                |   |                                 |               |

| HI-SECURITY™ Medeco® LARGE FORMAT IC CORE CYLINDERS                                 |   |                                |               |
|---|---|--------------------------------|---------------|
|  | UL 437 "0" Bitted x 2 Keys x 1 Control Key; "0" Bitted "NO KEYS" - Deduct \$6 |                                | FINISH GROUPS |
|   | PART #  | DESCRIPTION                    | 26D           |
|   | P26D-D001X0U2   | 6 Pin Medeco® IC Core Cylinder | 116           |
|   | NON-UL KD x 2 Keys x 1 Control Key  |                                |               |
| P26D-D001X1U2   | 6 Pin Medeco® IC Core Cylinder  | 128                            |               |
| <b>HI-SECURITY™ CYLINDERS ARE PACKED 24 PER CASE</b>                                |   |                                |               |

HI-SECURITY™  
Cylinders

# HI-SECURITY™ CYLINDERS





## Security-Mate™ & SPECIAL APPLICATION CYLINDERS

| Security-Mate™ MORTISE CYLINDERS  |                      |                         |               |                            |
|---|----------------------|-------------------------|---------------|----------------------------|
|  | "0" Bitted "NO KEYS" |                         | FINISH GROUPS |                            |
|   | PART #               | DESCRIPTION             | 3, 26D        | 4, 5, 10, 10B, 15, 26, 32D |
|   | BXXX-DXXXXA0N0       | 1-1/8" Mortise Cylinder | 56            | 61                         |
|   | CXXX-DXXXXA0N0       | 1-1/4" Mortise Cylinder | 61            | 65                         |
|   | DXXX-DXXXXA0N0       | 1-3/8" Mortise Cylinder | 72            | 78                         |
|   | LXXX-DXXXXA0N0       | 1-1/2" Mortise Cylinder | 84            | 49                         |
|   | MXXX-DXXXXA0N0       | 1-3/4" Mortise Cylinder | 95            | 101                        |
| <b>Security-Mate™ CYLINDERS ARE PACKED 24 PER CASE</b>                            |                      |                         |               |                            |

| Security-Mate™ MORTISE/RIM COMBO CYLINDERS  |  |                       |               |                            |
|---|--|-----------------------|---------------|----------------------------|
|  | "0" Bitted "NO KEYS"                                   |                       | FINISH GROUPS |                            |
|   | PART #   | DESCRIPTION           | 3, 26D        | 4, 5, 10, 10B, 15, 26, 32D |
|   | EXXX-DXXXXA0N0   | 1" Combo Cylinder     | 47            | 53                         |
|   | FXXX-DXXXXA0N0   | 1-1/8" Combo Cylinder | 61            | 65                         |
|   | <b>Security-Mate™ CYLINDERS ARE PACKED 24 PER CASE</b> |                       |               |                            |

| Security-Mate™ KIK CYLINDERS  |                      |                      |               |
|---|----------------------|----------------------|---------------|
|  | "0" Bitted "NO KEYS" |                      | FINISH GROUPS |
|   | PART #               | DESCRIPTION          | 26D           |
|   | G26D-DXXXXX0N0       | Key-In-Knob Cylinder | 44            |
| <b>Security-Mate™ CYLINDERS ARE PACKED 24 PER CASE</b>                            |                      |                      |               |

| Security-Mate™ MARKS IC CORE CYLINDERS  |                      |                        |               |
|---|----------------------|------------------------|---------------|
|  | "0" Bitted "NO KEYS" |                        | FINISH GROUPS |
|   | PART #               | DESCRIPTION            | 26D           |
|   | H26D-DXXXXX0N0       | 6 Pin IC Core Cylinder | 49            |
|   | J26D-DXXXXX0N0       | 7 Pin IC Core Cylinder | 53            |
| <b>Security-Mate™ CYLINDERS ARE PACKED 24 PER CASE</b>                              |                      |                        |               |

| Security-Mate® Schlage™ LARGE FORMAT IC CORE CYLINDERS                              |                      |                                 |               |
|---|----------------------|---------------------------------|---------------|
|  | "0" Bitted "NO KEYS" |                                 | FINISH GROUPS |
|   | PART #               | DESCRIPTION                     | 26D           |
|   | K26D-DXXXXX0N0       | 6 Pin Schlage® IC Core Cylinder | 67            |
| <b>Security-Mate™ CYLINDERS ARE PACKED 24 PER CASE</b>                              |                      |                                 |               |

| Security-Mate® Medeco™ LARGE FORMAT IC CORE CYLINDERS                               |                      |                                |               |
|---|----------------------|--------------------------------|---------------|
|  | "0" Bitted "NO KEYS" |                                | FINISH GROUPS |
|   | PART #               | DESCRIPTION                    | 26D           |
|   | P26D-DXXXXX0N0       | 6 Pin Medeco® IC Core Cylinder | 86            |
| <b>Security-Mate™ CYLINDERS ARE PACKED 24 PER CASE</b>                              |                      |                                |               |

| HI-SECURITY™ SPECIAL APPLICATION CYLINDERS  |   |                          |        |               |  |
|---|---|--------------------------|--------|---------------|--|
|  | KA Pair w/ 2 Keys, NON-UL, Straight Cam |                          |        | FINISH GROUPS |  |
|   | PART #                                  | DESCRIPTION              | 3, 26D | 5, 15         |  |
|   | 2122XXXHSM                              | 15/16" Mortise Cylinders | 141    | 146           |  |
| <b>HI-SECURITY™ SPECIAL APPLICATION CYLINDERS ARE PACKED 24 PER CASE</b>            |   |                          |        |               |  |

HI-SECURITY™  
Cylinders

# HI-SECURITY™ CYLINDERS

## HOW TO ORDER HI-SECURITY™ CYLINDERS AND KEYS

| How To Order Example<br>for HI-SECURITY™ Cylinders |                     |             |                     |                            |                       |                     |                             |                        |
|--|---------------------|-------------|---------------------|----------------------------|-----------------------|---------------------|-----------------------------|------------------------|
| <b>D</b>   | <b>3</b>            | —           | <b>D</b>            | <b>001</b>                 | <b>A</b>              | <b>3</b>            | <b>U</b>                    | <b>2</b>               |
| 1.<br><i>Cylinder Type</i>                         | 2.<br><i>Finish</i> | <i>Dash</i> | 3.<br><i>Keyway</i> | 4.<br><i>Security Code</i> | 5.<br><i>Cam Tail</i> | 6.<br><i>Keying</i> | 7.<br><i>NON-UL / UL437</i> | 8.<br><i># of Keys</i> |

| CYLINDER TYPE   | FINISH   | KEYWAY                          | SECURITY CODE                        | CAM TAIL<br><i>MORTISE</i>  | KEYING  | UL or<br>NON-UL  | KEYING   |
|---|--|---------------------------------|--------------------------------------|---|---|--|--|
| <input type="checkbox"/> B = 1-1/8" Mortise<br><input type="checkbox"/> C = 1-1/4" Mortise<br><input type="checkbox"/> D = 1-3/8" Mortise<br><input type="checkbox"/> L = 1-1/2" Mortise<br><input type="checkbox"/> M = 1-3/4" Mortise<br><input type="checkbox"/> E = 1" Combo<br><input type="checkbox"/> F = 1-1/8" Combo<br><input type="checkbox"/> G = KIK Cylinder<br><input type="checkbox"/> H = IC Core Marks 6 Pin<br><input type="checkbox"/> J = IC Core Marks 7 Pin<br><input type="checkbox"/> K = IC Core Schlage® Large Format<br><input type="checkbox"/> P = IC Core Medeco® Large Format | <input type="checkbox"/> 3<br><input type="checkbox"/> 4<br><input type="checkbox"/> 5<br><input type="checkbox"/> 10<br><input type="checkbox"/> 10B<br><input type="checkbox"/> 15<br><input type="checkbox"/> 26<br><input type="checkbox"/> 26D<br><input type="checkbox"/> 32<br><input type="checkbox"/> 32D | <input type="checkbox"/> D = HS | <input type="checkbox"/> 001 = MARKS | <input type="checkbox"/> A = 2101<br><input type="checkbox"/> B = 2102<br><input type="checkbox"/> D = 2104<br><input type="checkbox"/> E = 2105<br><input type="checkbox"/> F = 2106<br><br><b>KIK</b><br><input type="checkbox"/> A = Standard Tail<br><input type="checkbox"/> B = Classroom Tail<br><input type="checkbox"/> C = i-Que Electronic<br><br><b>IC CORE</b><br><input type="checkbox"/> A = 6 Pin IC<br><input type="checkbox"/> B = 7 Pin IC | <input type="checkbox"/> 0 = "0" Bitted<br><input type="checkbox"/> 1 = KD<br><input type="checkbox"/> 2 = KA<br><input type="checkbox"/> 3 = CMK<br><input type="checkbox"/> 4 = GMK<br><input type="checkbox"/> 5 = MK<br><input type="checkbox"/> 6 = GGМК | <input type="checkbox"/> U = UL 437<br><input type="checkbox"/> N = NON UL | <input type="checkbox"/> 0 = "0" Bitted<br><input type="checkbox"/> 1 = 1 Key<br><input type="checkbox"/> 2 = 2 Keys<br><input type="checkbox"/> 3 = 3 Keys<br><br>Up to 9, Then as separate line item |

| How To Order Example<br>for HI-SECURITY™ Keys |                   |                     |                            |                               |
|---|-------------------|---------------------|----------------------------|-------------------------------|
| <b>HS</b>                                     | <b>6</b>          | <b>D</b>            | <b>001</b>                 | <b>C</b>                      |
| 1.<br><i>Key Type</i>                         | 2.<br><i>Pins</i> | 3.<br><i>Keyway</i> | 4.<br><i>Security Code</i> | 5.<br><i>Special Key Type</i> |

| KEY TYPE  | PINS   | KEYWAY                          | SECURITY CODE                        | SPECIAL KEY TYPE                         |
|---|--|---------------------------------|--------------------------------------|--|
| <input type="checkbox"/> HS = HI-SECURITY™<br><input type="checkbox"/> RS = IC Core | <input type="checkbox"/> 5 Pin<br><input type="checkbox"/> 6 Pin<br><input type="checkbox"/> 7 Pin | <input type="checkbox"/> D = HS | <input type="checkbox"/> 001 = Marks | <input type="checkbox"/> C = Control Key |

HI-SECURITY™  
Cylinders









# HI-SECURITY™ CYLINDERS









## KEYS, CAMS & TAILPIECES

| KEYS  |                                     |                    |       |
|---|-------------------------------------|--------------------|-------|
|  | PART #                              | DESCRIPTION        | PRICE |
|   | HS5D001                             | 5 Pin Key Blank    | 8     |
|   | HS6D001                             | 6 Pin Key Blank    | 8     |
|   | RS6D001                             | 6 Pin IC Key Blank | 8     |
|   | RS7D001                             | 7 Pin IC Key Blank | 8     |
|   | <b>Schlage® IC CORE CONTROL KEY</b> |                    |       |
| HSR3184   | 6 or 7 Pin IC Key Blank             | 8                  |       |
| CUT KEYS  |                                     |                    |       |
| Conventional Cylinder   |                                     |                    | 11    |
| IC Core Cylinder  |                                     |                    | 11    |

| KEYING CHARGES |                              |       |
|----------------|------------------------------|-------|
| PART #         | DESCRIPTION                  | PRICE |
| KA, KD         | Keyed Alike, Keyed Different | NC    |
| MK             | Master Keyed                 | 20    |
| GMK            | Grand Master Keyed           | 20    |
| GGMK           | Great Grand Master Keyed     | 20    |
| CMK            | Construction Master Keyed    | 29    |
| VKC            | Visual Key Control           | 14    |

| MORTISE CYLINDER CAMS   |                |       |  |
|---|----------------|-------|--|
| PART #  | DESCRIPTION    | PRICE |  |
|  2101HS      | Straight Cam   | 5     |  |
|  2102HS     | Clover Cam     | 5     |  |
|  2104HS    | Adams Rite Cam | 5     |  |
|  2105HS    | J - Cam        | 5     |  |
|  2106HS    | G - Cam        | 5     |  |
|  2107-CLHS | Straight Cam   | 5     |  |

| Schlage® LARGE FORMAT IC CORE HOUSING CAMS   |                |       |  |
|--|----------------|-------|--|
| PART #   | DESCRIPTION    | PRICE |  |
|  2101 HSPM      | Straight Cam   | 5     |  |
|  2102 HSPM     | Clover Cam     | 5     |  |
|  2104 HSPM    | Adams Rite Cam | 5     |  |
|  2105 HSPM    | J - Cam        | 5     |  |
|  2106 HSPM    | G - Cam        | 5     |  |
|  2107-CL HSPM | Straight Cam   | 5     |  |

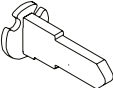
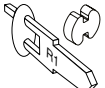
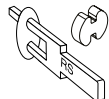
| CYLINDRICAL TAIL PIECES  |                                   |       |  |
|--|-----------------------------------|-------|--|
| PART #   | FUNCTIONS                         | PRICE |  |
|  F1903-C    | AB, DW, F                         | 7     |  |
|  F1903S-C   | S, DA, DB, DC, SB, T              | 7     |  |
| IC CORE TAILPIECES   |                                   |       |  |
|  HR1984-HS  | AB, B, DA (ext.), DW, F, FEU, FEL | 7     |  |
|  HR1984S-HS | S, DA (int.), DB, DC, SB, T       | 7     |  |

HI-SECURITY™  
Cylinders

# HI-SECURITY™ CYLINDERS



## PARTS LIST

| PARTS LIST     |   |       |             |
|----------------|---|-------|-------------|
| PART #         | DESCRIPTION                                   | PRICE | PACKED      |
| P2031          | Finger Pins #1 (Silver)                       | 25    | 25 per pack |
| P2032          | Finger Pins #2 (Copper)                       | 25    | 25 per pack |
| P2033          | Finger Pins #3 (Black)                        | 25    | 25 per pack |
| P2034          | Finger Pins #4 (Gold)                         | 25    | 25 per pack |
| 2035           | Sidebar - Schlage® IC                         | 25    | 25 per pack |
| 2036           | Sidebar - Combo, KIK, Mortise                 | 25    | 25 per pack |
| 2051           | Sidebar - Best® IC                            | 25    | 25 per pack |
| 2037           | Sidebar Springs                               | 25    | 50 per pack |
| 2044           | Mortise Cam Screws                            | 14    | 12 per pack |
| 2045           | IC Mortise Cam Screws - SCHLAGE® ONLY         | 14    | 12 per pack |
| 2038           | Hardened Steel Pins                           | 14    | 12 per pack |
| 2041           | Schlage® IC Cap Pin                           | 25    | 12 per pack |
| 2042           | Schlage® IC Cap Pin Spring                    | 25    | 12 per pack |
| 2046           | Schlage® IC Screw Cap                         | 25    | 6 per pack  |
| 2048           | KIK Screw Cap                                 | 25    | 6 per pack  |
| 2043           | Best® IC Clip                                 | 25    | 12 per pack |
| 2039           | Top Hex Screws (HI-SECURITY™ Mortise)         | 14    | 12 per pack |
| 2040           | Top Hex Screws (HI-SECURITY™ Best® IC)        | 14    | 12 per pack |
| 2047           | HI-SECURITY™ Registration Card                | 39    | 10 cards    |
| R2984          | 7 Pin IC Tailpiece (AB, DW, F)                | 5     | —           |
| R2984S         | 7 Pin IC Tailpiece (S, DA, DB, DC, SB, T, TS) | 5     | —           |
| R1981          | Spacer  | 5     | —           |
| K2030          | Parts Kit                                     | 277   | —           |
| 2049           | Plug Holder                                   | 39    | —           |
| BXXX-D133B1N1C | Cut Away Mortise Cylinder                     | 107   | —           |
| BXXX-D133B1N1P | Plastic Mortise Cylinder                      | 107   | —           |
| HSICT          | Shear Tool                                    | 221   | —           |
| HSC387         | HPC Card C387                                 | 49    | —           |

HI-SECURITY™  
Cylinders

# SERIES M9900 EXIT DEVICE

## RIM MOUNT



- EXTRUSION HEAVY GAGE 32D FINISH
- LIFETIME MECHANICAL WARRANTY
- PANIC PROTECTOR™ END CAP
- EASY INSTALLATION, ECONOMICAL



| MARKS #     | FUNCTION                   | PRICE |     |
|-------------|----------------------------|-------|-----|
|             |                            | 32D   | 10B |
| M9900       | Rim Panic                  | 419   | 488 |
| M9900F      | Fire Rated Rim Panic       | 473   | 542 |
| M9900 - 48  | Rim Panic - 48"            | 462   | 531 |
| M9900F - 48 | Fire Rated Rim Panic - 48" | 517   | 586 |

  

| OPTIONS   |                         |
|-----------|-------------------------|
| M9900     | 33" Length for 38" Door |
| M9900-48" | 42" Length for 48" Door |

| SPECIFICATIONS   |
|--|
| • <b>Doors:</b> 1 3/4" thick standard  |
| • <b>End Cover:</b> Stainless steel beveled "Panic Protector" design                             |
| • <b>Strike:</b> Roller strike   |
| • <b>Rail Assembly:</b> Heavy Gauge Stainless Steel  |
| • <b>Dead latch Bolt:</b> Stainless Steel 3/4" throw.  |
| • <b>Dead latch Bolt:</b> Stainless Steel 5/8".  |
| • <b>Dogging feature:</b> Allen Key (M9900)  |
| • <b>UL listed:</b> For "Panic Hardware" and Fire Rated Model 3 hour fire doors up to 38" x 86". |
| • <b>ANSI:</b> ANSI 156.3 (2001), requirements for Grade 1                                       |
| • <b>3 Hour Fire Rating</b>  |
| • <b>Finished:</b> Stainless steel satin finish  |

# SERIES M9900 VR EXIT DEVICE

## SURFACE VERTICAL ROD

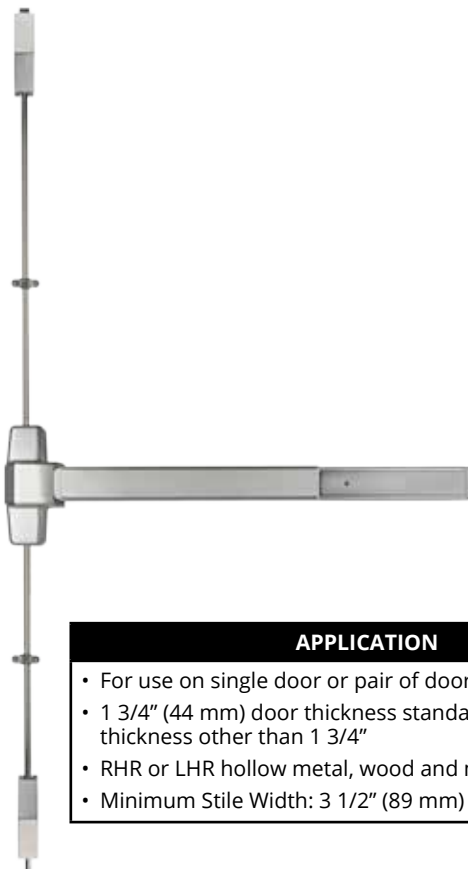







| APPLICATION   |
|---|
| • For use on single door or pair of doors                                     |
| • 1 3/4" (44 mm) door thickness standard. Specify thickness other than 1 3/4" |
| • RHR or LHR hollow metal, wood and mineral core doors                        |
| • Minimum Stile Width: 3 1/2" (89 mm)   |

| MARKS #        | FUNCTION                                | PRICE |     |
|----------------|---|-------|-----|
|                |   | 32B   | 10B |
| M9900 VR       | Rim Panic Vertical Rod                  | 557   | 620 |
| M9900F VR      | Fire Rated Rim Panic Vertical Rod       | 613   | 682 |
| M9900 - 48 VR  | Rim Panic Vertical Rod - 48"            | 584   | 653 |
| M9900F - 48 VR | Fire Rated Rim Panic Vertical Rod - 48" | 640   | 705 |

| SPECIFICATIONS   |
|--|
| • <b>Device Head Cover:</b> Zinc alloy or stainless steel  |
| • <b>Chassis:</b> Steel, plated  |
| • <b>Mechanism Housing:</b> Extruded aluminum  |
| • <b>Push Bar Base:</b> Extruded aluminum  |
| • <b>Touch Plate:</b> Stainless Steel  |
| • <b>End Cap:</b> Stainless Steel  |
| • <b>Top Latch:</b> Stainless Steel 37/64" (14.8mm)  |
| • <b>Top Strike:</b> Included  |
| • <b>Bottom Latch:</b> Stainless Steel 37/64" (14.8mm)   |
| • <b>Bottom Strike:</b> Included   |
| • <b>Latch Case Covers:</b> Steel, stainless steel or brass  |
| • <b>Vertical Rods:</b> Aluminum tube  |
| • <b>Hand:</b> Non-handed  |
| • <b>Mounting:</b> Machine screws standard. Sex bolts optional. Order "SNB" for wood or unreinforced metal doors |
| • <b>Dogging:</b> Allen-type key furnished   |
| • <b>Finish:</b> 32D   |
| • <b>Outside Trim:</b> Order separately  |
| • <b>Standard Height:</b> 7' doors   |
| • <b>UL listed:</b> ANSI/BHMA Grade 1 Panic Exit Hardware  |
| • <b>3-Hour Fire Rated</b>   |

Exit Devices

# SERIES M9900 EXTERIOR TRIM

|   |   |  |
|---|---|--|
| M411  | Lever/Rose  | Rim Panic Vandal Pull  |
|  | <br>M195F          | MVP/32D                               |
| MES600A   | Cylindrical Dogging Kit - 32D   | Rim Panic Vandal Pull w/ cylinder hole   |
|  | <br>M9901<br>M9902 | MVPCC/32D<br>(cylinder not included)  |

**ENTRY LEVER TRIM**





- Standard Marks "C" Keyway KNK cylinder for panic device.
- Cylinder locks or unlocks lever, rigid when locked; when unlocked retracts latch bolt.
- Marks 26D Finish / Standard 1-3/4" Door Thickness
- IC Prep Code G1, Less Cylinder G3

**ESCUTCHEON LEVER DESIGN**

- Thru bolt design
- Non Handed design. Easily field reversible.
- Marks 32D Finish / Standard 1-3/4" Door Thickness
- Standard Marks "C" Keyway 1-1/4 Mortise cylinder with special cam
- IC Prep Code G1
- Less Cylinder G3

| MARKS #   | DESCRIPTION                            | PRICE |     |
|-----------|--|-------|-----|
|           |  | 26D   | 10B |
| M411      | Finger Pill - no cylinder              | 22    | 25  |
| MESC600A  | Lever / Escutcheon Trim Entry          | 128   | 170 |
| MESC600F  | Lever / Escutcheon Trim Storeroom      | 128   | 170 |
| MESC600N  | Lever / Escutcheon Trim Passage        | 111   | 154 |
| MESC600DT | Lever / Escutcheon Trim Dummy Trim     | 111   | 154 |
| M9901     | 36 inch Panic Device Dogging Kit       | 72    | —   |
| M9902     | 48 inch Panic Device Dogging Kit       | 80    | —   |
| MVR8      | Vertical Rod 8 ft extension - Code 8   | 40    | —   |
| MVR10     | Vertical Rod 10 ft extension - Code 10 | 64    | —   |
| MVRB      | Vertical Rod - Bottom Rod              | 27    | —   |
| MVP/32D   | Rim Panic Vandal Pull                  | 191   | —   |
| MVPCC/32D | Rim Panic Vandal Pull w/ cylinder hole | 212   | —   |

## MORTISE CYLINDER CAMS

|       |  |                          |
|-------|--|--------------------------|
| M9907 |    | MESC600A                 |
| M9908 |    | MESC600F                 |
| M9909 |   | MESC600F IC CORE HOUSING |
| M9910 |  | MESC600A IC CORE HOUSING |

# SERIES M8800 EXIT DEVICE

THIN LINE TM RIM MOUNT

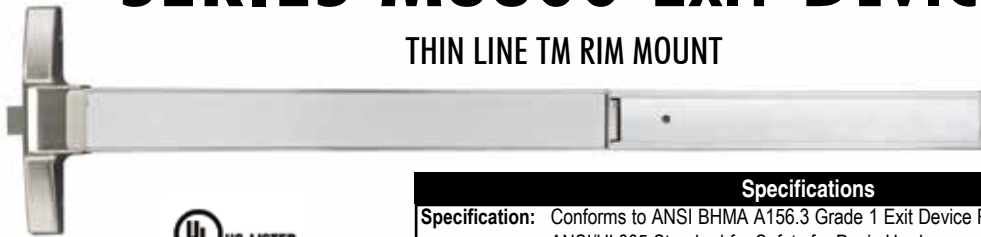

| MARKS #    | FUNCTION        | PRICE |
|------------|-----------------|-------|
|            |                 | 32D   |
| M8800      | Rim Panic       | 466   |
| M8800 - 48 | Rim Panic - 48" | 509   |

**Specifications**

**Specification:** Conforms to ANSI BHMA A156.3 Grade 1 Exit Device Requirement Standard  
ANSI/UL305 Standard for Safety for Panic Hardware  
2013 California Building Code Sec. 11B-309.4

**For Doors:** (Please specify when ordering non standard size doors)  
Thickness: Standard 1 3/4", may fit with door thickness up to 2"  
Width: Standard 36" or 48", may fit door width 30"-48"

**Mounting:** Furnished Standard with Wood and Machine Screws

**Head Cover:** Zinc Alloy

**Chassis:** Aluminum

**Rail Assembly:** Heavy Gauge extruded aluminum with stainless steel on top of touch bar

**End Cap:** Zinc Alloy

**Hand:** Non-handed

**Latch Bolt:** Stainless Steel, 3/4" (18mm) throw

**Strike:** Roller Strike (Stainless Steel)

**Dogging:** Allen Key (equipped on panic rate devices only)

**Finish:** 32D: Satin Stainless Steel Finish  
10B: Oil Rubbed Bronze Finish

**Dimension:** Touch bar height from finished floor: 41" (1041mm) from center of touch bar  
Touch Bar Projection: Neutral: 3 5/16" (84mm)  
Depressed: 2 19/32" (66mm)  
Head Cover: LxWxH: 206mm x 76mm x 71mm  
Device Length: 34 5/8" (88cm) for 36" door width  
46 5/8" (118.5 cm) for 48" door width

Exit Devices

# SERIES M195 EXIT DEVICE TRIM

## Specifications

**Levers:** Solid cast Zamac, with 1/2" return (except 395 & 495)  
**Roses:** Thru-bolted, 3-7/16" spring loaded Roses  
**Door Thickness:** 1-5/8" – 1-7/8"  
**Clutch:** Standard  
**Chassis:** Aluminum  
**Cylinder:** MARKS "C" keyway, 6 pin w/ 2 keys  
 IC Core model - Core not included  
*Lifetime Mechanical Warranty*

| MARKS #            | Trim      | 26D | 10B |
|--------------------|-----------|-----|-----|
| M195S/295/395/495  | MLHL650S  | 159 | 201 |
| M195F/295/395/495  | MLHL650F  | 159 | 201 |
| M195N/295/395/495  | MLHL650N  | 148 | 180 |
| M195DT/295/395/495 | MLHL650DT | 148 | 180 |

| OPTIONS                       | CODE | PRICE - 195 | 295 | 395 | 495 |
|-------------------------------|------|-------------|-----|-----|-----|
| Yale Conventional             | F7   | 23          | —   | —   | —   |
| Sargent conventional cylinder | F8   | 23          | 22  | —   | —   |
| Corbin conventional cylinder  | F9   | 23          | 22  | —   | —   |
| Corbin 6 pin IC core          | F12  | 34          | 32  | —   | —   |
| Corbin 7 pin IC core          | F13  | 34          | —   | —   | —   |
| Yale 6 pin IC core            | F14  | 23          | 22  | —   | —   |
| Yale 7 pin IC core            | F15  | 23          | —   | —   | —   |
| Schlage 6 pin IC core         | F19  | 23          | 22  | —   | —   |
| Sargent IC core               | F20  | 23          | 22  | —   | —   |
| Medeco IC core large format   | F21  | 23          | 22  | —   | —   |
| Less Cylinder                 | G3   | Deduct 15   | —   | —   | —   |

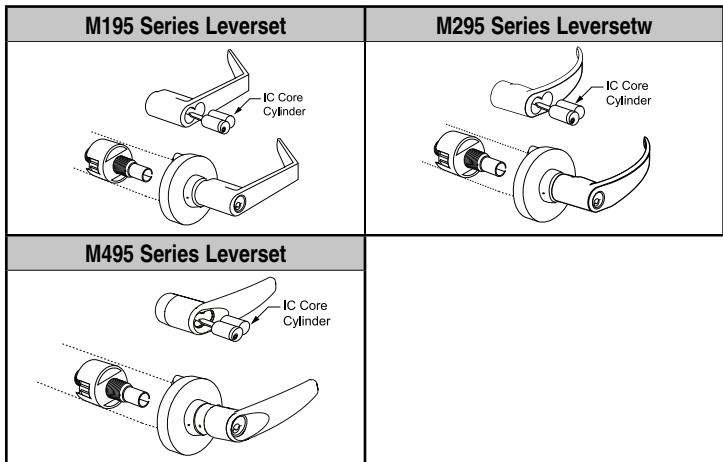

★ **Standard & HI-SECURITY™ IC Core Models:** Interchangeable Core models for 6 or 7 pin cores (not included). **Accepts:** Marks, Marks HI-SECURITY™, Medeco®, KeyMark™, Falcon, Schlage® small format & Best®. **IC Core Tailpieces ARE Included.**

# SERIES M9300 EXIT DEVICE

## MORTISE



| MARKS # | DESCRIPTION         | PRICE |
|---------|---------------------|-------|
| M9300   | Mortise Exit Device | 1224  |

## APPLICATION

- For use on single doors or active leaf of double doors
- 1-3/4" (44 mm) door thickness standard. Specify thickness other than 1-3/4".
- RHR or LHR hollow metal, wood and mineral core doors.

## MORTISE LOCK SPECIFICATIONS

**Lock Case:** Steel plated 6 1/16" x 3 15/16" x 29/32"  
 (154mm x 100mm x 23mm)  
**Anti-friction Latchbolt:** 3/4" (19mm) throw  
**Hand:** Reversible without removing the lock from the door  
**Auxiliary Deadlocking Bolt:** Non-handed, stainless steel  
**Faceplate:** Adjustable, 19/32" stainless steel or brass.  
**Strike:** ANSI 4 7/8"

## DEVICE SPECIFICATIONS

**Device Head Cover:** Zinc alloy or stainless steel  
**Chassis:** Steel, plated  
**Housing:** Extruded aluminum  
**Push Bar Base:** Extruded aluminum  
**Touch Plate:** Stainless steel  
**End Cap:** Zinc alloy  
**Hand:** Non-handed  
**Mounting:** Machine screws standard. Sex bolts optional. Order "SNB" for wood or nonreinforced metal doors  
**Dogging:** Allen-type key furnished  
**Finish:** 32D, Additional finishes consult factory  
**Outside Trims:** Order separately  
**UL Listed:** ANSI/BHMA Grade1 Panic Exit Hardware, 3-Hour Fire Exit Hardware.

# ELECTRIC LATCH RETRACTION

WITH SIMULTANEOUS DOGGING

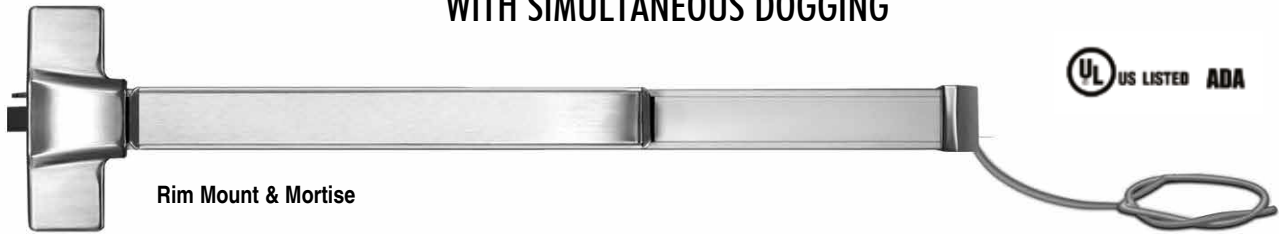

Rim Mount & Mortise

UL US LISTED ADA

| DEVICE SPECIFICATIONS       |  |
|-----------------------------|--|
| <b>ER</b>                   | Electric Latch Retraction with simultaneous dogging  |
| <b>For:</b>                 | M9900, M9300   |
| <b>Example:</b>             | M9900/32D-ER   |
| <b>Operation:</b>           | Momentary or maintained latch bolt and push pad retraction.<br>Automatic re-triggering of latch retraction |
| <b>Voltage:</b>             | 24VDC @ 450 mA activation, 180 mA continuous   |
| <b>602RF</b>                | 1 Amp power supply (1 EMC max)   |
| <b>632RF</b>                | 2 Amp power supply (2 EMC max)   |
| <b>EMC</b>                  | 2-station sequencer required for automatic doors only.   |
| <b>Monitoring Available</b> | Latch status and REX output available  |

| MARKS #           | DESCRIPTION                                  | PRICE |
|-------------------|--|-------|
| <b>HEAVY DUTY</b> |  |       |
| M9900ER           | Electric Latch Retraction                    | 776   |
| M9900ERP          | Electric Latch Retraction w 602 Power Supply | 1165  |
| M9300ER           | Electric Latch Retraction                    | 1892  |
| M9300ERP          | Electric Latch Retraction w 602 Power Supply | 2282  |

Exit Devices

# EXIT ALARM



Door sign included, Bar sign optional

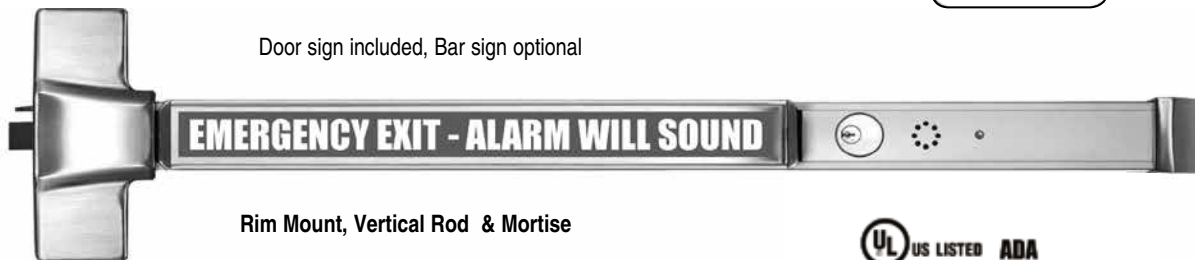

Rim Mount, Vertical Rod & Mortise

UL US LISTED ADA

| DEVICE SPECIFICATIONS |  |
|-----------------------|--|
| <b>EA</b>             | Exit Alarm, 9V battery powered   |
| <b>EB</b>             | Exit Alarm, 12-24V AC/DC input, 9V battery backup  |
| <b>For:</b>           | M9900, M9900VR   |
| <b>Example:</b>       | M9900/32D-EA   |
|                       | <ul style="list-style-type: none"> <li>100 dB alarm; visual and audible On/Off status:<br/>Armed - green LED blinks every 4 seconds,<br/>Alarm mode - red LED, Bypass - no LED</li> <li>Remote status output</li> <li>15 or 60 second arming delay</li> <li>2 modes: Continuous alarm with manual key reset; Automatic re-arm<br/>2 minutes after door closes with any manual key reset before 2 minutes.</li> </ul> |
| <b>Options:</b>       | <ul style="list-style-type: none"> <li>Push pad sign</li> <li>6, 10 &amp; 20 minutes alarm; 1 or 5 second re-arm delay</li> <li>Remote access control, arm, disarm inputs</li> <li>REX and latch status outputs</li> </ul>   |

| MARKS #           | DESCRIPTION                         | PRICE |
|-------------------|-------------------------------------|-------|
| <b>HEAVY DUTY</b> |                                     |       |
| M9900EA           | Exit Alarm 9VDC                     | 1029  |
| M9900EB           | Exit Alarm 9VDC w 12/24 AC/DC Input | 1074  |
| M9300EA           | Exit Alarm 9VDC                     | 1781  |
| M9300EB           | Exit Alarm 9VDC w 12/24 AC/DC Input | 1825  |

# ELECTRIC FRAME ACTUATOR

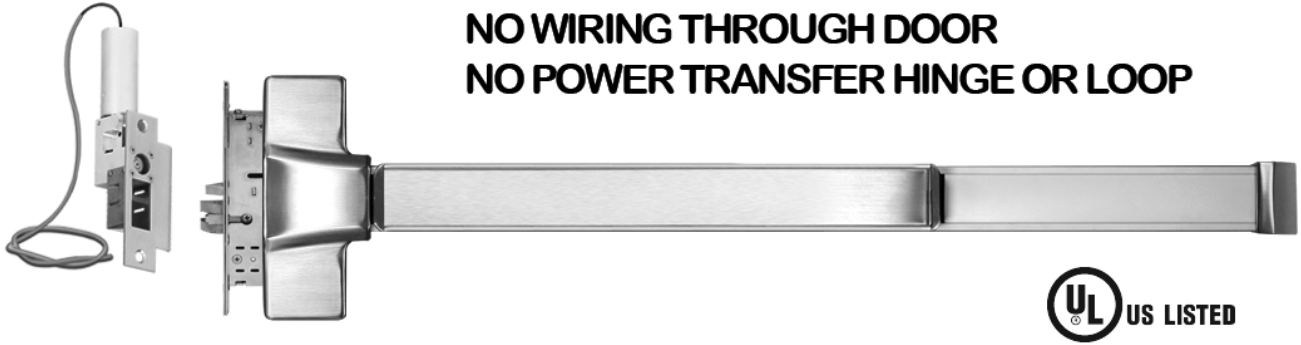

**NO WIRING THROUGH DOOR  
NO POWER TRANSFER HINGE OR LOOP**



| DEVICE SPECIFICATIONS   |
|---|
| <p><b>EFA Hitower Pro Frame Actuator Controlled Fire Exit Device</b><br/>Features include failsafe operation and unlocks by access control, power loss or signal from fire command center. Door stays latched even when unlocked. All wiring is maintained in the strike jamb. Complies with national building and fire codes</p> <p><b>Specify Handing and Voltage:</b> 24VDC, 24VAC, 115VAC<br/><b>Monitoring Available</b></p> |

| MARKS #           | DESCRIPTION                                    | PRICE       |
|-------------------|--|-------------|
| <b>HEAVY DUTY</b> |  |             |
| M9900EFA          | HiTower Pro Fram Actuator Controller Fire Exit | <b>1855</b> |

# ELECTRIC DOGGING



**Rim Mount, Vertical Rod & Mortise**



| DEVICE SPECIFICATIONS  |
|--|
| <p><b>DG Electric Dogging (failsecure) M9100, M9900, M9900VR, M9300</b><br/><b>Example: M9900/32D-DG</b><br/>When energized by optional built-in or remote switch manual, depressing the pushpad, causes the pushpad and latch to remain retracted (unlocked) providing push-pull door operation. When de-energized or signaled by a fire alarm, the pushpad and latch are released.</p> <p><b>Voltage:</b> 170/100 mA @ 12/24VDC<br/><b>Monitoring Available:</b> Latch status and REX output available</p> |

| MARKS #           | DESCRIPTION                                      | PRICE       |
|-------------------|--|-------------|
| <b>HEAVY DUTY</b> |  |             |
| M9900DG           | Electric Dogging, Fail Secure                    | <b>1033</b> |
| M9900DGP          | Electric Dogging, Fail Secure w 602 Power Supply | <b>1405</b> |
| M9300DG           | Electric Dogging, Fail Secure                    | <b>1749</b> |
| M9300DGP          | Electric Dogging, Fail Secure w 602 Power Supply | <b>2120</b> |

Exit Devices

# DELAYED EGRESS



Rim Mount, Vertical Rod & Mortise

| DEVICE SPECIFICATIONS        |  |
|------------------------------|--|
| <b>DE</b>                    | Wall mount delayed egress controller with keypad and electrified exit device, M9900, M9900VR   |
| <b>Example:</b>              | M9900F/32D-DE  |
| <b>DEK</b>                   | Keypad controller with redundant key switch capable of all keypad control features   |
| <b>602RF</b>                 | 1 Amp power supply   |
|                              | <ul style="list-style-type: none"> <li>User PIN codes may be assigned to 1, 2 or all control functions. Reset, sustained bypass and momentary bypass (RES)</li> <li>Audible alarm voice release time, warning or safety message</li> <li>Visual display countdown, locked/unlocked, egress executed</li> <li>15 or 30 second exit delay, 1 or 2 second nuisance delay 2 minutes</li> </ul> |
| <b>Monitoring Available:</b> | Latch status available   |

| MARKS #           | DESCRIPTION                                   | PRICE |
|-------------------|---|-------|
| <b>HEAVY DUTY</b> |   |       |
| M9900DE           | Delayed Egress                                | 1882  |
| M9900KDE          | Delayed Egress w Keyswitch                    | 1988  |
| M9900DEP          | Delayed Egress w 602 Power Supply             | 2253  |
| M9900KDEP         | Delayed Egress w Keyswitch W 602 Power Supply | 2359  |
| M9900VRDE         | Delayed Egress                                | 2014  |
| M9900VRKDE        | Delayed Egress w Keyswitch                    | 2120  |
| M9900VRDEP        | Delayed Egress w 602 Power Supply             | 2385  |
| M9900VRKDEP       | Delayed Egress w Keyswitch W 602 Power Supply | 2491  |

Exit Devices

# M9900 LITE



Adapter plate included

| MARKS #   | FUNCTION               | PRICE |
|-----------|------------------------|-------|
| M9900LITE | Rim Panic with IQ7LITE | 949   |

## IQ7LITE

### IQ7 LITE Rim Exit Device Interface Specifications

**Door Thickness:** 1-3/4" standard; For thicker doors, Consult factory

**Handing:** Non-handed

**Key Override:** 1-1/8" Mortise cylinder, 6 pin w/2 keys

**Clutch:** The "Clutch" for trouble free service

## M9900

- **Doors:** 1-3/4" thick standard.
- **End cover:** Flush mounted beveled "Panic Protector" design.
- **Strike:** Roller strike.
- **Rail Assembly:** Extruded Aluminum, 32D finish.
- **Dead latch Bolt:** Stainless Steel 3/4" throw.
- **Dead latch Bolt:** Stainless Steel 5/8".
- **Dogging feature:** Allen Key (M9900)
- **UL listed:** For "Panic Hardware" and Fire Rated Model 3 hour fire doors up to 38" x 86".
- **ANSI:** ANSI 156.3 (2001), requirements for Grade 1.
- **3 Hour Fire Rating**
- **Finish:** 32D



# POWER TRANSFER HINGE

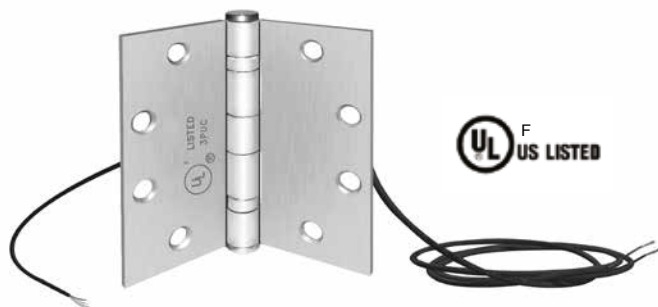

10B Listed for 3hr Fire Rated Door

| CODE   | DESCRIPTION                    | PRICE |
|--------|--------------------------------|-------|
| P1     | Power Transfer Hinge MPTH - 4  | 156   |
| P2     | Power Transfer hinge MPTH - 10 | 205   |
| PTH-4  | Four conductor hinge           | 160   |
| PTH-10 | Ten conductor hinge            | 205   |

## FEATURES

- UL10B Listed for 3 Hr Fire Doors. If the hinge you are presently using does not bear the F mark, it is not listed for use with fire doors.
- 500,000 cycles. 5 times UL test criteria
- Wire Replacement Warranty
- 5ft wire cable

## APPLICATION

Installed in the center hinge position of the door, PTH Power Transfer Hinges provide the concealed wires required between the door and the frame, for the purpose of powering and monitoring electric door hardware.

- Electric Lock Power and Control
- Door and Lock Status Signaling
- Request-to-Exit Signaling

**PTH-4** Four conductor hinge, 1 Amp @ 12/24V per pair, 4.5" x 4.5" five knuckle standard weight

**PTH-10** Ten conductor hinge, 1 Amp @ 12/24V per pair, 4.5" x 4.5" standard weight

Consult factory for 3 knuckle, or special size

## Finish

All base material steel  
Aluminum, Duranodic, US 3, 10B, 26D & 32D finishes

## Options

**DPS** Concealed Door Position Switch SPDT, 250mA @ 30VDC



# FIRE RATED CONCEALED MORTISE POWER TRANSFER

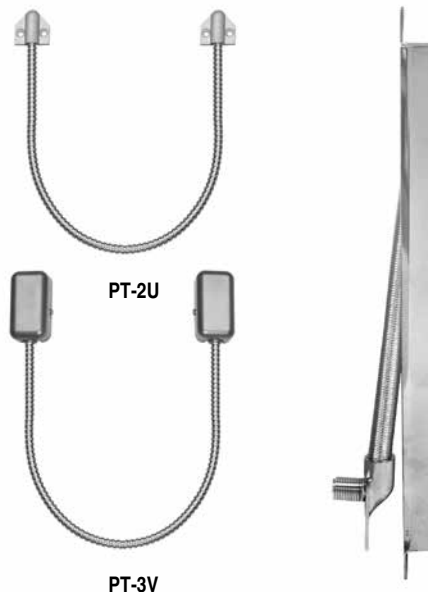

| CODE  | DESCRIPTION                             | PRICE |
|-------|---|-------|
| P3    | Power Transfer loop MPT-2U              | 19    |
| P4    | Power Transfer Loop MPT-3V              | 42    |
| PT-2U | Power Transfer Loop with end caps       | 25    |
| PT-3V | PTL w/ aluminum wire termination box    | 50    |
| PT-5  | Concealed Mortise Power Transfer Loop   | 65    |
| 602 C | Access Control Power Supply and Charger | 330   |

## FEATURES

### PT-5 Concealed Mortise Mount Power Transfer Loop

Frame mortised steel dust box with flexible steel loop and chrome finish. Recommended for use with hollow metal frames. UL Listed

**Dimensions:** 11.5"H x 1"W x 0.75"D (292 x 25.4 x 19mm)  
10B Listed For 3 Hrs Fire Rated Doors



## POWER TRANSFER LOOPS

18" (447mm) stainless steel armored flex conduit with small plastic end caps or termination box. Recommended for use with hollow metal and aluminum frames.

**PT-2U** With end caps

**PT-3V** With aluminum wire termination box

## 602 C POWER SUPPLY

Access Control Power Supply and Charger, Selectable 12/24VDC, 1 Amp, Emergency Release Input, Low Battery Disconnect, 12" x 12" x 4" Cabinet, UL, Class 2



**Options:** Key locked cover; 6 ft power cord; cover or interior mounted on-off switches; manual reset switches; 7 day, skip a day timer; Rechargeable batteries.

**Multiple fuse protected outputs:** Fuse modules provide protection for 4 or 8 individual circuits.

**Dual 12 and 24VDC output capability:** 12VDC voltage regulators enable dual 12 and 24VDC output capability for 12 and 24VDC components with one power supply.

**Relay and Timer Modules:** Relay and timer modules provide interface and control capability for single and multiple stations.

# TOUCHLESS EXIT SWITCH

## NO TOUCH WAVE-TO-EXIT SWITCH

For Sanitary Entry/Exit applications

DPDT Dry Contact Output • No Moving Parts • Bi-color Status Illumination



Red: Standby  
**474U**  
Price - 85



Green: Active  
**474DU**  
Price - 140

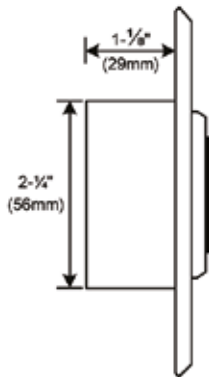

Side View

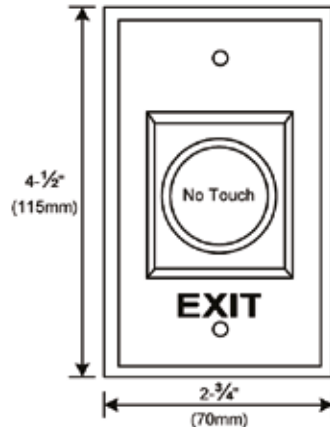

Front View

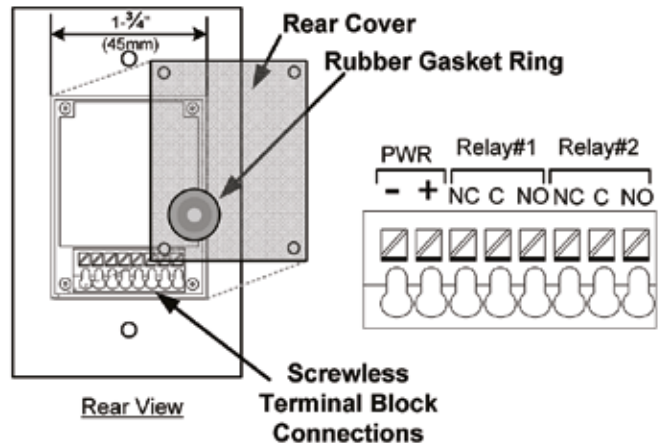

Rear View

Screwless Terminal Block Connections

### SPECIFICATIONS

**Input:** 25mA (standby); 55mA (Active) @ 12/24VDC

**Output:** 2-SPDT, 3 Amp Dry Contact

**Activation Time:**

1 second or as long as sensor is triggered

**LED Color:** Standby RED; Active Green

**Range:** 4" (10cm)

**Weight:** 3 oz. (85g)

**Dimensions:** 4.5" x 2.75" x 1.375"  
(115 x 70 x 35mm)

### FEATURES & APPLICATIONS

- Uses IR Sensor technology; device is active with the simple wave of a hand
- Designed to control electric locks/strikes, magnetic locks, or automatic door operators
- Ideal for use in sanitary applications such as cleanrooms, bathrooms, food processing, hospitals and labs.
- Sensing Range up to 4" (10cm)
- Mounted on a durable stainless steel plate
- Dual LED, illuminated sensor, Red/Green indicates Inactive/Active status
- Quick connect screwless terminal block for easy installation

# How To ORDER DOOR CLOSERS & PANIC DEVICES

| CODE  | OPTIONS  | PRICE |
|---|--|-------|
| P1  | Power Transfer Hinge MPTH - 4  | 158   |
| P2  | Power Transfer hinge MPTH - 10   | 205   |
| P3  | Power Transfer loop MPT-2U   | 19    |
| P4  | Power Transfer Loop MPT-3V   | 42    |
| P5  | Latch Status   | 84    |
| P6  | REX  | 84    |
| P7  | Push Pad Sign  |       |
| P8  | Keyswitch  | 84    |
| <b>POWER SUPPLY OPTIONS</b>                             |  |       |
|   | FB-4 Fused Terminal board 4 individually fused outputs   | 42    |
| P8  | ACM-1 Access Control Module. One SPST voltage output, One SPDT Status output eight triggered inputs (4N/C, 4N/O) led Status indicator  | 95    |
| .....   | EMC - Sequencer Module required for pair of doors and automatic doors 12/24 VDC for use with Marks M602RF and M632RF power supplies  | 158   |
| P10   | UR2-4 , Universal Controller for 2 doors. Field select TD, LR, TD/LR, mantrap A, B, C interlock. Two fused SPDT dry outputs, 5 Amp @ 30VD  | 231   |
| P11   | UR4-8 Universal Controller for 4 doors. Field select TD, LR, CR, TD/LR, mantrap A, B interlock. Four fused SPDT dry outputs, 5 Amp @ 30VDC. Four SPDT dry outputs, 1 Amp @ 30VDC. Two inputs per station, four auxiliary inputs. | 326   |
| P12   | PSM Power Supply Monitoring Module<br>For remote monitoring of power supply AC input, DC output and battery backup On/Off status. 2 SPDT Relay Outputs, 1 Amp @ 12/24VDC   | 231   |
| UR1-V1  | Universal Field Programmable Application Module  | 100   |
| 14-2  | 7 day programmable timer with memory battery back-up capability<br>Output: 1 SPDT, dry contact<br>Voltage: 16 Amps @ 30 VAC/DC<br>Specify 12V AC/DC or 24 AC/DC  | 268   |
| M620RF  | Power supply 12/24VDC 1 amp  | 368   |
| M632RF  | Power supply 12/24VDC 2 amp  | 473   |
| MRB12V4   | 12V/5Ah Battery. Specify in pairs for 24V  | 42    |
| MRB12V7   | 12V/8Ah Battery Specify 2 for 24V  | 63    |
| <b>HEAVY DUTY SERIES ECLECTIC POWER TRANSFER DEVICE</b> |  |       |
| PTM-2AL   | Two (2) 18 Ga. Conductor 5 Amp @ 12/24V AC/DC Aluminum Powder coated   | 376   |
| PTM-10AI  | Ten (10) 24GA wires 1 Amp @ 12/24V AC/DC Aluminum Powder coated  | 376   |
| <b>TRIMS</b>  |  |       |
|   | Electric Trim for M9900 Features, Fail secure, Field Reversible to failsafe, Audible tone, 4Ft cable and connectors 600/300 Ma @ 12/24VDC  |       |
| ####  | American Lever   | 709   |
| #####   | Crescent Lever   | 709   |
| <b>Options for Trim</b>                                 |  |       |
|   | Tri Clor LED   | 84    |
| <b>SWITCHES</b>   |  |       |
| M474U   | Sanitary, No Touch wave to exit switch. IR sensor 4" read range Red, Green LED status, output DPDT 3 Amp dry contact input 25mA (stand by) 55mA (active) @ 12 VD, face plate 20ga Stainless steel                                | 79    |
| M422U   | Momentary SPDT PUSH TO EXIT  | 74    |
| M422AU  | Momentary SPDT 2" Button - Blue illuminated lens only  | 74    |
| M423U   | Integrated electronic timer, adj. 1-60 sec 12/24VDC, 2A DPST Contact PUSH TO EXIT  | 130   |
| M423AU  | Integrated 1-60 sec Timer 12/24VDC, 2A DPST Contact 2" Button - Blue illuminated lens only Symbol  | 130   |
| M424U   | Momentary DPDT PUSH TO EXIT  | 110   |
| M425U   | AA (On/Off) DPDT NONE  | 110   |
| MD-31D-W  | PASSIVE INFRARED EGRESS CONTROL, Motion detector with time delay, white  | 247   |
| MD-31D-B  | PASSIVE INFRARED EGRESS CONTROL, Motion detector with time delay, black  | 247   |

# ARCHITECH™ SERIES NETWORK LOCKS

Ideal access control solution; elegantly blending advanced wireless access control convenience within any decor, in attractive, infinitely customizable designer locking form, in choice of trims and finishes.



| Features  |
|---|
| <ul style="list-style-type: none"> <li>• 5000 Users, 500 Scheduled Events &amp; 40,000 Event Audit Trail</li> <li>• Surface-Mount or Mortised - in Electronics and Battery Pack</li> <li>• Lock available in Mortise and Cylindrical versions</li> <li>• Real Time Clock - Uses 4 AA Batteries – 3 to 4 year battery life</li> <li>• Operated via access card, fob, key fob etc</li> <li>• DL-Windows Software for programming</li> <li>• USB Radio Key Programming Method or Via Network Gateways</li> <li>• Manual Card Enrollment Option for Quick Installation</li> <li>• Wireless programming range: up to 20 ft. from lock</li> </ul> |
| Specifications  |
| <ul style="list-style-type: none"> <li>• ANSI / BHMA Grade 1 Certified, UL Listed 3 Hours</li> <li>• Includes standard lever rose hardware design</li> <li>• Compatible with all 300+ optional architectural trim / lever or knob designs</li> <li>• Stainless steel latch, 2-3/4" backset</li> <li>• Auto-Reverse lock body tested to 6 million cycles</li> <li>• Lock Body - Self cleaning long life motor</li> <li>• Door closure monitor / electronic deadbolt monitor</li> <li>• Key override standard or high-Security</li> <li>• Optional integrated door position indicator switch</li> </ul>                                       |

| PRODUCT            | PRICE       |
|--------------------|-------------|
| <b>Cylindrical</b> |             |
| N90S2195F26D       | <b>933</b>  |
| N90S1195F26D       | <b>933</b>  |
| <b>Mortise</b>     |             |
| N95S2RX92FD26D     | <b>1166</b> |
| N95S1RW86FD26D     | <b>1166</b> |

## Mounted Samples

| PRODUCT            | PRICE                  |
|--------------------|------------------------|
| <b>Cylindrical</b> |                        |
| N90S1295SK26D      | <b>consult factory</b> |
| S90S1195SK26D      | <b>consult factory</b> |
| N90S1195SK26D      | <b>consult factory</b> |
| <b>Mortise</b>     |                        |
| N95S1RW86SK26D     | <b>consult factory</b> |

## ArchiTech™ Series Network Locks Parts and Accessories

| PRODUCT    | DESCRIPTION  | PRICE       |
|------------|--|-------------|
| AL-IME     | Ethernet connected gateway w/AC adapter to plug into standard wall outlet                  | <b>541</b>  |
| AL-IM80211 | Wi-Fi gateway to connect to 802.11 network w/AC adapter to plug into standard wall outlet. | <b>753</b>  |
| AL-IMEPOEP | Power Over Ethernet, plus hardwire gateway interface capability. No AC Power required.     | <b>647</b>  |
| AL-IME-USB | USB Gateway  | <b>318</b>  |
| AL-NSM     | Network Signal Meter   | <b>314</b>  |
| ALHID1326  | Proximity Access Cards 100 Per Box   | <b>535</b>  |
| ALHID1336  | Proximity, Magnetic Stripe and Photo ID cards 100 per box                                  | <b>1092</b> |
| ALHID1386  | Proximity and Photo ID Card 100 per box  | <b>983</b>  |
| ALHID1391  | MicroProx Tag 10 per box   | <b>87</b>   |
| ALHID1346  | Proximity keyfob 10 per box  | <b>125</b>  |

ArchiTech Series Network Locks

# ARCHITECH™ SERIES NETWORK LOCKS

Standard Model Ordering. Infinite Custom Models available. Call Factory For Ordering Assistance.

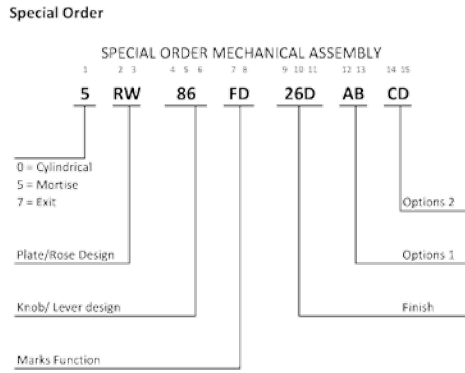
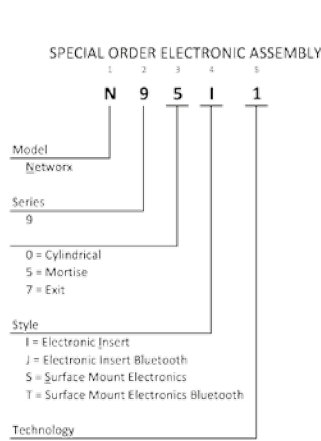

- 1 = Prox Oval
- 2 = Prox Square
- 3 = Mag Stripe Oval
- 4 = Mag Stripe Square
- 5 = Keypad Oval
- 6 = Keypad Square
- 7 = Keypad Prox Oval
- 8 = Keypad Prox Square
- 9 = Keypad Mag Stripe Oval
- 0 = Keypad Mag Stripe Square
- A = Smart Oval (iClass® Technology)
- B = Smart Square (iClass® Technology)
- C = Concealed Prox

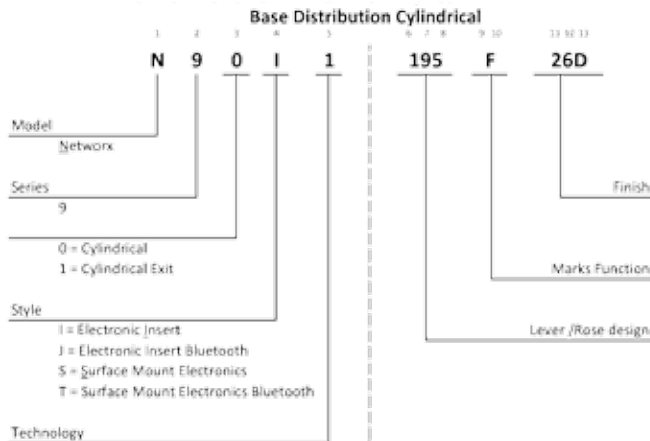
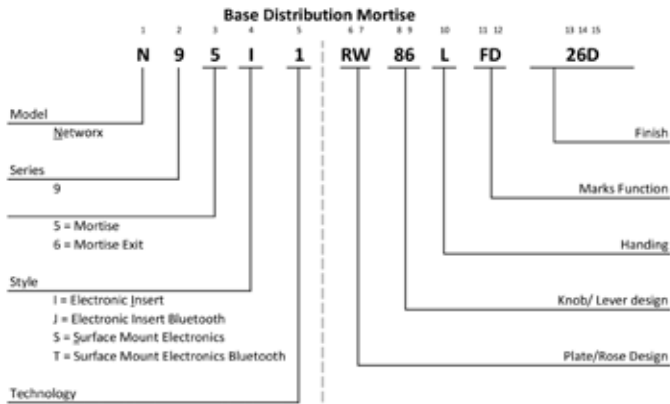

ArchTech Series Network Locks







**MARKS USA**

AMITYVILLE, N.Y. 11701

[www.marksusa.com](http://www.marksusa.com)

DISTRIBUTED BY:

631-225-5400 • 800-645-9445 • FAX 631-225-6136