

A: GENERAL INFORMATION

| | |
|--------------------------|------|
| Terms and Conditions | A:1 |
| General Information | A:3 |
| Weights and Measurements | A:12 |
| Order Forms | A:15 |

B: NEW PRODUCTS

| | |
|--|-----|
| Microban | B:1 |
| Halo Touch | B:2 |
| HomeConnect 620 Keypad Connected Smart Lock | B:4 |
| Prague | B:6 |
| Singapore | B:8 |

C: KWIKSET SIGNATURE SERIES

| | |
|----------------|------|
| Handlesets | C:3 |
| Levers | C:9 |
| Knobs | C:12 |
| Deadbolts | C:14 |
| Specifications | C:15 |

D: KWIKSET

| | |
|----------------|-----|
| Handlesets | D:2 |
| Levers | D:4 |
| Knobs | D:5 |
| Deadbolts | D:6 |
| Combo Packs | D:6 |
| Specifications | D:7 |

E: ELECTRONIC LOCKS

| | |
|----------------|-----|
| Halo | E:2 |
| Smartcode | E:4 |
| Home Connect | E:6 |
| Specifications | E:8 |

F: LIGHT COMMERCIAL

| | |
|---|-----|
| Multi-Family, Light Commercial & Key Control | F:1 |
| Specifications | F:4 |

G: ACCESSORIES

| | |
|-------------------|-----|
| Pocket Door Locks | G:1 |
| SmartKey Padlocks | G:1 |
| Trim | G:1 |

H: SERVICE PARTS

| | |
|---------------|------|
| Keys | H:1 |
| Pin & Tumbler | H:2 |
| SmartKey | H:6 |
| Smartkey SC1 | H:7 |
| Key Control | H:8 |
| Latches | H:9 |
| Strikes | H:12 |
| Screw Packs | H:15 |
| Miscellaneous | H:19 |
| Electronics | H:21 |

TERMS AND CONDITIONS OF SALE

Standard terms are 2% prompt payment discount for payment within 25 days from date of invoice; net 30 days from the date of invoice. Kwikset® reserves the right to charge and recover on invoices which are not paid within the above terms, a service charge of 1-1/2% a month for each month or fraction thereof during which the invoice remains unpaid, said service charge, however, not to exceed the highest applicable legal rate of interest. All orders, whether solicited or written by our sales representatives or forwarded by our customers are deemed to be mere offers to purchase in accordance with these Terms and Conditions of Sale until actually accepted by us at our home office in Lake Forest, CA. We reserve the right to refuse any order as well as the right to sell or not sell to any firm at our sole discretion. The acceptance of an order is expressly made conditional upon your assent to these Terms and Conditions of Sale. We object to the inclusion of any different or additional terms or conditions, even if the same are included in your order, a contract of sale will result upon the Terms and Conditions of Sale stated herein only. Prices reflected in this book apply to Wholesale customers only.

All sales are final.

PRICES

Pricing based on full-case quantities only; orders for less than full case will be automatically adjusted up to the next full-case quantity. All prices are subject to change without notice and are not guaranteed. All taxes, duties or other charges are the responsibility of the customer.

CLAIMS

Price claims must be submitted in writing to Kwikset, 19701 Da Vinci, Lake Forest, CA 92610 within 30 days from the date of invoice.

CHANGES OR CANCELLATIONS

Beyond 5 working days of our acknowledgement date no changes can be made. Additions to an order will be handled as a separate order and must meet applicable minimum order requirements. Order cancellation on regular stock items only, or any portion thereof is allowed only upon prior written consent from Kwikset, and the payment of cancellation charges deemed appropriate.

MINIMUM CHARGE

No order will be invoiced for less than \$100.00 net plus shipping charges except for lock accessory parts.

MINIMUM ANNUAL SALES VOLUME

The company reserves the right to discontinue direct sales to any customer who does not meet the minimum annual sales volume requirement. The current annual requirement is \$50,000.00. Your annual purchases are determined by accepted, non-cancelled, and shipped orders received during each calendar year. Kwikset reserves the right to change any or all minimum annual sales volume requirements at any time. Any customer who does not meet the annual sales volume requirements may continue to purchase Kwikset products through a Kwikset distributor.

RETURNS

Defective merchandise returned to our factories requires prior written authorization from a Kwikset Sales Rep or the Sales Office. A factory return authorization must accompany the returned shipment. The return authorization must include an itemized listing of the merchandise and an explanation stating the reason for return.

There will be a 20% product restocking fee on all returned merchandise.

FREIGHT

All goods are invoiced FOB to our factory. Upon delivery of shipments to the carrier, title to, and the risk of loss or damage in transit for such shipments, passes to our customer. Kwikset's standard policy is to pay freight charges on all orders over \$1,000.00 net invoice value to a single destination in the continental U.S., by carrier and route of our choice. Shipments less than these quantities will not be shipped on a prepaid basis. If higher freight charges are incurred from customers specifying a carrier or route of their choice the additional cost will be added to that customer's invoice.

DELIVERY CONDITIONS

Shipping schedules are our best estimates, and cannot be guaranteed. Kwikset is not responsible for any direct or consequential loss or damage resulting from an inability or delay in meeting shipping schedules.

KWIKSET LIMITED WARRANTIES

Kwikset products are backed by one of the most comprehensive warranty programs available. You can feel confident that with the purchase of Kwikset you have selected the best quality product, backed by the best customer service available.

MECHANICAL LIMITED WARRANTY

Except as otherwise provided below, Spectrum Brands, Inc., for its Kwikset® brand products ("Kwikset"), warrants to the original residential purchaser (the "Purchaser") that each Kwikset product (the "Product(s)" or "Kwikset Product(s)") will be free from mechanical defects under normal use from the date of purchase for as long as said Purchaser occupies the residential premises upon which the Product was originally installed ("Warranty Period"). This Mechanical Limited Warranty applies only to Products that were purchased from Kwikset or a Kwikset authorized seller, unless otherwise prohibited by law. Kwikset Products are legitimately sold only by authorized sellers who are required to follow Kwikset's policies, procedures, and quality control standards. Kwikset reserves the right to reject warranty claims from purchasers for Products purchased from unauthorized sellers, including unauthorized Internet sites.

FINISH LIMITED WARRANTY

The finish on Kwikset Products is protected by a durable topcoat designed to maintain the beauty and quality of the Kwikset Product. Kwikset warrants to the Purchaser that the finish of the Product shall be free of defects in material and workmanship from tarnishing, flaking, and discoloring from the date of purchase for as long as said Purchaser occupies the residential premises upon which the Product was originally installed ("Warranty Period"). This Finish Limited Warranty applies only to Products that were purchased from Kwikset or a Kwikset authorized seller, unless otherwise prohibited by law. Kwikset Products are legitimately sold only by authorized sellers who are required to follow Kwikset's policies, procedures, and quality control standards. Kwikset reserves the right to reject warranty claims from purchasers for Products purchased from unauthorized sellers, including unauthorized Internet sites.

ELECTRONIC LIMITED WARRANTY

Kwikset warrants to the Purchaser that Kwikset Products will be free from electronic defects under normal use for one (1) year from the date of purchase, as long as said Purchaser occupies the residential premises upon which the Product was originally installed ("Warranty Period"). This Electronic Limited Warranty applies only to Products that were purchased from Kwikset or a Kwikset authorized seller, unless otherwise prohibited by law. Kwikset Products are legitimately sold only by authorized sellers who are required to follow Kwikset's policies, procedures, and quality control standards. Kwikset reserves the right to reject warranty claims from purchasers for Products purchased from unauthorized sellers, including unauthorized Internet sites.

EXCLUSIONS FROM WARRANTY

1. Any Kwikset Product produced prior to January 1, 2006.¹
2. Any Kwikset Product which has been damaged as a result of installation contrary to any of Kwikset's written installation instructions is not covered by these warranties.
3. Any Kwikset Product which has been modified by any non-Kwikset component is not covered by these warranties.
4. Any Kwikset Product having a defect caused by neglect, misuse, abuse or unreasonable or extraordinary use or maintenance, including use in a commercial application, is not covered by these warranties.
5. Any Kwikset Product having a defect due to use of paints, solvents, or other chemicals is not covered by these warranties.
6. Any Kwikset Product that is used in combination with knobs, levers, or trim of other than those manufactured by Kwikset and designated for use with the applicable locks or latches is not covered by these warranties.
7. Any Kwikset Product that was purchased from an unauthorized seller is not covered by these warranties.

These warranties are not transferable. Therefore, no transferee is covered by these warranties.

¹ Kwikset Products produced prior to January 1, 2006, may be eligible for warranty in accordance with the terms and conditions of the applicable warranty program.

WARRANTY CLAIMS

If you wish to make a warranty claim based upon a Product defect, please call us at 1-800-327-LOCK (5625) or contact us at kwikset.com/support.

Please note that you will be required to provide a description of any claimed defect(s) and a dated receipt or other proof of purchase from Kwikset or the Kwikset authorized seller, to verify warranty eligibility.

Certain claimed defect(s) covered by these warranties may be resolved by Kwikset providing you with troubleshooting steps.

Other claimed defect(s) covered by these warranties may require Product replacement. Products may not be returned to Kwikset without prior authorization from Kwikset. If authorized by Kwikset, you will need to mail your Product to:

Spectrum Brands, Inc.

ATTN: Kwikset Consumer Services

19701 Da Vinci

Lake Forest, CA 92610

A prepaid shipping label will be provided to you.

REMEDIES

For certain claimed defect(s) covered by these warranties, as determined by Kwikset, Kwikset will provide you with troubleshooting steps.

For other claimed defect(s) covered by these warranties, as determined by Kwikset, Kwikset will replace the defective Product or part.

If a Kwikset Product, which is the same as the Kwikset Product or any part covered by these warranties, has been discontinued at the time of replacement or if Kwikset determines, in its sole discretion, that such replacement is inappropriate, Kwikset reserves the right to substitute an alternative product. Kwikset also reserves the right to accept or reject an alternative product proposed as a replacement, when the value is higher than that of the Product originally purchased by the Purchaser. Except as expressly provided in these warranties to the contrary, KWIKSET SHALL NOT BE OBLIGATED OR LIABLE FOR LABOR OR OTHER COSTS RELATED TO INSTALLATION, REPAIR OR REPLACEMENT OF A KWIKSET PRODUCT, OR FOR LOSS OF, OR DAMAGE TO ANY MATERIAL WHICH IS NOT SOLD BY KWIKSET.

PATENT INDEMNITY

We agree to defend any suit or proceeding brought against our customer so far as based on claim that our products, or any part thereof, made solely to our specifications and furnished to our customer constitute an infringement of any U.S. patent, if notified promptly in writing and given authority, information and assistance at our expense for the defense of same, and we shall pay all damages and costs awarded therein against our customer. In case our products, or any part thereof, is in such suit held to constitute infringement and their use is enjoined, we will, at our expense and discretion, either procure for our customer the right to continue using the products or replace same with non-infringing products, or modify them so they become non-infringing, or remove such products and refund the purchase price (less depreciation, prorated from the purchase date). The foregoing states our entire liability for patent infringement by our products or any part thereof.

INTELLECTUAL PROPERTY

No person or entity may sell, distribute, advertise, market or promote Kwikset branded products distributed by Kwikset Corporation ("Kwikset"), Spectrum Brands Hardware Home Improvement Division, without prior authorization from Kwikset. Customers of Kwikset who are authorized to sell Kwikset branded products are referred to herein as "Customers."

The Kwikset brand and all Kwikset trademarks, trade names, product depictions, colors, graphics or logos, whether or not registered or otherwise protected (the "Marks"), remain the sole and exclusive property of Kwikset and nothing arising out of the relationship between Kwikset and any Customer conveys to Customer any ownership rights in the Marks. Customer may use the Marks and then only in the sale or promotion of authentic Kwikset products in compliance with the terms of this policy. The Marks must be used exactly in the form provided and in conformity with all Kwikset trademark usage policies or guidelines, including, but not limited to, those relating to shape, color match and imprint quality. Any proposed deviation must be approved in writing by Kwikset prior to use. The Marks may not be used in or as part

of any Customer domain name on the Internet. Prior to any use of the Marks on goods or services, Customer must submit samples for Kwikset's approval.

Additionally, no Customer may use product depictions, graphics, logos or text relating to Kwikset products that have not been provided by Kwikset in connection with the advertising, promotion or sale of Kwikset products without Kwikset's prior review and written approval of each such use. The Marks may not be used in or as part of any reseller or other third party (i) domain name or VRL on the Internet, (ii) trademark or service mark, or (iii) company or trade name. Any action on the part of a Customer that violates the terms of this policy or otherwise impairs the value of or goodwill associated with the Marks or is otherwise not in conformity with Kwikset's standards may result in the suspension or termination of the Customer's authorization or any other remedy permitted by law.

Kwikset grants to each of its Customers limited, non-transferable, non-sublicenseable licenses of the patents relating to the Kwikset products that the Customer is authorized to sell and of the copyrights in any packaging or other written materials included therewith or related thereto. Said patent and copyright licenses are solely to sell such Kwikset products covered by such patents and to which such copyrights relate only to end-users and other Customers in compliance with the terms of this document. The sale of such patented Kwikset products and the sale or use of such copyrighted materials by a Customer that violate the terms of this document exceed the scope of the licenses herein granted to the Customer and may constitute patent and/or copyright infringement.

STANDARDS

Kwikset meets or exceeds the testing requirements specified for each product grade or rating.

- American National Standards Institute (ANSI)
- Builders Hardware Manufacturers Association (BHMA)
- Underwriters Laboratories, Inc. (UL)
- Americans with Disabilities Act (ADA)

MISCELLANEOUS

Substitution of non-Kwikset components/parts, and any alteration or modification of factory parts, and other lock manufacturer's parts may result in door hardware which does not function properly or will fail and will void all warranties. Orders not specified with keying requirements will be shipped Keyed Differently (KD). Orders with keying requirements of K10 or more must have a "Letter of Release" on file with Kwikset stating that Kwikset Corporation will not be held liable for cost and expense arising from any loss or damage to property utilizing Kwikset products where 10 or more locks have been keyed alike. Contact your Sales Office account representative for a copy of the release form. Kwikset reserves the right to revise or modify products, product information, or pricing without notice. Product specifications and pricing reflect available information at the time of printing. Kwikset is not responsible for typographic or printing errors.

LIMITATION OF LIABILITIES

THERE ARE NO WARRANTIES WHICH EXTEND BEYOND THOSE STATED HEREIN. ANY IMPLIED WARRANTIES THAT MAY BE APPLICABLE TO PRODUCTS, INCLUDING IMPLIED WARRANTIES OF MERCHANTABILITY OR FITNESS FOR A PARTICULAR PURPOSE, ARE LIMITED IN DURATION TO THE DURATION OF THIS WARRANTY. SOME STATES DO NOT ALLOW LIMITATIONS ON HOW LONG AN IMPLIED WARRANTY LASTS, SO THE ABOVE LIMITATION MAY NOT APPLY TO YOU. UNDER NO CIRCUMSTANCES SHALL KWIKSET BE LIABLE FOR ANY SPECIAL, INCIDENTAL, OR CONSEQUENTIAL DAMAGES BASED UPON BREACH OF THIS LIMITED WARRANTY, BREACH OF CONTRACT, OR STRICT LIABILITY. SOME STATES DO NOT ALLOW THE EXCLUSION OR LIMITATION OF INCIDENTAL OR CONSEQUENTIAL DAMAGES, SO THE ABOVE LIMITATION OR EXCLUSION MAY NOT APPLY TO YOU. THIS WARRANTY GIVES YOU SPECIFIC LEGAL RIGHTS, AND YOU MAY ALSO HAVE OTHER RIGHTS WHICH VARY FROM STATE TO STATE.

Effective Date: [July 6th 2020]

ORDER CODE BREAKOUT

| | |
|------------------|------------------------------|
| Quantity | Specifies Quantity |
| Function & Style | Specifies Model and Function |
| Rose Design | Specifies Designer Rose |
| Handing | Handing Right or Left |
| Finish | Exterior/Interior |
| Keying | Special Keying |
| Code | Keying Code |
| Latch | Specifies Latch |
| Strike | Indicates Strike |
| Key Alike Qty | Keyed Alike |

Example: "I would like to order 12 SmartKey Commonwealth levers, satin nickel finish, round corner latch & strike, 3 keyed alike" Written as:
12-740CHL 15 SMT RCAL RCS K3.

NOTE: All handlesets ordered LIP only.

UNDERWRITERS LABORATORIES LISTED LOCKSETS



To meet Underwriters Laboratories' fire rating requirements UL listed locksets, UL listed latches, and UL listed strikes must be used together.

AMERICAN WITH DISABILITIES ACT (ADA)



Products displaying this symbol comply with the Americans with Disabilities Act of 1990.

HOW TO ORDER 20MIN UL LOCKS

FD = 20 minute UL designation

Example: "I would like to order 12 passage Tustin levers with round corner latch and strike with 20 minute UL in Satin Nickel"
12-720TNL 15 RCALFD RCS.

NOTE: The latch configuration is not available with FD. There is a \$2.50 list price upcharge for 20 minute UL.

KEYING

| Code | Option |
|--------|--------------------------------------|
| KD | Keyed Differently |
| K2, K3 | Keyed Alike (2 Locksets, 3 Locksets) |
| MK | Master Keyed |
| PK | Builder (Protecto) Keyed |
| GMK | Grand Master Keyed |
| PMK | Builder (Protecto) Master Keyed |
| MAIS | Maison Keying |
| SEQ | Sequential Construction Keying |
| KBOX | Keys in One Box |
| SMT | SmartKey Security |

NOTE: Speciality Keying list prices can be found on page H:2

BACKSET

Backset is the distance from center edge of door to center of the 2-1/8" (54mm) diameter hole, 2-3/8" or 2-3/4" in most cases.

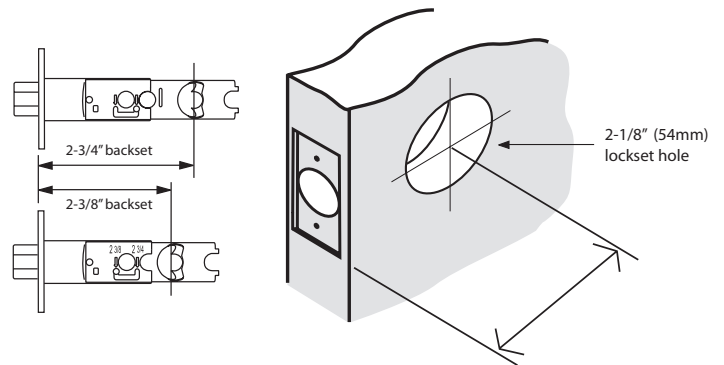

| Model | Function |
|-------------------------------------|--|
| 154/200/407/420/720/721/725 | Passage/Hall/Closet |
| 155/300/408/430/730/733/735 | Privacy/Bed/Bath |
| 334/335 | Round Pocket Door Lock |
| 400/401/438/740/741/756 | Entry |
| 156/405/406/409/413 | Lever Keyed Entry |
| 450/462/412/439/755/781 | Storeroom/Vestibule |
| 157/488/788 | Half Dummy Trim, Surface Mounted |
| 502/505/506/507/508 | Interconnect |
| 553/687/800/818 | Single Cylinder Handleset |
| 689/801 | Double Cylinder Handleset |
| 699/802/819 | Dummy Handleset |
| 898/814 | Handle Only |
| 899/815 | Handle and Lever Only |
| 598 | Single Cylinder Gatelatch |
| 599 | Double Cylinder Gatelatch |
| 604/605/606 | Interior Pack for Kwikset Handlesets |
| 158/258/660/780/782/980/982/816/817 | Single Cylinder Deadbolts |
| 159/665/784/785/984/985 | Double Cylinder Deadbolts |
| 905 | Keyless Touchpad Deadbolt |
| 912/916/954/888 | Home Connect Deadbolt and Lever |
| 907/909/913/915/919/917/955 | Electronic Single Cylinder Deadbolt and Lever |
| 942 | Bluetooth Enabled Deadbolt |
| 938/939 | WiFi Enabled Deadbolt |
| 953 | Keyless Touchscreen Deadbolt |
| 966/967/968/971/973/974/976/977 | Interior Pack for Kwikset Signature Series Handleset |
| 978/979 | Interior Pack for Montara Handleset |

HANDING

To determine the handing of a door face the OUTSIDE of the door. If the hinge is on the left side of the door, the door is left handed (LH). If the hinge is on the right side of the door, the door is right handed (RH).

NOTE: Handing required for dummy levers and interior packs with levers when lever design is not symmetric.

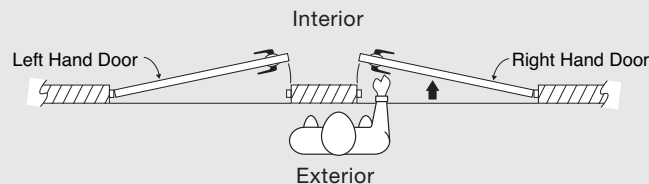



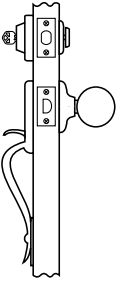
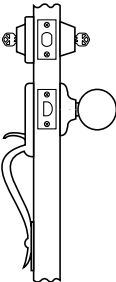
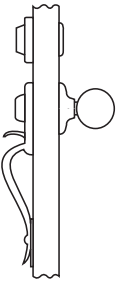
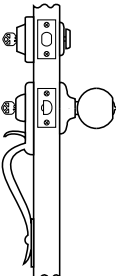

| Finish | Description | ANSI/BHMA | Latch | Description |
|--------|-------------------------|-----------|----------|---|
| 3 | Polished Brass | 605 | WFL | Wide Face Latch 2-1/4" x 1-1/8" |
| L03 | Lifetime Polished Brass | 605E | RCAL | Round Corner Adjustable Latch |
| 5 | Antique Brass | 609 | 6AL | 6-Way Adjustable Latch. All Parts Loose |
| 11P | Venetian Bronze | --- | SCAL | Square Corner Adjustable Latch |
| 15 | Satin Nickel | 619 | RFAL | Round Face Adjustable Latch |
| 15A | Antique Nickel | 620 | RCAL FD* | Round Corner Adjustable 20 Minute UL |
| 26 | Polished Chrome | 625 | SCAL FD* | Square Corner Adjustable 20 Minute UL |
| 26D | Satin Chrome | 626 | RFAL FD* | Round Adjustable 20 Minute UL |
| 514 | Matte Black | --- | | |

*NOTE: List charge for 20 minute UL is \$2.50

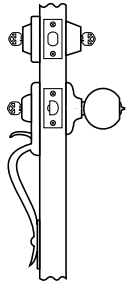
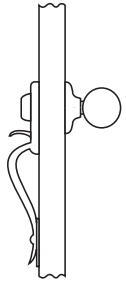
**KWIKSET SIGNATURE
SERIES w/ BHMA**

| HANDLESETS | Function Name | Description | KWIKSET w/ BHMA | SERIES w/ BHMA |
|---|--|---|-----------------|-----------------|
|  | <p>Handleset with Single Cylinder Deadbolt</p> | <p>Latch bolt operated by thumb piece outside and grip inside. Deadbolt operated by key outside and thumb turn inside.</p> | <p>687</p> | <p>800, 818</p> |
|  | <p>Handleset with Double Cylinder Deadbolt</p> | <p>Latch bolt operated by thumb piece outside and grip inside. Deadbolt operated by key both sides.</p> | <p>689</p> | <p>801</p> |
|  | <p>Dummy Handleset with Dummy Deadbolt</p> | <p>Handle and grip act as a pull only. For inactive leaf of double doors. No operation.</p> | <p>699</p> | <p>802, 819</p> |
|  | <p>Two Point Locking Handleset with Single Cylinder Deadbolt</p> | <p>Latch bolt operated by thumb piece outside and grip inside, except when both are locked by key outside or turn button inside. Deadbolt operated by key outside or thumb turn inside.</p> | <p>N/A</p> | <p>553 F94</p> |

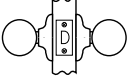
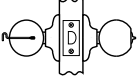
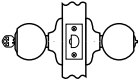
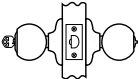
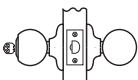
| HANDLESETS | Function Name | Description | KWIKSET w/ BHMA | KWIKSET SIGNATURE SERIES w/ BHMA |
|--|---|--|-----------------|----------------------------------|
|  | Two Point Locking Handleset with Double Cylinder Deadbolt | Latch bolt operated by thumb piece outside and grip inside, except when both are locked by key outside or turn button inside. Deadbolt operated by key both sides. | N/A | 554 |
|  | Handleset with Knob or Lever | Latch bolt operated by thumb piece outside and grip inside. | 898 | 815 |
|  | Handleset Only | Latch bolt operated by thumb piece outside | 899 | 814 |

| KNOBS | Function Name | Description | KWIKSET SIGNATURE | |
|--|----------------------------------|--|-------------------|----------------|
| | | | KWIKSET w/ BHMA | SERIES w/ BHMA |
|  | Passage/Hall/Closet | Both knobs always free. | 200 F75 | 720/725UL F75 |
|  | Privacy/Bed/Bath | Both knobs locked or unlocked by turn button inside. Outside knob unlocked by emergency key. | 300 F76 | 730/735UL F76 |
|  | Entry | Both knobs locked or unlocked by key outside or turn button inside. | 400 F82 | 740/745UL F82 |
|  | Entry, Free Interior | Outside locked or unlocked by key outside or turn button inside. Inside always free. | 401 F81 | 741/746UL F81 |
|  | Storeroom/Vestibule | Outside unlocked only while key is turned. Inside always free. | 450 F86 | 750/755UL F86 |
|  | Half Dummy Trim, Surface Mounted | For doors where only a pull is required. No operation. | 488 | 788 |



NOTE: BHMA code in italics. Optional UL 1/3 hour rating for all functions.

| LEVERS | Function Name | Description | KWIKSET w/ BHMA | KWIKSET SIGNATURE SERIES w/ BHMA |
|--------|----------------------------------|--|-----------------------|----------------------------------|
| | Passage/Hall/Closet | Both levers always free. | 200/407/420UL F75 | 154/720/725/725UL F75 |
| | Privacy/Bed/Bath | Both levers locked or unlocked by turn button inside. Outside lever unlocked by emergency key. | 300/408UL/430UL F76 | 155/730/735UL F76 |
| | Keyed Entry Lever | Both levers locked or unlocked by key outside or turn or push button inside. | 401/405/406UL F82 | 156/740/745/756UL F82 |
| | Entry, Free Interior | Outside locked or unlocked by key outside or turn button inside. Inside always free. | 401/406/413UL F81 | 741/746UL |
| | Storeroom/Vestibule | Outside unlocked only while key is turned. Inside always free. | 439/450/462/412UL F86 | 750/755UL/781 F86 |
| | Half Dummy Trim, Surface Mounted | For doors where only a pull is required. No operation. | 488 | 788/157 |

NOTE: BHMA code in italics. Optional UL 1/3 hour rating for all functions.

| DEADBOLTS | Function Name | Description | KWIKSET w/ BHMA | KWIKSET SIGNATURE SERIES w/ BHMA |
|-----------|-----------------|--|-----------------|--|
| | Single Cylinder | Deadbolt operated by key outside and thumb turn inside. | 660 E0153 | 980/982UL E0151 780/782UL/909 E0152 816/817UL E0152 158/258/913/997 E0142 |
| | Double Cylinder | Deadbolt operated by key both sides. | 665/E0143 | 985/984UL E0141 785/784UL E0142 996 159 E0152 |
| | Thumb Turn Only | Deadbolt operated by thumb turn one side. No trim on exterior. | 663 E0193 | N/A |

**KWIKSET SIGNATURE
SERIES w/ BHMA**

| DEADBOLTS | Function Name | Description | KWIKSET w/ BHMA | KWIKSET SIGNATURE SERIES w/ BHMA |
|---|---------------------------|---|------------------|----------------------------------|
| | Conversion Kit | Converts 663 to 667 when door is bored through. | 664 | N/A |
|  | Thumb Turn x Plate | Deadbolt operated by thumb turn on interior. Blank plate on exterior. | 667/677UL E01113 | N/A |
|  | Single Cylinder Gatelatch | Deadbolt operated by key outside and thumb turn inside. | N/A | 598 |
|  | Double Cylinder Gatelatch | Deadbolt operated by key both sides. | N/A | 599 |

**ELECTRONIC
DEADBOLTS**

**KWIKSET SIGNATURE
SERIES w/ BHMA**

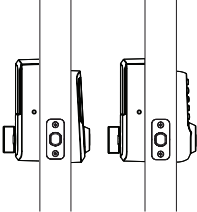
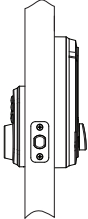
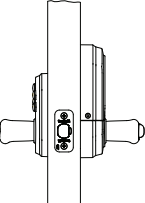
| ELECTRONIC DEADBOLTS | Function Name | Description | KWIKSET w/ BHMA | KWIKSET SIGNATURE SERIES w/ BHMA |
|---|---------------------|--|-----------------|----------------------------------|
|  | Halo™ | Deadbolt operated by key outside, electronic keypad or WiFi enabled device. | N/A | 938/939 E0152 |
|  | Aura™ | Deadbolt operated by key outside, electronic keypad or bluetooth enabled device. | N/A | 942 E0152 |
| | SmartCode™ Deadbolt | Deadbolt operated by key outside or electronic keypad and thumb turn inside. | N/A | 909/913/915/919 E0152 |
|  | SmartCode™ Lever | Keyed lever operated by key outside or electronic keypad and thumb turn inside. | N/A | 917/955 |

NOTE: BHMA code in italics

ROUND POCKET

DOOR LOCK

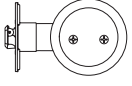
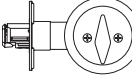
| | Function Name | Description | KWIKSET w/ BHMA | KWIKSET SIGNATURE SERIES w/ BHMA |
|---|---------------|--|-----------------|----------------------------------|
|  | Passage | Pocket door lock always free. | 334 | N/A |
|  | Privacy | Pocket door lock operated by thumb turn. | 335 | N/A |



LIGHT COMMERCIAL

LEVER

| | Function Name | Description | | LIGHT COMMERCIAL w/ BHMA |
|---|----------------------------------|--|---------------------------|--------------------------|
|  | Passage/Hall/Closet | Both levers always free. | 407/720/721/725UL | F75 |
|  | Privacy/Bed/Bath | Both levers locked or unlocked by ADA turn button inside. Outside lever unlocked by emergency key. | 408/730/733/735UL | F76 |
|  | Entry | Both levers locked or unlocked by key outside or ADA turn button inside. | 409/410/438/740/745UL/756 | F82 |
|  | Entry, Free Interior | Outside locked or unlocked by key outside or turn button inside. Inside always free. | 401/406/413/741/746UL | F81 |
|  | Storeroom/Vestibule | Outside unlocked only while key is turned. Inside always free. | 412/439/750/755UL/781 | F86 |
|  | Half Dummy Trim, Surface Mounted | For doors where only a pull is required. No operation. | 788 | |

NOTE: BHMA code in italics

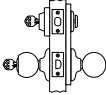
METAL

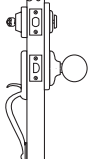
| INTERCONNECT | Function Name | Description | METAL INTERCONNECT Model w/BHMA |
|---|------------------------|--|--|
|  | Deadlock Latch | Operated by grip either side except when locked by key outside and thumb turn inside. Deadbolt operated by key outside and thumb turn inside. Inside grip simultaneously retracts dead latch and deadbolt latch. | 505/506UL F97 |
|  | Plain Latch | Operated by grip either side. Deadbolt operated by key outside and thumb turn inside. Inside grip simultaneously retracts plain latch and deadbolt latch. | 508/507UL F96 |
|  | Interior Assembly Only | Grip inside simultaneously retracts plain latch and deadbolt latch when matched with handleset on outside. | 502 |

NOTE: BHMA code in italics

| BOX PACK | Unit | | | | | Master Case | | | |
|------------------------------------|----------|--------------|-------------|--------------|---------------|-------------|--------------|-------------|--------------|
| | Quantity | Length (in.) | Width (in.) | Height (in.) | Weight (lbs.) | Quantity | Length (in.) | Width (in.) | Height (in.) |
| Kwikset Signature Series | | | | | | | | | |
| Deadbolts | | | | | | | | | |
| 780 Single Cylinder | 1 | 4.6730 | 3.9230 | 3.0720 | 2.2500 | 12 | 12.8750 | 12.5000 | 5.3125 |
| 785 Double Cylinder | 1 | 4.6730 | 3.9230 | 3.0720 | 2.7500 | 12 | 12.8750 | 12.5000 | 5.3125 |
| 816 Key Control | 1 | 4.6730 | 3.9230 | 3.0720 | 2.2500 | 12 | 12.8750 | 12.5000 | 5.3125 |
| 816 SQT Key Control Deadbolt | 1 | 4.92 | 4.13 | 3.15 | 2.02 | 12 | 12.99 | 13.19 | 5.51 |
| 980 Single Cylinder | 1 | 4.6730 | 3.9230 | 3.0720 | 2.2500 | 12 | 12.8750 | 12.5000 | 5.3125 |
| 985 Double Cylinder | 1 | 4.6730 | 3.9230 | 3.0720 | 2.7500 | 12 | 12.8750 | 12.5000 | 5.3125 |
| 158 Single Cylinder | 1 | 4.6730 | 3.9230 | 3.0720 | 2.2500 | 12 | 12.8750 | 12.5000 | 5.3125 |
| 159 Single Cylinder | 1 | 4.6730 | 3.9230 | 3.0720 | 2.7500 | 12 | 12.8750 | 12.5000 | 5.3125 |
| 258 Single Cylinder | 1 | 4.81 | 4.06 | 3.13 | 1.76 | 12 | 13.37 | 12.9 | 6.21 |
| Electronic Deadbolts/Levers | | | | | | | | | |
| 905 Powerbolt | 1 | 8 | 3.75 | 3.5 | 2 | 2 | 8.5 | 7.5 | 4.25 |
| 907 Powerbolt | 1 | 5.51 | 3.54 | 9.29 | 2.93 | 2 | 5.75 | 7.87 | 10.16 |
| 909 SmartCode | 1 | 5.5 | 3.5 | 10 | 2.88 | 2 | 7.6 | 6 | 10.5 |
| 912 SmartCode Lever | 1 | 3.5 | 6 | 10 | 61 | 2 | 7 | 12.5 | 10.4 |
| 913 SmartCode | 1 | 5.5 | 3.5 | 10 | 2.88 | 2 | 7.6 | 6 | 10.5 |
| 915/916/919/938/939/942 SmartCode | 1 | 3.5 | 5.38 | 9.88 | 3.14 | 2 | 10.50 | 7.75 | 5.94 |
| 916 / 954 | 1 | 9.75 | 4.0 | 4.28 | 3.12 | 1 | 10.25 | 4.63 | 4.44 |
| 916 / 954 | 1 | 5.32 | 5.79 | 8.86 | 4.40 | 2 | 11.42 | 6.69 | 10.24 |
| Handlesets | | | | | | | | | |
| 553 Single Cylinder | 1 | 15.9380 | 7.1250 | 4.0000 | 6.2500 | 4 | 16.4380 | 15.9380 | 7.8125 |
| 554 Double Cylinder | 1 | 15.9380 | 7.1250 | 4.0000 | 6.7500 | 4 | 16.4380 | 15.9380 | 7.8125 |
| 800 AUH Austin | 1 | 15.9380 | 7.1250 | 4.0000 | 7.0000 | 4 | 16.4380 | 15.9380 | 7.8125 |
| 801 AUH Austin | 1 | 15.9380 | 7.1250 | 4.0000 | 7.5000 | 4 | 16.4380 | 15.9380 | 7.8125 |
| 802 AUH Austin | 1 | 15.9380 | 7.1250 | 4.0000 | 6.5000 | 4 | 16.4380 | 15.9380 | 7.8125 |
| 800ADH Ashfield, 800AVH Avalon | 1 | 15.9380 | 7.1250 | 4.0000 | 7.0000 | 4 | 16.4380 | 15.9380 | 7.8125 |
| 801ADH Ashfield, 801AVH Avalon | 1 | 15.9380 | 7.1250 | 4.0000 | 7.5000 | 4 | 16.4380 | 15.9380 | 7.8125 |
| 802ADH Ashfield, 802AVH Avalon | 1 | 15.9380 | 7.1250 | 4.0000 | 6.5000 | 4 | 16.4380 | 15.9380 | 7.8125 |
| 800AN Arlington | 1 | 15.9380 | 7.1250 | 4.0000 | 7.0000 | 4 | 16.4380 | 15.9380 | 7.8125 |
| 801AN Arlington | 1 | 15.9380 | 7.1250 | 4.0000 | 7.5000 | 4 | 16.4380 | 15.9380 | 7.8125 |
| 802AN Arlington | 1 | 15.9380 | 7.1250 | 4.0000 | 6.5000 | 4 | 16.4380 | 15.9380 | 7.8125 |
| 800AT Amherst | 1 | 19.9380 | 7.6250 | 4.0000 | 8.9000 | 4 | 20.5000 | 16.0000 | 8.3875 |
| 801AT Amherst | 1 | 19.9380 | 7.6250 | 4.0000 | 9.9000 | 4 | 20.5000 | 16.0000 | 8.3875 |
| 802AT Amherst | 1 | 19.9380 | 7.6250 | 4.0000 | 6.9000 | 4 | 20.5000 | 16.0000 | 8.3875 |
| 800CE Chelsea | 1 | 15.9380 | 7.1250 | 4.0000 | 6.0000 | 4 | 16.4380 | 15.9380 | 16.6255 |
| 801CE Chelsea | 1 | 15.9380 | 7.1250 | 4.0000 | 6.5000 | 4 | 16.4380 | 15.9380 | 16.6255 |
| 802CE Chelsea | 1 | 15.9380 | 7.1250 | 4.0000 | 5.5000 | 4 | 16.4380 | 15.9380 | 16.6255 |
| 800HE Hawthorne | 1 | 15.9380 | 7.1250 | 4.0000 | 7.0000 | 4 | 16.4380 | 15.9380 | 7.8125 |
| 801HE Hawthorne | 1 | 15.9380 | 7.1250 | 4.0000 | 8.0000 | 4 | 16.4380 | 15.9380 | 7.8125 |
| 802HE Hawthorne | 1 | 15.9380 | 7.1250 | 4.0000 | 5.0000 | 4 | 16.4380 | 15.9380 | 7.8125 |
| 800SE Shelburne | 1 | 15.9380 | 7.1250 | 4.0000 | 7.9000 | 4 | 16.4380 | 15.9380 | 7.8125 |
| 801SE Shelburne | 1 | 15.9380 | 7.1250 | 4.0000 | 8.9000 | 4 | 16.4380 | 15.9380 | 7.8125 |
| 802SE Shelburne | 1 | 15.9380 | 7.1250 | 4.0000 | 5.9000 | 4 | 16.4380 | 15.9380 | 7.8125 |
| 800 Tavaris | 1 | 15.9380 | 7.1250 | 4.0000 | 8.0000 | 4 | 16.4380 | 16.6200 | 8.3800 |
| 801 Tavaris | 1 | 15.9380 | 7.1250 | 4.0000 | 8.2500 | 4 | 16.4380 | 16.6200 | 8.3800 |
| 802 Tavaris | 1 | 15.9380 | 7.1250 | 4.0000 | 8.0000 | 4 | 16.4380 | 16.6200 | 8.3800 |
| 966 Single Cylinder | 1 | 2.7 | 3.7 | 4.30 | 2.25 | 12 | 15.20 | 12.5 | 7 |
| 967 Double Cylinder | 1 | 2.7 | 3.7 | 4.30 | 2.25 | 12 | 15.20 | 12.5 | 7 |
| 968 Dummy | 1 | 2.7 | 3.7 | 4.30 | 2.25 | 12 | 15.20 | 12.5 | 7 |
| 978 Single Cylinder | 1 | 2.7 | 3.7 | 4.30 | 2.25 | 12 | 15.20 | 12.5 | 7 |
| 979 Double Cylinder | 1 | 2.7 | 3.7 | 4.30 | 2.25 | 12 | 15.20 | 12.5 | 7 |

| BOX PACK | Unit | | | | | Master Case | | | |
|---|----------|--------------|-------------|--------------|---------------|-------------|--------------|-------------|--------------|
| | Quantity | Length (in.) | Width (in.) | Height (in.) | Weight (lbs.) | Quantity | Length (in.) | Width (in.) | Height (in.) |
| Kwikset Signature Series Continued | | | | | | | | | |
| Knobs | | | | | | | | | |
| 720 Passage | 1 | 8.1730 | 3.9230 | 2.7840 | 2.0000 | 12/30 | 12.3750 | 11.5000 | 8.8125 |
| 730 Privacy | 1 | 8.1730 | 3.9230 | 2.7840 | 2.0000 | 12/30 | 12.3750 | 11.5000 | 8.8125 |
| 740 Entry | 1 | 8.1730 | 3.9230 | 2.7840 | 2.3300 | 12/30 | 12.3750 | 11.5000 | 8.8125 |
| 788 Dummy | 1 | 3.2360 | 2.7980 | 3.0100 | 0.3500 | 20 | 14.8750 | 12.5000 | 3.9375 |
| Levers | | | | | | | | | |
| 154/720 Passage | 1 | 7.8750 | 6.1250 | 3.1875 | 2.4200 | 12/20 | 19.7500 | 12.8750 | 8.5625 |
| 155/730 Privacy | 1 | 7.8750 | 6.1250 | 3.1875 | 2.4200 | 12/20 | 19.7500 | 12.8750 | 8.5625 |
| 156/740 Entry | 1 | 7.8750 | 6.1250 | 3.1875 | 2.4200 | 12/20 | 19.7500 | 12.8750 | 8.5625 |
| 157/788 Dummy | 1 | 5.8610 | 3.1100 | 2.8220 | 0.4500 | 20 | 15.8750 | 12.1250 | 6.6245 |
| 720 LL, TNL | 1 | 6.625 | 5.75 | 3.0 | 1.65 | 20 | 24 | 15.50 | 6.70 |
| 730 LL, TNL | 1 | 6.625 | 5.75 | 3.0 | 1.70 | 20 | 24 | 15.50 | 6.85 |
| 740 LL, TNL | 1 | 6.625 | 5.75 | 3.0 | 2.05 | 20 | 24 | 15.50 | 8.30 |
| 788 LL, TNL | 1 | 5.861 | 3.11 | 2.822 | 0.450 | 20 | 15.875 | 12.125 | 6.6245 |

| Kwikset | | | | | | | | | |
|---|---|---------|--------|--------|--------|----|---------|---------|---------|
| Combo Packs | | | | | | | | | |
| 690T Tylo Knob and Single Cylinder Deadbolt | 1 | 11.3090 | 3.4230 | 2.7840 | 2.8000 | 6 | 8.7500 | 7.3120 | 11.9375 |
| Deadbolts | | | | | | | | | |
| 598 Single Cylinder Gate Latch | 1 | 4.6730 | 3.9230 | 3.0720 | 2.2500 | 12 | 12.8750 | 12.5000 | 5.3125 |
| 599 Double Cylinder Gate Latch | 1 | 4.6730 | 3.9230 | 3.0720 | 2.2500 | 12 | 12.8750 | 12.5000 | 5.3125 |
| 660 Single Cylinder | 1 | 3.9480 | 3.4230 | 2.5720 | 0.5000 | 12 | 11.1250 | 11.0000 | 4.5625 |
| 665 Double Cylinder | 1 | 3.9480 | 3.4230 | 2.5720 | 0.9000 | 12 | 11.1250 | 11.0000 | 4.5625 |
| 663 One-Sided | 1 | 3.9480 | 3.4230 | 2.5720 | 0.5500 | 12 | 11.1250 | 11.0000 | 4.5625 |
| 667 One-Sided | 1 | 3.9480 | 3.4230 | 2.5720 | 0.9000 | 12 | 11.1250 | 11.0000 | 4.5625 |
| 664 Retrofit Kit | 1 | 3.9480 | 3.4230 | 2.5720 | 0.9000 | 12 | 11.1250 | 11.0000 | 4.5625 |
| 677 One-Sided | 1 | 3.9480 | 3.4230 | 2.5720 | 0.2500 | 12 | 11.1250 | 11.0000 | 4.5625 |
| Handlesets | | | | | | | | | |
| 604 Single Cylinder | 1 | 5.8000 | 3.9000 | 3.7000 | 2.25 | 12 | 15.20 | 12.5 | 7 |
| 605 Double Cylinder | 1 | 5.8000 | 3.9000 | 3.7000 | 2.25 | 12 | 15.20 | 12.5 | 7 |
| 606 Dummy | 1 | 5.8000 | 3.9000 | 3.7000 | 2.25 | 12 | 15.20 | 12.5 | 7 |
| 687 LIP | 1 | 15.9380 | 7.1250 | 4.0000 | 3.6000 | 6 | 15.0000 | 12.1250 | 16.6255 |
| 689 LIP | 1 | 15.9380 | 7.1250 | 4.0000 | 4.0000 | 6 | 15.0000 | 12.1250 | 16.6255 |
| 699 LIP | 1 | 15.9380 | 7.1250 | 4.0000 | 3.6000 | 6 | 15.0000 | 12.1250 | 16.6255 |
| Knobs | | | | | | | | | |
| 200 Polo | 1 | 8.1730 | 3.2980 | 2.7840 | 1.3000 | 30 | 17.1250 | 17.0000 | 8.8125 |
| 300 Polo | 1 | 8.1730 | 3.2980 | 2.7840 | 1.3000 | 30 | 17.1250 | 17.0000 | 8.8125 |
| 400 Polo | 1 | 8.1730 | 3.2980 | 2.7840 | 1.3000 | 30 | 17.1250 | 17.0000 | 8.8125 |
| 200 Tylo/Cove | 1 | 7.3610 | 3.2980 | 2.7840 | 1.1500 | 30 | 17.1250 | 17.0000 | 8.1870 |
| 300 Tylo/Cove | 1 | 7.3610 | 3.2980 | 2.7840 | 1.1500 | 30 | 17.1250 | 17.0000 | 8.1870 |
| 400 Tylo/Cove | 1 | 7.3610 | 3.2980 | 2.7840 | 1.1500 | 30 | 17.1250 | 17.0000 | 8.1870 |
| 488 Dummy | 1 | 3.2360 | 2.7980 | 3.0100 | 0.3500 | 20 | 14.8750 | 12.5000 | 3.9375 |
| Lever | | | | | | | | | |
| 200 Passage | 1 | 6.7980 | 5.7660 | 2.9720 | 1.3500 | 20 | 23.6250 | 15.3750 | 7.4995 |
| 300 Privacy | 1 | 6.7980 | 5.7660 | 2.9720 | 1.3500 | 20 | 23.6250 | 15.3750 | 7.4995 |
| 405 Keyed Lever | 1 | 6.7980 | 5.7660 | 2.9720 | 1.5800 | 20 | 23.6250 | 15.3750 | 7.4995 |
| 488 Dummy | 1 | 5.8610 | 3.1100 | 2.8220 | 0.4500 | 20 | 15.8750 | 12.1250 | 6.6245 |

| Miscellaneous | | | | | | | | | |
|-----------------------------|---|--------|--------|--------|-----|----|---------|---------|--------|
| Pocket Door Hardware | | | | | | | | | |
| 334 Passage | 1 | 4.3750 | 3.0000 | 2.0000 | .65 | 12 | 12.5000 | 14.3750 | 2.2500 |
| 335 Privacy | 1 | 4.3750 | 3.0000 | 2.0000 | .8 | 12 | 12.5000 | 14.3750 | 2.2500 |

| BOX PACK | Unit | | | | | Master Case | | | |
|--|----------|--------------|-------------|--------------|---------------|-------------|--------------|-------------|--------------|
| | Quantity | Length (in.) | Width (in.) | Height (in.) | Weight (lbs.) | Quantity | Length (in.) | Width (in.) | Height (in.) |
| Kwikset Multi-Family / Light Commercial | | | | | | | | | |
| Burbank, Carson, and Palmina | | | | | | | | | |
| 407 | 1 | 6.75 | 5.75 | 2.75 | 0.5 | 1 | 7.93 | 6.06 | 3.12 |
| 408 | 1 | 6.75 | 5.75 | 2.75 | 0.5 | 1 | 7.93 | 6.06 | 3.12 |
| 438 | 1 | 6.75 | 5.75 | 2.75 | 1.0 | 1 | 7.93 | 6.06 | 3.12 |
| 439 | 1 | 6.75 | 5.75 | 2.75 | 1.0 | 1 | 7.93 | 6.06 | 3.12 |
| 488 | 1 | 5.18 | 3.00 | 2.43 | 0.55 | 1 | 15.75 | 12.00 | 6.56 |
| Kingston | | | | | | | | | |
| 721KNL | 1 | 6.75 | 5.75 | 2.75 | 1.5 | 1 | 7.93 | 6.06 | 3.12 |
| 733KNL | 1 | 6.75 | 5.75 | 2.75 | 1.5 | 1 | 7.93 | 6.06 | 3.12 |
| 756KNL SMT | 1 | 6.75 | 5.75 | 2.75 | 2.33 | 1 | 7.93 | 6.06 | 3.12 |
| 781KNL SMT | 1 | 6.75 | 5.75 | 2.75 | 2.33 | 1 | 7.93 | 6.06 | 3.12 |
| 788 LVR | 1 | 5.18 | 3.00 | 2.43 | 0.87 | 1 | 15.13 | 12.75 | 3.50 |
| SmartKey Padlock | | | | | | | | | |
| 50MM SmartKey Padlock Std. Shackle | 6 | 2.56 | 1.46 | 4.65 | 1.10 | 6 | 5.39 | 4.80 | 5.04 |
| 50MM SmartKey Padlock Long Shackle | 6 | 2.56 | 1.46 | 4.65 | 1.14 | 6 | 5.39 | 4.80 | 5.04 |



Customer Service Toll Free Line:

(800) 422-LOCK (800) 422-5625

FAX (866) 507-8369

email: kworders@spectrumbands.com

Monday to Friday, 6:00 a.m. to 4:00 p.m. PST

Date: _____ Delivery Address: _____ Contact: _____

PO Number: _____ Phone: _____ Company Name: _____

Job Name: _____ Fax: _____ Address: _____

Notes: _____ Store Number: _____

| Line No. | Function | | Style | | Handing | | Rose | | Finish | | OPTIONS | | | | | Price | Extended Price |
|----------|----------|----------|----------|----------|----------|----------|----------|----------|----------|----------|---------|--------|----------|--------|----------|-------|----------------|
| | Exterior | Interior | Exterior | Interior | Exterior | Interior | Exterior | Interior | Exterior | Interior | Latch | Strike | Cylinder | Keying | Quantity | | |
| 1 | | | | | | | | | | | | | | | | | |
| 2 | | | | | | | | | | | | | | | | | |
| 3 | | | | | | | | | | | | | | | | | |
| 4 | | | | | | | | | | | | | | | | | |
| 5 | | | | | | | | | | | | | | | | | |
| 6 | | | | | | | | | | | | | | | | | |
| 7 | | | | | | | | | | | | | | | | | |
| 8 | | | | | | | | | | | | | | | | | |
| 9 | | | | | | | | | | | | | | | | | |
| 10 | | | | | | | | | | | | | | | | | |
| 11 | | | | | | | | | | | | | | | | | |
| 12 | | | | | | | | | | | | | | | | | |
| 13 | | | | | | | | | | | | | | | | | |
| 14 | | | | | | | | | | | | | | | | | |
| 15 | | | | | | | | | | | | | | | | | |
| 16 | | | | | | | | | | | | | | | | | |
| 17 | | | | | | | | | | | | | | | | | |
| 18 | | | | | | | | | | | | | | | | | |
| 19 | | | | | | | | | | | | | | | | | |
| 20 | | | | | | | | | | | | | | | | | |

To order service parts, provide service part # and quantity.
How to order questions, refer back to page A:3 for General Information.



Kwikset



PROTECTION THAT LIVES ON
MICROBAN[®]
ANTIMICROBIAL TECHNOLOGY

Kwikset[®] and Microban[®], the global leader in built-in antimicrobial protection, have teamed up to improve the standard for door hardware. Kwikset[®] will now offer antimicrobial protection on select products, inhibiting the growth of bacteria on frequently touched door hardware in your home.

99.9% Cleaner
Than Unprotected Surface

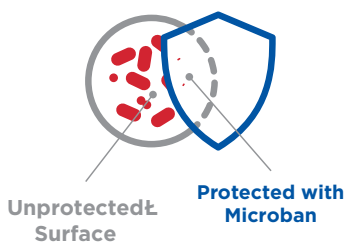

Benefits of Kwikset[®] Door Hardware with Microban[®] Technology

Bacteria can double every 20 minutes on unprotected surfaces, but Kwikset Door Hardware with Microban protection works to continuously fight off microbes.

- Door hardware is 99.9% cleaner than knobs without Microban.
- The antimicrobial coating lasts for the lifetime of the hardware finish, so you can worry less and feel more secure in your home.
- 24/7 Antimicrobial product protection.
- Kwikset with Microban protection resists the growth of a broad spectrum of bacteria.

#1 SELLING U.S. LOCK BRAND*

*Source: TraQline US quarterly brand unit share report, Q4 2006 through Q1 2021

696532-02/2021

Kwikset

HALO



TOUCH

FINGERPRINT SMART LOCK

The Halo Touch Wi-Fi enabled smart lock with fingerprint access technology allows you to simply use your unique fingerprint to lock and unlock your door.



Wi-Fi Enabled



Works with the Kwikset App



Control your lock from your smartphone

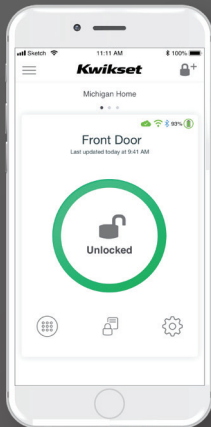

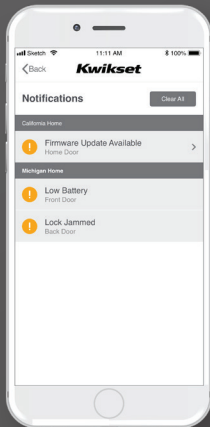

REMOTE ACCESS



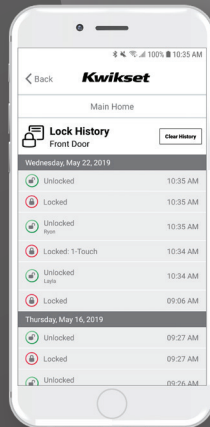

PUSH NOTIFICATIONS

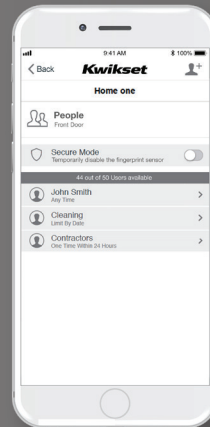

EVENT HISTORY

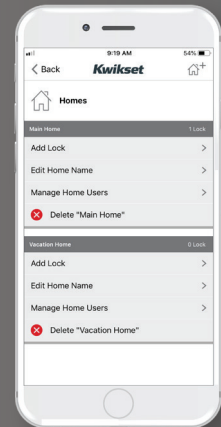

MANAGE USERS



MANAGE MULTIPLE HOMES

#1 SELLING U.S. LOCK BRAND*

*Source: TraQline US quarterly brand unit share report, Q4 2006 through Q1 2021

Specifications

| | |
|----------------------------------|---|
| Function | Single cylinder deadbolt |
| Door Prep | 2 1/8" diameter bore hole & 1" diameter latch hole |
| Backset | Adjustable 2 3/8" or 2 3/4" |
| Door Thickness | 1 3/4" - 2" automatic adjustment |
| Faceplates | 1" x 2 1/4" round corner standard |
| Strikes | Round corner, 4 hole strike, 2 3/4" x 1 1/8" |
| Latch | Round corner adjustable 2 3/8" x 2 3/4" |
| Bolt | 1" throw, steel deadbolt |
| Door Handing | Reversible |
| Cylinder | SmartKey Security™ |
| Temp Range & Humidity | Temperature Range: Exterior: -40F to 150F Interior: 32F to 130F Humidity: Exterior: 100% condensing Interior: 30% - 95% non-condensing |

Innovative Security

- Up to 100 fingerprints/50 users
- BHMA Grade AAA certified
- 256-bit AES encryption security
- Featuring SmartKey Security™ - protecting against advanced break-in techniques

Easy Installation

- No hub required by connecting directly to your home Wi-Fi network
- Operates on (4) AA batteries
- Installs in minutes using a screwdriver

Warranty

- Lifetime mechanical and finish warranty
- 1 year electronic warranty

How it Works



Dimensions

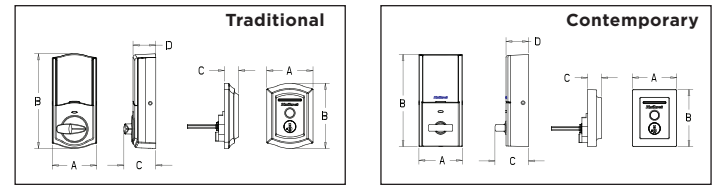

| Traditional | A | B | C | D |
|-------------|------------------|-------------------|------------------|-----------------|
| Interior | 2 23/32" (69 mm) | 5 25/32" (147 mm) | 1 15/16" (49 mm) | 1 7/16" (35 mm) |
| Exterior | 2 13/16" (72 mm) | 3 31/32" (101 mm) | 7/8" (22 mm) | --- |

| Contemporary | A | B | C | D |
|--------------|------------------|-------------------|-----------------|------------------|
| Interior | 2 23/32" (69 mm) | 5 25/32" (147 mm) | 2 2/32" (53 mm) | 1 13/32" (36 mm) |
| Exterior | 2 25/32" (71 mm) | 3 9/16" (91 mm) | 7/8" (22 mm) | --- |

Finishes



Satin Nickel¹⁵
99590-001



Venetian Bronze™¹⁹
99590-002



Satin Nickel¹⁵
99590-003



Matte Black⁵¹⁴
99590-004

FINISH AND
LIFETIME
WARRANTY
MECHANICAL
ONE YEAR
ELECTRONIC WARRANTY



Kwikset

HomeConnect 620

KEYPAD CONNECTED SMART LOCK

With Z-Wave® 700 Chipset



Features

- 10-Button keypad with one-touch locking
- Featuring Smartkey® Security Technology
- Sleek, all metal design
- Z-Wave® 700 for enhanced network security, network pre-enrollment, and extended wireless range and battery life
- Backward compatible with existing Z-Wave panels and hubs
- S2 Secure Network Enrollment
- SmartStart Network Pre-Enrollment

User Codes

- 250 user codes
- Control when people have access with customizable user code schedules
- MasterCode security for improved feature management

Connected Benefits

- Lock/Unlock your doors from anywhere
- View lock status and receive notifications of your lock's activity
- Connect to other devices in the home and create scenes driven by the door lock

#1 SELLING U.S. LOCK BRAND*

*Source: TraQline US quarterly brand unit share report, Q4 2006 through Q1 2021

Specifications

Electrical:

| | |
|--------------------|--------------------------------|
| Input Power | 6V (4 x AA alkaline batteries) |
|--------------------|--------------------------------|

Mechanical:

| | |
|-----------------------|---|
| Door Prep | 1 1/2" & 2 1/8" diameter bore hole & 1" deep latch hole |
| Backset | Adjustable 2 3/8" or 2 3/4" |
| Door Thickness | 1 3/8" - 2" automatic adjustment |
| Faceplates | 1" x 2 1/4" round corner standard |
| Strikes | Round corner strike 1 1/8" x 2 3/4" |
| Latch | Round corner adjustable 2 3/8" x 2 3/4" |
| Bolt | 1" throw, steel deadbolt |
| Door Handing | Reversible |
| Cylinder | SmartKey® Keyway |

Environmental:

| | |
|--------------------------|---|
| Temperature Range | Exterior: -40°F to 150°F Interior: 32°F to 140°F |
| Humidity | Exterior: 100% condensing Interior: 30% - 95% non-condensing |

Finishes



Satin Nickel 15



Venetian Bronze 11P



Polished Brass 3



Satin Nickel 15



Venetian Bronze 11P



Polished Chrome 26



Matte Black 514

Dimensions

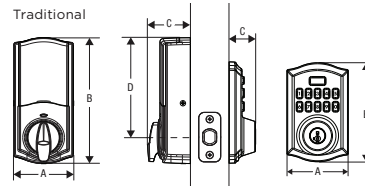

| | Interior | Exterior |
|----------|------------------------|-------------------------|
| A | 2 23/32" (69.1 mm) | 2 13/16" (71.43 mm) |
| B | 5 25/32" (146.6 mm) | 4 9/16" (115.887 mm) |
| C | 1 15/16" (49.5 mm) | 1 1/4" (31.75 mm) |
| D | 4 19/32" (116.5 mm) | --- |

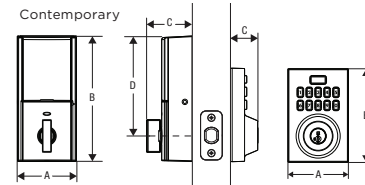

| | Interior | Exterior |
|----------|------------------------|------------------------|
| A | 2 23/32" (69.1 mm) | 2 25/32" (70.64 mm) |
| B | 5 25/32" (146.6 mm) | 4 9/16" (109.53 mm) |
| C | 2 1/8" (53.97 mm) | 1 1/4" (31.75 mm) |
| D | 4 1/2" (114.3 mm) | --- |

Easy Installation

- Replaces existing door hardware with just a screwdriver
- No hard wiring needed
- Operates on 4 x AA alkaline batteries

Innovative Security

- BHMA Grade 2 certified
- Full 128-bit encryption security
- Features SmartKey® Security Re-Key Technology with BumpGuard™ Protection
- Revolutionary tapered deadbolt design—enables misaligned doors to lock without pulling and pushing your door shut
- Supports S2 Secure Network Enrollment

FINISH AND
LIFETIME
WARRANTY
MECHANICAL
ONE YEAR
ELECTRONIC WARRANTY

Kwikset

19701 DaVinci, Lake Forest, CA 92610 • Kwikset.com • 1-800-327-LOCK

© 2020 Spectrum Brands, Inc. Kwikset is a trademark of Spectrum Brands, Inc. Lake Forest, CA 92610 • 634245-12/2020

Kwikset



Introducing PRAGUE

Featuring  **SMARTKEY
SECURITY™**



The Prague handleset has a sleek contemporary design that compliments transitional and modern homes. The clean lines and soft curves of this handleset bring style to any home while maintaining superior security.

- Features SmartKey Security™ Technology
- ANSI/BHMA Certified Highest Security Deadbolt
- Kwikset with Microban provides 24/7 anti-microbial product protection
- Low Profile Deadbolt Design
- Lifetime Mechanical & Finish Warranty

PROTECTION THAT LIVES ON
MICROBAN
ANTIMICROBIAL TECHNOLOGY

#1 SELLING U.S. LOCK BRAND*

*Source: TraQline US quarterly brand unit share report, Q4 2006 through Q1 2021

Specifications

| | |
|-----------------------|---|
| Door Prep | Cross Bore 2 1/8". Edge Bore 1" Latch Face 1" x 2 1/4" |
| Backset | Adjustable 2 3/8" or 2 3/4" |
| Door Thickness | 1 3/4" Standard. Thick door service part available for up to 2 1/4" |
| Faceplates | 1" x 2 1/4". Square, round and drive-in included |
| Strikes | <ul style="list-style-type: none"> • Deadbolt: 1 1/8" x 2 3/4". Specify round or square • Handle: 2 1/4" full lip round or square |
| Bolt | <ul style="list-style-type: none"> • Deadbolt: 1" throw • Handle: 1/2" throw |
| Cylinder | SmartKey Security™ |
| Door Handing | Reversible for right or left-hand doors |
| ANSI/BHMA | Deadbolt - A156.39 Grade AAA Certified |
| UL | N/A |
| ADA | N/A |
| Warranty | Lifetime mechanical and lifetime finish |

Dimensions

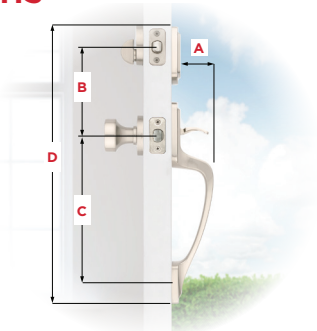

| Dimensions | A | B | C | D |
|------------|----------|--------|---------------------------------|-----------|
| Prague | 2 25/32" | 5 1/2" | 8 13/32" through 9 11/16" | 17 23/32" |

Finishes



26
Polished
Chrome



15
Satin
Nickel



11P
Venetian
Bronze



514
Matte
Black

NEW Adjustable Throughbolt

Vertical and horizontal slide designed for a guaranteed fit

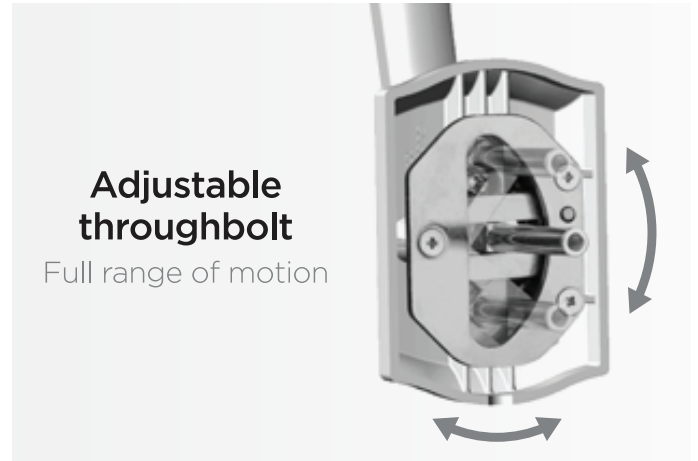

Adjustable throughbolt

Full range of motion

Functions



Handleset (Single-Cylinder)

Latch bolt operated by thumb piece outside and lever inside. Deadbolt operated by key outside and thumb turn inside .

- 818 SMT



Handleset (Dummy)

Handle and lever act as a pull only. For inactive leaf or double doors. No operation.

- 819



Handle Only

Latch bolt operated by thumb piece outside. Exterior Only.

- 814

Kwikset



SINGAPORE LEVER

The Singapore Lever has a modern look and clean lines that are suited for the design conscious consumer. This lever is easy to install and has a custom high quality look that can feature either a round or square rose at an affordable price.

- Features New Advanced SmartKey Security™ Technology
- ANSI/BHMA Grade AAA: Highest Residential Security/Durability/Finish
- Unique Thin-Edge/Flat Face Lever and Square Shank Design
- Kwikset with Microban provides 24/7 antimicrobial product protection
- Perfectly Pairs with our Robust Contemporary Portfolio



Signature Series



Singapore Lever with SmartKey Security round rose in Matte Black



Singapore Lever with SmartKey Security square rose in Polished Chrome

#1 SELLING U.S. LOCK BRAND*

*Source: TraQline US quarterly brand unit share report, Q4 2006 through Q1 2021

Specifications

| | |
|-----------------------|--|
| Door Prep | Cross Bore 2 1/8" or 1 1/2". Edge Bore 1" |
| Backset | Adjustable 2 3/8" or 2 3/4" |
| Door Thickness | 1 3/8" - 1 3/4" Doors standard Thick door service part available for up to 2 1/8" |
| Cylinder | SmartKey Security™ |
| Faceplates | 1" x 2 1/4" Specify round corner, square corner or drive-in |
| Strikes | 2 1/4" full lip. Specify square or round |
| Bolt | 1/2" Throw |

| | |
|---------------------|--|
| ANSI/BHMA | Grade AAA Certified: Finish/Durability/Security |
| UL | Optional 20 minute UL fire rating available, except inactive functions |
| Door Handing | Reversible for right or left hand doors |
| ADA | 720 & 730 functions are in compliance with the American National Standards Institute (ANSI A117.1) |
| Rose | Specify round (RDT) or square (SQT) |
| Warranty | Lifetime Mechanical and Lifetime Finish |

Functions



Passage/Hall/Closet: Both levers always free.
- 720SAL



Privacy/Bed/Bath: Both levers locked or unlocked by push-button inside. Outside lever unlocked by emergency key.
- 730SAL



Keyed Entry Lever: Both sides locked or unlocked by key outside or turn-button inside.
- 740SAL



Half Dummy Trim, Surface Mounted:
For doors where only a pull is required. No operation.
- 788SAL

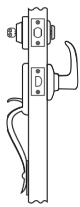

Interior Pack: Inside lever of handleset.
800/801/802 Handlesets:
- 966SAL: Single-Cylinder
- 968SAL: Dummy
818/819 Handlesets:
- 971SAL: Single-Cylinder
- 973SAL: Dummy

Dimensions

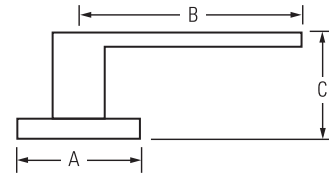

| Design | A | B | C | C (Keyed) |
|-----------------------|---------|---------|---------|-----------|
| Singapore Round Rose | 2 1/16" | 4 7/32" | 2 1/2 " | 2 1/4" |
| Singapore Square Rose | 2 1/16" | 4 7/32" | 2 1/2 " | 2 1/4" |



Singapore Lever with round rose in Venetian Bronze

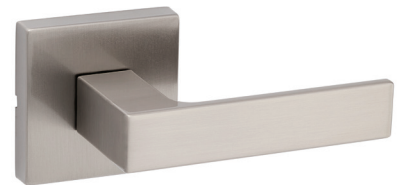

Singapore Lever with square rose in Satin Nickel

Finishes



Matte Black 514



Satin Nickel 15

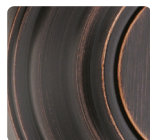

Venetian Bronze 11p



Polished Chrome 26





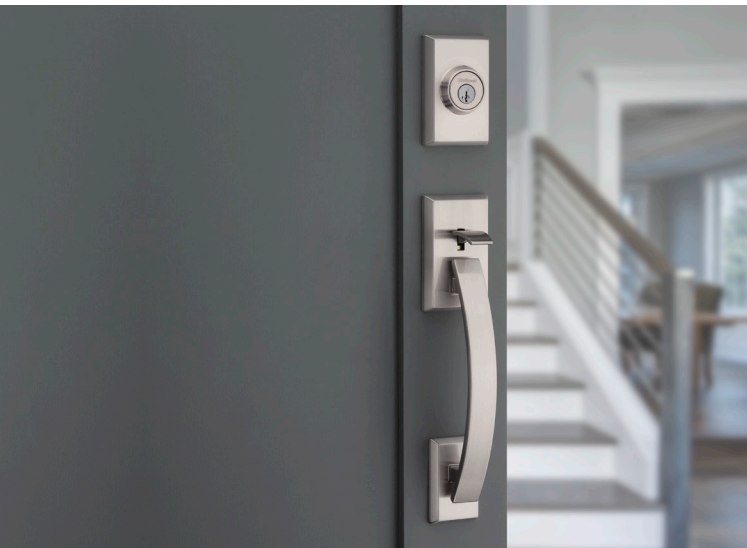

Signature Series

Superior Security Features

- ANSI/BHMA Grade 1 Certified 980/985 Deadbolt
- SmartKey Security - providing superior security against advanced break-in techniques.

Elegant Styles And Finishes

- Traditional to Contemporary Styles

Warranty

- Lifetime Mechanical
- Lifetime Finish

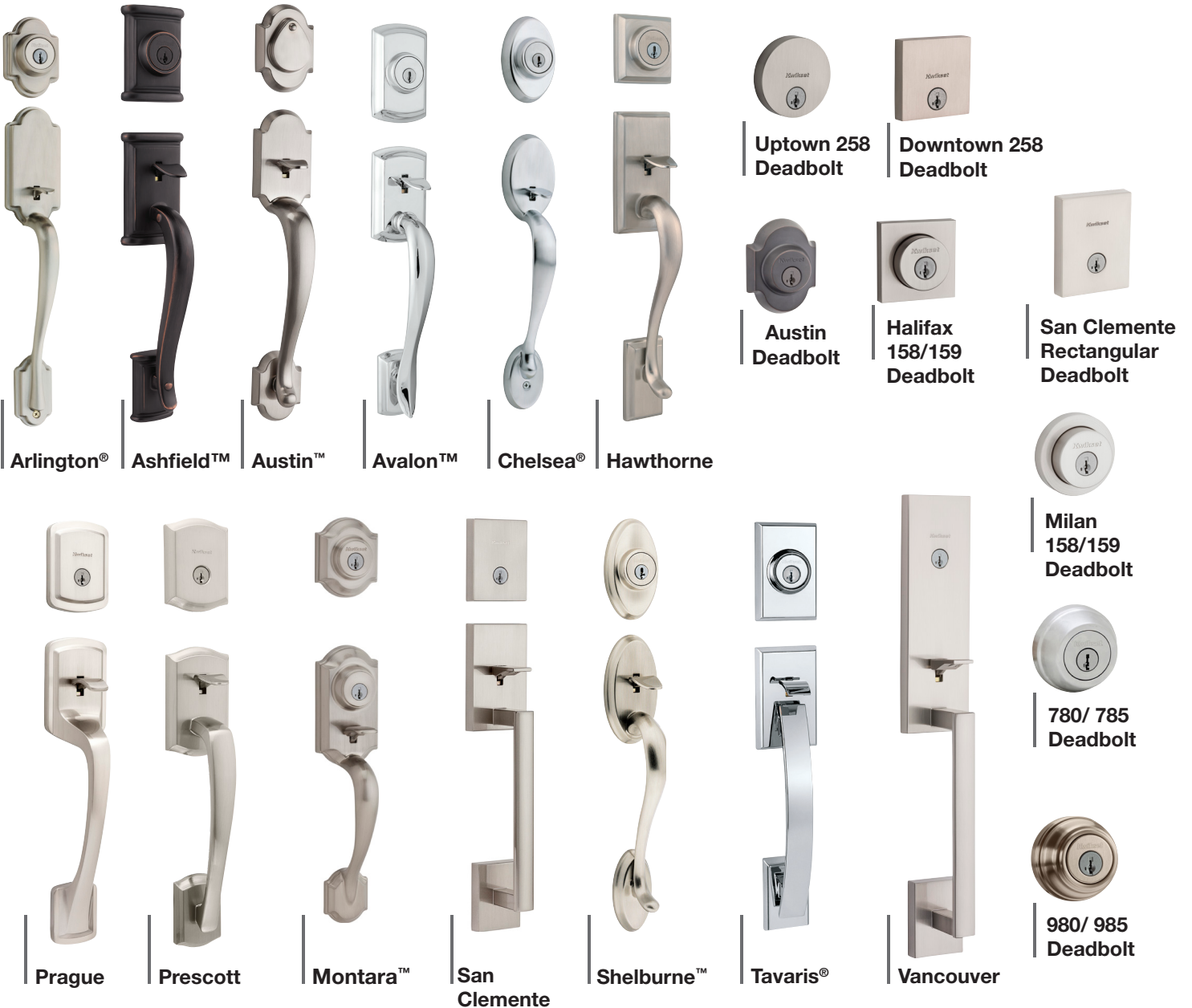

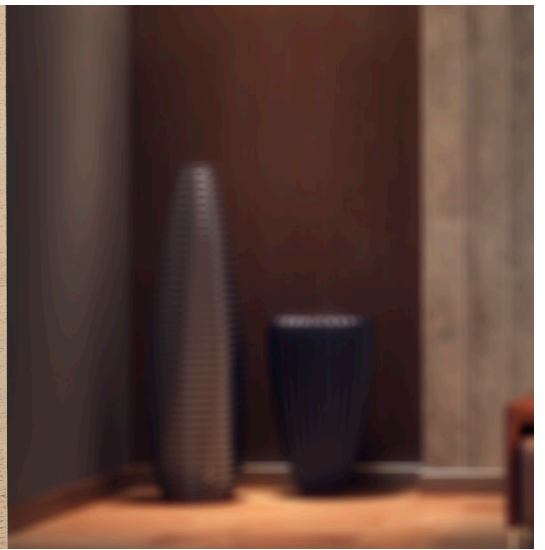

Signature Series



| Abbey®



| Cameron®



| Hancock®



| Laurel®



| Pismo



| Ashfield™



| Austin



| Commonwealth®



| Halifax®



| Halifax®
San Clemente Trim



| Katella



| Lido®



| Lisbon



| Milan®



| Montreal



| Pembroke™



| Singapore



| Sydney®



| Tustin®

Vancouver*



Prague*



San Clemente



Ashfield™



| Vancouver | Model | Function | Finish | | | | | | | | Case | | |
|------------|-----------------|----------|--------|-----|---|----------|----------|-----|----|----------|------|----------|---|
| | | | 3 | L03 | 5 | 11P | 15 | 15A | 26 | 26D | 514 | Qty | |
| 818VNH SMT | Single Cylinder | | | | | \$315.00 | \$315.00 | | | \$315.00 | | \$325.50 | 4 |
| 819VNH | Dummy | | | | | \$283.50 | \$283.50 | | | \$283.50 | | \$294.00 | 4 |

| Prague | Model | Function | Finish | | | | | | | | Case | | |
|------------|-----------------|----------|--------|-----|---|----------|----------|-----|----|----------|------|----------|---|
| | | | 3 | L03 | 5 | 11P | 15 | 15A | 26 | 26D | 514 | Qty | |
| 818PGH SMT | Single Cylinder | | | | | \$303.50 | \$303.50 | | | \$303.50 | | \$314.00 | 4 |
| 819PGH | Dummy | | | | | \$272.00 | \$272.00 | | | \$272.00 | | \$282.50 | 4 |
| 814PGH | Handle Only | | | | | \$232.10 | \$232.10 | | | \$232.10 | | \$242.60 | 4 |

| San Clemente | Model | Function | Finish | | | | | | | | Case | | |
|--------------|----------------------------|----------|--------|-----|---|----------|----------|-----|----|----------|----------|----------|---|
| | | | 3 | L03 | 5 | 11P | 15 | 15A | 26 | 26D | 514 | Qty | |
| 818SCE SMT | Single Cylinder | | | | | \$303.50 | \$303.50 | | | \$303.50 | \$303.50 | \$314.00 | 4 |
| 818SCE SMC | Single Cylinder | | | | | | \$306.00 | | | \$306.00 | | \$316.50 | 4 |
| 819SCE | Dummy | | | | | \$272.00 | \$272.00 | | | \$272.00 | \$272.00 | \$282.50 | 4 |
| 814SCE | Handle Only† | | | | | \$232.10 | \$232.10 | | | \$232.10 | \$232.10 | \$242.60 | 4 |
| 815SCE | Handle with Halifax Lever† | | | | | \$305.60 | \$305.60 | | | \$305.60 | \$305.60 | \$316.10 | 4 |

| Ashfield® | Model | Function | Finish | | | | | | | | Case | | |
|------------|-----------------|----------|--------|-----|---|----------|----------|-----|----|-----|------|----------|---|
| | | | 3 | L03 | 5 | 11P | 15 | 15A | 26 | 26D | 514 | Qty | |
| 800ADH | Single Cylinder | | | | | \$290.90 | \$290.90 | | | | | \$301.40 | 4 |
| 800ADH SMT | Single Cylinder | | | | | \$290.90 | \$290.90 | | | | | \$301.40 | 4 |
| 801ADH | Double Cylinder | | | | | \$296.20 | \$296.20 | | | | | \$306.70 | 4 |
| 801ADH SMT | Double Cylinder | | | | | \$296.20 | \$296.20 | | | | | \$306.70 | 4 |
| 802ADH | Dummy | | | | | \$259.40 | \$259.40 | | | | | \$269.90 | 4 |

NOTE: Handlesets ordered LIP only

†Denotes handleset without deadbolt



| Austin™ | Model | Function | Finish | | | | | | | | Case | | | |
|---------|------------|-----------------|--------|-----|---|----------|----------|-----|----|-----|------|-----|--|---|
| | | | 3 | L03 | 5 | 11P | 15 | 15A | 26 | 26D | 514 | Qty | | |
| | 800AUH SMT | Single Cylinder | | | | \$290.90 | \$290.90 | | | | | | | 4 |
| | 801AUH SMT | Double Cylinder | | | | \$296.20 | \$296.20 | | | | | | | 4 |
| | 802AUH | Dummy | | | | \$259.40 | \$259.40 | | | | | | | 4 |
| | 814AUH | Handle Only† | | | | \$219.50 | \$219.50 | | | | | | | 4 |

| Avalon™ | Model | Function | Finish | | | | | | | | Case | | | |
|---------|------------|-----------------|--------|-----|---|----------|----------|-----|----|-----|------|----------|--|---|
| | | | 3 | L03 | 5 | 11P | 15 | 15A | 26 | 26D | 514 | Qty | | |
| | 800AVH | Single Cylinder | | | | \$290.90 | \$290.90 | | | | | \$301.40 | | 4 |
| | 800AVH SMT | Single Cylinder | | | | \$290.90 | \$290.90 | | | | | \$301.40 | | 4 |
| | 801AVH | Double Cylinder | | | | \$296.20 | \$296.20 | | | | | \$306.70 | | 4 |
| | 801AVH SMT | Double Cylinder | | | | \$296.20 | \$296.20 | | | | | \$306.70 | | 4 |
| | 802AVH | Dummy | | | | \$259.40 | \$259.40 | | | | | \$269.90 | | 4 |
| | 814AVH | Handle Only† | | | | \$219.50 | \$219.50 | | | | | | | 4 |

| Montara™ | Model | Function | Finish | | | | | | | | Case | | | |
|----------|------------|-----------------|----------|-----|---|----------|----------|-----|----|-----|------|-----|--|---|
| | | | 3 | L03 | 5 | 11P | 15 | 15A | 26 | 26D | 514 | Qty | | |
| | 553MNH SMT | Single Cylinder | \$269.90 | | | \$290.90 | \$290.90 | | | | | | | 4 |
| | 554MNH SMT | Double Cylinder | \$275.20 | | | \$296.20 | \$296.20 | | | | | | | 4 |

| Shelburne™ | Model | Function | Finish | | | | | | | | Case | | | |
|------------|-----------|-----------------|--------|-----|---|----------|----------|-----|----|-----|------|-----|--|---|
| | | | 3 | L03 | 5 | 11P | 15 | 15A | 26 | 26D | 514 | Qty | | |
| | 800SE | Single Cylinder | | | | \$274.10 | \$274.10 | | | | | | | 4 |
| | 800SE SMT | Single Cylinder | | | | \$274.10 | \$274.10 | | | | | | | 4 |
| | 801SE | Double Cylinder | | | | \$279.40 | \$279.40 | | | | | | | 4 |
| | 801SE SMT | Double Cylinder | | | | \$279.40 | \$279.40 | | | | | | | 4 |
| | 802SE | Dummy | | | | \$242.60 | \$242.60 | | | | | | | 4 |
| | 814SE | Handle Only† | | | | \$202.70 | \$202.70 | | | | | | | 4 |

NOTE: Handlesets ordered LIP only
 †Denotes handleset without deadbolt

Hawthorne



Tavaris®



Prescott



| Hawthorne | Model | Function | Finish | | | | | | | | Case | | |
|-----------|-----------------|----------|--------|-----|---|----------|----------|----------|----|-----|------|----------|---|
| | | | 3 | L03 | 5 | 11P | 15 | 15A | 26 | 26D | 514 | Qty | |
| 800HE | Single Cylinder | | | | | \$274.10 | \$274.10 | \$274.10 | | | | \$284.60 | 4 |
| 800HE SMT | Single Cylinder | | | | | \$274.10 | \$274.10 | \$274.10 | | | | \$284.60 | 4 |
| 800HE SMC | Single Cylinder | | | | | \$276.60 | \$276.60 | | | | | | 4 |
| 801HE | Double Cylinder | | | | | \$279.40 | \$279.40 | \$279.40 | | | | \$289.90 | 4 |
| 801HE SMT | Double Cylinder | | | | | \$279.40 | \$279.40 | \$279.40 | | | | \$289.90 | 4 |
| 802HE | Dummy | | | | | \$242.60 | \$242.60 | \$242.60 | | | | \$253.10 | 4 |
| 814HE | Handle Only† | | | | | \$202.70 | \$202.70 | | | | | | 4 |

| Prescott | Model | Function | Finish | | | | | | | | Case | | |
|------------|------------------------|----------|--------|----------|---|----------|----------|-----|----|-----|------|----------|---|
| | | | 3 | L03 | 5 | 11P | 15 | 15A | 26 | 26D | 514 | Qty | |
| 818PTH SMT | Single Cylinder | | | \$274.10 | | \$274.10 | \$274.10 | | | | | \$284.60 | 4 |
| 819PTH | Dummy | | | \$242.60 | | \$242.60 | \$242.60 | | | | | \$253.10 | 4 |
| 814PTH | Handle Only | | | \$202.70 | | \$202.70 | \$202.70 | | | | | \$213.20 | 4 |
| 815PTH | Handleset with Tustin | | | \$276.20 | | \$276.20 | \$276.20 | | | | | | 4 |
| 815PTH | Handleset with Hancock | | | \$264.60 | | \$264.60 | \$264.60 | | | | | | 4 |

| Tavaris® | Model | Function | Finish | | | | | | | | Case | | |
|------------|-----------------|----------|--------|-----|---|----------|----------|-----|----------|----------|----------|-----|---|
| | | | 3 | L03 | 5 | 11P | 15 | 15A | 26 | 26D | 514 | Qty | |
| 800TVH | Single Cylinder | | | | | \$274.10 | \$274.10 | | \$274.10 | \$274.10 | | | 4 |
| 800TVH SMT | Single Cylinder | | | | | \$274.10 | \$274.10 | | \$274.10 | \$274.10 | \$284.60 | | 4 |
| 801TVH | Double Cylinder | | | | | \$279.40 | \$279.40 | | \$279.40 | \$279.40 | | | 4 |
| 801TVH SMT | Double Cylinder | | | | | \$279.40 | \$279.40 | | \$279.40 | \$279.40 | | | 4 |
| 802TVH | Dummy | | | | | \$242.60 | \$242.60 | | \$242.60 | \$242.60 | \$253.10 | | 4 |
| 814TVH | Handle Only† | | | | | \$202.70 | \$202.70 | | \$202.70 | \$202.70 | \$213.20 | | 4 |

NOTE: Handlesets ordered LIP only
 †Denotes handleset without deadbolt

Arlington®



Chelsea®



| Arlington® | Model | Function | Finish | | | | | | | | Case | |
|------------|-----------|------------------------|--------|----------|----------|----------|----------|----------|----|-----|------|-----|
| | | | 3 | L03 | 5 | 11P | 15 | 15A | 26 | 26D | 514 | Qty |
| | 800AN | Single Cylinder | | \$226.80 | \$226.80 | \$226.80 | \$226.80 | \$226.80 | | | | 4 |
| | 800AN SMT | Single Cylinder | | \$226.80 | \$226.80 | \$226.80 | \$226.80 | \$226.80 | | | | 4 |
| | 801AN | Double Cylinder | | \$232.10 | \$232.10 | \$232.10 | \$232.10 | \$232.10 | | | | 4 |
| | 801AN SMT | Double Cylinder | | \$232.10 | \$232.10 | \$232.10 | \$232.10 | \$232.10 | | | | 4 |
| | 802AN | Dummy | | \$195.30 | \$195.30 | \$195.30 | \$195.30 | \$195.30 | | | | 4 |
| | 814AN | Handle Only† | | \$155.40 | | \$155.40 | \$155.40 | | | | | 4 |
| | 815AN | Handleset with Tustin | | \$228.90 | | \$228.90 | \$228.90 | | | | | 6 |
| | 815AN | Handleset with Hancock | | \$217.30 | | \$217.30 | \$217.30 | | | | | 6 |

| Chelsea® | Model | Function | Finish | | | | | | | | Case | |
|----------|-----------|-------------------------|--------|----------|----------|----------|----------|----------|----------|----------|------|-----|
| | | | 3 | L03 | 5 | 11P | 15 | 15A | 26 | 26D | 514 | Qty |
| | 800CE | Single Cylinder | | \$226.80 | \$226.80 | \$226.80 | \$226.80 | \$226.80 | \$226.80 | \$226.80 | | 4 |
| | 800CE SMT | Single Cylinder | | \$226.80 | \$226.80 | \$226.80 | \$226.80 | \$226.80 | \$226.80 | \$226.80 | | 4 |
| | 800CE SMC | Single Cylinder | | | | \$229.30 | \$229.30 | | | | | 4 |
| | 801CE | Double Cylinder | | \$232.10 | \$232.10 | \$232.10 | \$232.10 | \$232.10 | \$232.10 | \$232.10 | | 4 |
| | 801CE SMT | Double Cylinder | | \$232.10 | \$232.10 | \$232.10 | \$232.10 | \$232.10 | \$232.10 | \$232.10 | | 4 |
| | 802CE | Dummy | | \$195.30 | \$195.30 | \$195.30 | \$195.30 | \$195.30 | \$195.30 | \$195.30 | | 4 |
| | 814CE | Handle Only† | | \$155.40 | | \$155.40 | \$155.40 | | \$155.40 | | | 4 |
| | 815CE | Handleset† with Tustin | | \$228.90 | | \$228.90 | \$228.90 | | | | | 6 |
| | 815CE | Handleset† with Hancock | | \$217.30 | | \$217.30 | \$217.30 | | | | | 6 |

NOTE: Handlesets ordered LIP only
 †Denotes handleset without deadbolt

INTERIOR PACKS FOR TRADITIONAL 800/801/802 HANDLESETS

| Model | Function | Series | | | |
|---------|-----------------|--------------------------|----------------|--------------|--------------|
| | | Signature Lever & Laurel | Signature Knob | Kwiset Lever | Kwikset Knob |
| 966 | Single Cylinder | \$75.00 | \$62.20 | \$67.50 | \$54.60 |
| 967 | Double Cylinder | \$99.70 | \$86.90 | \$86.70 | \$73.80 |
| 967 SMT | Double Cylinder | \$99.70 | \$86.90 | \$86.70 | \$73.80 |
| 968 | Dummy | \$62.20 | \$49.40 | \$57.00 | \$44.10 |

| Handleset Interior Pack Finish Options | | 3 | L03 | 5 | 11P | 15 | 15A | 26 | 26D | 514 | Qty |
|---|--------------------|---|-----|---|-----|----|-----|----|-----|-----|-----|
| Kwikset <i>Signature Series</i> | Abbey Knob | • | | | | | | | • | | 4 |
| | Ashfield Lever | | | | • | • | | • | | • | 12 |
| | Austin Lever | | | | • | • | | | | | 12 |
| | Cameron Knob | • | | | • | • | | | | | 4 |
| | Commonwealth Lever | • | | • | • | • | | | • | • | 4 |
| | Halifax Lever | | | | • | • | | • | • | • | 12 |
| | Hancock Knob | • | | • | • | • | • | • | • | • | 4 |
| | Katella Lever* | | | | | ○ | | | | ○ | 4 |
| | Laurel Knob | | | | • | • | | • | | • | 4 |
| | Lido Lever | • | | • | • | • | • | | • | | 4 |
| Kwikset | Lisbon Lever | | | | • | • | | • | • | • | 12 |
| | Milan Lever | | | | • | • | | • | • | • | 12 |
| | Montreal Lever | | | | • | • | | • | • | • | 12 |
| | Pembroke Lever | | | | • | • | | • | | • | 12 |
| | Pismo Knob | | | | • | • | | • | • | • | 4 |
| | Singapore Lever | | | | • | • | | • | | • | 4 |
| | Sydney Lever | | | | • | • | • | • | • | • | 12 |
| | Tustin Lever | • | | • | • | • | • | • | • | ○ | 12 |
| | Aliso Knob | • | | | • | • | | • | | | 12 |
| | Balboa Lever | • | | • | • | • | | • | • | | 4 |
| | Breton Lever | | | | | • | | • | | • | 12 |
| | Casey Lever | | | | | • | | • | | • | 12 |
| | Cove Knob | • | | | • | • | | • | • | | 4 |
| | Delta Lever | • | | | • | • | | • | • | | 12 |
| | Dorian Lever | • | | • | • | • | | • | • | | 12 |
| | Ladera RDT Lever | | | | • | • | | • | • | | 12 |
| | Ladera SQT Lever | | | | | • | | • | • | • | 12 |
| | Polo Knob | • | | • | • | • | • | • | • | | 4 |
| Tylo Knob | • | | • | • | • | | • | • | | 12 | |

SECTIONAL INTERIOR PACKS FOR LOW PROFILE 818/819 HANDLESETS

| Model | Function | Series | | | |
|-------|-----------------|-----------------|----------------|--------------|--------------|
| | | Signature Lever | Signature Knob | Kwiset Lever | Kwikset Knob |
| 971 | Single Cylinder | \$75.00 | \$62.20 | \$67.50 | |
| 973 | Dummy | \$62.20 | \$49.40 | \$57.00 | |

| Handleset Interior Pack Finish Options | | 3 | L03 | 5 | 11P | 15 | 15A | 26 | 26D | 514 | Qty |
|---|-------------------|---|-----|---|-----|----|-----|----|-----|-----|-----|
| Kwikset <i>Signature Series</i> | Halifax Lever | | | | • | • | | • | • | • | 4 |
| | Halifax RCT Lever | | | | | • | | • | | • | 4 |
| | Hancock Knob | • | | | • | • | | | | • | 4 |
| | Katella Lever* | | | | | • | | | | • | 4 |
| | Lisbon Lever | | | | • | • | | • | • | • | 4 |
| | Milan Lever | | | | • | • | | • | • | • | 4 |
| | Montreal Lever | | | | • | • | | • | • | • | 4 |
| | Pismo Knob | | | | • | • | | • | | • | 4 |
| | Singapore Lever | | | | • | • | | • | • | • | 4 |
| | Sydney Lever | | | | • | • | • | • | • | • | 4 |
| Kwikset | Tustin Lever | • | | | • | • | | | | • | 4 |
| | Breton Lever | | | | | • | | • | | • | 4 |
| | Casey Lever | | | | | • | | • | | • | 4 |

Note: Square (SQT) or Round (RDT) rose options available ○ Only available in 966 Function

*Coming soon

FULL SQUARE INTERIOR PACKS FOR LOW PROFILE 818/819 HANDLESETS



| Model | Function | Series | | | |
|---------|-----------------|-----------------|----------------|---------------|--------------|
| | | Signature Lever | Signature Knob | Kwikset Lever | Kwikset Knob |
| 971 SQF | Single Cylinder | \$85.50 | | | |
| 973 SQF | Dummy | \$69.40 | | | |

| Handleset Interior Pack Finish Options | 3 | L03 | 5 | 11P | 15 | 15A | 26 | 26D | 514 | Qty |
|--|---|-----|---|-----|----|-----|----|-----|-----|-----|
|--|---|-----|---|-----|----|-----|----|-----|-----|-----|

| | | | | | | | | | | |
|---|--|--|--|---|---|--|---|--|---|---|
| Kwikset <i>Signature Series</i> Halifax Lever | | | | • | • | | • | | • | 4 |
|---|--|--|--|---|---|--|---|--|---|---|

Note: Only square (SQF) rose option available

MONTARA INTERIOR PACKS

| Model | Function | Series | | | |
|-------|-----------------|-----------------|----------------|---------------|--------------|
| | | Signature Lever | Signature Knob | Kwikset Lever | Kwikset Knob |
| 978 | Single Cylinder | \$79.30 | \$65.30 | | \$56.80 |
| 979 | Double Cylinder | \$104.00 | \$90.00 | | \$76.00 |

| Montara Handleset Interior Pack Finish Options | 3 | L03 | 5 | 11P | 15 | 15A | 26 | 26D | 514 | Qty |
|--|---|-----|---|-----|----|-----|----|-----|-----|-----|
|--|---|-----|---|-----|----|-----|----|-----|-----|-----|

| | | | | | | | | | | |
|--|---|--|--|---|---|--|--|--|--|----|
| Kwikset <i>Signature Series</i> Cameron Knob | • | | | • | • | | | | | 12 |
| Juno Knob | • | | | • | • | | | | | 12 |
| Lido Lever | • | | | • | • | | | | | 12 |
| Tustin Lever | • | | | • | • | | | | | 12 |
| Kwikset Cove Knob | • | | | • | • | | | | | 12 |
| Polo Knob | • | | | • | • | | | | | 12 |
| Tylo Knob | • | | | | | | | | | 12 |

Ashfield™



| Model | Function | Finish | | | | | | | | | | Case Qty |
|------------|----------------|--------|-----|---|----------|----------|-----|----------|-----|----------|--|----------|
| | | 3 | L03 | 5 | 11P | 15 | 15A | 26 | 26D | 514 | | |
| 720ADL | Hall/Closet | | | | \$65.90 | \$65.90 | | \$65.90 | | \$69.20 | | 12 |
| 725ADL | Hall/Closet UL | | | | \$71.90 | \$71.90 | | \$71.90 | | \$75.20 | | 12 |
| 730ADL | Bed/Bath | | | | \$69.20 | \$69.20 | | \$69.20 | | \$72.50 | | 12 |
| 735ADL | Bed/Bath UL | | | | \$75.20 | \$75.20 | | \$75.20 | | \$78.50 | | 12 |
| 740ADL SMT | Entry | | | | \$116.90 | \$116.90 | | \$116.90 | | \$120.20 | | 12 |
| 745ADL SMT | Entry UL | | | | \$122.90 | \$122.90 | | \$122.90 | | \$126.20 | | 12 |
| 788ADL | Half Dummy | | | | \$32.95 | \$32.95 | | \$32.95 | | \$34.60 | | 20 |

Austin



| Model | Function | Finish | | | | | | | | | | Case Qty |
|------------|-------------|--------|-----|---|----------|----------|-----|----|-----|-----|--|----------|
| | | 3 | L03 | 5 | 11P | 15 | 15A | 26 | 26D | 514 | | |
| 720AUL | Hall/Closet | | | | \$74.60 | \$74.60 | | | | | | 12 |
| 730AUL | Bed/Bath | | | | \$77.90 | \$77.90 | | | | | | 12 |
| 740AUL SMT | Entry | | | | \$125.60 | \$125.60 | | | | | | 12 |
| 788AUL | Half Dummy | | | | \$37.30 | \$37.30 | | | | | | 20 |

Pembroke™



| Model | Function | Finish | | | | | | | | | | Case Qty |
|------------|----------------|--------|-----|---|----------|----------|-----|----------|-----|----------|--|----------|
| | | 3 | L03 | 5 | 11P | 15 | 15A | 26 | 26D | 514 | | |
| 720PML | Hall/Closet | | | | \$65.90 | \$65.90 | | \$65.90 | | \$69.20 | | 12 |
| 725PML | Hall/Closet UL | | | | \$71.90 | \$71.90 | | \$71.90 | | \$75.20 | | 12 |
| 730PML | Bed/Bath | | | | \$69.20 | \$69.20 | | \$69.20 | | \$72.50 | | 12 |
| 735PML | Bed/Bath UL | | | | \$75.20 | \$75.20 | | \$75.20 | | \$78.50 | | 12 |
| 740PML SMT | Entry | | | | \$116.90 | \$116.90 | | \$116.90 | | \$120.20 | | 12 |
| 745PML SMT | Entry UL | | | | \$122.90 | \$122.90 | | \$122.90 | | \$126.20 | | 12 |
| 788PML | Half Dummy | | | | \$32.95 | \$32.95 | | \$32.95 | | \$34.60 | | 20 |

Halifax™



| Model | Function | Finish | | | | | | | | | | Case Qty |
|-------------|----------------|----------|----------|----------|----------|----------|----------|----------|----------|----------|----------|----------|
| | | 11P | 15 | 26 | 26D | 514 | 11Px15 | 11Px26 | 15x26 | 514x15 | 514x26 | |
| 720HFL | Hall/Closet | \$65.90 | \$65.90 | \$65.90 | \$65.90 | \$69.20 | \$65.90 | \$65.90 | \$65.90 | \$69.20 | \$69.20 | 12 |
| 725HFL | Hall/Closet UL | \$71.90 | \$71.90 | \$71.90 | \$71.90 | \$75.20 | | | | | | 12 |
| 730HFL | Bed/Bath | \$69.20 | \$69.20 | \$69.20 | \$69.20 | \$72.50 | \$69.20 | \$69.20 | \$69.20 | \$72.50 | \$72.50 | 12 |
| 740HFL SMT | Entry | \$116.90 | \$116.90 | \$116.90 | \$116.90 | \$120.20 | \$116.90 | \$116.90 | \$116.90 | \$120.20 | \$120.20 | 12 |
| 740HFL SMC* | Entry | | \$119.40 | \$119.40 | | \$122.70 | | | | | | 12 |
| 745HFL SMT | Entry UL | \$122.90 | \$122.90 | \$122.90 | \$122.90 | \$126.20 | | | | | | 12 |
| 788HFL | Half Dummy | \$32.95 | \$32.95 | \$32.95 | \$32.95 | \$34.60 | | | | | | 20 |

NOTE: Can be ordered with (RDT) Round Rose or (SQT) Square Rose option. Example - 720HFL RDT 11P, *(SQT) Square Rose Only

**Halifax™
San Clemente
Trim**



| Model | Function | Function | | | | | | | | | | Case Qty |
|----------------|-------------|----------|----------|----------|-----|----------|--------|--------|-------|--------|--------|----------|
| | | 11P | 15 | 26 | 26D | 514 | 11Px15 | 11Px26 | 15x26 | 514x15 | 514x26 | |
| 720HFL RCT | Hall/Closet | | \$74.20 | \$74.20 | | \$77.50 | | | | | | 12 |
| 730HFL RCT | Bed/Bath | | \$77.50 | \$77.50 | | \$80.80 | | | | | | 12 |
| 740HFL RCT SMT | Entry | | \$125.20 | \$125.20 | | \$128.50 | | | | | | 12 |
| 788HFL RCT | Half Dummy | | \$37.10 | \$37.10 | | \$38.75 | | | | | | 20 |

NOTE: RCT = Rectangular

Lisbon

| | Model | Function | Finish | | | | | | | | Case Qty | | |
|--|------------|-------------|----------|----------|----------|----------|----------|----------|----------|----------|----------|----------|--------|
| | | | 11P | 15 | 26 | 26D | 514 | 11Px15 | 11Px26 | 15x26 | | 514x15 | 514x26 |
|  | 720LSL | Hall/Closet | \$65.90 | \$65.90 | \$65.90 | \$65.90 | \$69.20 | \$65.90 | \$65.90 | \$65.90 | \$69.20 | \$69.20 | 12 |
| | 730LSL | Bed/Bath | \$69.20 | \$69.20 | \$69.20 | \$69.20 | \$72.50 | \$69.20 | \$69.20 | \$69.20 | \$72.50 | \$72.50 | 12 |
| | 740LSL SMT | Entry | \$116.90 | \$116.90 | \$116.90 | \$116.90 | \$120.20 | \$116.90 | \$116.90 | \$116.90 | \$120.20 | \$120.20 | 12 |
| | 788LSL | Half Dummy | \$32.95 | \$32.95 | \$32.95 | \$32.95 | \$34.60 | | | | | | 12 |

NOTE: Can be ordered with (RDT) Round Rose or (SQT) Square Rose option. Example - 720LSL RDT 11P

Milan™

| | Model | Function | Finish | | | | | | | | Case Qty | | |
|--|------------|-------------|----------|----------|----------|----------|----------|----------|----------|----------|----------|----------|--------|
| | | | 11P | 15 | 26 | 26D | 514 | 11Px15 | 11Px26 | 15x26 | | 514x15 | 514x26 |
|  | 720MIL | Hall/Closet | \$65.90 | \$65.90 | \$65.90 | \$65.90 | \$69.20 | \$65.90 | \$65.90 | \$65.90 | \$69.20 | \$69.20 | 12 |
| | 730MIL | Bed/Bath | \$69.20 | \$69.20 | \$69.20 | \$69.20 | \$72.50 | \$69.20 | \$69.20 | \$69.20 | \$72.50 | \$72.50 | 12 |
| | 740MIL SMT | Entry | \$116.90 | \$116.90 | \$116.90 | \$116.90 | \$120.20 | \$116.90 | \$116.90 | \$116.90 | \$120.20 | \$120.20 | 12 |
| | 788MIL | Half Dummy | \$32.95 | \$32.95 | \$32.95 | \$32.95 | \$34.60 | | | | | | 12 |

NOTE: Can be ordered with (RDT) Round Rose or (SQT) Square Rose option. Example - 720MIL SQT 11P

Montreal

| | Model | Function | Finish | | | | | | | | Case Qty | | |
|--|------------|-------------|----------|----------|----------|----------|----------|----------|----------|----------|----------|----------|--------|
| | | | 11P | 15 | 26 | 26D | 514 | 11Px15 | 11Px26 | 15x26 | | 514x15 | 514x26 |
|  | 720MRL | Hall/Closet | \$65.90 | \$65.90 | \$65.90 | \$65.90 | \$69.20 | \$65.90 | \$65.90 | \$65.90 | \$69.20 | \$69.20 | 12 |
| | 730MRL | Bed/Bath | \$69.20 | \$69.20 | \$69.20 | \$69.20 | \$72.50 | \$69.20 | \$69.20 | \$69.20 | \$72.50 | \$72.50 | 12 |
| | 740MRL SMT | Entry | \$116.90 | \$116.90 | \$116.90 | \$116.90 | \$120.20 | \$116.90 | \$116.90 | \$116.90 | \$120.20 | \$120.20 | 12 |
| | 788MRL | Half Dummy | \$32.95 | \$32.95 | \$32.95 | \$32.95 | \$34.60 | | | | | | 12 |

NOTE: Can be ordered with (RDT) Round Rose or (SQT) Square Rose option. Example - 720MRL RDT 11P

Sydney®

| | Model | Function | Finish | | | | | | | | Case Qty | | |
|--|------------|-------------|----------|----------|----------|----------|----------|----------|----------|----------|----------|----------|--------|
| | | | 11P | 15 | 26 | 26D | 514 | 11Px15 | 11Px26 | 15x26 | | 514x15 | 514x26 |
|  | 720SYL | Hall/Closet | \$65.90 | \$65.90 | \$65.90 | \$65.90 | \$69.20 | \$65.90 | \$65.90 | \$65.90 | \$69.20 | \$69.20 | 12 |
| | 730SYL | Bed/Bath | \$69.20 | \$69.20 | \$69.20 | \$69.20 | \$72.50 | \$69.20 | \$69.20 | \$69.20 | \$72.50 | \$72.50 | 12 |
| | 740SYL SMT | Entry | \$116.90 | \$116.90 | \$116.90 | \$116.90 | \$120.20 | \$116.90 | \$116.90 | \$116.90 | \$120.20 | \$120.20 | 12 |
| | 788SYL | Half Dummy | \$32.95 | \$32.95 | \$32.95 | \$32.95 | \$34.60 | | | | | | 12 |

NOTE: Can be ordered with (RDT) Round Rose or (SQT) Square Rose option. Example - 720SYL RDT 11P

Singapore

| | Model | Function | Finish | | | | | | | | Case Qty | | |
|--|------------|-------------|----------|----------|----------|-----|----------|----------|----------|----------|----------|----------|--------|
| | | | 11P | 15 | 26 | 26D | 514 | 11Px15 | 11Px26 | 15x26 | | 514x15 | 514x26 |
|  | 720SAL | Hall/Closet | \$65.90 | \$65.90 | \$65.90 | | \$69.20 | \$65.90 | \$65.90 | \$65.90 | \$69.20 | \$69.20 | 12 |
| | 730SAL | Bed/Bath | \$69.20 | \$69.20 | \$69.20 | | \$72.50 | \$69.20 | \$69.20 | \$69.20 | \$72.50 | \$72.50 | 12 |
| | 740SAL SMT | Entry | \$116.90 | \$116.90 | \$116.90 | | \$120.20 | \$116.90 | \$116.90 | \$116.90 | \$120.20 | \$120.20 | 12 |
| | 788SAL | Half Dummy | \$32.95 | \$32.95 | \$32.95 | | \$34.60 | | | | | | 20 |

NOTE: Square (SQT) or Round (RDT) rose options available

| Katella | Model | Function | Finish | | | | | | | | Case Qty | | | | |
|--|--------------|-----------------|---------------|-----------|-----------|------------|------------|---------------|---------------|--------------|-----------------|---------------|---------------|--|----|
| | | | 11P | 15 | 26 | 26D | 514 | 11Px15 | 11Px26 | 15x26 | | 514x15 | 514x26 | | |
|  | 720KAL | Hall/Closet | | \$65.90 | | | | \$69.20 | | | | | | | 12 |
| | 730KAL | Bed/Bath | | \$69.20 | | | | \$72.50 | | | | | | | 12 |
| | 740KAL SMT | Entry | | \$116.90 | | | | \$120.20 | | | | | | | 12 |
| | 788KAL | Half Dummy | | \$32.95 | | | | \$34.60 | | | | | | | 20 |

| Commonwealth® | Model | Function | Finish | | | | | | | | Case Qty | | | |
|---|--------------|-----------------|---------------|------------|----------|------------|-----------|------------|-----------|------------|-----------------|------------|--|----|
| | | | 3 | L03 | 5 | 11P | 15 | 15A | 26 | 26D | | 514 | | |
|  | 720CHL | Hall/Closet | \$60.40 | \$65.90 | \$65.90 | \$65.90 | \$65.90 | | | | \$65.90 | \$69.20 | | 12 |
| | 725CHL | Hall/Closet UL | \$66.40 | \$71.90 | \$71.90 | \$71.90 | \$71.90 | | | | \$71.90 | \$75.20 | | 12 |
| | 730CHL | Bed/Bath | \$63.70 | | \$69.20 | \$69.20 | \$69.20 | | | | \$69.20 | \$72.50 | | 12 |
| | 735CHL | Bed/Bath UL | \$69.70 | | \$75.20 | \$75.20 | \$75.20 | | | | \$75.20 | \$78.50 | | 12 |
| | 740CHL | Entry | \$111.40 | \$116.90 | \$116.90 | \$116.90 | \$116.90 | | | | \$116.90 | \$120.20 | | 12 |
| | 740CHL SMT | Entry | \$111.40 | \$116.90 | \$116.90 | \$116.90 | \$116.90 | | | | \$116.90 | \$120.20 | | 12 |
| | 745CHL | Entry UL | \$117.40 | \$122.90 | \$122.90 | \$122.90 | \$122.90 | | | | \$122.90 | \$126.20 | | 12 |
| | 745CHL SMT | Entry UL | \$117.40 | \$122.90 | \$122.90 | \$122.90 | \$122.90 | | | | \$122.90 | \$126.20 | | 12 |
| | 788CHL | Half Dummy | \$30.20 | | \$32.95 | \$32.95 | \$32.95 | | | | \$32.95 | \$34.60 | | 20 |

| Lido® | Model | Function | Finish | | | | | | | | Case Qty | | | |
|---|--------------|-------------------------|---------------|------------|----------|------------|-----------|------------|-----------|------------|-----------------|------------|--|----|
| | | | 3 | L03 | 5 | 11P | 15 | 15A | 26 | 26D | | 514 | | |
|  | 720LL | Hall/Closet | \$50.50 | | \$56.00 | \$56.00 | \$56.00 | \$56.00 | \$56.00 | | \$56.00 | | | 20 |
| | 725LL | Hall/Closet UL | \$56.50 | | \$62.00 | \$62.00 | \$62.00 | \$62.00 | \$62.00 | | \$62.00 | | | 20 |
| | 730LL | Bed/Bath | \$53.80 | | \$59.30 | \$59.30 | \$59.30 | \$59.30 | \$59.30 | | \$59.30 | | | 20 |
| | 735LL | Bed/Bath UL | \$59.80 | | \$65.30 | \$65.30 | \$65.30 | \$65.30 | \$65.30 | | \$65.30 | | | 20 |
| | 740LL SMT | Entry | \$78.40 | | \$83.90 | \$83.90 | \$83.90 | \$83.90 | \$83.90 | | \$83.90 | | | 20 |
| | 741LL SMT | Entry, Free Interior | \$83.40 | | \$88.90 | \$88.90 | \$88.90 | \$88.90 | \$88.90 | | \$88.90 | | | 20 |
| | 745LL SMT | Entry UL | \$84.40 | | \$89.90 | \$89.90 | \$89.90 | \$89.90 | \$89.90 | | \$89.90 | | | 20 |
| | 746LL SMT | Entry, Free Interior UL | \$89.40 | | \$94.90 | \$94.90 | \$94.90 | \$94.90 | \$94.90 | | \$94.90 | | | 20 |
| | 750LL SMT | Vestibule | \$83.40 | | \$88.90 | \$88.90 | \$88.90 | \$88.90 | \$88.90 | | \$88.90 | | | 20 |
| | 755LL SMT | Vestibule UL | \$89.40 | | \$94.90 | \$94.90 | \$94.90 | \$94.90 | \$94.90 | | \$94.90 | | | 20 |
| | 788LL | Half Dummy | \$25.25 | | \$28.00 | \$28.00 | \$28.00 | \$28.00 | \$28.00 | | \$28.00 | | | 20 |

| Tustin™ | Model | Function | Finish | | | | | | | | Case Qty | | | |
|---|--------------|-------------------------|---------------|------------|----------|------------|-----------|------------|-----------|------------|-----------------|------------|--|-----|
| | | | 3 | L03 | 5 | 11P | 15 | 15A | 26 | 26D | | 514 | | |
|  | 720TNL | Hall/Closet | \$50.50 | | \$56.00 | \$56.00 | \$56.00 | \$56.00 | \$56.00 | \$56.00 | \$56.00 | \$59.30 | | 12* |
| | 725TNL | Hall/Closet UL | \$56.50 | | \$62.00 | \$62.00 | \$62.00 | \$62.00 | \$62.00 | \$62.00 | \$62.00 | \$65.30 | | 12* |
| | 730TNL | Bed/Bath | \$53.80 | | \$59.30 | \$59.30 | \$59.30 | \$59.30 | \$59.30 | \$59.30 | \$59.30 | \$62.60 | | 12* |
| | 735TNL | Bed/Bath UL | \$59.80 | | \$65.30 | \$65.30 | \$65.30 | \$65.30 | \$65.30 | \$65.30 | \$65.30 | | | 12* |
| | 740TNL | Entry | | | \$83.90 | \$83.90 | \$83.90 | \$83.90 | \$83.90 | \$83.90 | \$83.90 | | | 12* |
| | 740TNL SMT | Entry | \$78.40 | | \$83.90 | \$83.90 | \$83.90 | \$83.90 | \$83.90 | \$83.90 | \$83.90 | \$87.20 | | 12* |
| | 740TNL SMC | Entry | | | | \$86.40 | \$86.40 | | | | | | | 12* |
| | 741TNL | Entry, Free Interior | \$83.40 | | \$88.90 | \$88.90 | \$88.90 | \$88.90 | \$88.90 | \$88.90 | \$88.90 | | | 12* |
| | 741TNL SMT | Entry, Free Interior | \$83.40 | | \$88.90 | \$88.90 | \$88.90 | \$88.90 | \$88.90 | \$88.90 | \$88.90 | | | 12* |
| | 745TNL | Entry UL | \$84.40 | | \$89.90 | \$89.90 | \$89.90 | \$89.90 | \$89.90 | \$89.90 | \$89.90 | | | 12* |
| | 745TNL SMT | Entry UL | \$84.40 | | \$89.90 | \$89.90 | \$89.90 | \$89.90 | \$89.90 | \$89.90 | \$89.90 | | | 12* |
| | 746TNL | Entry, Free Interior UL | \$89.40 | | \$94.90 | \$94.90 | \$94.90 | \$94.90 | \$94.90 | \$94.90 | \$94.90 | | | 12* |
| | 746TNL SMT | Entry, Free Interior UL | \$89.40 | | \$94.90 | \$94.90 | \$94.90 | \$94.90 | \$94.90 | \$94.90 | \$94.90 | | | 12* |
| | 750TNL | Vestibule | \$83.40 | | \$88.90 | \$88.90 | \$88.90 | \$88.90 | \$88.90 | \$88.90 | \$88.90 | | | 12* |
| | 750TNL SMT | Vestibule | \$83.40 | | \$88.90 | \$88.90 | \$88.90 | \$88.90 | \$88.90 | \$88.90 | \$88.90 | | | 12* |
| | 755TNL | Vestibule UL | \$89.40 | | \$94.90 | \$94.90 | \$94.90 | \$94.90 | \$94.90 | \$94.90 | \$94.90 | | | 12* |
| | 755TNL SMT | Vestibule UL | \$89.40 | | \$94.90 | \$94.90 | \$94.90 | \$94.90 | \$94.90 | \$94.90 | \$94.90 | | | 12* |
| | 788TNL | Half Dummy | \$25.25 | | \$28.00 | \$28.00 | \$28.00 | \$28.00 | \$28.00 | \$28.00 | \$28.00 | \$29.65 | | 20 |

|  Laurel® | Model | Function | Finish | | | | | | | | Case Qty | |
|---|----------|-------------|--------|-----|---|---------|---------|-----|---------|-----|----------|-----|
| | | | 3 | L03 | 5 | 11P | 15 | 15A | 26 | 26D | | 514 |
| | 720L | Hall/Closet | | | | \$54.60 | \$54.60 | | \$54.60 | | \$57.80 | 12 |
| | 730L | Bed/Bath | | | | \$57.90 | \$57.90 | | \$57.90 | | \$61.10 | 12 |
| | 740L SMT | Entry | | | | \$80.90 | \$80.90 | | \$80.90 | | \$84.10 | 12 |
| | 788L | Half Dummy | | | | \$27.30 | \$27.30 | | \$27.30 | | \$28.90 | 20 |

|  Pismo | Model | Function | Finish | | | | | | | | Case Qty | | |
|---|-------------|----------------|---------|---------|---------|---------|---------|---------|---------|---------|----------|---------|--------|
| | | | 11P | 15 | 26 | 26D | 514 | 11Px15 | 11Px26 | 15x26 | | 514x15 | 514x26 |
| | 720PSK | Hall/Closet | \$44.70 | \$44.70 | \$44.70 | \$44.70 | \$47.90 | \$44.70 | \$44.70 | \$44.70 | | \$47.90 | 12 |
| | 725PSK | Hall/Closet UL | \$50.70 | \$50.70 | \$50.70 | \$50.70 | \$53.90 | | | | | | 12 |
| | 730PSK | Bed/Bath | \$48.00 | \$48.00 | \$48.00 | \$48.00 | \$51.20 | \$48.00 | \$48.00 | \$48.00 | | \$51.20 | 12 |
| | 740PSK SMT | Entry | \$71.00 | \$71.00 | \$71.00 | \$71.00 | \$74.20 | \$71.00 | \$71.00 | \$71.00 | | \$74.20 | 12 |
| | 740PSK SMC* | Entry | | \$73.50 | \$73.50 | | \$76.70 | | | | | | 12 |
| | 788PSK | Half Dummy | \$22.35 | \$22.35 | \$22.35 | \$22.35 | \$23.95 | | | | | | 20 |

NOTE: Can be ordered with (RDT) Round Rose or (SQT) Square Rose option. Example - 720PSK RDT 514; *(SQT) Square Rose Only

|  Hancock® | Model | Function | Finish | | | | | | | | Case Qty | | |
|--|----------|-------------------------|---------|---------|---------|---------|---------|---------|---------|---------|----------|---------|----|
| | | | 3 | L03 | 5 | 11P | 15 | 15A | 26 | 26D | | 514 | |
| | 720H | Hall/Closet | \$33.60 | \$39.10 | \$39.10 | \$39.10 | \$39.10 | \$39.10 | \$39.10 | \$39.10 | \$39.10 | \$42.30 | 12 |
| | 725H | Hall/Closet UL | \$39.60 | \$45.10 | \$45.10 | \$45.10 | \$45.10 | \$45.10 | \$45.10 | \$45.10 | \$45.10 | \$48.30 | 12 |
| | 730H | Bed/Bath | \$36.90 | | \$42.40 | \$42.40 | \$42.40 | \$42.40 | \$42.40 | \$42.40 | \$42.40 | \$45.60 | 12 |
| | 735H | Bed/Bath UL | \$42.90 | | \$48.40 | \$48.40 | \$48.40 | \$48.40 | \$48.40 | \$48.40 | \$48.40 | \$51.60 | 12 |
| | 740H | Entry | \$59.90 | \$65.40 | \$65.40 | \$65.40 | \$65.40 | \$65.40 | \$65.40 | \$65.40 | \$65.40 | \$68.60 | 12 |
| | 740H SMT | Entry | \$59.90 | \$65.40 | \$65.40 | \$65.40 | \$65.40 | \$65.40 | \$65.40 | \$65.40 | \$65.40 | \$68.60 | 12 |
| | 740H SMC | Single Cylinder | | | | \$67.90 | \$67.90 | | | | | | 12 |
| | 741H | Entry, Free Interior | \$64.90 | \$70.40 | \$70.40 | \$70.40 | \$70.40 | \$70.40 | \$70.40 | \$70.40 | \$70.40 | \$73.60 | 12 |
| | 741H SMT | Entry, Free Interior | \$64.90 | \$70.40 | \$70.40 | \$70.40 | \$70.40 | \$70.40 | \$70.40 | \$70.40 | \$70.40 | \$73.60 | 12 |
| | 745H | Entry UL | \$65.90 | \$71.40 | \$71.40 | \$71.40 | \$71.40 | \$71.40 | \$71.40 | \$71.40 | \$71.40 | \$74.60 | 12 |
| | 745H SMT | Entry UL | \$65.90 | \$71.40 | \$71.40 | \$71.40 | \$71.40 | \$71.40 | \$71.40 | \$71.40 | \$71.40 | \$74.60 | 12 |
| | 746H | Entry, Free Interior UL | \$70.90 | \$76.40 | \$76.40 | \$76.40 | \$76.40 | \$76.40 | \$76.40 | \$76.40 | \$76.40 | | 12 |
| | 746H SMT | Entry, Free Interior UL | \$70.90 | \$76.40 | \$76.40 | \$76.40 | \$76.40 | \$76.40 | \$76.40 | \$76.40 | \$76.40 | | 12 |
| | 750H | Vestibule | \$64.90 | \$70.40 | \$70.40 | \$70.40 | \$70.40 | \$70.40 | \$70.40 | \$70.40 | \$70.40 | \$73.60 | 12 |
| | 750H SMT | Vestibule | \$64.90 | \$70.40 | \$70.40 | \$70.40 | \$70.40 | \$70.40 | \$70.40 | \$70.40 | \$70.40 | \$73.60 | 12 |
| | 755H | Vestibule UL | \$70.90 | \$76.40 | \$76.40 | \$76.40 | \$76.40 | \$76.40 | \$76.40 | \$76.40 | \$76.40 | \$79.60 | 12 |
| | 755H SMT | Vestibule UL | \$70.90 | \$76.40 | \$76.40 | \$76.40 | \$76.40 | \$76.40 | \$76.40 | \$76.40 | \$76.40 | \$79.60 | 12 |
| | 788H | Half Dummy | \$16.80 | \$19.55 | \$19.55 | \$19.55 | \$19.55 | \$19.55 | \$19.55 | \$19.55 | \$19.55 | \$21.15 | 20 |

|  Abbey® | Model | Function | Finish | | | | | | | | Case Qty | | |
|--|----------|-------------------------|---------|-----|---|-----|----|-----|----|-----|----------|-----|----|
| | | | 3 | L03 | 5 | 11P | 15 | 15A | 26 | 26D | | 514 | |
| | 720A | Hall/Closet | \$31.40 | | | | | | | | \$36.90 | | 12 |
| | 725A | Hall/Closet UL | \$37.40 | | | | | | | | \$42.90 | | 12 |
| | 730A | Bed/Bath | \$34.70 | | | | | | | | \$40.20 | | 12 |
| | 735A | Bed/Bath UL | \$40.70 | | | | | | | | \$46.20 | | 12 |
| | 740A | Entry | \$57.70 | | | | | | | | \$63.20 | | 12 |
| | 740A SMT | Entry | \$57.70 | | | | | | | | \$63.20 | | 12 |
| | 741A | Entry, Free Interior | \$62.70 | | | | | | | | \$68.20 | | 12 |
| | 741A SMT | Entry, Free Interior | \$62.70 | | | | | | | | \$68.20 | | 12 |
| | 745A | Entry UL | \$63.70 | | | | | | | | \$69.20 | | 12 |
| | 745A SMT | Entry UL | \$63.70 | | | | | | | | \$69.20 | | 12 |
| | 746A | Entry, Free Interior UL | \$68.70 | | | | | | | | \$74.20 | | 12 |
| | 746A SMT | Entry, Free Interior UL | \$68.70 | | | | | | | | \$74.20 | | 12 |
| | 750A | Vestibule | \$62.70 | | | | | | | | \$68.20 | | 12 |
| | 750A SMT | Vestibule | \$62.70 | | | | | | | | \$68.20 | | 12 |
| | 755A | Vestibule UL | \$68.70 | | | | | | | | \$74.20 | | 12 |
| | 755A SMT | Vestibule UL | \$68.70 | | | | | | | | \$74.20 | | 12 |
| | 788A | Half Dummy | \$15.70 | | | | | | | | \$18.45 | | 20 |

Cameron®



| Model | Function | Finish | | | | | | | | | | Case Qty |
|-----------|----------------------|---------|-----|---|---------|---------|-----|----|-----|-----|--|----------|
| | | 3 | L03 | 5 | 11P | 15 | 15A | 26 | 26D | 514 | | |
| 720CN | Hall/Closet | \$31.40 | | | \$36.90 | \$36.90 | | | | | | 30 |
| 730CN | Bed/Bath | \$34.70 | | | \$40.20 | \$40.20 | | | | | | 30 |
| 740CN | Entry | \$57.70 | | | \$63.20 | \$63.20 | | | | | | 30 |
| 740CN SMT | Entry | \$57.70 | | | \$63.20 | \$63.20 | | | | | | 30 |
| 741CN | Entry, Free Interior | \$62.70 | | | \$68.20 | \$68.20 | | | | | | 30 |
| 741CN SMT | Entry, Free Interior | \$62.70 | | | \$68.20 | \$68.20 | | | | | | 30 |
| 750CN | Vestibule | \$62.70 | | | \$68.20 | \$68.20 | | | | | | 30 |
| 750CN SMT | Vestibule | \$62.70 | | | \$68.20 | \$68.20 | | | | | | 30 |
| 788CN | Half Dummy | \$15.70 | | | \$18.45 | \$18.45 | | | | | | 20 |

980/985



| Model | Function | Finish | | | | | | | | | | Case Qty |
|---------|--------------------|--------|-----|----------|----------|----------|-----|----|-----|-----|----------|----------|
| | | 3 | L03 | 5 | 11P | 15 | 15A | 26 | 26D | 514 | | |
| 980 | Single Cylinder | | | \$81.40 | \$81.40 | \$81.40 | | | | | \$84.70 | 12 |
| 980 SMT | Single Cylinder | | | \$81.40 | \$81.40 | \$81.40 | | | | | \$84.70 | 12 |
| 982 | Single Cylinder UL | | | \$87.40 | \$87.40 | \$87.40 | | | | | \$90.70 | 12 |
| 982 SMT | Single Cylinder UL | | | \$87.40 | \$87.40 | \$87.40 | | | | | \$90.70 | 12 |
| 984 | Double Cylinder UL | | | \$116.40 | \$116.40 | \$116.40 | | | | | \$119.70 | 12 |
| 984 SMT | Double Cylinder UL | | | \$116.40 | \$116.40 | \$116.40 | | | | | \$119.70 | 12 |
| 985 | Double Cylinder | | | \$110.40 | \$110.40 | \$110.40 | | | | | \$113.70 | 12 |
| 985 SMT | Double Cylinder | | | \$110.40 | \$110.40 | \$110.40 | | | | | \$113.70 | 12 |

Uptown Deadbolt



| Model | Function | Function | | | | | | | | | | Case Qty |
|-------------|-----------------|----------|---------|---------|-----|---------|---------|---------|---------|---------|--|----------|
| | | 5 | 11P | 15 | 15A | 26 | 26D | 514 | 11Px15 | 11Px26 | | |
| 258 RDT SMT | Single Cylinder | | \$81.40 | \$81.40 | | \$81.40 | \$81.40 | \$84.70 | \$81.40 | \$81.40 | | 12 |

Downtown Deadbolt



| Model | Function | Function | | | | | | | | | | Case Qty |
|-------------|-----------------|----------|---------|---------|-----|---------|---------|---------|---------|---------|--|----------|
| | | 5 | 11P | 15 | 15A | 26 | 26D | 514 | 11Px15 | 11Px26 | | |
| 258 SQT SMT | Single Cylinder | | \$81.40 | \$81.40 | | \$81.40 | \$81.40 | \$84.70 | \$81.40 | \$81.40 | | 12 |
| 258 SQT SMC | Single Cylinder | | | \$83.90 | | \$83.90 | | \$87.20 | | | | 12 |

San Clemente Rectangular Deadbolt



| Model | Function | Function | | | | | | | | | | Case Qty |
|-------------|-----------------|----------|-----|---------|-----|---------|-----|---------|--------|--------|--|----------|
| | | 5 | 11P | 15 | 15A | 26 | 26D | 514 | 11Px15 | 11Px26 | | |
| 258 RCT SMT | Single Cylinder | | | \$89.40 | | \$89.40 | | \$92.70 | | | | 12 |

Austin Deadbolt



| Model | Function | Function | | | | | | | | | | Case Qty |
|------------|-----------------|----------|-----|---|----------|----------|-----|----|-----|-----|--|----------|
| | | 3 | L03 | 5 | 11P | 15 | 15A | 26 | 26D | 514 | | |
| 980AUD SMT | Single Cylinder | | | | \$81.40 | \$81.40 | | | | | | 12 |
| 985AUD SMT | Double Cylinder | | | | \$110.40 | \$110.40 | | | | | | 12 |

780/785



| Model | Function | Finish | | | | | | | | | Case |
|---------|--------------------|---------|----------|----------|----------|----------|----------|----------|----------|---------|------|
| | | 3 | L03 | 5 | 11P | 15 | 15A | 26 | 26D | 514 | Qty |
| 780 | Single Cylinder | \$60.30 | \$69.00 | \$69.00 | \$69.00 | \$69.00 | \$69.00 | \$69.00 | \$69.00 | \$72.30 | 12 |
| 780 SMT | Single Cylinder | \$60.30 | \$69.00 | \$69.00 | \$69.00 | \$69.00 | \$69.00 | \$69.00 | \$69.00 | \$72.30 | 12 |
| 780 SMC | Single Cylinder | | | | \$71.50 | \$71.50 | | | \$71.50 | | 12 |
| 782 | Single Cylinder UL | \$66.30 | \$75.00 | \$75.00 | \$75.00 | \$75.00 | \$75.00 | \$75.00 | \$75.00 | | 12 |
| 782 SMT | Single Cylinder UL | \$66.30 | \$75.00 | \$75.00 | \$75.00 | \$75.00 | \$75.00 | \$75.00 | \$75.00 | \$78.30 | 12 |
| 784 | Double Cylinder UL | \$95.30 | \$104.00 | \$104.00 | \$104.00 | \$104.00 | \$104.00 | \$104.00 | \$104.00 | | 12 |
| 784 SMT | Double Cylinder UL | \$95.30 | \$104.00 | \$104.00 | \$104.00 | \$104.00 | \$104.00 | \$104.00 | \$104.00 | | 12 |
| 785 | Double Cylinder | \$89.30 | \$98.00 | \$98.00 | \$98.00 | \$98.00 | \$98.00 | \$98.00 | \$98.00 | | 12 |
| 785 SMT | Double Cylinder | \$89.30 | \$98.00 | \$98.00 | \$98.00 | \$98.00 | \$98.00 | \$98.00 | \$98.00 | | 12 |

Halifax Deadbolt



| Model | Function | Function | | | | | | | | Case | |
|-------------|--------------------|----------|---------|---------|---------|----------|---------|---------|---------|---------|-----|
| | | 11P | 15 | 26 | 26D | 514 | 11Px15 | 11Px26 | 15x26 | 514x26 | Qty |
| 158 SQT | Single Cylinder | \$69.00 | \$69.00 | \$69.00 | \$69.00 | \$72.30 | | | | | 12 |
| 158 SQT SMT | Single Cylinder | \$69.00 | \$69.00 | \$69.00 | \$69.00 | \$72.30 | \$69.00 | \$69.00 | \$69.00 | \$72.30 | 12 |
| 158 SQT SMC | Single Cylinder | | \$71.50 | \$71.50 | | \$74.80 | | | | | 12 |
| 982 SQT | Single Cylinder UL | \$75.00 | \$75.00 | \$75.00 | \$75.00 | \$78.30 | | | | | 12 |
| 982 SQT SMT | Single Cylinder UL | \$75.00 | \$75.00 | \$75.00 | \$75.00 | \$78.30 | | | | | 12 |
| 159 SQT | Double Cylinder | \$98.00 | \$98.00 | \$98.00 | \$98.00 | \$101.30 | | | | | 12 |
| 159 SQT SMT | Double Cylinder | \$98.00 | \$98.00 | \$98.00 | \$98.00 | \$101.30 | | | | | 12 |

Milan Deadbolt



| Model | Function | Function | | | | | | | | Case | |
|-------------|--------------------|----------|---------|---------|---------|----------|---------|---------|---------|---------|-----|
| | | 11P | 15 | 26 | 26D | 514 | 11Px15 | 11Px26 | 15x26 | 514x26 | Qty |
| 158 RDT | Single Cylinder | \$69.00 | \$69.00 | \$69.00 | \$69.00 | \$72.30 | | | | | 12 |
| 158 RDT SMT | Single Cylinder | \$69.00 | \$69.00 | \$69.00 | \$69.00 | \$72.30 | \$69.00 | \$69.00 | \$69.00 | \$72.30 | 12 |
| 982 RDT | Single Cylinder UL | \$75.00 | \$75.00 | \$75.00 | \$75.00 | \$78.30 | | | | | 12 |
| 982 RDT SMT | Single Cylinder UL | \$75.00 | \$75.00 | \$75.00 | \$75.00 | \$78.30 | | | | | 12 |
| 159 RDT | Double Cylinder | \$98.00 | \$98.00 | \$98.00 | \$98.00 | \$101.30 | | | | | 12 |
| 159 RDT SMT | Double Cylinder | \$98.00 | \$98.00 | \$98.00 | \$98.00 | \$101.30 | | | | | 12 |

Gatelatch



| Model | Function | Finish | | | | | | | | | Case |
|---------|-----------------|----------|-----|----------|-----|----------|-----|----|----------|-----|------|
| | | 3 | L03 | 5 | 11P | 15 | 15A | 26 | 26D | 514 | Qty |
| 598 SMT | Single Cylinder | \$85.70 | | \$94.40 | | \$94.40 | | | \$94.40 | | 12 |
| 599 | Double Cylinder | | | | | \$123.40 | | | \$123.40 | | 12 |
| 599 SMT | Double Cylinder | \$114.70 | | \$123.40 | | \$123.40 | | | \$123.40 | | 12 |

KWIKSET SIGNATURE SERIES HANDLESETS

| | |
|--------------|---|
| Door Prep | Deadbolt: Cross Bore 2-1/8" or 1-1/2". Edge Bore 1". Handle: Cross Bore 2-1/8". Edge Bore 1". |
| Backset | Deadbolt: Adjustable to 2-3/8" or 2-3/4". Handle: Adjustable to 2-3/8" or 2-3/4". |
| Door | 1-3/4" doors standard. 2-1/4" doors optional. |
| Thickness | Not designed for use on 1-3/8" doors. |
| Cylinder | SmartKey Security or Pin & Tumbler |
| Faceplate | 1" x 2-1/4". Specify round corner, square corner or drive-in. |
| Strikes | Deadbolt: 1-1/4" x 3-5/8". Specify round corner or square corner. Others options available. Handle: 2-1/4" full lip. Specify round corner or square corner. Other options available. |
| Bolt | Deadbolt: 1" throw. Handle: 1/2" throw. |
| Door Handing | Reversible for right or left-hand doors. |
| ANSI/BHMA | Deadbolt is Grade 1 Certified. Montara Deadbolt is Grade 2 Certified. |
| ADA | N/A |
| UL | Optional 1/3 hour UL* fire rating for all functions except 802, 819 and 502 |

KWIKSET SIGNATURE SERIES LEVERS

| | |
|--------------|---|
| Door Prep | Cross Bore 2-1/8" Edge Bore 1" Latch Face 1" x 2-1/4" |
| Backset | Adjustable 2-3/8" or 2-3/4". |
| Door | 1-3/8" – 1-3/4" doors standard. |
| Thickness | 2-1/4" doors optional on 720 and 740 models. Up to 2-1/8" doors optional on HFL/MIL/LSL/MRL/SYL/SAL |
| Cylinder | SmartKey Security or Pin & Tumbler. |
| Rose | Specify round or square rose - HFL, LSL, MRL, SYL, MIL, SAL |
| Faceplate | 1" x 2-1/4". Specify round corner, square corner or drive-in. |
| Strikes | 2-1/4" full lip. Specify round corner or square corner. Other options available. |
| Bolt | 1/2" throw |
| Door Handing | Specify handing only with inactive levers |
| ANSI/BHMA | Grade 2 Certified. |
| ADA | Families of MRL, SYL, LSL, MIL, HFL in Functions Passage, Privacy are in compliance with the American National Standards Institute (ANSI A117.1) and the Americans with Disabilities Act (ADA). |
| UL | Meets UL 3 hour fire rating for 725, 735, 745, 746, 749, 755 Optional UL* 1/3 hour fire rating for all functions |

KWIKSET SIGNATURE SERIES KNOBS

| | |
|--------------|--|
| Door Prep | Cross Bore: 2-1/8" Edge Bore: 1" Latch Face: 1" x 2-1/4". |
| Backset | Adjustable to 2-3/8" or 2-3/4". UL 2-3/4" standard 2-3/8" optional. |
| Door | 1-3/8" – 1-3/4" doors standard. |
| Thickness | 2-1/4" doors optional on 720 and 740 models only. |
| Cylinder | SmartKey Security or Pin & Tumbler. |
| Faceplate | 1" x 2-1/4". Specify round corner, square corner or drive-in. |
| Strikes | 2-1/4" full lip. Specify round corner or square corner. Other options available. |
| Bolt | 1/2" throw. |
| Door Handing | Reversible for right- or left-hand doors. |
| ANSI/BHMA | Grade 2 Certified |
| ADA | N/A |
| UL | Meets UL 3 hour fire rating for 725, 735, 745, 746, 749 and 755. Optional UL* 1/3 hour fire rating for all functions |

VANCOUVER HANDLESET

| | |
|-----------------------------|--|
| Door Prep (Deadbolt/Handle) | Crossbore 2-1/8". Edge Bore 1". Latch Face 1" x 2-1/4" Deadbolt & Handle bore holes must be 5-1/2" apart |
| Backset (Deadbolt/Handle) | Adjustable 2-3/8" or 2-3/4" |
| Door | 1-3/4" Standard. |
| Thickness | Thick door service part available for up to 2-1/4" |
| Cylinder | SmartKey Security |
| Faceplate | 1" x 2-1/4". Square, round, or drive in |
| Strikes | Deadbolt: 1-1/8" x 2-3/4" round; 2-1/4" full lip round (non-graded) Handle: 2-1/4" full lip round |
| Bolt | Deadbolt: 1" Throw Handle: 1/2" Throw |
| Door Handing | Reversible for right or left-hand doors. |
| ANSI/BHMA | Deadbolt – A156.39 Grade AAA Certified |
| ADA | N/A |
| UL | N/A |
| Warranty | Lifetime Mechanical and Lifetime Finish. |

*Optional UL 1/3 hour list price charge is \$2.50.

**KWIKSET SIGNATURE SERIES
158/159 CONTEMPORARY DEADBOLTS**

| | |
|----------------|--|
| Door Prep | Cross Bore 2-1/8" or 1-1/2". Edge Bore 1". |
| Backset | Adjustable 2-3/8" or 2-3/4". |
| Door Thickness | SMT 1-3/8" – 1-3/4". |
| Cylinder | SmartKey Security or Pin & Tumbler (158 and 159) |
| Rose | Specify round or square rose |
| Strikes | 1-1/4" x 3-5/8" Square or Round Corner. |
| Bolt | 1" Throw Steel. |
| ANSI/BHMA | A156.36 Grade 2 |
| ADA | Interior turn pieces are in compliance with the American National Standards Institute (ANSI A117.1) and the Americans with Disabilities Act (ADA). |
| UL | Optional UL* 1/3 hour fire rating for all functions. |

**KWIKSET SIGNATURE SERIES
780-785 DEADBOLTS**

| | |
|----------------|--|
| Door Prep | 780, 785: Crossbore 2-1/8" or 1-1/2". Edge Bore 1". 782, 784: Crossbore 2-1/8". Edge Bore 1". |
| Backset | Adjustable 2-3/8" or 2-3/4" standard. |
| Door Thickness | 1-3/8" – 1-3/4" doors standard. 1-7/8" – 2-1/4" optional. |
| Cylinder | SmartKey Security or 6-pin removable core. |
| Faceplate | 1" x 2-1/4". Specify round corner, square corner or drive-in. |
| Strikes | 1-1/4" x 3-5/8". Specify round corner or square corner. Other options available. |
| Bolt | 1" throw. |
| Door Handing | Reversible for right or left-hand doors. |
| ANSI/BHMA | Grade 2 Certified. |
| ADA | Interior turn pieces are in compliance with the American National Standards Institute (ANSI A117.1) and the Americans with Disabilities Act (ADA). |
| UL | Meets UL 3 hour fire rating for 782 & 784 Optional UL* 1/3 hour fire rating for all functions |

**KWIKSET SIGNATURE SERIES
980/985 DEADBOLTS**

| | |
|----------------|--|
| Door Prep | 980, 985: Crossbore 2-1/8" or 1-1/2". Edge Bore 1". 982, 984: Crossbore 2-1/8". Edge Bore 1". |
| Backset | Adjustable 2-3/8" or 2-3/4". |
| Door Thickness | 1-3/8" – 1-3/4" doors standard. 1-7/8" – 2-1/4" optional. |
| Cylinder | SmartKey Security or Pin & Tumbler. |
| Faceplate | 1" x 2-1/4". Specify round corner, square corner or drive-in. |
| Strikes | Grade 2 - 3222/3223 strike (1-1/4" x 3-5/8"). Grade 1 - 20049/20050 strike (1-1/8" x 2-3/4") |
| Bolt | 1" throw. |
| Door Handing | Reversible for right or left-hand doors. |
| ANSI/BHMA | Grade 1 Certified. |
| ADA | Interior turn pieces are in compliance with the American National Standards Institute (ANSI A117.1) and the Americans with Disabilities Act (ADA). |
| UL | Meets UL 3 hour fire rating for 982 and 984 Optional UL* 1/3 hour fire rating for all functions |

*Optional UL 1/3 hour list price charge is \$2.50.

**KWIKSET SIGNATURE SERIES 258
UPTOWN & DOWNTOWN CONTEMPORARY
DEADBOLTS , AND SAN CLEMENTE**

| | |
|----------------|--|
| Door Prep | Cross Bore 2-1/8". Edge Bore 1". |
| Backset | Adjustable 2-3/8" or 2-3/4". |
| Door Thickness | 1-3/8" – 1-3/4" Standard. Thick door service part available for up to 2'1/4". |
| Cylinder | Smartkey Security |
| Faceplate | 1" x 2-1/4" Square, round, or drive in. |
| Rose | Specify round (Uptown) or square (Downtown) rose. |
| Strikes | 1" x 2-1/4" square or round corner. |
| Bolt | 1" Throw Steel. |
| ANSI/BHMA | A156.36 Grade 1 |
| ADA | Interior turn pieces are in compliance with the American National Standards Institute (ANSI A117.1) and the Americans with Disabilities Act (ADA). |
| UL | Optional UL* 1/3 hour fire rating for all functions. |

KWIKSET SIGNATURE SERIES HANDLESET

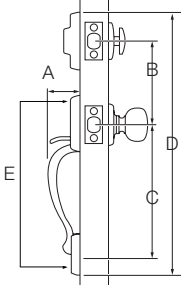

| Design | A | B | C | D | E |
|--------------|----------|--------|----------|-----------|-----------|
| Arlington® | 2-1/2" | 5-1/2" | 11" | 19-1/16" | 15 |
| Ashfield™ | 2-31/32" | 5-1/2" | 8-13/32" | 17-3/4" | 14-11/25" |
| Austin | 3-1/8" | 5-1/2" | 8-13/32" | 18-13/32" | 13-17/20" |
| | | | 9-1/8" | | |
| | | | 9-11/16" | | |
| Avalon™ | 2-7/8" | 5-1/2" | 8-13/32" | 18-5/32" | 12-13/20" |
| Chelsea® | 2-3/16" | 5-1/2" | 9-11/16" | 18-1/2" | 13 |
| Hawthorne™ | 2-7/8" | 5-1/2" | 8-13/32" | 17-7/16" | 13-2/5" |
| Montara™ | 2-5/8" | 5-1/2" | 8-13/32" | 17-5/8" | 12-1/5" |
| | | | 9-1/8" | | |
| | | | 9-11/16" | | |
| Prague | 2-25/32" | 5-1/2" | 8-13/32" | 17-23/32" | |
| | | | 9-11/16" | | |
| Prescott | 2-25/32" | 5-1/2" | 8-13/32" | 17-23/32" | |
| | | | 9-11/16" | | |
| San Clemente | 2-5/8" | 5-1/2" | 8-13/32" | 17-15/16" | |
| | | | 9-11/16" | | |
| Shelburne™ | 2-7/8" | 5-1/2" | 8-13/32" | 18-1/4" | 12-3/5" |
| Tavaris | 2-17/32" | 5-1/2" | 8-13/32" | 18" | 12-19/25" |
| Vancouver | 2-1/32" | 5-1/2" | 8-13/32" | 17-15/16" | |
| | | | 9-11/16" | | |

KWIKSET SIGNATURE SERIES KNOBS

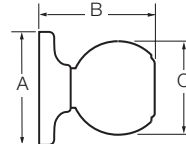

| Design | A | B | C |
|----------|--------|----------|---------|
| Abbey® | 2-5/8" | 2-17/16" | 2" |
| Cameron® | 2-5/8" | 2-13/32" | 2-1/8" |
| Hancock® | 2-5/8" | 2-1/2" | 2-3/8" |
| Laurel® | 2-5/8" | 2-7/16" | 2-7/16" |
| Pismo | 2-5/8" | 2-13/32" | 2-6/7" |

KWIKSET SIGNATURE SERIES LEVERS

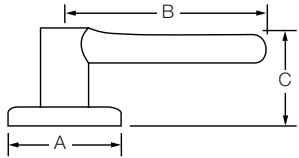

| Design | A | B | C | C (Keyed) |
|------------------|----------|----------|----------|-----------|
| Ashfield™ | 2-5/8" | 4-3/16" | 2-9/16" | 2-9/16" |
| Austin | 2-13/16" | 4-1/8" | 2-2/3" | 2-3/4" |
| Commonwealth® | 2-5/8" | 4-7/32" | 2-7/16" | 2-7/16" |
| Halifax | 2-5/8" | 4-15/32" | 2-19/32" | 2-3/8" |
| Katella | 2-21/32" | 4-1/4" | 2-15/32" | 2-9/816" |
| Lido® | 2-5/8" | 3-3/4" | 1-29/32" | 2-15/32" |
| Lisbon | 2-5/8" | 4-5/32" | 2-9/16" | 2-3/8" |
| Milan | 2-5/8" | 4-5/32" | 2-9/16" | 2-3/8" |
| Montreal | 2-5/8" | 4-1/4" | 2-5/8" | 2-11/16" |
| Pembroke™ | 2-5/8" | 4-7/32" | 2-23/32" | 2-23/32" |
| Singapore Round | 2-11/16" | 4-7/32" | 2-1/2" | 2-1/4" |
| Singapore Square | 2-11/16" | 4-7/32" | 2-1/2" | 2-1/4" |
| Sydney® | 2-5/8" | 4-1/4" | 2-3/4" | 2-3/8" |
| Tustin® | 2-5/8" | 4-7/32" | 2-3/32" | 2-19/32" |

KWIKSET SIGNATURE SERIES 158-159 DEADBOLT

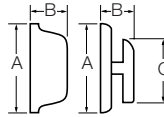

| Round Design | A | B | C |
|--------------|----------|----------|----------|
| 158 Interior | 2-17/32" | 1-13/32" | 1-11/16" |
| 158 Exterior | 2-17/32" | 15/16" | |
| 159 Interior | 2-17/32" | 1-13/32" | 1-11/16" |
| 159 Exterior | 2-17/32" | 15/16" | |

| Square Design | A | B | C |
|---------------|----------|----------|----------|
| 158 Interior | 2-17/32" | 1-13/32" | 1-11/16" |
| 158 Exterior | 2-19/32" | 15/16" | |
| 159 Interior | 2-17/32" | 1-13/32" | 1-11/16" |
| 159 Exterior | 2-19/32" | 15/16" | |

KWIKSET SIGNATURE SERIES 980-985 DEADBOLT

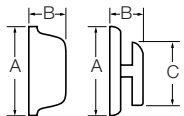

| Design | A | B | C |
|--------------|----------|---------|----------|
| 980 Interior | 2-19/32" | 1-5/32" | 1-13/16" |
| 980 Exterior | 2-5/8" | 1-1/32" | |
| 985 Interior | 2-5/8" | 1-1/32" | |
| 985 Exterior | 2-5/8" | 1-1/32" | |

KWIKSET SIGNATURE SERIES AUSTIN 980-985 DEADBOLT

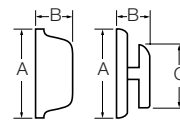

| Design | A | B | C |
|--------------|----------|---------|---------|
| 980 Interior | 3-13/32" | 1-1/2" | 1-7/16" |
| 980 Exterior | 3-17/32" | 1-1/16" | |
| 985 Interior | 3-17/32" | 1-1/16" | |
| 985 Exterior | 3-17/32" | 1-1/16" | |

KWIKSET SIGNATURE SERIES 780-785 DEADBOLT

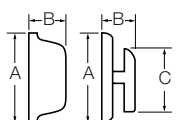

| Design | A | B | C |
|-------------------|--------|--------|----------|
| 780, 782 Interior | 2-1/2" | 15/16" | 1-25/32" |
| 780, 782 Exterior | 2-5/8" | 1-1/8" | |
| 784, 785 Interior | 2-5/8" | 1-1/8" | |
| 784, 785 Exterior | 2-5/8" | 1-1/8" | |

KWIKSET SIGNATURE SERIES 258 UPTOWN & DOWNTOWN DEADBOLT

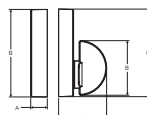

| Design | A | B | C |
|--------------------|--------|----------|--------|
| 258 Round Interior | 1-3/8" | 1-21/32" | 2-5/8" |
| 258 Round Exterior | 9/16" | 2-5/8" | |

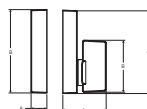

| Design | A | B | C |
|---------------------|---------|----------|--------|
| 258 Square Interior | 1-7/16" | 1-21/32" | 2-5/8" |
| 258 Square Exterior | 1/2" | 2-5/8" | |

Trusted Security



- ANSI/BHMA Grade 3
- Easy Installation
- Available with SmartKey® Security
- Most Recognized Styles

Warranty

- Lifetime Mechanical
- Lifetime Finish



Amador



Bellevue™



Dakota™



| Amador | Model | Function | Finish | | | | | | | | Case | | |
|--------|------------|-----------------|--------|-----|---|----------|----------|-----|----|----------|----------|----------|---|
| | | | 3 | L03 | 5 | 11P | 15 | 15A | 26 | 26D | 514 | Qty | |
| | 687AMD SMT | Single Cylinder | | | | \$175.70 | \$175.70 | | | \$175.70 | \$158.30 | \$184.30 | 6 |
| | 687AMD SMC | Single Cylinder | | | | | \$178.20 | | | \$178.20 | | \$186.80 | 6 |
| | 689AMD SMT | Double Cylinder | | | | \$180.70 | \$180.70 | | | \$180.70 | \$163.30 | | 6 |
| | 699AMD | Dummy | | | | \$159.70 | \$159.70 | | | \$159.70 | \$142.30 | | 6 |
| | 898AMD | Handle Only | | | | \$137.70 | \$137.70 | | | \$137.70 | | \$146.30 | 6 |

| Bellevue™ | Model | Function | Finish | | | | | | | | Case | | |
|-----------|-----------|-----------------|----------|-----|----------|----------|----------|-----|----|-----|----------|----------|---|
| | | | 3 | L03 | 5 | 11P | 15 | 15A | 26 | 26D | 514 | Qty | |
| | 687BW | Single Cylinder | \$118.00 | | \$118.00 | \$135.40 | \$135.40 | | | | \$118.00 | | 6 |
| | 687BW SMT | Single Cylinder | \$123.00 | | \$123.00 | \$140.40 | \$140.40 | | | | \$123.00 | \$149.00 | 6 |
| | 689BW | Double Cylinder | \$123.00 | | \$123.00 | \$140.40 | \$140.40 | | | | \$123.00 | | 6 |
| | 689BW SMT | Double Cylinder | \$128.00 | | \$128.00 | \$145.40 | \$145.40 | | | | \$128.00 | | 6 |
| | 699BW | Dummy | \$107.00 | | \$107.00 | \$124.40 | \$124.40 | | | | \$107.00 | \$133.00 | 6 |
| | 898BW | Handle Only | | | | \$102.42 | \$102.42 | | | | | | 6 |

| Dakota™ | Model | Function | Finish | | | | | | | | Case | | |
|---------|-----------|------------------------|----------|-----|----------|----------|----------|----------|----|-----|----------|-----|---|
| | | | 3 | L03 | 5 | 11P | 15 | 15A | 26 | 26D | 514 | Qty | |
| | 687DA | Single Cylinder | \$118.00 | | \$118.00 | \$135.40 | \$135.40 | \$135.40 | | | \$118.00 | | 6 |
| | 687DA SMT | Single Cylinder | \$123.00 | | \$123.00 | \$140.40 | \$140.40 | \$140.40 | | | \$123.00 | | 6 |
| | 687DA SMC | Single Cylinder | \$125.50 | | | \$142.90 | \$142.90 | | | | | | 6 |
| | 689DA | Double Cylinder | \$123.00 | | \$123.00 | \$140.40 | \$140.40 | \$140.40 | | | \$123.00 | | 6 |
| | 689DA SMT | Double Cylinder | \$128.00 | | \$128.00 | \$145.40 | \$145.40 | \$145.40 | | | \$128.00 | | 6 |
| | 699DA | Dummy | \$107.00 | | \$107.00 | \$124.40 | \$124.40 | \$124.40 | | | \$107.00 | | 6 |
| | 899DA | Handleset† with Balboa | | | | \$158.90 | \$158.90 | | | | | | 6 |
| | 898DA | Handle Only | | | | \$102.40 | \$102.40 | | | | | | 6 |

†Denotes handleset without deadbolt

INTERIOR PACK FUNCTION OPTIONS

| Model | Function | Series | | | |
|---------|-----------------|---------------------------|----------------|---------------|--------------|
| | | Signataure Lever & Laurel | Signature Knob | Kwikset Lever | Kwikset Knob |
| 604 | Single Cylinder | \$66.20 | \$54.10 | \$60.70 | \$49.70 |
| 605 | Double Cylinder | \$86.60 | \$74.50 | \$73.20 | \$62.20 |
| 605 SMT | Double Cylinder | \$91.60 | \$79.50 | \$78.20 | \$67.20 |
| 606 | Dummy | \$57.00 | \$44.90 | \$50.20 | \$39.20 |

NOTE: 604 and 606 interior packs not impacted by SmartKey Security.

| Kwikset Handleset & Interior Pack Finish Options | | 3 | L03 | 5 | 11P | 15 | 15A | 26 | 26D | 514 | Qty |
|--|---------------|---|-----|---|-----|----|-----|----|-----|-----|-----|
| Kwikset <i>Signature Series</i> | Abbey Knob | • | | | | | | • | | | 4 |
| | Halifax Lever | | | | ° | ° | | ° | | ° | 4 |
| | Hancock Knob | • | | • | • | • | • | • | • | | 4 |
| | Laurel Knob | | | | • | • | | • | | | 4 |
| | Lido Lever | • | | • | | • | • | | • | | 4 |
| | Tustin Lever | • | | • | • | • | • | • | • | | 4 |
| Kwikset | Aliso Knob | • | | | • | • | | • | | | 4 |
| | Balboa Lever | • | | • | • | • | | • | • | • | 4 |
| | Breton Lever | | | | | • | | • | | • | 4 |
| | Casey Lever | | | | | • | | • | | • | 4 |
| | Cove Knob | | | | • | • | | • | • | • | 4 |
| | Delta Lever | • | | • | • | • | • | • | • | | 4 |
| | Dorian Lever | • | | • | • | • | • | • | • | | 4 |
| | Ladera Lever | | | | • | • | | • | • | • | 4 |
| | Polo Knob | • | | • | • | • | • | • | • | | 4 |
| | Tylo Knob | • | | • | | • | | • | • | | 4 |

° Item only available in 604 Function with Square Rose and Square Interior Thumbturn

Balboa™

| Model | Function | Finish | | | | | | | | | Case Qty |
|-----------|-------------|---------|-----|---------|---------|---------|-----|---------|---------|---------|----------|
| | | 3 | L03 | 5 | 11P | 15 | 15A | 26 | 26D | 514 | |
| 200BL | Hall/Closet | \$41.20 | | \$41.20 | \$45.30 | \$45.30 | | \$45.30 | \$41.20 | \$48.30 | 12* |
| 300BL | Bed/Bath | \$44.20 | | \$44.20 | \$48.30 | \$48.30 | | \$48.30 | \$44.20 | \$51.30 | 12* |
| 405BL | Keyed Lever | \$59.70 | | \$59.70 | \$63.80 | \$63.80 | | \$63.80 | \$59.70 | | 12* |
| 405BL SMT | Keyed Lever | \$64.70 | | \$64.70 | \$68.80 | \$68.80 | | \$68.80 | \$64.70 | \$71.80 | 12* |
| 405BL SMC | Keyed Lever | | | | \$71.30 | \$71.30 | | | | | 12* |
| 488BL | Half Dummy | \$20.60 | | \$20.60 | \$22.65 | \$22.65 | | \$22.65 | \$20.60 | \$24.15 | 20 |

Delta®

| Model | Function | Finish | | | | | | | | | Case Qty |
|-----------|-------------------------------|---------|-----|---------|---------|---------|---------|---------|---------|---------|----------|
| | | 3 | L03 | 5 | 11P | 15 | 15A | 26 | 26D | 514 | |
| 200DL | Hall/Closet | \$41.20 | | \$41.20 | \$45.30 | \$45.30 | \$45.30 | \$45.30 | \$41.20 | | 12* |
| 300DL | Bed/Bath | \$44.20 | | \$44.20 | \$48.30 | \$48.30 | \$48.30 | \$48.30 | \$44.20 | | 12* |
| 405DL | Keyed Lever | \$59.70 | | \$59.70 | \$63.80 | \$63.80 | \$63.80 | \$63.80 | \$59.70 | | 12* |
| 405DL SMT | Keyed Lever | \$64.70 | | \$64.70 | \$68.80 | \$68.80 | \$68.80 | \$68.80 | \$64.70 | | 12* |
| 405DL SMC | Keyed Lever | | | | | \$71.30 | | | | \$67.20 | 12* |
| 406DL | Free Interior, Keyed Lever | \$62.70 | | \$62.70 | | | \$66.80 | \$66.80 | \$62.70 | | 12* |
| 406DL SMT | Free Interior, Keyed Lever | \$67.70 | | \$67.70 | | | \$71.80 | \$71.80 | \$67.70 | | 12* |
| 409DL | Keyed Lever UL | \$65.70 | | \$65.70 | \$69.80 | \$69.80 | \$69.80 | \$69.80 | \$65.70 | | 12* |
| 409DL SMT | Keyed Lever UL | \$70.70 | | \$70.70 | \$74.80 | \$74.80 | \$74.80 | \$74.80 | \$70.70 | | 12* |
| 412DL | Vestibule Keyed Lever UL | \$68.70 | | \$68.70 | | | \$72.80 | \$72.80 | \$68.70 | | 12* |
| 412DL SMT | Vestibule Keyed Lever UL | \$73.70 | | \$73.70 | | | \$77.80 | \$77.80 | \$73.70 | | 12* |
| 413DL | Free Interior, Keyed Lever UL | \$68.70 | | \$68.70 | | | \$72.80 | \$72.80 | \$68.70 | | 12* |
| 413DL SMT | Free Interior, Keyed Lever UL | \$73.70 | | \$73.70 | | | \$77.80 | \$77.80 | \$73.70 | | 12* |
| 420DL | Hall/Closet UL | \$47.20 | | \$47.20 | \$51.30 | \$51.30 | \$51.30 | \$51.30 | \$47.20 | | 12* |
| 430DL | Bed/Bath UL | \$50.20 | | \$50.20 | | | \$54.30 | \$54.30 | \$50.20 | | 12* |
| 462DL | Vestibule Keyed Lever | \$62.70 | | \$62.70 | | | \$66.80 | \$66.80 | \$62.70 | | 12* |
| 462DL SMT | Vestibule Keyed Lever | \$67.70 | | \$67.70 | | | \$71.80 | \$71.80 | \$67.70 | | 12* |
| 488DL | Half Dummy | \$20.60 | | \$20.60 | \$22.65 | \$22.65 | \$22.65 | \$22.65 | \$20.60 | | 20 |

Dorian®

| Model | Function | Finish | | | | | | | | | Case Qty |
|------------|-------------------------------|---------|-----|---------|---------|---------|---------|---------|---------|-----|----------|
| | | 3 | L03 | 5 | 11P | 15 | 15A | 26 | 26D | 514 | |
| 200DNL | Hall/Closet | \$41.20 | | \$41.20 | \$45.30 | \$45.30 | \$45.30 | \$45.30 | \$41.20 | | 12* |
| 300DNL | Bed/Bath | \$44.20 | | \$44.20 | \$48.30 | \$48.30 | \$48.30 | \$48.30 | \$44.20 | | 12* |
| 405DNL | Keyed Lever | \$59.70 | | \$59.70 | \$63.80 | \$63.80 | \$63.80 | \$63.80 | \$59.70 | | 12* |
| 405DNL SMT | Keyed Lever | \$64.70 | | \$64.70 | \$68.80 | \$68.80 | \$68.80 | \$68.80 | \$64.70 | | 12* |
| 405DNL SMC | Keyed Lever | \$67.20 | | | \$71.30 | \$71.30 | | | | | 12* |
| 406DNL | Free Interior, Keyed Lever | \$62.70 | | \$62.70 | | | \$66.80 | \$66.80 | \$62.70 | | 12* |
| 406DNL SMT | Free Interior, Keyed Lever | \$67.70 | | \$67.70 | | | \$71.80 | \$71.80 | \$67.70 | | 12* |
| 409DNL | Keyed Lever UL | \$65.70 | | \$65.70 | \$69.80 | \$69.80 | \$69.80 | \$69.80 | \$65.70 | | 12* |
| 409DNL SMT | Keyed Lever UL | \$70.70 | | \$70.70 | \$74.80 | \$74.80 | \$74.80 | \$74.80 | \$70.70 | | 12* |
| 412DNL | Vestibule Keyed Lever UL | \$68.70 | | \$68.70 | | | \$72.80 | \$72.80 | \$68.70 | | 12* |
| 412DNL SMT | Vestibule Keyed Lever UL | \$73.70 | | \$73.70 | | | \$77.80 | \$77.80 | \$73.70 | | 12* |
| 413DNL | Free Interior, Keyed Lever UL | \$68.70 | | \$68.70 | | | \$72.80 | \$72.80 | \$68.70 | | 12* |
| 413DNL SMT | Free Interior, Keyed Lever UL | \$73.70 | | \$73.70 | | | \$77.80 | \$77.80 | \$73.70 | | 12* |
| 420DNL | Hall/Closet UL | \$47.20 | | \$47.20 | \$51.30 | \$51.30 | \$51.30 | \$51.30 | \$47.20 | | 12* |
| 430DNL | Bed/Bath UL | \$50.20 | | \$50.20 | | | \$54.30 | \$54.30 | \$50.20 | | 12* |
| 462DNL | Vestibule Keyed Lever | \$62.70 | | \$62.70 | | | \$66.80 | \$66.80 | \$62.70 | | 12* |
| 462DNL SMT | Vestibule Keyed Lever | \$67.70 | | \$67.70 | | | \$71.80 | \$71.80 | \$67.70 | | 12* |
| 488DNL | Half Dummy | \$20.60 | | \$20.60 | \$22.65 | \$22.65 | \$22.65 | \$22.65 | \$20.60 | | 20 |

Ladera® SQT

| Model | Function | Finish | | | | | | | | | Case Qty |
|----------------|-------------|--------|-----|---|---------|---------|-----|---------|---------|---------|----------|
| | | 3 | L03 | 5 | 11P | 15 | 15A | 26 | 26D | 514 | |
| 200LRL SQT | Hall/Closet | | | | \$45.30 | \$45.30 | | \$45.30 | \$41.20 | \$48.30 | 12 |
| 300LRL SQT | Bed/Bath | | | | \$48.30 | \$48.30 | | \$48.30 | \$44.20 | \$51.30 | 12 |
| 405LRL SQT SMT | Keyed Lever | | | | \$68.80 | \$68.80 | | \$68.80 | \$64.70 | \$71.80 | 12 |
| 405LRL SQT SMC | Keyed Lever | | | | | \$71.30 | | \$71.30 | | \$74.30 | 12 |
| 488LRL SQT | Half Dummy | | | | \$22.65 | \$22.65 | | \$22.65 | \$20.60 | \$24.15 | 12 |

|  | Ladera® RDT | | Finish | | | | | | | | Case | |
|--|-------------|-------------|--------|-----|---|---------|---------|---------|---------|---------|---------|---------|
| | Model | Function | 3 | L03 | 5 | 11P | 15 | 15A | 26 | 26D | 514 | Qty |
| | 200LRL RDT | Hall/Closet | | | | | \$45.30 | \$45.30 | | \$45.30 | \$41.20 | \$48.30 |
| 300LRL RDT | Bed/Bath | | | | | \$48.30 | \$48.30 | | \$48.30 | \$44.20 | \$51.30 | 12* |
| 405LRL RDT | Keyed Lever | | | | | \$63.80 | \$63.80 | | \$63.80 | \$59.70 | | 12* |
| 405LRL RDT SMT | Keyed Lever | | | | | \$68.80 | \$68.80 | | \$68.80 | \$64.70 | \$71.80 | 12* |
| 488LRL RDT | Half Dummy | | | | | \$22.65 | \$22.65 | | \$22.65 | \$20.60 | \$24.15 | 20 |

|  | Casey RDT | | Finish | | | | | | | | Case | |
|---|-------------|-------------|--------|-----|---|---------|---------|-----|---------|---------|---------|---------|
| | Model | Function | 3 | L03 | 5 | 11P | 15 | 15A | 26 | 26D | 514 | Qty |
| | 200CSL RDT | Hall/Closet | | | | | \$49.70 | | | \$49.70 | | \$52.70 |
| 300CSL RDT | Bed/Bath | | | | | \$52.70 | | | \$52.70 | | \$55.70 | 12* |
| 405CSL RDT SMT | Keyed Lever | | | | | \$73.20 | | | \$73.20 | | \$76.20 | 12* |
| 488CSL RDT | Half Dummy | | | | | \$24.85 | | | \$24.85 | | \$26.35 | 20 |

|  | Casey SQT | | Finish | | | | | | | | Case | |
|---|-------------|-------------|--------|-----|---|---------|---------|-----|---------|---------|---------|---------|
| | Model | Function | 3 | L03 | 5 | 11P | 15 | 15A | 26 | 26D | 514 | Qty |
| | 200CSL SQT | Hall/Closet | | | | | \$49.70 | | | \$49.70 | | \$52.70 |
| 300CSL SQT | Bed/Bath | | | | | \$52.70 | | | \$52.70 | | \$55.70 | 12 |
| 405CSL SQT SMT | Keyed Lever | | | | | \$73.20 | | | \$73.20 | | \$76.20 | 12 |
| 488CSL SQT | Half Dummy | | | | | \$24.85 | | | \$24.85 | | \$26.35 | 12 |

|  | Breton RDT | | Finish | | | | | | | | Case | |
|---|-------------|-------------|--------|-----|---|---------|---------|-----|---------|---------|---------|---------|
| | Model | Function | 3 | L03 | 5 | 11P | 15 | 15A | 26 | 26D | 514 | Qty |
| | 200BRNL RDT | Hall/Closet | | | | | \$49.70 | | | \$49.70 | | \$52.70 |
| 300BRNL RDT | Bed/Bath | | | | | \$52.70 | | | \$52.70 | | \$55.70 | 12* |
| 405BRNL RDT SMT | Keyed Lever | | | | | \$73.20 | | | \$73.20 | | \$76.20 | 12* |
| 488BRNL RDT | Half Dummy | | | | | \$24.85 | | | \$24.85 | | \$26.35 | 20 |

|  | Breton SQT | | Finish | | | | | | | | Case | |
|---|-------------|-------------|--------|-----|---|---------|---------|-----|---------|---------|---------|---------|
| | Model | Function | 3 | L03 | 5 | 11P | 15 | 15A | 26 | 26D | 514 | Qty |
| | 200BRNL SQT | Hall/Closet | | | | | \$49.70 | | | \$49.70 | | \$52.70 |
| 300BRNL SQT | Bed/Bath | | | | | \$52.70 | | | \$52.70 | | \$55.70 | 12 |
| 405BRNL SQT SMT | Keyed Lever | | | | | \$73.20 | | | \$73.20 | | \$76.20 | 12 |
| 488BRNL SQT | Half Dummy | | | | | \$24.85 | | | \$24.85 | | \$26.35 | 12 |

|  | Aliso™ | | Finish | | | | | | | | Case | |
|---|------------|-------------|---------|-----|---|---------|---------|---------|---------|---------|------|-----|
| | Model | Function | 3 | L03 | 5 | 11P | 15 | 15A | 26 | 26D | 514 | Qty |
| | 200AO | Hall/Closet | \$27.80 | | | | \$30.80 | \$30.80 | | \$30.80 | | |
| 300AO | Bed/Bath | \$31.00 | | | | \$34.00 | \$34.00 | | \$34.00 | | | 30 |
| 400AO SMT | Entry | \$37.30 | | | | \$40.30 | \$40.30 | | \$40.30 | | | 30 |
| 488AO | Half Dummy | \$13.90 | | | | \$15.40 | \$15.40 | | \$15.40 | | | 20 |

|  | Cove™ | | Finish | | | | | | | | Case | |
|---|------------|-------------|--------|-----|---|---------|---------|---------|---------|---------|---------|---------|
| | Model | Function | 3 | L03 | 5 | 11P | 15 | 15A | 26 | 26D | 514 | Qty |
| | 200CV | Hall/Closet | | | | | \$30.80 | \$30.80 | | \$30.80 | \$27.80 | \$33.80 |
| 300CV | Bed/Bath | | | | | \$34.00 | \$34.00 | | \$34.00 | \$31.00 | \$37.00 | 30 |
| 400CV | Entry | | | | | \$40.30 | \$40.30 | | \$40.30 | \$37.30 | | 30 |
| 400CV SMT | Entry | | | | | \$45.30 | \$45.30 | | \$45.30 | \$42.30 | \$48.30 | 30 |
| 488CV | Half Dummy | | | | | \$15.40 | \$15.40 | | \$15.40 | \$13.90 | \$16.90 | 20 |

|  | Polo® | | Finish | | | | | | | | Case | |
|---|-----------------------|-------------|---------|-----|---------|---------|---------|---------|---------|---------|---------|-----|
| | Model | Function | 3 | L03 | 5 | 11P | 15 | 15A | 26 | 26D | 514 | Qty |
| | 200P | Hall/Closet | \$24.50 | | | \$24.50 | \$27.50 | \$27.50 | \$27.50 | \$27.50 | \$24.50 | |
| 300P | Bed/Bath | \$27.70 | | | \$27.70 | \$30.70 | \$30.70 | \$30.70 | \$30.70 | \$27.70 | | 30 |
| 400P | Entry | \$34.00 | | | \$34.00 | \$37.00 | \$37.00 | \$37.00 | \$37.00 | \$34.00 | | 30 |
| 400P SMT | Entry | \$39.00 | | | \$39.00 | \$42.00 | \$42.00 | \$42.00 | \$42.00 | \$39.00 | | 30 |
| 400P SMC | Entry | \$41.50 | | | | \$44.50 | \$44.50 | | | | | 30 |
| 401P | Entry (Free Interior) | \$37.00 | | | \$37.00 | \$40.00 | \$40.00 | | | \$37.00 | | 30 |
| 401P SMT | Entry (Free Interior) | \$42.00 | | | \$42.00 | \$45.00 | \$45.00 | | | \$42.00 | | 30 |
| 450P | Vestible | \$37.00 | | | \$37.00 | | | | | \$37.00 | | 30 |
| 450P SMT | Vestible | \$42.00 | | | \$42.00 | | | | | \$42.00 | | 30 |
| 488P | Half Dummy | \$12.25 | | | \$12.25 | \$13.75 | \$13.75 | \$13.75 | \$13.75 | \$12.25 | | 20 |

Tylo®

| Model | Function | Finish | | | | | | | | | Case Qty | |
|---|----------|-----------------------|---------|---|---------|----|---------|----|---------|---------|----------|----|
| | | 3 | L03 | 5 | 11P | 15 | 15A | 26 | 26D | 514 | | |
|  | 200T | Hall/Closet | \$22.30 | | \$22.30 | | \$25.30 | | \$25.30 | \$22.30 | | 30 |
| | 300T | Bed/Bath | \$25.50 | | \$25.50 | | \$28.50 | | \$28.50 | \$25.50 | | 30 |
| | 400T | Entry | \$31.80 | | \$31.80 | | \$34.80 | | \$34.80 | \$31.80 | | 30 |
| | 400T SMT | Entry | \$36.80 | | \$36.80 | | \$39.80 | | \$39.80 | \$36.80 | | 30 |
| | 401T | Entry (Free Interior) | \$34.80 | | \$34.80 | | \$37.80 | | | \$34.80 | | 30 |
| | 401T SMT | Entry (Free Interior) | \$39.80 | | \$39.80 | | \$42.80 | | | \$39.80 | | 30 |
| | 488T | Half Dummy | \$11.15 | | \$11.15 | | \$12.65 | | \$12.65 | \$11.15 | | 20 |

660/663/665

RDT

| Model | Function | Finish | | | | | | | | | Case Qty | |
|--|----------|---------------------|-----|---|-----|---------|---------|----|---------|---------|----------|----|
| | | 3 | L03 | 5 | 11P | 15 | 15A | 26 | 26D | 514 | | |
|  | 660 RDT | Single Cylinder SMT | | | | \$46.80 | \$46.80 | | \$46.80 | \$43.80 | \$49.80 | 12 |
| | 665 RDT | Double Cylinder SMT | | | | \$56.00 | \$56.00 | | \$56.00 | \$53.00 | \$59.00 | 12 |
| | 663 RDT | Single Sided | | | | \$26.20 | \$26.20 | | \$26.20 | \$24.50 | \$27.90 | 12 |

660/663 SQT

| Model | Function | Finish | | | | | | | | | Case Qty |
|---|-------------|---------------------|---|-----|---------|---------|----|---------|---------|---------|----------|
| | | 3 | 5 | 11P | 15 | 15A | 26 | 26D | 514 | | |
|  | 660 SQT | Single Cylinder SMT | | | \$46.80 | \$46.80 | | \$46.80 | \$43.80 | \$49.80 | 12 |
| | 660 SQT SMC | Single Cylinder | | | | \$49.30 | | \$49.30 | | \$52.30 | 12 |
| | 663 SQT | Single Sided | | | \$26.20 | \$26.20 | | \$26.20 | \$24.50 | \$27.90 | 12 |

660/665

| Model | Function | Finish | | | | | | | | | Case Qty | |
|--|----------|---------------------|---------|---|---------|---------|---------|---------|---------|---------|----------|----|
| | | 3 | L03 | 5 | 11P | 15 | 15A | 26 | 26D | 514 | | |
|  | 660 | Single Cylinder | \$32.10 | | \$32.10 | \$35.10 | \$35.10 | \$35.10 | \$35.10 | \$32.10 | \$36.70 | 12 |
| | 660 SMT | Single Cylinder SMT | \$37.10 | | \$37.10 | \$40.10 | \$40.10 | \$40.10 | \$40.10 | \$37.10 | \$43.10 | 12 |
| | 660 SMC | Single Cylinder | \$39.60 | | | \$42.60 | \$42.60 | | | \$39.60 | | 12 |
| | 665 | Double Cylinder | \$41.30 | | \$41.30 | \$44.30 | \$44.30 | \$44.30 | \$44.30 | \$41.30 | \$45.80 | 12 |
| | 665 SMT | Double Cylinder SMT | \$46.30 | | \$46.30 | \$49.30 | \$49.30 | \$49.30 | \$49.30 | \$46.30 | \$52.30 | 12 |

One-Sided

| Model | Function | Finish | | | | | | | | | Case Qty | |
|--|----------|---|---------|---|---------|---------|---------|---------|---------|---------|----------|----|
| | | 3 | L03 | 5 | 11P | 15 | 15A | 26 | 26D | 514 | | |
|  | 663 | Thumbturn One Side | \$18.00 | | \$18.00 | \$19.70 | \$19.70 | \$19.70 | \$19.70 | \$18.00 | \$21.30 | 12 |
| | 663 UL | Thumbturn One Side UL | \$24.00 | | \$24.00 | \$25.70 | \$25.70 | \$25.70 | \$25.70 | \$24.00 | \$27.30 | 12 |
| | 667 | Thumbturn One Side with Exterior Plate | \$32.10 | | \$32.10 | \$35.10 | \$35.10 | \$35.10 | \$35.10 | \$32.10 | | 12 |
| | 664 | Retrofit Kit for 663 | \$12.80 | | \$12.80 | \$14.00 | \$14.00 | | | \$12.80 | | 12 |
| | 677 | Thumbturn One Side with Exterior Plate UL | \$38.10 | | \$38.10 | \$41.10 | \$41.10 | | | \$38.10 | | 12 |

Deadbolt and Knob Combo Packs

| Model | Function | Finish | | | | | | | | | Case Qty | |
|---|----------|---|---------|---|---------|----|---------|----|-----|---------|----------|---|
| | | 3 | L03 | 5 | 11P | 15 | 15A | 26 | 26D | 514 | | |
|  | 690T | Keyed Entry Tylo Knob with Single Cylinder Deadbolt | \$57.50 | | \$57.50 | | \$62.90 | | | \$57.50 | | 6 |
| | 690T SMT | Keyed Entry Tylo Knob with Single Cylinder Deadbolt | \$66.50 | | \$66.50 | | \$71.90 | | | \$66.50 | | 6 |
| | 690P | Keyed Entry Polo Knob with Single Cylinder Deadbolt | \$59.50 | | | | \$64.90 | | | | | 6 |

KWIKSET HANDLESETS

| | |
|----------------|--|
| Door Prep | Deadbolt: Crossbore 2-1/8" or 1-1/2". Edge Bore 1". Handle: Crossbore 2-1/8". Edge Bore 1". |
| Backset | Deadbolt: Adjustable to 2-3/8" or 2-3/4". Handle: Adjustable to 2-3/8" or 2-3/4". |
| Door Thickness | 1-3/4" doors standard. 2-1/4" doors optional. Not designed for use on 1-3/8" doors. |
| Cylinder | SmartKey Security or traditional 5-Pin, Pin & Tumbler. |
| Faceplate | 1" x 2-1/4". Specify round corner, square corner or drive-in. |
| Strikes | Deadbolt: 1" x 2-1/4". Specify round corner or square corner. Other options available. Handle: 2-1/4" full lip. Specify round corner or square corner. Other options available. |
| Bolt | Deadbolt: 1" throw. Handle: 1/2" throw. |
| Door Handing | Reversible for right or left-hand doors. |
| ANSI/BHMA | Deadbolt is Grade 3 Certified. |
| ADA | N/A |
| UL | Optional UL 1/3 hour fire rating for all functions except 699* |

KWIKSET LEVERS

| | |
|----------------|---|
| Door Prep | Cross Bore 2-1/8". Edge Bore 1". |
| Backset | Adjustable to 2-3/8" or 2-3/4". UL 2-3/4" standard 2-3/8" optional. |
| Door Thickness | 1-3/8" – 1-3/4" doors standard. 2-1/4" doors optional on 200 and 400 functions only. |
| Cylinder | SmartKey Security or Pin & Tumbler. |
| Faceplate | 1" x 2-1/4". Specify round corner, square corner or dr |
| Strikes | 1" x 2-1/4" full lip. Specify round corner or square corner. Other options available. |
| Bolt | 1/2" throw. |
| Door Handing | Specify handing for dummy and interior pack levers. |
| ANSI/BHMA | Grade 3 Certified. (all functions except 488) |
| ADA | Functions 200 and 420 in compliance with the American National Standards Institute (ANSI A117.1) and the Americans with Disabilities Act (ADA). |
| UL | Meets UL 3 hour fire rating for 409, 412, 413, 420, 430 Optional UL 1/3 hour fire rating for all functions* |

KWIKSET DEADBOLTS

| | |
|----------------|--|
| Door Prep | 660, 665: Crossbore 2-1/8". Edge Bore 1". 663: Crossbore 1-5/8". Edge Bore 1". 667: Crossbore 2-1/8" or 1-1/2". Edge Bore 1". |
| Backset | 660, 665, 667: Adjustable latch standard. 663: 2-3/8" standard. 2-3/4" optional. |
| Door Thickness | 660, 663, 665, 667: 1-3/8" – 1-3/4" doors standard. |
| Cylinder | 660, 665: SmartKey Security or Pin & Tumbler. |
| Faceplate | 1" x 2-1/4". Specify round corner, square corner or drive-in. |
| Strikes | 1" x 2-1/4". Specify round corner or square corner. Other options available. |
| Bolt | 1" throw. |
| Door Handing | Reversible for right or left-hand doors. |
| ANSI/BHMA | Grade 3 Certified. |
| ADA | Interior turn pieces are in compliance with the American National Standards Institute (ANSI A117.1) and the Americans with Disabilities Act (ADA). |
| UL | Meets UL 3 hour fire rating for 677 and 663 Optional UL 1/3 hour fire rating for all functions* |

KWIKSET KNOBS

| | |
|----------------|---|
| Door Prep | Cross Bore 2-1/8". Edge Bore 1". |
| Backset | Adjustable to 2-3/8" or 2-3/4". 5" available as service part |
| Door Thickness | 1-3/8" – 1-3/4" doors standard. 2-1/4" doors optional on 200 and 400 models only. |
| Cylinder | SmartKey Security or Pin & Tumbler. |
| Faceplate | 1" x 2-1/4". Specify round corner, square corner or drive-in. Also available as drive-in latch. |
| Strikes | 2-1/4" full lip. Specify round corner or square corner. Other options available. |
| Bolt | 1/2" throw. |
| Door Handing | Reversible for right or left hand doors. |
| ANSI/BHMA | Grade 3 Certified. (all functions except 488) |
| ADA | N/A |
| UL | Optional UL 1/3 hour fire rating for all functions* |

*Optional UL 1/3 hour list price charge is \$2.50.

KWIKSET HANDLESET

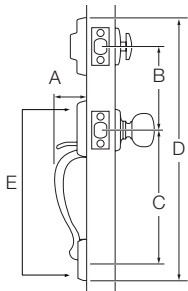

| Design | A | B | C | D | E |
|------------|---------|--------|----------|-----------|-----------|
| Amador | 2-5/32" | 5-1/2" | 9-11/16" | 17-15/32" | 12-14/28" |
| Belleview™ | 2-5/32" | 5-1/2" | 8-13/32" | 18-1/16" | 12-1/10" |
| Dakota™ | 2-5/32" | 5-1/2" | 8-13/32" | 17-3/16" | 12-1/10" |

KWIKSET KNOB

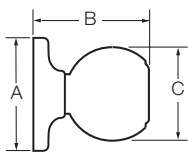

| Design | A | B | C |
|--------|--------|----------|---------|
| Aliso™ | 2-5/8" | 2-3/4" | 2-2/5" |
| Cove™ | 2-5/8" | 2-1/2" | 2-3/16" |
| Polo® | 2-5/8" | 2-23/32" | 1-7/8" |
| Tylo® | 2-5/8" | 2-1/2" | 1-7/8" |

KWIKSET LEVER

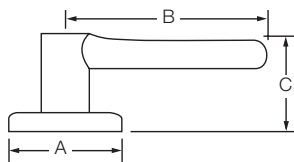

| Design | A | B | C | C (Keyed) |
|---------|--------|---------|----------|-----------|
| Balboa™ | 2-5/8" | 4-7/32" | 1-15/16" | 2-13/32" |
| Breton | 2-5/8" | 4" | 2-7/16" | 2-15/32" |
| Casey | 2-5/8" | 4-1/10" | 2-3/5" | 2-7/16" |
| Delta® | 2-5/8" | 3-5/8" | 1-7/8" | 2-15/32" |
| Dorian® | 2-5/8" | 3-3/4" | 2-1/8" | 2-11/16" |
| Ladera® | 2-5/8" | 4-3/16" | 1-7/8" | 2-7/16" |

KWIKSET DEADBOLT

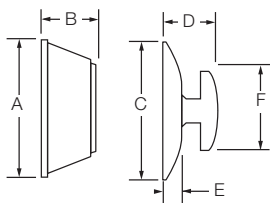

| Design | A | B | C | D | E | F |
|--------|----------|---------|---------|---------|--------|--------|
| 660 | 2-7/16" | 1-1/16" | 2-1/2" | 2-7/32" | 5/16" | 1-3/4" |
| 660RDT | 2-7/16" | 1-1/16" | 2-1/2" | 3-1/32" | 1-3/4" | |
| 660SQT | 2-7/16" | 1-1/16" | 2-1/2" | 3-1/32" | 1-3/4" | |
| 663 | | | 2-1/2" | 2-7/32" | 5/16" | 1-3/4" |
| 663RDT | | | 2-1/2" | 3-1/32" | 1-3/4" | |
| 663SQT | 2-7/16" | 1-1/16" | 2-1/2" | 3-1/32" | 1-3/4" | |
| 665 | 2-7/16" | 1-1/16" | 2-1/2" | 1-1/16" | | |
| 665RDT | 2-7/16" | 1-1/16" | 2-7/16" | 1-1/16" | | |
| 667 | 2-17/32" | 3/8" | 2-1/2" | 2-7/32" | 5/16" | 1-3/4" |
| 677 | 2-17/32" | 3/8" | 2-1/2" | 2-7/32" | 5/16" | 1-3/4" |

SMART LOCKS AND KEYLESS ENTRY LOCKS

Kwikset's electronic door locks offer users the convenience of keyless entry, virtually eliminating the need for keys. All of our electronic locks are easy to install and program while complementing any Kwikset knob, lever or handleset.



Features



- Smart Locks Replace any Deadbolt for Keyless Entry Convenience
- SmartCode™ Lever Ideal for - Small/Home Office, Utility/Storage Room, Interior Garage/Side Door
- Lock Your Door with the Touch of a Button
- Customizable Access Codes for Increased Security
- Back-Lit Keypad for Increased Visibility
- Customizable Automatic Door Locking After 30 Seconds for Peace Of Mind
- Installs In Minutes with Just a Screwdriver - No Hard Wiring Required
- Fits Standard Doors (1 3/8" - 2") with No Screw Holes Required

Warranty

- 1 Year Electronic Warranty
- Lifetime Finish & Mechanical Warranty

Kwikset



HALOTM



TOUCH

FINGERPRINT SMART LOCK

The Halo Touch Wi-Fi enabled smart lock with fingerprint access technology allows you to simply use your unique fingerprint to lock and unlock your door.



Wi-Fi Enabled



Works with the Kwikset App



HALOTM

WI-FI ENABLED SMART LOCKS

Halo smart locks connect directly to your existing home Wi-Fi network and smartphone to create a simple and secure smart home, without a third-party hub, panel or subscription service.

| Halo Wi-Fi Enabled Smart Locks Model | Function | Finish | | | | Case |
|--------------------------------------|-----------------------|----------|----------|----------|----------|------|
| | | 11P | 15 | 26 | 514 | Qty |
| 939 Halo Touchscreen | WiFi Enabled Deadbolt | \$504.00 | \$504.00 | \$504.00 | \$504.00 | 1 |
| 938 Halo Touchpad | WiFi Enabled Deadbolt | \$438.00 | \$438.00 | | | 1 |
| 959 Halo Touch Traditional | WiFi Enabled Deadbolt | \$517.00 | \$517.00 | | | 1 |
| 959 Halo Touch Contemporary | WiFi Enabled Deadbolt | | \$517.00 | | \$517.00 | 1 |

How it Works

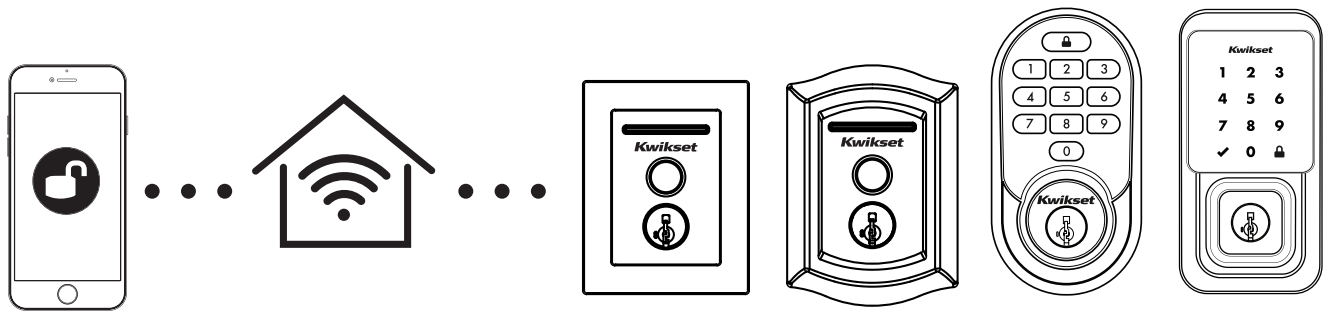

Control your lock from your smartphone

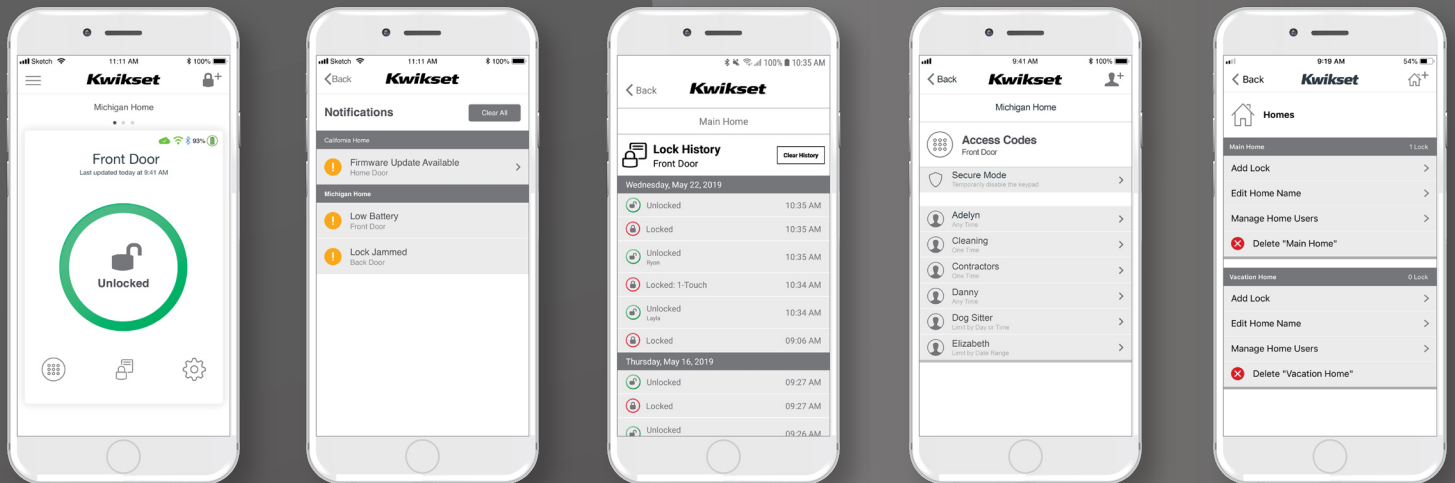

REMOTE ACCESS



PUSH NOTIFICATIONS



EVENT HISTORY



MANAGE ACCESS CODES



MANAGE MULTIPLE HOMES



| Premis™ | Model | Description | Finish | | | | | | | | Case Qty | | | |
|-------------------|---|-------------|--------|-----|---|----------|----------|-----|----|-----|----------|----------|--|---|
| | | | 3 | L03 | 5 | 11P | 15 | 15A | 26 | 26D | | 514 | | |
| 919 TRL PREMIS | Touchscreen Electronic Deadbolt with Apple HomeKit™ | | | | | \$484.00 | \$484.00 | | | | | | | 2 |
| 919 CNT PREMIS | Touchscreen Electronic Deadbolt with Home Kit | | | | | \$484.00 | | | | | | \$484.00 | | 2 |

| Obsidian™ | Model | Description | Finish | | | | | | | | Case Qty | | | |
|-----------|---------------------------------|-------------|--------|-----|---|----------|----------|-----|----|-----|----------|-----|--|---|
| | | | 3 | L03 | 5 | 11P | 15 | 15A | 26 | 26D | | 514 | | |
| 953 OBN | Touchscreen Electronic Deadbolt | | | | | \$407.00 | \$407.00 | | | | | | | 2 |

| SmartCode™ 915 TRL | Model | Description | Finish | | | | | | | | Case Qty | | | |
|-----------------------|---------------------------------|-------------|--------|-----|---|----------|----------|-----|----|-----|----------|-----|--|---|
| | | | 3 | L03 | 5 | 11P | 15 | 15A | 26 | 26D | | 514 | | |
| 915 TRL | Touchscreen Electronic Deadbolt | | | | | \$370.00 | \$370.00 | | | | | | | 2 |

| Aura™ | Model | Description | Finish | | | | | | | | Case Qty | | | |
|---------|---------------------------------|-------------|--------|-----|---|----------|----------|-----|----|-----|----------|----------|--|---|
| | | | 3 | L03 | 5 | 11P | 15 | 15A | 26 | 26D | | 514 | | |
| 942 BLE | Touchscreen Electronic Deadbolt | | | | | \$328.00 | \$328.00 | | | | | \$328.00 | | 1 |

| SmartCode™ 913 CNT | Model | Description | Finish | | | | | | | | Case Qty | | | |
|-----------------------|------------------------------|-------------|--------|-----|---|----------|----------|-----|----------|-----|----------|----------|--|---|
| | | | 3 | L03 | 5 | 11P | 15 | 15A | 26 | 26D | | 514 | | |
| 913 CNT | Touchpad Electronic Deadbolt | | | | | \$275.00 | \$275.00 | | \$275.00 | | | \$275.00 | | 2 |



**SmartCode™
913 TRL**



**SmartCode™
909 TRL**



**SmartCode™
917 TNL**



**SmartCode™
917 HFL**



Powerbolt 2®



**Kwikset
905**

**SmartCode™
913 TRL**

| Model | Description | Finish | | | | | | | | | | Case |
|-------------|------------------------------|--------|----------|---|----------|----------|-----|----|-----|-----|-----|------|
| | | 3 | L03 | 5 | 11P | 15 | 15A | 26 | 26D | 514 | Qty | |
| 913 TRL SMT | Touchpad Electronic Deadbolt | | \$275.00 | | \$275.00 | \$275.00 | | | | | | 2 |

**SmartCode™
909 TRL**

| Model | Description | Finish | | | | | | | | | | Case |
|---------|------------------------------|--------|----------|---|----------|----------|-----|----|-----|-----|-----|------|
| | | 3 | L03 | 5 | 11P | 15 | 15A | 26 | 26D | 514 | Qty | |
| 909 SMT | Touchpad Electronic Deadbolt | | \$231.00 | | \$231.00 | \$231.00 | | | | | | 2 |

**SmartCode™
917 TNL**

| Model | Description | Finish | | | | | | | | | | Case |
|---------|----------------------------------|--------|-----|---|----------|----------|-----|----|-----|-----|-----|------|
| | | 3 | L03 | 5 | 11P | 15 | 15A | 26 | 26D | 514 | Qty | |
| 917 TNL | Touchpad Electronic Lever Tustin | | | | \$262.00 | \$262.00 | | | | | | 2 |

**SmartCode™
917 HFL**

| Model | Description | Finish | | | | | | | | | | Case |
|---------|-----------------------------------|--------|-----|---|-----|----------|-----|----------|-----|----------|-----|------|
| | | 3 | L03 | 5 | 11P | 15 | 15A | 26 | 26D | 514 | Qty | |
| 917 HFL | Touchpad Electronic Lever Halifax | | | | | \$262.00 | | \$262.00 | | \$262.00 | | 2 |

Powerbolt 2®

| Model | Description | Finish | | | | | | | | | | Case |
|---------|------------------------------|--------|----------|---|----------|----------|-----|----|-----|-----|-----|------|
| | | 3 | L03 | 5 | 11P | 15 | 15A | 26 | 26D | 514 | Qty | |
| 907 SMT | Touchpad Electronic Deadbolt | | \$157.00 | | \$157.00 | \$157.00 | | | | | | 2 |

905 Keyless Entry

| Model | Description | Finish | | | | | | | | | | Case |
|-------|------------------------------|--------|-----|---|----------|----------|-----|----|-----|-----|-----|------|
| | | 3 | L03 | 5 | 11P | 15 | 15A | 26 | 26D | 514 | Qty | |
| 905 | Touchpad Electronic Deadbolt | | | | \$110.00 | \$110.00 | | | | | | 2 |

 **HOME
CONNECT™**
ELECTRONIC SMART LOCKS

Control your lock from anywhere on your smart phone, tablet, or internet connected device and never worry about forgetting to lock your door again.

- Remotely lock and unlock your door from anywhere
- Receive notifications of your lock's activity
- Control when others have access to your home
- Arm or disarm your security panel
- Wirelessly communicate to other devices in your home



Features

- Full 128-Bit Encryption Security
- Motorized locking mechanism enables true remote locking & unlocking
- SmartKey Security - providing superior security against advanced break-in techniques.
- Easy Integration
- Z-Wave Wireless Protocol
- Fits Standard Doors (1 3/8"-2") with No Screw Holes Required
- 4 AA Alkaline Batteries (no hard wiring) - batteries last for approximately 1 year

Electronic Locks with Home Connect (Z-Wave)

| Item Number | Function | Finish | | | | | | Case Qty. | Price |
|------------------------------------|---------------------------------------|--------|-----|----|----|-----|-----|-----------|----------|
| | | L03 | 11P | 15 | 26 | 26D | 514 | | |
| HomeConnect 620 Traditional | | L03 | 11P | 15 | 26 | 26D | 514 | | |
| 98930-001 | HC620 TRL ZW700 15 SMT RCALFD RCS BP | | | • | | | | 1 | \$297.00 |
| 98930-002 | HC620 TRL ZW700 11P SMT RCALFD RCS BP | | • | | | | | 1 | \$297.00 |
| 98930-003 | HC620 TRL ZW700 L03 SMT RCALFD RCS BP | • | | | | | | 1 | \$297.00 |

*Product must be ordered by item number and not description

| HomeConnect 620 Contemporary | | L03 | 11P | 15 | 26 | 26D | 514 | | |
|-------------------------------------|---------------------------------------|-----|-----|----|----|-----|-----|---|----------|
| 98930-004 | HC620 CNT ZW700 15 SMT RCALFD RCS BP | | | • | | | | 1 | \$297.00 |
| 98930-005 | HC620 CNT ZW700 11P SMT RCALFD RCS BP | | • | | | | | 1 | \$297.00 |
| 98930-006 | HC620 CNT ZW700 26 SMT RCALFD RCS BP | | | | • | | | 1 | \$297.00 |
| 98930-007 | HC620 CNT ZW700 514 SMT RCALFD RCS BP | | | | | | • | 1 | \$297.00 |

*Product must be ordered by item number and not description

| Obsidian™ with Home Connect | | L03 | 11P | 15 | 26 | 26D | 514 | | |
|------------------------------------|--------------------------|-----|-----|----|----|-----|-----|---|----------|
| 99540-001 | 954 OBN ZW500 15 RCALFD | | | • | | | | 1 | \$506.00 |
| 99540-002 | 954 OBN ZW500 11P RCALFD | | • | | | | | 1 | \$506.00 |

*Product must be ordered by item number and not description

| SmartCode™ 916 Contemporary with Home Connect | | L03 | 11P | 15 | 26 | 26D | 514 | | |
|--|------------------------------------|-----|-----|----|----|-----|-----|---|----------|
| 99160-016 | 916CNT TSCR ZW500 15 SMTCD | | | • | | | | 1 | \$506.00 |
| 99160-017 | 916CNT TSCR 11P ZW500 SMTCD | | • | | | | | 1 | \$506.00 |
| 99160-018 | 916CNT TSCR 26 ZW500 SMTCD | | | | • | | | 1 | \$506.00 |
| 99160-028 | 916CNT ZW500 514 SMT CP TPR RCALFD | | | | | | • | 1 | \$506.00 |

*Product must be ordered by item number and not description

| SmartCode™ 916 with Home Connect | | L03 | 11P | 15 | 26 | 26D | 514 | | |
|---|-------------------------|-----|-----|----|----|-----|-----|---|----------|
| 99160-019 | 916TRL ZW500 L03 RCALFD | • | | | | | | 1 | \$506.00 |
| 99160-020 | 916TRL ZW500 15 RCALFD | | | • | | | | 1 | \$506.00 |
| 99160-021 | 916TRL ZW500 11P RCALFD | | • | | | | | 1 | \$506.00 |

*Product must be ordered by item number and not description

| SmartCode™ 912 with Home Connect | | L03 | 11P | 15 | 26 | 26D | 514 | | |
|---|-------------------------|-----|-----|----|----|-----|-----|---|----------|
| 99120-037 | 912TNL ZW500 15 RCALFD | | | • | | | | 1 | \$413.00 |
| 99120-038 | 912TNL ZW500 11P RCALFD | | • | | | | | 1 | \$413.00 |

*Product must be ordered by item number and not description



Halo™, Halo™ Touch

| | |
|----------------|--|
| Function | Single cylinder deadbolt |
| Door Prep | 2 1/8" diameter bore hole & 1" diameter latch hole |
| Backset | Adjustable 2 3/8" or 2 3/4" |
| Door Thickness | 1 3/8" - 2" automatic adjustment |
| Faceplates | 1" x 2 1/4" round corner standard |
| Strikes | Round corner, 4 hole strike, 2 3/4" x 1 1/8" |
| Latch | Round corner adjustable 2 3/8" x 2 3/4" |
| Bolt | 1" throw, steel deadbolt |
| Door Handing | Reversible |
| Cylinder | SmartKey Security™ |

SMARTCODE™ 916

| | |
|------------------------|--|
| Door Prep | 2-1/8" diameter face hole & 1" diameter latch hole |
| Backset | Adjustable to 2-3/8" or 2-3/4" |
| Door Thickness | 1-3/8" to 2" automatic adjustment |
| Cylinder | SmartKey Security |
| Faceplate | 1" x 2-1/4". Round corner standard |
| Strikes | Round corner strike 1-1/8" x 2-3/4" |
| Bolt | 1" throw, steel deadbolt |
| Door Handing | Reversible |
| Batteries | 4 AA Alkaline |
| Wireless Communication | Z-Wave wireless technology |
| Operation | 908.42 MHz (US) |
| Range | Typical 100ft line of sight |

SMARTCODE™ 909, 913, POWERBOLT 2 DEADBOLT

| | |
|----------------|--|
| Function | Single cylinder deadbolt |
| Door Prep | 2-1/8" diameter face hole & 1" diameter latch hole |
| Backset | Adjustable to 2-3/8" or 2-3/4" |
| Door Thickness | 1-3/8" to 2" automatic adjustment |
| Cylinder | SmartKey Security |
| Faceplate | 1" x 2-1/4" round corner standard |
| Strikes | Round corner strike 1-1/8" x 2-3/4" |
| Bolt | 1" throw, steel deadbolt |
| Door Handing | Reversible |
| Batteries | 4 AA Alkaline |

HomeConnect™ 620

| | |
|-----------------------|---|
| Electrical: | |
| Input Power | 6V (4 x AA alkaline batteries) |
| Mechanical: | |
| Door Prep | 1 1/2" & 2 1/8" diameter bore hole & 1" deep latch hole |
| Backset | Adjustable 2 3/8" or 2 3/4" |
| Door Thickness | 1 3/8" - 2" automatic adjustment |
| Faceplates | 1" x 2 1/4" round corner standard |
| Strikes | Round corner strike 1 1/8" x 2 3/4" |
| Latch | Round corner adjustable 2 3/8" x 2 3/4" |
| Bolt | 1" throw, steel deadbolt |
| Door Handing | Reversible |
| Cylinder | SmartKey® Keyway |
| Environmental: | |
| Temperature Range | Exterior: -40°F to 150°F Interior: 32°F to 140°F |
| Humidity | Exterior: 100% condensing Interior: 30% - 95% non-condensing |

OBSDIAN 953 / 954

| | |
|----------------|---|
| Function | Single cylinder deadbolt |
| Door Prep | 1 1/2" & 2 1/8" diameter face hole & 1" diameter latch hole |
| Backset | Adjustable 2 3/8" or 2 3/4" |
| Door Thickness | 1 3/8" - 2" |
| Faceplates | 1" x 2 1/4" round corner standard |
| Strikes | Round corner |
| Latch | Round corner adjustable 2 3/8" x 2 3/4" |
| Bolt | 1" throw, steel deadbolt |
| Door Handing | Reversible |
| Batteries | 6V (4 AA alkaline batteries required) |

SMARTCODE™ 912 LEVER

| | |
|------------------------|--|
| Door Prep | 2-1/8" diameter face hole & 1" diameter latch hole |
| Backset | Adjustable to 2-3/8" or 2-3/4" |
| Door | 1-3/8" to 2" automatic adjustment |
| Thickness | |
| Cylinder | SmartKey Security |
| Faceplate | 1" x 2-1/4". Round corner standard |
| Strikes | 2-1/4" full lip. Round corner |
| Bolt | 1/2" throw |
| Door Handing | Reversible |
| Batteries | 4 AA Alkaline |
| Wireless Communication | Z-Wave wireless technology |
| Operation | 908.42 MHz (US) |
| Range | Typical 100ft line of sight |

SMARTCODE™ 915 / 916 & PREMIS™

| | |
|--------------|--|
| Function | Single cylinder deadbolt |
| Door Prep | 2-1/8" diameter face hole & 1" diameter latch hole |
| Backset | Adjustable to 2-3/8" or 2-3/4" |
| Door | 1-3/8" to 2-1/8" automatic adjustment |
| Thickness | |
| Cylinder | SmartKey Security |
| Faceplates | 1" x 2-1/4" round corner standard |
| Strikes | Round corner, 4 hole strike, 2-3/4" x 1-1/8" |
| Latch | Round corner adjustable 2-3/8" or 2-3/4" |
| Bolt | 1" throw, steel deadbolt |
| Door Handing | Reversible |
| Batteries | 4 AA Required |

SMARTCODE™ 917

| | |
|-------------------|---|
| Function | Keyed entry electronic lever |
| Door Prep | Cross Bore 2- 1/8". Edge Bore 1". |
| Backset | 2 3/8" or 2 3/4" |
| Door Thickness | 1 3/8" - 1 3/4" |
| Faceplates | 1" x 2 1/4" round corner standard, drive in available |
| Strikes | 2 1/4" full lip round corner |
| Latch | Adjustable 2 3/8" x 2 3/4" |
| Bolt | 1/2" throw, dead latch |
| Door Handing | Reversible for right or left-handed doors |
| Cylinder | SmartKey Security™ |
| UL Rating | 20 min |
| Temperature Range | Exterior: -40F to 150F Interior: 32F to 130F |
| Humidity | Exterior: - 100% condensing Interior: 30% - 95% non-condensing |

AURA™ DEADBOLT

| | |
|--------------|--|
| Door Prep | 2-1/8" diameter face hole & 1" diameter latch hole |
| Backset | Adjustable to 2-3/8" or 2-3/4" |
| Door | 1-3/8" to 2" automatic adjustment |
| Thickness | |
| Cylinder | SmartKey Security |
| Faceplate | 1" x 2-1/4". Round corner standard |
| Strikes | 2-3/4" x 1-1/8". Round corner 4 hole strike |
| Bolt | 1" throw |
| Door Handing | Reversible |
| Batteries | 4 AA Alkaline |

| | |
|-----------------|--|
| Function | Single cylinder deadbolt |
| Door Prep | 2 1/8" diameter face hole & 1" diameter latch hole |
| Latch Backset | Adjustable 2 3/8" or 2 3/4" |
| Door Thickness | Fits 1 3/8" - 1 3/4" door thickness |
| Latch Faceplate | 1" x 2 1/4" round corner standard |
| Strike | Round corner strike 2 3/4" x 1 1/8" |
| Bolt | 1" throw, steel deadbolt |
| Door Handing | Reversible |
| Batteries | Requires 4 X AA alkaline batteries |

OBSIDIAN™

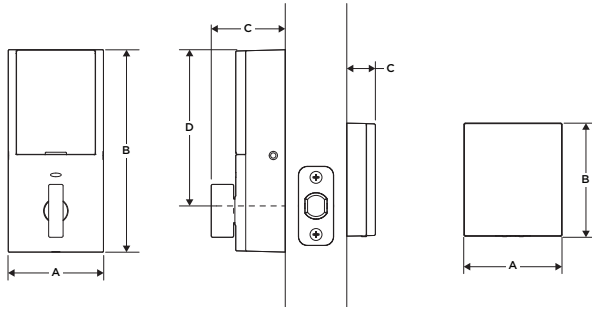

| Design | A | B | C | D |
|------------|----------|---------|---------|---------|
| Outer Trim | 2 11/16" | 5 3/4" | 2 3/32" | 4 9/16" |
| Inner Trim | 2 25/32" | 3 7/32" | 13/16" | --- |

SMARTCODE™ 916 CNT & PREMIS CNT

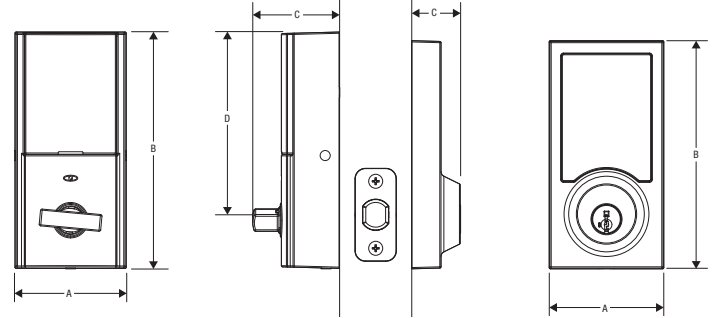

| Design | A | B | C | D |
|------------|----------|---------|----------|---------|
| Outer Trim | 2 11/16" | 5 3/4" | 2 3/32" | 4 9/16" |
| Inner Trim | 2 25/32" | 5 7/32" | 1 13/16" | --- |

SMARTCODE™ 917 HNL

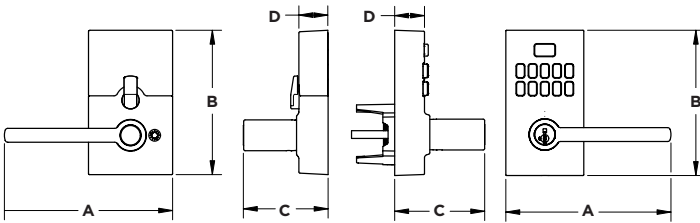

| Design | A | B | C | D |
|------------|---------|----------|----------|--------|
| Outer Trim | 5 9/16" | 4 29/32" | 3 1/32" | 1" |
| Inner Trim | 5 1/32" | 4 7/8" | 2 27/32" | 31/32" |

SMARTCODE™ 917 TNL

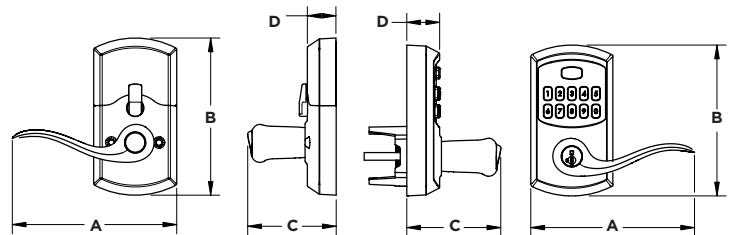

| Design | A | B | C | D |
|------------|---------|---------|----------|--------|
| Outer Trim | 5 9/32" | 5 5/32" | 3 3/32" | 1 1/8" |
| Inner Trim | 5 5/8" | 5 3/8" | 2 29/32" | 31/32" |

KWIKSET 905

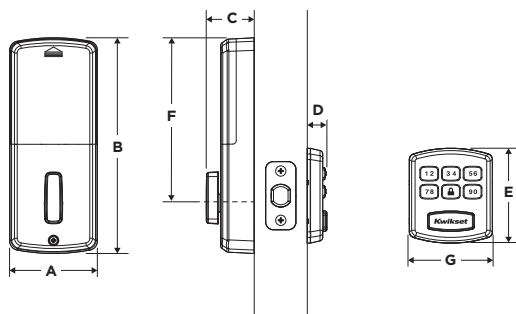

| Design | A | B | C | D | E | F | G |
|------------|-----|--------|----------|--------|--------|----------|----------|
| Outer Trim | --- | --- | --- | --- | 3 1/4" | --- | 2 27/32" |
| Inner Trim | 3" | 7 3/8" | 1 21/32" | 11/16" | --- | 5 19/32" | --- |

AURA

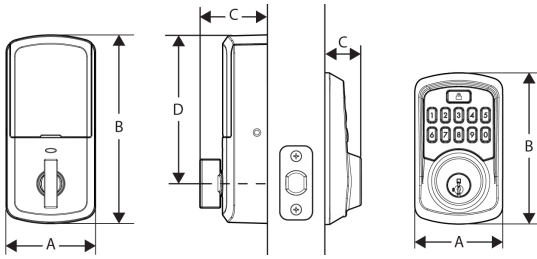

| Design | A | B | C | D |
|------------|----------|----------|---------|---------|
| Outer Trim | 2 3/4" | 5 13/16" | 2 1/8" | 4 9/16" |
| Inner Trim | 2 23/32" | 4 5/8" | 1 3/16" | --- |

SMARTCODE™ 913 CONTEMPORARY

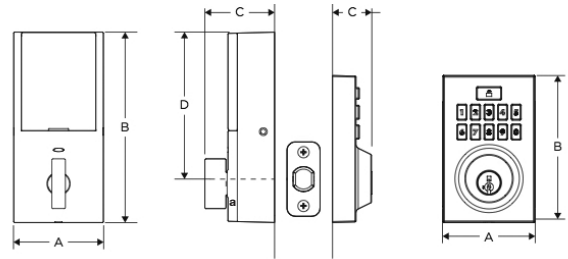

| Design | A | B | C | D |
|------------|----------|---------|---------|---------|
| Outer Trim | 2-25/32" | 4-7/16" | 1-3/16" | --- |
| Inner Trim | 2-11/16" | 5-3/4" | 2-3/32" | 4-9/16" |

SMARTCODE™ 915 / 916 & PREMIS™

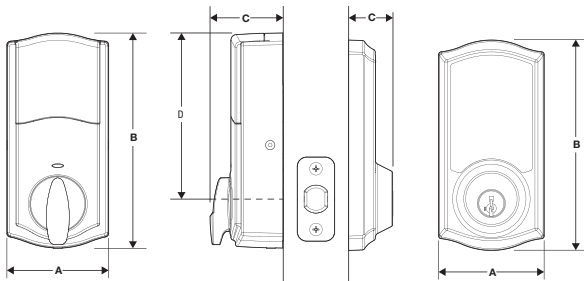

| Design | A | B | C | D |
|------------|----------|--------|----------|---------|
| Outer Trim | 2-13/16" | 5-3/8" | 1-3/16" | --- |
| Inner Trim | 2-3/4" | 5-3/4" | 1-15/16" | 4-9/16" |

SMARTCODE™ 913

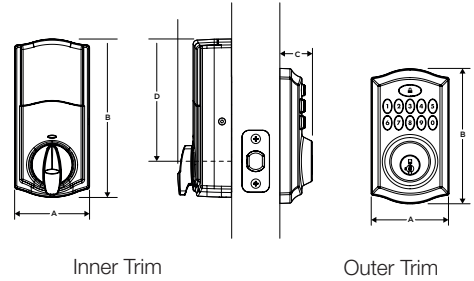

| Design | A | B | C | D |
|------------|--------|--------|---------|---------|
| Outer Trim | 2-7/8" | 5" | 1-3/16" | --- |
| Inner Trim | 2-3/4" | 5-3/4" | 2" | 4-7/16" |

SMARTCODE™ 912

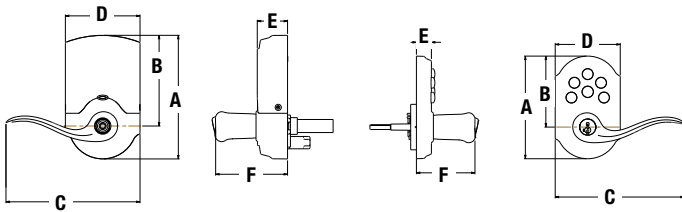

| Design | A | B | C | D | E | F |
|------------|----------|----------|----------|----------|---------|----------|
| Outer Trim | 4 7/16" | 3 1/16" | 5 19/32" | 2 13/16" | 2 1/32" | 2 17/32" |
| Inner Trim | 5 11/32" | 3 15/16" | 5 13/16" | 3 1/4" | 1 5/16" | 3 1/8" |

SMARTCODE™ 909

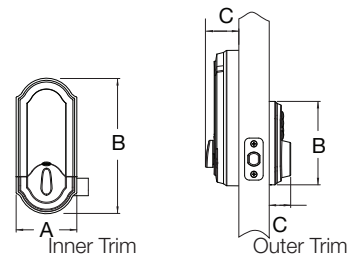

| Design | A | B | C |
|------------|----------|---------|---------|
| Outer Trim | 2-13/16" | 4-7/16" | 1-3/16" |
| Inner Trim | 3-1/4" | 7-1/4" | 1-3/4" |

Kwikset

KEY CONTROL™ D E A D B O L T

THE SMART ALTERNATIVE TO MASTER KEYING IN A NEW CONTEMPORARY STYLE

Re-keying & managing a traditional master key system is labor intensive, time consuming & costly. With the first & only two cylinder Key Control Deadbolt, either cylinder can be re-keyed in seconds, without removing the lock from the door.

Key Control

- Two separate cylinders, Tenant & Property Manager, allows for more tenant key cuts than a traditional master key system
- New proprietary keyway adds security - the tenant key will never fit into the Property Manager Cylinder
- The Property Manager Cylinder is concealed when not in use to avoid tenant confusion

Increased Efficiency

- Re-key the lock without removing from the door
- Save time & money by re-keying yourself
- Maintain key control throughout tenant and employee turnover



Perfect for multi-family dwellings, student housing, assisted living & rental properties.

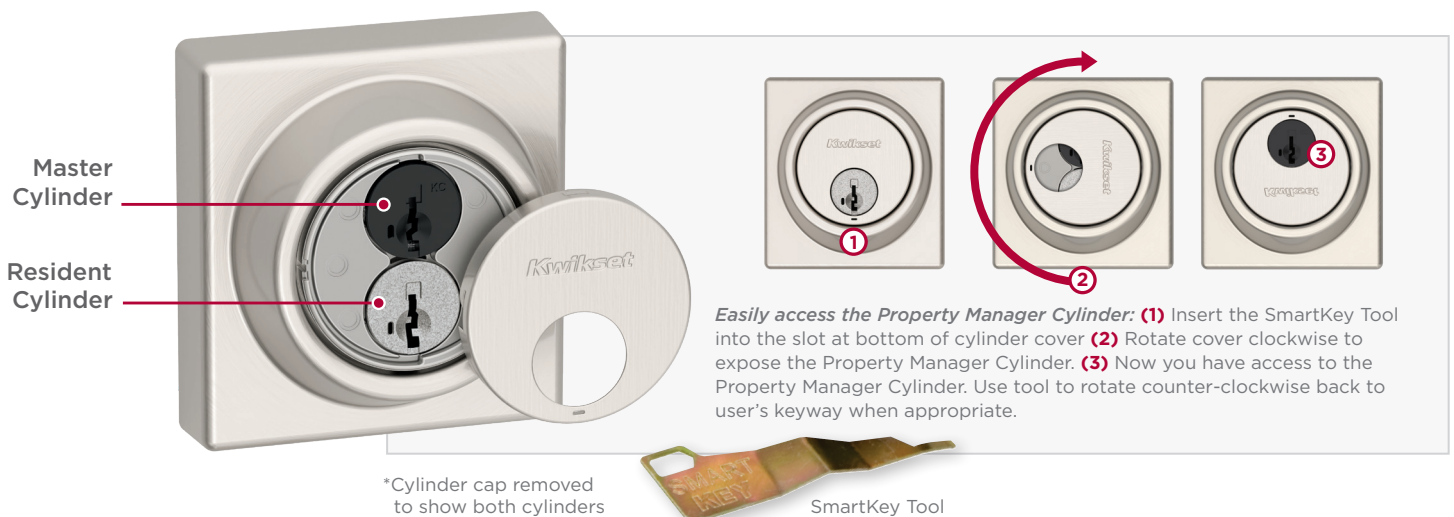

#1 SELLING U.S. LOCK BRAND*

*Source: TraQline US quarterly brand unit share report, Q4 2006 through Q2 2020

Interconnect Knobs & Levers - 780 Deadbolt Options



| Model | Function | Style | Finish | | | | | | | |
|---------|----------|--------------|----------|----------|----------|----------|----------|----------|----------|----------|
| | | | 3 | L03 | 5 | 11P | 15 | 15A | 26 | 26D |
| 506 | Entry | Hancock | \$257.60 | \$262.60 | \$257.60 | \$262.60 | \$262.60 | \$262.60 | \$262.60 | \$257.60 |
| | | Commonwealth | \$257.60 | \$262.60 | | \$262.60 | \$262.60 | | | |
| | | Tustin | \$257.60 | | \$257.60 | \$262.60 | \$262.60 | \$262.60 | \$262.60 | \$257.60 |
| | | Kingston | \$257.60 | | \$257.60 | | | | | \$257.60 |
| 506 SMT | Entry | Hancock | \$257.60 | \$262.60 | \$257.60 | \$262.60 | \$262.60 | \$262.60 | \$262.60 | \$257.60 |
| | | Commonwealth | \$257.60 | \$262.60 | | \$262.60 | \$262.60 | | | |
| | | Tustin | \$257.60 | | \$257.60 | \$262.60 | \$262.60 | \$262.60 | \$262.60 | \$257.60 |
| | | Kingston | \$257.60 | | \$257.60 | | | | | \$257.60 |
| 508 | Passage | Hancock | \$240.30 | \$245.30 | \$240.30 | \$245.30 | \$245.30 | \$245.30 | \$245.30 | \$240.30 |
| | | Commonwealth | \$240.30 | \$245.30 | | \$245.30 | \$245.30 | | | |
| | | Tustin | \$240.30 | | \$240.30 | \$245.30 | \$245.30 | \$245.30 | \$245.30 | \$240.30 |
| | | Kingston | \$240.30 | | \$240.30 | \$245.30 | \$245.30 | | | |
| 508 SMT | Passage | Hancock | \$240.30 | \$245.30 | \$240.30 | \$245.30 | \$245.30 | \$245.30 | \$245.30 | \$240.30 |
| | | Commonwealth | \$240.30 | \$245.30 | | \$245.30 | \$245.30 | | | |
| | | Tustin | \$240.30 | | \$240.30 | \$245.30 | \$245.30 | \$245.30 | \$245.30 | \$240.30 |
| | | Kingston | \$240.30 | | \$240.30 | \$245.30 | \$245.30 | | | \$240.30 |
| 508 SMC | Passage | Kingston | | | | \$247.80 | \$247.80 | | \$242.80 | |

- 506 & 505 interconnect functions utilize turn button locking
- Split finish options available

Interconnect Levers - 660 Deadbolt Options

| Model | Function | Style | Finish | | | | | | | |
|-------|----------|----------|----------|-----|----------|-----|----|-----|----|----------|
| | | | 3 | L03 | 5 | 11P | 15 | 15A | 26 | 26D |
| 505 | Entry | Kingston | \$239.10 | | \$239.10 | | | | | \$239.10 |

Interconnect Levers - Handleset Interior Pack Options

| Model | Function | Style | Finish | | | | | | | |
|-------|---------------|--------|--------|-----|---|----------|----------|-----|----|-----|
| | | | 3 | L03 | 5 | 11P | 15 | 15A | 26 | 26D |
| 502 | Interior Pack | Tustin | | | | \$155.00 | \$155.00 | | | |

Interconnect Key Control Deadbolt



| Model | Function | Style | Finish | | | | | | | |
|-----------------|----------|--------------|----------|-----|---|----------|----------|-----|----|----------|
| | | | 3 | L03 | 5 | 11P | 15 | 15A | 26 | 26D |
| 508 SMT KCDB | Passage | Hancock | \$247.30 | | | \$252.30 | \$252.30 | | | |
| | | Commonwealth | | | | \$252.30 | \$252.30 | | | |
| | | Tustin | \$247.30 | | | \$252.30 | \$252.30 | | | |
| | | Kingston | \$247.30 | | | \$252.30 | \$252.30 | | | \$247.30 |

Contemporary Interconnect Levers - 780 Deadbolt Options



| Model | Function | Style | Finish | | | | | | | |
|---------|----------|--------------|--------|---|----------|----------|-----|----------|----------|----------|
| | | | 3 | 5 | 11P | 15 | 15A | 26 | 26D | 514 |
| 506 SMT | Entry | Kingston CNT | | | | | | | | \$257.60 |
| | | Ladera CNT | | | \$262.60 | \$262.60 | | \$262.60 | \$257.60 | |
| 508 | Passage | Kingston CNT | | | \$245.30 | \$245.30 | | | \$240.30 | |
| | | Ladera CNT | | | \$245.30 | \$245.30 | | \$245.30 | \$240.30 | |
| 508 SMT | Passage | Kingston CNT | | | \$245.30 | \$245.30 | | | \$240.30 | \$250.70 |
| | | Ladera CNT | | | \$245.30 | \$245.30 | | \$245.30 | \$240.30 | \$250.70 |

Contemporary Interconnect Levers - 780 Deadbolt Options Split Style

| Model | Function | Style | Finish | | | | | | | | |
|---------|----------|--------------------------|--------|-----|---|----------|----------|-----|----|-----|----------|
| | | | 3 | L03 | 5 | 11P | 15 | 15A | 26 | 26D | |
| 506 SMT | Entry | Ladera LH X Kingston CNT | | | | | | | | | \$257.60 |
| | | Ladera RH X Kingston CNT | | | | | | | | | \$257.60 |
| 508 | Passage | Ladera LH X Kingston CNT | | | | \$245.30 | \$245.30 | | | | \$240.30 |
| | | Ladera RH X Kingston CNT | | | | \$245.30 | \$245.30 | | | | \$240.30 |
| 508 SMT | Passage | Ladera LH X Kingston CNT | | | | \$245.30 | \$245.30 | | | | \$240.30 |
| | | Ladera RH X Kingston CNT | | | | \$245.30 | \$245.30 | | | | \$240.30 |

Contemporary Interconnect Levers - Interior Pack Options

| Model | Function | Style | Finish | | | | | | | |
|-------|---------------|----------|--------|-----|---|----------|----------|-----|----------|----------|
| | | | 3 | L03 | 5 | 11P | 15 | 15A | 26 | 26D |
| 502 | Interior Pack | Ladera | | | | \$155.00 | \$155.00 | | \$155.00 | \$150.00 |
| 502 | Interior Pack | Kingston | | | | | | | | \$150.00 |

Key Control Deadbolt



| Model | Function | Finish | | | | | | | | | Case Qty |
|------------|-------------------------|---------|-----|---------|---------|---------|-----|---------|---------|---------|----------|
| | | 3 | L03 | 5 | 11P | 15 | 15A | 26 | 26D | 514 | |
| 816 SMT | Key Control Deadbolt | \$75.10 | | \$83.10 | \$83.10 | \$83.10 | | | \$83.10 | | 12 |
| 816 SMC | Key Control Deadbolt | \$77.60 | | | \$85.60 | \$85.60 | | | \$85.60 | | 12 |
| 817 SMT | Key Control Deadbolt UL | | | | \$90.10 | \$90.10 | | | \$90.10 | | 12 |
| 816 SQT | Single Cylinder | | | | | \$83.10 | | \$83.10 | | \$86.10 | 12 |
| 817 SQT UL | Single Cylinder UL | | | | | \$90.10 | | \$90.10 | | \$93.10 | 12 |

SmartCode™ 955





| Model | Description | Finish | | | | | | | | | Case Qty |
|-------|---------------------------|--------|-----|---|----------|----------|-----|----|----------|----------|----------|
| | | 3 | L03 | 5 | 11P | 15 | 15A | 26 | 26D | 514 | |
| 955 | Touchpad Electronic Lever | | | | \$237.00 | \$237.00 | | | \$237.00 | \$237.00 | 2 |

GRADE 2 LEVERS

| Kingston™ | Model | Function | Finish | | | | | | | |
|--|---------------|-----------------|---------------|------------|----------|------------|-----------|------------|-----------|------------|
| | | | 3 | L03 | 5 | 11P | 15 | 15A | 26 | 26D |
|  | 721KNL UL | Hall/Closet | \$56.30 | | | \$61.30 | \$61.30 | | | \$56.30 |
| | 733KNL UL | Bed/Bath | \$60.30 | | | \$65.30 | \$65.30 | | | \$60.30 |
| | 756KNL UL | Keyed entry UL | \$86.00 | | | \$91.00 | \$91.00 | | | \$86.00 |
| | 756KNL SMT UL | Keyed entry UL | \$86.00 | | | \$91.00 | \$91.00 | | | \$86.00 |
| | 756KNL SMC UL | Keyed Entry UL | \$88.50 | | | \$93.50 | \$93.50 | | | \$88.50 |
| | 781KNL UL | Storeroom UL | \$89.00 | | | \$94.00 | \$94.00 | | | \$89.00 |
| | 781KNL SMT UL | Storeroom UL | \$89.00 | | | \$94.00 | \$94.00 | | | \$89.00 |
| | 788KNL | Half Dummy | \$28.15 | | | \$30.65 | \$30.65 | | | \$28.15 |

GRADE 3 LEVERS

| Carson™ | Model | Function | Finish | | | | | | | |
|--|---------------|-----------------|---------------|------------|----------|------------|-----------|------------|-----------|------------|
| | | | 3 | L03 | 5 | 11P | 15 | 15A | 26 | 26D |
|  | 407CNL | Passage UL | \$40.70 | | | \$45.70 | \$45.70 | | | \$40.70 |
| | 408CNL | Privacy UL | \$44.70 | | | \$49.70 | \$49.70 | | | \$44.70 |
| | 438CNL UL | Entry UL | \$70.40 | | | \$75.40 | \$75.40 | | | \$70.40 |
| | 438CNL SMT UL | Entry UL | \$70.40 | | | \$75.40 | \$75.40 | | | \$70.40 |
| | 438CNL SMC UL | Entry UL | | | | | \$77.90 | | | \$72.90 |
| | 439CNL UL | Storeroom UL | \$73.40 | | | \$78.40 | \$78.40 | | | \$73.40 |
| | 439CNL SMT UL | Storeroom UL | \$73.40 | | | \$78.40 | \$78.40 | | | \$73.40 |
| | 488CNL | Half Dummy | \$20.35 | | | \$22.85 | \$22.85 | | | \$20.35 |

| Burbank™ | Model | Function | Finish | | | | | | | |
|--|--------------|-----------------|---------------|------------|----------|------------|-----------|------------|-----------|------------|
| | | | 3 | L03 | 5 | 11P | 15 | 15A | 26 | 26D |
|  | 407BBL | Passage UL | \$40.70 | | | \$45.70 | \$45.70 | | \$45.70 | |
| | 408BBL | Privacy UL | \$44.70 | | | \$49.70 | \$49.70 | | \$49.70 | |
| | 438BBL | Entry UL | \$70.40 | | | \$75.40 | \$75.40 | | \$75.40 | |
| | 439BBL | Storeroom UL | \$73.40 | | | \$78.40 | \$78.40 | | \$78.40 | |
| | 488BBL | Half Dummy | \$20.35 | | | \$22.85 | \$22.85 | | \$22.85 | |

| Palmina | Model | Function | Finish | | | | | | | |
|--|--------------|-----------------|---------------|------------|----------|------------|-----------|------------|-----------|------------|
| | | | 3 | L03 | 5 | 11P | 15 | 15A | 26 | 26D |
|  | 407PLL | Passage UL | | | | \$45.70 | \$45.70 | | \$45.70 | \$40.70 |
| | 408PLL | Bed/Bath UL | | | | \$49.70 | \$49.70 | | \$49.70 | \$44.70 |
| | 438PLL SMT | Entry SMT UL | | | | \$75.40 | \$75.40 | | \$75.40 | \$70.40 |
| | 488PLL | Half Dummy | | | | \$20.35 | \$20.35 | | \$20.35 | \$20.35 |

*For 438PLL Function must specify RH or LH when ordering

INTERCONNECT

| | |
|-------------------------|---|
| Door Prep | Crossbore 2-1/8" Edge Bore 1" 5-1/2 center-to-center only. |
| Backset | Must specify backset 2-3/8" or 2-3/4". |
| Door Thickness | 1-3/8" - 2-1/4" |
| Cylinder | <ul style="list-style-type: none"> 506, 508 - utilize 6-pin or SmartKey on 780 deadbolt. 505, 507 - utilize 5-pin on 660 deadbolt. 502 - determined by handleset ordered. SmartKey Security or Pin & Tumbler. |
| Faceplates | Complete locksets: No Default—must specify faceplate. 1" round corner, 1" square corner, 1-1/8 WFL square. Complete locksets: UL 3028, 3031, (WFL option 3846). |
| Strikes | Deadbolt Strike: UL 5278, 3223 (WFL 4632 opt.). |
| Door Handing | <ul style="list-style-type: none"> 506, 508, 505, 507 - reversible. 502 - specify handing. |
| ANSI/BHMA | <ul style="list-style-type: none"> 506, 508, 505, 507 - Grade 3 Certified. 502 - Determined by handleset ordered. |
| ADA | Lever options are in compliance with the American National Standards Institute (ANSI A117.1) and the Americans with Disabilities Act (ADA). |
| UL | Meets UL 3 hour fire rating for all functions except 502. |
| Interior Locking | <ul style="list-style-type: none"> Push button (for Kingston & Carson). Turn button (for Interconnect). |

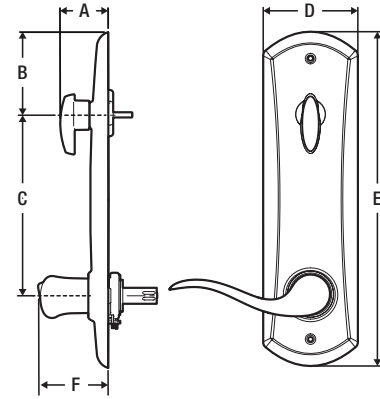

| Design | A | B | C | D | E | F |
|--------------|---------|----------|--------|----------|-----|----------|
| Interconnect | 1-7/16" | 2-15/32" | 5-1/2" | 2-53/64" | 10" | 2-31/32" |

CONTEMPORARY INTERCONNECT

| | |
|-----------------------|---|
| Door Prep | 2-1/8" diameter face hole & 1" diameter latch hole. |
| Backset | Must specify backset 2-3/8" or 2-3/4". |
| Door Thickness | 1-3/8" - 1-3/4" automatic adjustment. |
| Cylinder | <ul style="list-style-type: none"> 506 and 508 utilize 6-pin or SmartKey Security on 780 deadbolt. 505 utilize 5-pin on 660 deadbolt. 502 - determined by handleset ordered. |
| Faceplates | 1" x 2-1/4" round corner standard. |
| Strikes | Deadbolt Strike: UL 5278, 3223 (WFL 4632 opt.). |
| Door Handing | <ul style="list-style-type: none"> 506, 508, 505, 507 - reversible. 502 - specify handing. |
| ANSI/BHMA | <ul style="list-style-type: none"> 506, 508, 505 - Grade 3 Certified. 502 - Determined by handleset ordered. |
| ADA | Lever options are in compliance with the American National Standards Institute (ANSI A117.1) and the Americans with Disabilities Act (ADA). |
| UL | Meets 3 hour fire rating. |

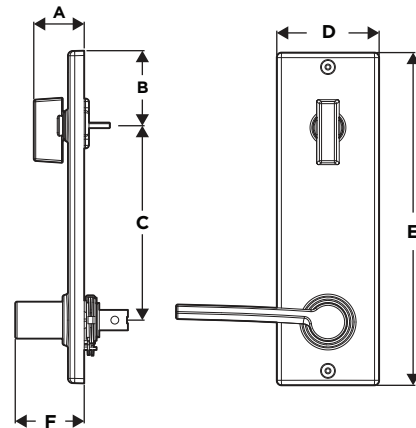

| Design | A | B | C | D | E | F |
|--------------|----------|---------|--------|----------|---------|----------|
| Interconnect | 1-13/32" | 2-1/16" | 5-1/2" | 2-27/32" | 9-3/16" | 1-29/32" |

KEY CONTROL

Standard Door Prep Cross Bore 2-1/8", Edge Bore 1"
Latch Face 1" x 2-1/4"

Door Thickness 1-3/4"

Cylinder 2 SmartKey Security™ cylinders: 1 standard Kwikset for users, 1 unique patented keyway for 1-Key Control

Faceplate 1" x 2-1/4"

Strike 1 1/4" x 3-5/8"

Bolt 1" throw

ANSI/BHMA A156.5 Grade 2

ADA Interior turn piece meets 4.13.9 ADA

UL Meets UL 3 hour fire rating for UL function. UL Ref# R10923

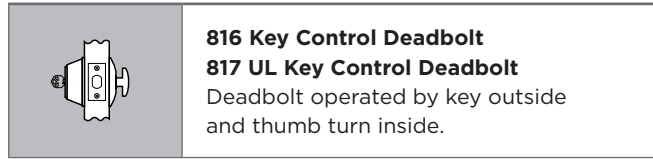

Traditional Design

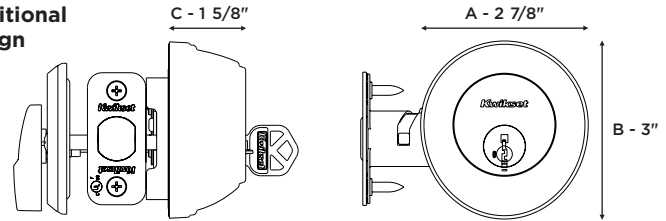

Contemporary Design

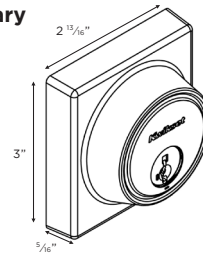

SMARTCODE 955

Function Keyed entry electronic lever

Door Prep 2 1/8" diameter face hole & 1" diameter latch hole

Backset Adjustable 2 3/8" or 2 3/4"

Door Thickness 1 3/8" - 1 3/4"

Faceplates 1" x 2 1/4" round corner standard

Strikes Round corner, 4 hole strike, 2 3/4" x 1 1/8"

Latch Round corner adjustable 2 3/8" x 2 3/4"

Bolt 1/2" throw, dead latch

Door Handing Reversible

Cylinder SmartKey Security™

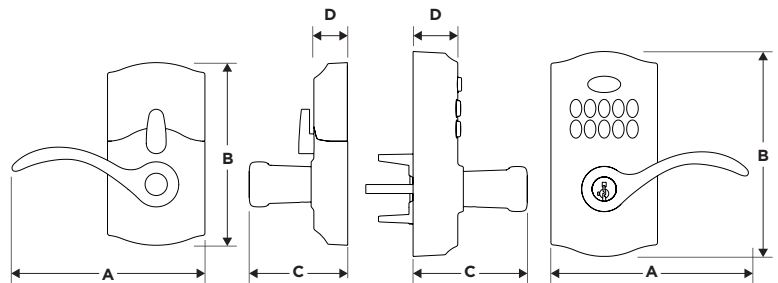

| Design | A | B | C | D |
|----------|--------------------|------------------------|----------------------|-----------------------|
| Interior | 5 5/8" (142.9) | 5 5/16" (134.9 mm) | 2 7/8" (73 mm) | 3 1/32" (24.6 mm) |
| Exterior | 5 3/4" (146 mm) | 5 31/32" (151.6 mm) | 3 5/16" (84.1 mm) | 1 13/32" (35.7 mm) |

KINGSTON LEVER

| | |
|------------------|---|
| ANSI/BHMA | Grade 2 Certified |
| Door Prep | Crossbore 2-1/8" Edge Bore 1" |
| Backset | Adjustable to 2-3/8" or 2-3/4". |
| Door Thickness | 1-3/8" – 1-3/4" doors standard |
| Cylinder | SmartKey Security or Pin & Tumbler. |
| Latch | Adjustable to 2-3/8" or 2-3/4" Specify round corner or square corner, WFL. |
| Strikes | 2-1/4" full lip UL. Specify round corner or square corner. Other options include 2-3/4" T-Strike and 4-7/8" ASA. |
| Bolt | 1/2" throw. |
| Door Handing | Reversible for right or left-hand doors. |
| ADA | Lever options are in compliance with the American National Standards Institute (ANSI A117.1) and the Americans with Disabilities Act (ADA). |
| UL | Meets UL 3 hour fire rating for all functions |
| Warranty | Lifetime Mechanical, 5 Year Finish |
| Interior Locking | Push button (for Kingston & Carson) Turn button (for Interconnect) |

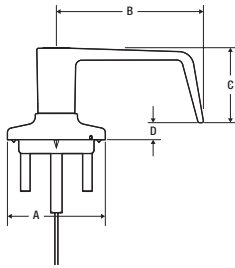

| Design | A | B | C | D |
|----------|-------|-------|-------|------|
| Kingston | 2.56" | 3.84" | 1.96" | .44" |

CARSON LEVER

| | |
|------------------|---|
| ANSI/BHMA | Grade 3 Certified |
| Door Prep | Crossbore 2-1/8" Edge Bore 1" |
| Backset | Adjustable to 2-3/8" or 2-3/4". |
| Door Thickness | 1-3/8" – 1-3/4" doors standard |
| Cylinder | SmartKey Security or Pin & Tumbler. |
| Latch | Adjustable to 2-3/8" or 2-3/4" Specify round corner or square corner, WFL. |
| Strikes | 2-1/4" full lip UL. Specify round corner or square corner. Other options include 2-3/4" T-Strike and 4-7/8" ASA. |
| Bolt | 1/2" throw. |
| Door Handing | Reversible for right or left-hand doors. |
| ADA | Lever options are in compliance with the American National Standards Institute (ANSI A117.1) and the Americans with Disabilities Act (ADA). |
| UL | Meets UL 3 hour fire rating for all functions |
| Warranty | Lifetime Mechanical, 5 Year Finish |
| Interior Locking | Push button (for Kingston & Carson) Turn button (for Interconnect) |

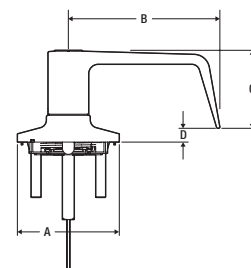

| Design | A | B | C | D |
|--------|-------|-------|-------|------|
| Carson | 2.56" | 3.80" | 1.96" | .35" |

BURBANK LEVER

| | |
|----------------|---|
| ANSI/BHMA | Grade 3 Certified |
| Door Prep | Crossbore 2-1/8" Edge Bore 1" |
| Backset | Adjustable to 2-3/8" or 2-3/4". |
| Door Thickness | 1-3/8" – 1-3/4" doors standard |
| Cylinder | Pin & Tumbler. |
| Latch | RCAL, SCAL, WFAL, NFL |
| Strikes | ASA-1 t-strike, Full Lip SCS UL, Full Lip 1/4" RCS UL, T Strike |
| Bolt | 1/2" throw. |
| Door Handing | Reversible for right or left-hand doors. |
| ADA | Lever options are in compliance with the American National Standards Institute (ANSI A117.1) and the Americans with Disabilities Act (ADA). |
| UL | Meets UL 3 hour fire rating for all functions |
| Warranty | Lifetime Mechanical, 5 Year Finish |

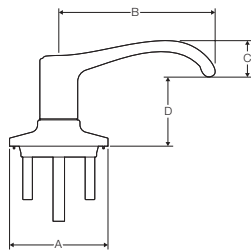

| Design | A | B | C | D |
|---------|------|-------|-------|-------|
| Burbank | 2.6" | 4.07" | 0.94" | 1.79" |

POCKET DOOR LOCKS,
SMARTKEY SECURITY
PADLOCKS, TRIMS
& INSTALLATION KIT

Round Pocket

| Door Lock | Model | Function | Finish | | | | | | | | | | Case Qty |
|---|-------|----------|--------|-----|---|---------|---------|-----|----|---------|---------|---------|----------|
| | | | 3 | L03 | 5 | 11p | 15 | 15A | 26 | 26D | 32 | 514 | |
|  | 334 | Passage | | | | \$40.70 | \$40.70 | | | \$40.70 | \$40.70 | \$40.70 | 12 |
| | 335 | Privacy | | | | \$44.80 | \$44.80 | | | \$44.80 | \$44.80 | \$44.80 | 12 |



Contemporary Pocket Door Lock

| Lock | Model | Function | Finish | | | | | | | | | | Case Qty |
|---|--------|----------|--------|-----|---|---------|---------|-----|----|---------|---------|---------|----------|
| | | | 3 | L03 | 5 | 11p | 15 | 15A | 26 | 26D | 32 | 514 | |
|  | 334CNT | Passage | | | | \$40.70 | \$40.70 | | | \$40.70 | \$40.70 | \$40.70 | 12 |
| | 335CNT | Privacy | | | | \$44.80 | \$44.80 | | | \$44.80 | \$44.80 | \$44.80 | 12 |



SmartKey Padlocks

| Part # | Model | Description | List Price | Case |
|---|---------------------------------|--|------------|------|
| | | | | Qty |
|  | 026SMT STD 1-1/8" SHKL PDL 50MM | SmartKey Security Padlock Standard Shackle | \$26.10 | 6 |
| | 026SMT LNG 2" SHKL PDL 50MM | SmartKey Security Padlock Long Shackle | \$27.30 | 6 |

* Keyed Alike 6

Trims







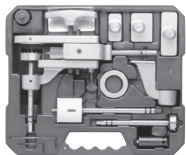

| Model | Description | Finish | | | | Pkg | Case | |
|---|-------------|---------------|---------|----|-----|---------|------|---|
| | | 3 | 5 | 15 | 26D | | Qty | |
|  | 293 | Round Rosette | \$18.80 | | | \$19.80 | CP | 4 |

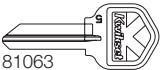
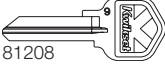
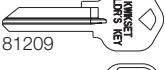
138 Installation Kit

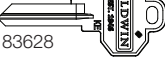



| Model | Description | Qty per Pack | Master Pk Qty | List Price |
|-----------|----------------------|--------------|---------------|------------|
| 91380-001 | 138 Installation Kit | 1 | 1 | \$658.50 |

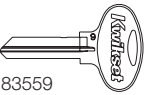
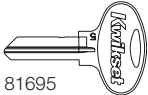
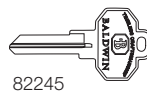

**Kwikset
Key Blanks**

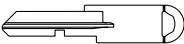
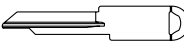
| | Model | Function | Qty | List Price |
|---|-----------|--|-----|------------|
|  | 81063-009 | K Bow, Nickel Plated, 5 Pin | 50 | \$1.80 |
|  | 81208-001 | K Bow, Nickel Plated, 6 Pin (UltraMax) | 50 | \$1.80 |
|  | 81209-001 | Solid Bow Builders Key, 6 Pin | 50 | \$1.80 |
|  | 81210-001 | Solid Bow Masters Key | 50 | \$1.80 |
|  | 82205-002 | Solid Bow Builders Key, 5 Pin | 50 | \$1.80 |
|  | 81693-001 | Do Not Duplicate Key | 50 | \$1.80 |
|  | 81693-002 | Do Not Duplicate keys (Cut Keys) | 50 | \$2.70 |
|  | 83559-008 | Large Bow, Builder Key, 6 Pin | 50 | \$1.80 |
|  | 81695-001 | Large Bow, Builder Key, 5 Pin | 50 | \$1.80 |
|  | 82245-001 | Baldwin K-Key | 50 | \$2.50 |
|  | 83628-001 | Baldwin C-Key | 50 | \$2.70 |
|  | 83559 | | | |
|  | 81695 | | | |
|  | 82245 | | | |

**Control Key Blanks
(Rekeying Tools)**

| | Model | Function | Qty | List Price |
|---|-----------|---|-----|------------|
|  | 87615-001 | Kwikset 6-Pin Knobs and Deadbolts | 50 | \$1.80 |
|  | 88122-001 | Kwikset 6-Pin Knobs and Deadbolts, MK | 50 | \$1.80 |
|  | 88485-005 | Kwikset Knobs and Deadbolts, Schlage® C | 12 | \$1.80 |
|  | 81804-001 | Kwikset Key-In Lever, Standard "TC" | 50 | \$1.80 |
|  | 89991-001 | Kwikset, Schlage® C | 50 | \$1.80 |

Emergency Key

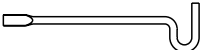
| | Model | Function | Qty | List Price |
|---|-----------|-----------------------------------|-----|------------|
|  | 81087-001 | For All Privacy Function Locksets | 100 | \$0.50 |

***NOTE:** Use Hex Wrench for push button privacy locksets.

Depth Key

| | Model | Function | Qty | List Price |
|---|-----------|---|-----|------------|
|  | 88596-001 | Depth Key Ring (Order in full pack quantities only) | 5 | \$9.70 |

**Extra Cut Keys
6 Pin**

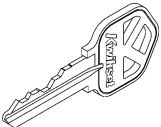
| | Model | Function | List Price |
|---|------------|------------------------------|------------|
| | Random Cut | Specify Cut | |
|  | 81208-002 | 90009-074 Regular Key | \$3.50 |
| | 81389-001 | Set of 2 Keys/ Ringed | \$5.60 |
| | 81211-001 | Set of 2 Keys w/ Control Key | \$5.60 |
| | 81210-002 | 90009-066 Master Key | \$4.60 |
| | 81209-002 | 90009-069 Builders Key | \$3.50 |
| | | 90009-082 Control key | \$1.80 |

**Extra Cut Keys
5 Pin**

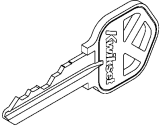
| | Model | Function | List Price |
|---|------------|------------------------|------------|
| | Random Cut | Specify Cut | |
|  | 81063-005 | Regular Key | \$2.30 |
| | 81057-007 | Set of 8 Keys/Ringed | \$21.40 |
| | 81057-002 | Set of 2 Keys/ Ringed | \$5.60 |
| | 85991-001 | 90009-003 Master Key | \$3.90 |
| | 82205-001 | 90009-004 Builders Key | \$3.30 |

***NOTE:** Must specify desired key cut when placing order.

**Keying Charges
& Supplies**

| Model | Function | Qty | List Price |
|-----------|---|-----|------------|
| 8497-75 | Kwikset Signature Series Knob, Schlage® keyway less cylinder cover (3, 26) | 6 | \$16.80 |
| 8497-76 | Kwikset Signature Series Knob, Weiser keyway less cylinder cover (3, 26) | 6 | \$16.80 |
| 81354 | Kwikset Signature Series Commonwealth Lever, Weiser cylinder (3, 26D) | 6 | \$23.90 |
| 81355 | Kwikset Signature Series Commonwealth Lever, Schlage cylinder (3, 26D) | 6 | \$23.90 |
| 81236 | 980/985 Deadbolt double cylinder cover - interior (15, 15A, 26, 26D, 3, 5, L03,11P) | 12 | \$1.50 |
| 81327 | 780/785 Deadbolt single cylinder cover - exterior (15, 15A, 26, 26D, 3, 5, L03,11P) | 12 | \$1.50 |
| 81328 | 780/785 Deadbolt double cylinder cover - interior (3, 5, 11P) | 12 | \$1.50 |
| 87748-001 | Knob plug - Kwikset 6 pin brass finish | 20 | \$2.00 |
| 87807-001 | Deadbolt plug - Kwikset Signature Series 6-pin brass finish | 20 | \$2.00 |
| 87807-002 | Deadbolt plug - Kwikset Signature Series 6-pin nickel finish | 20 | \$2.00 |
| 88485-005 | Rekeying Tool - Schlage® | 12 | \$1.50 |

NOTES:
Order in full pack quantities only. Must specify finish in order.
Competitive keying program not compatible with SmartKey product.

Keying Kits

| Model | Function | Qty | List Price |
|-----------|-----------------------------|-----|------------|
| 92360-001 | 236 Builder Pin Kit - small | 1 | \$169.40 |
| 92720-001 | 272 Pin Kit | 1 | \$299.40 |

**Specialty Keying
Charges**

| Code | Description | List Price |
|------|---------------------------------------|------------|
| MK | Master Keying | \$3.00 |
| PK | Builder Keying (Protecto) | \$3.00 |
| GMK | Grand Master Keying | \$8.50 |
| PMK | Builder Master Keying | \$5.30 |
| MAIS | Cross Keying / Maison Keying | \$6.30 |
| SEQ | Sequential Construction Master Keying | \$10.30 |

Replacement Parts for Kwikset Pin and Tumbler Keying

| Model | Pin Size | Qty | List Price |
|-----------|------------------------------------|-----|------------|
| 80049-001 | Key Gauge | 1 | \$7.90 |
| 80152-001 | Plug Follower | 1 | \$8.40 |
| 80369-001 | PK Anti-Pick Top Pin .160" | 100 | \$40.00 |
| 80370-001 | Regular Anti-Pick Top Pin .180" | 100 | \$40.00 |
| 80371-001 | Low Profile Deadbolt Spring Cover | 10 | \$1.40 |
| 81467-003 | Cylinder Removal Tool | 1 | \$2.00 |
| 81777-001 | Tumbler Spring | 100 | \$0.20 |
| 81858-001 | Regular Top Pin .180" | 100 | \$20.00 |
| 82208-001 | PK Balls | 100 | \$0.20 |
| 83100-001 | #1 Bottom Pin .172" | 100 | \$20.00 |
| 83101-001 | #2 Bottom Pin .195" | 100 | \$20.00 |
| 83103-001 | #3 Bottom Pin .218" | 100 | \$20.00 |
| 83105-001 | #4 Bottom Pin .241" | 100 | \$20.00 |
| 83106-001 | #5 Bottom Pin .264" | 100 | \$20.00 |
| 83107-001 | #6 Bottom Pin .287" | 100 | \$20.00 |
| 83108-001 | #1 Master Pin .023" | 100 | \$20.00 |
| 83110-001 | #2 Master Pin .046" | 100 | \$20.00 |
| 83112-001 | #3 Master Pin .069" | 100 | \$20.00 |
| 83113-001 | #4 Master Pin .092" | 100 | \$20.00 |
| 83114-001 | #5 Master Pin .115" | 100 | \$20.00 |
| 83117-001 | PK Top Pin .160" | 100 | \$20.00 |
| 83125-001 | #6 Master Pin .138" | 100 | \$20.00 |
| 83561-001 | Spring Cover (6-Pin) | 50 | \$1.30 |
| 84345-001 | Knob Plug Retainer | 100 | \$0.20 |
| 84215-001 | Deadlock Plug Retainer | 100 | \$0.20 |
| 85757-001 | Spring Cover (5-Pin) | 50 | \$1.30 |
| 87619-001 | Knob Control Lug (Locking Bar) | 100 | \$0.40 |
| 87632-001 | Spring | 100 | \$0.60 |
| 87809-001 | Deadlock Control Lug (Locking Bar) | 100 | \$0.70 |

Deadbolt Cylinders

| | Model | Function | List Price |
|--------------------------------|-----------|---|------------|
| | 90009-016 | 2776 - 665 Interior (5 Pin) | \$17.40 |
| | 90009-017 | 2777 - 665 Exterior (5 PIN) | \$17.40 |
| | 90009-041 | 15843 - 660 Exterior (5 Pin) | \$17.40 |
| | 90009-045 | 785 Exterior without Housing (6 PIN) | \$19.70 |
| | 90009-046 | 785 Interior without Housing | \$19.70 |
| <p>— Housing</p> <p>Core —</p> | 90009-010 | 87765 - 780 with Housing, Complete Assembly | \$25.30 |
| | 87894-001 | 07894-01 Housing Only, Outside | \$5.70 |
| | 90009-044 | 8325 - 780 Core without Housing | \$19.70 |
| <p>— Housing</p> <p>Core —</p> | 90009-019 | 7766 - 785 Exterior with Housing, Complete Assembly | \$25.30 |
| | 87894-001 | 07894-01 Housing Only, Outside | \$5.70 |
| <p>— Housing</p> <p>Core —</p> | 90009-020 | 7767 - 785 Interior with Housing, Complete Assembly | \$25.30 |
| | 90009-065 | 13443 980/ 993 CYL G1 (6 PIN) | \$51.30 |
| | 81227 | 13423 CVR CYL BDY EXT G1 | \$1.50 |
| | 90009-078 | 13448 985/994 CYL Interior (6 PIN) | \$52.60 |
| | 90009-079 | 13450 985/ 994 CYL Exterior (6 PIN) | \$51.30 |

Pin & Tumbler Knob Cylinders

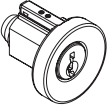
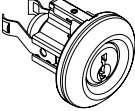
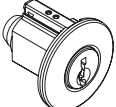
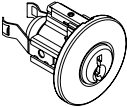
| | Model | Function | List Price |
|---|-----------|---|------------|
|  | 90009-011 | 7750A - Abbey (6 PIN) | \$16.00 |
|  | 90009-042 | 15860 - Polo (5 PIN) | \$21.40 |
|  | 90009-043 | 13752 - Hancock (6 PIN) | \$16.00 |
|  | 90009-013 | 1850 - All Other Kwikset and Kwikset Signatures Knobs | \$21.40 |

Pin & Tumbler Lever Cylinders

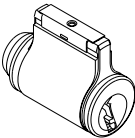
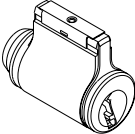
| | Model | Function | List Price |
|---|-----------|---|------------|
|  | 90009-077 | 24042 - 5-Pin P&T Cylinder | \$18.10 |
|  | 90009-076 | 21664 Kwikset Signatures Lever Cylinder (6 PIN) | \$18.10 |

Pin & Tumbler Light Commercial Lever Cylinders

| | Model | Function | List Price |
|--|-------|---|------------|
| | 83525 | 14831 Light Commercial Grade 2 P&T Entry Cylinder | \$15.80 |
| | 83011 | 14845 Light Commercial Grade 3 P&T Entry Cylinder | \$15.80 |
| | 83526 | 19496 Light Commercial Grade 2 P&T Storeroom Cylinder | \$15.80 |
| | 83528 | 19497 Light Commercial Grade 3 P&T Storeroom Cylinder | \$15.80 |

NOTE: Must specify finish when ordering cylinders

Smartkey Security Cylinders

| Model | Function | Finish | | | | | | | | | | List Price |
|-------|---|--------|---|---|--------|-----|----|-----|---------|-------|----|------------|
| | | LO3 | 3 | 5 | 15 | 15A | 26 | 26D | 690/11P | 514 | NA | |
| 83279 | SMT Knob/Lever Cylinder Only | Gold | | | Silver | | | | Bronze | Black | | \$23.40 |
| 83373 | SMT Deadbolt Cylinder Plug Only (Single Cylinder) | Gold | | | Silver | | | | Bronze | Black | | \$23.40 |
| 83025 | SMT Deadbolt Cylinder Only for 258 and 818 Model | Gold | | | Silver | | | | | Black | | \$23.40 |
| 83280 | SMT CN, C, H, T, CV Cylinder With Housing | • | | • | • | • | • | • | • | • | | \$23.40 |
| 83320 | SMT CA, A Cylinder With Housing | • | • | • | • | • | • | • | • | | | \$23.40 |
| 83281 | SMT 780/980 DB With Housing | • | • | • | • | • | • | • | • | | | \$52.10 |
| 83343 | SMT 660 DB with Housing | • | | • | • | • | • | • | • | | | \$25.00 |
| 83344 | SMT 665 DB with Housing Interior & Exterior | • | | • | • | • | • | • | • | | | \$50.00 |

Smartkey Security Re-Key Kits

| Model | Function | Finish | | | | | | | | | | List Price |
|-------|--|--------|-----|---|----|-----|----|-----|---------|-----|----|------------|
| | | 3 | LO3 | 5 | 15 | 15A | 26 | 26D | 690/11P | 514 | NA | |
| 83262 | Carded CP Rekey Kit (4 silver/2 brass) | | | | | | | | | | • | \$17.30 |
| 83335 | 4 cut keys with a rekey tool | | | | | | | | | | • | \$6.10 |
| 83336 | 6 cut keys with a rekey tool | | | | | | | | | | • | \$6.80 |

Smartkey Security Conversion Kits

| Model | Function | Finish | | | | | | | | | | List Price |
|-------|----------------------------------|--------|-----|---|----|-----|----|-----|---------|-----|----|------------|
| | | 3 | LO3 | 5 | 15 | 15A | 26 | 26D | 690/11P | 514 | NA | |
| 83325 | Abbey | • | • | • | • | • | • | • | • | | | \$30.50 |
| 83328 | Cameron, Hancock, Tylo, and Cove | • | • | • | • | • | • | • | • | • | | \$30.50 |
| 83377 | Polo | • | | • | • | • | • | • | • | | | \$30.50 |
| 83326 | 780/980/800 | • | • | • | • | • | • | • | • | • | | \$54.90 |
| 83327 | 785 | • | • | • | • | • | • | • | • | • | | \$76.10 |
| 83340 | 985 /801 | • | • | • | • | • | • | • | • | • | | \$76.10 |

Re-Keying Tools

| Model | Function | Finish | | | | | | | | | | List Price |
|-------|--------------------------------------|--------|-----|---|----|-----|----|-----|---------|-----|----|------------|
| | | 3 | LO3 | 5 | 15 | 15A | 26 | 26D | 690/11P | 514 | NA | |
| 83282 | Steel Learn Tool | | | | | | | | | | • | \$1.10 |
| 83283 | Red Plastic KW Learn Tool | | | | | | | | | | • | \$3.50 |
| 83576 | Learn Tool, T shape | | | | | | | | | | • | \$4.20 |
| 83260 | Reset Cradle | | | | | | | | | | | \$51.90 |
| 83338 | Large Knob/Lever C-clip (pack of 50) | | | | | | | | | | | \$38.10 |
| 83337 | Large Deadbolt C-clip (pack of 50) | | | | | | | | | | • | \$38.10 |
| 83374 | SmartKey Full Round Spindle | | | | | | | | | | • | \$1.20 |

Smartkey SC1 Security Cylinders

| Model | Function | Finish | | | | | | | | | | Case Qty | List Price |
|-------|----------|--|------|------|------|--------|--------|--------|---------|-------|-------|----------|------------|
| | | 3 | LO3 | 5 | 15 | 15A | 26 | 26D | 690/11P | 514 | | | |
| | 85170 | Dbl Cyl Deadbolts Exterior (554/801/985/785/159/689/665) | Gold | Gold | Gold | Silver | Silver | Silver | Silver | Black | Black | 100 | \$23.40 |
| | 85171 | Dbl Cyl Deadbolts Interior (967/976/979/985/785/159/689/665) | Gold | Gold | Gold | Silver | Silver | Silver | Silver | Black | Black | 100 | \$23.40 |
| | 85172 | "Knob/Levers (Half Round Chassis) Lever Electronics (917/955)" | Gold | Gold | Gold | Silver | Silver | Silver | Silver | Black | Black | 100 | \$23.40 |
| | 85200 | Levers (Square Drive Chassis) | Gold | Gold | Gold | Silver | Silver | Silver | Silver | Black | Black | 100 | \$23.40 |
| | 85173 | Sgl Cyl - Low Profile Deadbolts (818/258) | Gold | Gold | Gold | Silver | Silver | Silver | Silver | Black | Black | 100 | \$23.40 |
| | 85174 | Sgl Cyl Deadbolts (553/800/980/780/158/687/660) Electronic Deadbolts (888/907/909/913/915/916/919/925/938/939/942/953) | Gold | Gold | Gold | Silver | Silver | Silver | Silver | Black | Black | 100 | \$23.40 |

SmartKey SC1 Key Blanks

| Model | Function | QTY | List Price |
|-----------|---|-----|------------|
| 85178-001 | SC1, Kwikset, 5 Pin Key | 50 | \$85.10 |
| 85182-001 | SC1, Kwikset, Do Not Duplicate, 5 Pin Key | 50 | \$87.80 |

SmartKey SC1 Cut Keys

| Model | Function | CASE | List Price |
|-----------|---|------|------------|
| 85175-001 | SC1, Kwikset, Single 5 Pin Key | 100 | \$2.30 |
| 85176-001 | SC1, Kwikset, Four 5 Pin Keys on Ring, Learn Tool, SC1 Instructions | 100 | \$11.10 |
| 85177-001 | SC1, Kwikset, Four Sets of Two 5 Pin Keys on Ring | 100 | \$21.40 |
| 85183-001 | SC1, Kwikset, Do Not Duplicate, Single 5 Pin Key | 100 | \$3.30 |
| 90009-085 | SC1, Kwikset, Do Not Duplicate Key, Specific Cut | 100 | \$3.30 |

SmartKey SC1 Misc Service Parts

| Model | Function | Order QTY | QTY | List Price |
|-----------|--|-----------|-----|------------|
| 85179-001 | "Deadbolt Large C-Clip, 50 Pack (Used with 81574)" | 1 | 40 | \$38.10 |
| 85180-001 | SC1 Learn Tool & SC1 Instructions, 50 Pack | 1 | 20 | \$65.80 |
| 85181-001 | SC1 Reset Tool | 1 | 50 | \$26.00 |

Key Control Deadbolt Parts

| | Model | Function | Finish | | | | | Qty | List Price | |
|---|-------|---|--------|------|-----|--------|--------|-----|------------|---------|
| | | | 3 | 5 | 11P | 15 | 26D | | | N/A |
|  | 83382 | Key Control Deadbolt Key Blanks | | | | | | • | 10 | \$3.80 |
|  | 83383 | Key Control Deadbolt Cut Keys | | | | | | • | 10 | \$4.50 |
|  | 83389 | Key Control Deadbolt Cylinder Cover | • | • | • | • | • | | 1 | \$2.90 |
|  | 83390 | Key Control Deadbolt Mounting Screws | Gold | | | Silver | | | 1 | \$6.70 |
|  | 83388 | Key Control Deadbolt Torque Blade | | | | | | • | 10 | \$2.00 |
|  | 83386 | Key Control Deadbolt Gear Assembly | | | | | | • | 1 | \$7.50 |
|  | 83387 | Key Control Deadbolt Screws for Gear Assembly | | | | | | • | 1 | \$1.50 |
|  | 83395 | Key Control Deadbolt Tool | | | | | | • | 1 | \$4.50 |
|  | 83393 | Key Control Deadbolt Security Mounting Screws | Gold | Gold | | Silver | Silver | | 1 | \$4.50 |
|  | 83394 | Key Control Deadbolt Screw Torx Wrench | | | | | | • | 1 | \$6.00 |
|  | 83397 | Key Control Deadbolt Thin Door Kit | • | | | • | • | | 1 | \$14.80 |

Deadbolt Adjustable Latches

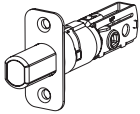
| | Model | Latch | Function | Finish | | | | | | | List Price | |
|---|-------|-------|--|--------|---|----|-----|--------|---------|-----|------------|---------|
| | | | | 3 | 5 | 15 | 15A | 26/26D | 690/11P | 514 | | NA |
|  | 81305 | RCAL | 660 Series Deadbolt Standard | • | • | • | • | • | • | | | \$11.60 |
| | 81258 | RCAL | 780/782/816/817/980/982 Series Deadbolt Standard UL 3 hour | • | | • | | • | • | | | \$29.80 |
| | 83347 | RCAL | 158/780/816/980 Deadbolt Standard | • | • | • | • | • | • | • | | \$18.00 |
| | 80391 | RCAL | Tapered Bolt Deadbolt* | • | | • | | | • | | | \$29.80 |

*Replacement Only

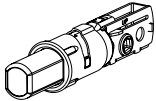
| | Model | Latch | Function | Finish | | | | | | | List Price | |
|---|-------|-------|--|--------|---|----|-----|--------|---------|-----|------------|---------|
| | | | | 3 | 5 | 15 | 15A | 26/26D | 690/11P | 514 | | NA |
|  | 81306 | RFAL | 660 Series Deadbolt Standard | | | | | | | | • | \$11.60 |
| | 83371 | RFAL | 158/780/816/980/982 Series Deadbolt Standard | | | | | | | | • | \$18.00 |
| | 80393 | RFAL | Tapered Deadbolt Latch Kit | • | | • | | | | • | | \$29.80 |

*Replacement Only

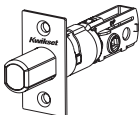
| | Model | Latch | Function | Finish | | | | | | | List Price | |
|---|-------|-------|--|--------|---|----|-----|--------|---------|-----|------------|---------|
| | | | | 3 | 5 | 15 | 15A | 26/26D | 690/11P | 514 | | NA |
|  | 81308 | SCAL | 660 Series Deadbolt Standard | • | • | • | • | • | • | | | \$11.60 |
| | 84513 | SCAL | 780/782 Series Deadbolt Standard UL 3 hour | • | • | • | • | • | • | | | \$18.00 |
| | 81257 | SCAL | 816/817/980/982 Series Deadbolt Standard UL 3 hour latch | • | | • | | • | • | | | \$29.80 |
| | 83370 | SCAL | 158/780/816/980 Series Deadbolt Standard | • | • | • | • | • | • | • | | \$18.00 |

*Replacement Only

| | Model | Latch | Function | Finish | | | | | | | List Price | |
|--|-------|-------|-------------------------------------|--------|---|----|-----|--------|---------|-----|------------|---------|
| | | | | 3 | 5 | 15 | 15A | 26/26D | 690/11P | 514 | | NA |
|  | 83002 | 4AL | 4AL 158/780/816/980 Series Deadbolt | | | | • | | • | • | | \$25.20 |

| | Model | Latch | Function | Finish | | | | | | | List Price | |
|---|-------|-------|-----------------------------|--------|---|----|-----|--------|---------|-----|------------|---------|
| | | | | 3 | 5 | 15 | 15A | 26/26D | 690/11P | 514 | | NA |
|  | 83023 | 6AL | 6AL 258/818 Series Deadbolt | | | • | | • | • | • | | \$24.30 |

Deadbolt Specialty Latches

| | Model | Latch | Function | Finish | | | | | | | List Price | |
|---|-------|-------|------------------------------------|--------|---|----|-----|--------|---------|-----|------------|---------|
| | | | | 3 | 5 | 15 | 15A | 26/26D | 690/11P | 514 | | NA |
|  | 82730 | 5L | 5" Kwikset (replacement part only) | • | • | | | • | | | | \$17.40 |

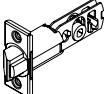
| | Model | Latch | Function | Finish | | | | | | | List Price | |
|---|-------|-----------|--------------------|--------|---|----|-----|--------|---------|-----|------------|---------|
| | | | | 3 | 5 | 15 | 15A | 26/26D | 690/11P | 514 | | NA |
|  | 83277 | Gatelatch | Gatelatch Standard | • | • | | | • | | | | \$28.60 |

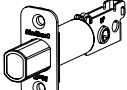
| | Model | Latch | Function | Finish | | | | | | | List Price | |
|---|-------|-------|----------------|--------|---|----|-----|--------|---------|-----|------------|---------|
| | | | | 3 | 5 | 15 | 15A | 26/26D | 690/11P | 514 | | NA |
|  | 82731 | RCL | 2-3/8" Backset | • | • | | | • | • | | | \$12.70 |
| | 82732 | RCL | 2-3/4" Backset | • | • | | | • | • | | | \$12.70 |

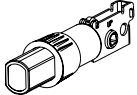
| | Model | Latch | Function | Finish | | | | | | | List Price | |
|---|-------|-------|----------------|--------|---|----|-----|--------|---------|-----|------------|---------|
| | | | | 3 | 5 | 15 | 15A | 26/26D | 690/11P | 514 | | NA |
|  | 82734 | RFL | 2-3/8" Backset | | | | | | | | • | \$12.70 |
| | 82735 | RFL | 2-3/4" Backset | | | | | | | | • | \$12.70 |

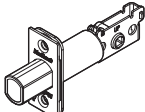
| | Model | Latch | Function | Finish | | | | | | | List Price | |
|---|-------|-------|----------------|--------|---|----|-----|--------|---------|-----|------------|---------|
| | | | | 3 | 5 | 15 | 15A | 26/26D | 690/11P | 514 | | NA |
|  | 82728 | SCL | 2-3/8" Backset | • | • | | | • | • | | | \$12.70 |
| | 82729 | SCL | 2-3/4" Backset | • | • | | | • | • | | | \$12.70 |

Adjustable Latches (Square Drive)

| | Model | Latch | Function | Finish | | | | | | | | List Price |
|--|-------|-------|---|--------|---|----|-----|--------|---------|-----|----|------------|
| | | | | 3 | 5 | 15 | 15A | 26/26D | 690/11P | 514 | NA | |
| | 83480 | 6AL | 6AL Plain Latch HFL ,MIL, LSL, MRL, SYL, SAL | | | • | | • | • | • | | \$15.10 |
| | 83000 | 6AL | 6AL Deadlatch BBL, KNL, CNL, HFL, MIL, LSL, MRL, PLL, SYL , SAL | | | • | | • | • | • | | \$16.40 |
| | 83521 | RCAL | RCAL Plain Latch UL 3 hour BBL, KNL, CNL, PLL | • | | • | | • | • | | | \$12.90 |
| | 83518 | RCAL | RCAL Deadlatch UL 3 HOUR BBL, KNL, CNL, HFL, MIL, LSL, MRL, PLL, SYL, SAL | • | | • | | • | • | | | \$15.00 |
| | 83522 | WFAL | WFAL SCL Plain Latch UL 3 hour BBL, KNL, CNL, PLL | • | | • | | • | • | | | \$12.90 |
| | 83010 | WFAL | WFAL SCL Deadlatch UL 3 hour BBL, KNL, CNL, HFL, MIL, LSL, MRL, PLL, SYL, SAL | • | | • | | • | • | | | \$15.00 |
| | 83520 | SCAL | SCAL Plain Latch UL 3 HOUR BBL, KNL, CNL, PLL | • | | • | | • | • | | | \$12.90 |
| | 83517 | SCAL | SCAL Deadlatch UL 3 HOUR BBL, KNL, CNL, HFL, MIL, LSL, PLL, SAL | • | | • | | • | • | | | \$15.00 |

Adjustable Latches (Half-Round Drive)

| | Model | Latch | Function | Finish | | | | | | | | List Price |
|--|-------|------------|-------------------------------------|--------|---|----|-----|--------|---------|-----|----|------------|
| | | | | 3 | 5 | 15 | 15A | 26/26D | 690/11P | 514 | NA | |
| | 81825 | 6AL | 6AL Deadlatch | • | • | | | • | | | | \$15.00 |
| | 81826 | 6AL | 6AL Plain Latch | • | • | | | • | | | | \$12.90 |
| | 82246 | RCAL | RCAL Plain Latch | • | • | • | • | • | • | • | | \$12.90 |
| | 82247 | RCAL | RCAL Deadlatch | • | • | • | • | • | • | • | | \$15.00 |
| | 81846 | Core Latch | Adjustable Latch Core - Deadlatch | | | | | | | | • | \$11.00 |
| | 81847 | Core Latch | Adjustable Latch Core - Plain Latch | | | | | | | | • | \$7.80 |



Key:

| | |
|---|---------------------------------------|
| 5L - 5" Latch | RFAL - Round Face Adjustable Latch |
| RCL - Round Corner Latch | SCAL - Square Corner Adjustable Latch |
| RFL - Round Face Latch (Drive-In Collar attached) | WFAL - Wide Face Adjustable Latch |
| SCL - Square Corner Latch | NFAL - Narrow Face Adjustable Latch |
| RCAL - Round Corner Adjustable Latch | FD - Latch |

NOTES:

For BBL, KNL, CNL, HFL, MIL, PLL, MRL, LSL, and SYL products use square drive plain and deadlatches. All other Kwikset & Kwikset Signature knob and lever products use half-round plain and deadlatches. Plainlatches are used with passage and privacy functions. Deadlatches are used with entry functions. All fronts are 2-1/4" high. For fire rating, UL latches must be used with UL listed locksets and applicable strikes. UL Kwikset and Kwikset Signatures are rated for 3 hours, unless otherwise specified. Optional UL 1/3 hour fire rating is available for all functions (FD).

Half Round Latch Parts

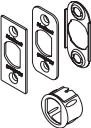
| | Model | Latch | Function | Finish | | | | | | | List Price | |
|---|---|-----------------|-------------------------------|--------|---|----|-----|--------|---------|-----|------------|--------|
| | | | | 3 | 5 | 15 | 15A | 26/26D | 690/11P | 514 | | NA |
|  | 81827 | Back Plate | 6-Way Back Plate | | | | | | | | • | \$0.20 |
| | * For use with Kwikset Half Round Latches | | | | | | | | | | | |
|  | 81828 | Drive In Collar | 6-Way Deadlatch Collar | | | | | | | | • | \$2.10 |
| | 81829 | Drive In Collar | 6-Way Plain Latch Collar | | | | | | | | • | \$2.10 |
| | * For use with Kwikset Half Round Latches | | | | | | | | | | | |
|  | 81844 | Service Kit | 6-Way Deadlatch Service Kit | • | • | • | • | • | • | • | | \$5.40 |
| | 81845 | Service Kit | 6-Way Plain Latch Service Kit | • | • | • | • | • | • | • | | \$4.10 |
| | * For use with Kwikset Half Round Latches | | | | | | | | | | | |

Specialty Deadlatches

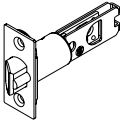
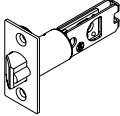
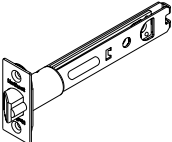
| | Model | Latch | Function | Finish | | | | | | | List Price | |
|---|-------|---------|----------------------------------|--------|---|----|-----|--------|---------|-----|------------|---------|
| | | | | 3 | 5 | 15 | 15A | 26/26D | 690/11P | 514 | | NA |
|  | 84292 | SCDL | 2-3/4" Backset - UL 3 hour | • | • | • | • | • | • | | | \$27.70 |
| | 84297 | SCDL | 2-3/8" Backset - UL 3 hour | • | • | • | • | • | • | | | \$27.70 |
|  | 84255 | WFDL | 2-3/4" Backset - UL 3 hour | • | • | • | • | • | • | | | \$27.70 |
| | 84295 | WFDL | 2-3/8" Backset - UL 3 hour | • | • | • | • | • | • | | | \$27.70 |
|  | 83014 | 5L SCDL | 5" Latch (replacement part only) | • | • | | | • | | | | \$20.10 |

Specialty Plainlatches

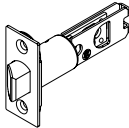
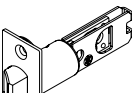
| | Model | Latch | Function | Finish | | | | | | | List Price | |
|---|-------|-------|---------------------|--------|---|----|-----|--------|---------|-----|------------|---------|
| | | | | 3 | 5 | 15 | 15A | 26/26D | 690/11P | 514 | | NA |
|  | 84290 | SCPL | 2-3/4" Backset - UL | • | • | • | • | • | • | | | \$20.90 |
| | 84296 | SCPL | 2-3/8" Backset - UL | • | • | • | • | • | • | | | \$20.90 |
|  | 84254 | WFPL | 2-3/4" Backset - UL | • | • | • | • | • | • | | | \$20.90 |
| | 84294 | WFPL | 2-3/8" Backset - UL | • | • | • | • | • | • | | | \$20.90 |

| | | |
|-------------|---|---------------------------------------|
| KEY: | 5L - 5" Latch | RFAL - Round Face Adjustable Latch |
| | DL - Deadlatch | SCAL - Square Corner Adjustable Latch |
| | RC - Round Corner | SCDL - Square Corner Deadlatch |
| | SC - Square Corner | SCPL - Square Corner Plainlatch |
| | RCL - Round Corner Latch | WFAL - Wide Face Adjustable Latch |
| | RFL - Round Face Latch (Drive In Collar attached) | WFDL - Wide Face Deadlatch |
| | SCL - Square Corner Latch | WFPL - Wide Face Plainlatch |
| | RCAL - Round Corner Adjustable Latch | FD - Latch |



**Plainlatch and
Deadlatch**

| | Model | Function | Finish | | | | | | | List Price |
|---|---------|---|--------|---|----|-----|--------|---------|-----|------------|
| | | | 3 | 5 | 15 | 15A | 26/26D | 690/11P | 514 | |
| | | | | | | | | | | |
| | 80318 | Full Round, Adjustable Strike (500 Per Box) | • | • | | • | | | | \$2,014.10 |
| | 80318 | Full Round, Adjustable Strike (500 Per Box) | | | • | | • | • | | \$2,769.40 |
| | | | | | | | | | | |
| | 83028** | T (30 per carton) | • | • | • | • | • | • | • | \$3.90 |
| Standard on 588, 589 and UL Listed Knob and Lever sets. Add \$0.45 elsewhere. | | | | | | | | | | |
| | | | | | | | | | | |
| | 83030** | Full Lip Square Corner Strike, UL | • | • | • | • | • | • | • | \$5.10 |
| | | | | | | | | | | |
| | 83031** | Full Lip 1/4" Round Corner Strike, UL | • | • | • | • | • | • | • | \$5.10 |
| | | | | | | | | | | |
| | 83437* | Full Lip Square Corner | • | • | • | • | • | • | • | \$3.90 |
| *Standard on Non-UL Locksets | | | | | | | | | | |
| | | | | | | | | | | |
| | 83796* | Full Lip 1/4" Round Corner (RCS4) | • | • | • | • | • | • | • | \$3.90 |
| | | | | | | | | | | |
| | 83846** | ASA-1 (30 per carton) | • | • | • | • | • | • | • | \$12.20 |
| *Add \$4.90 to Knob and Lever sets | | | | | | | | | | |
| | | | | | | | | | | |
| | 83929 | Full Round 1- 3/4" | • | • | • | • | • | • | • | \$3.90 |
| | | | | | | | | | | |
| | 83536 | Round Corner Extended Lip Strike 2-1/4" Qty 10 | • | | • | | • | • | | \$3.90 |
| | | | | | | | | | | |
| | 83537 | Square Corner Extended Lip Strike 2-1/4" Qty 10 | • | | • | | • | • | | \$3.90 |
| | | | | | | | | | | |
| | 83534 | Round Corner Adjustable Strike 2-1/4" | • | | • | | • | • | | \$3.90 |

NOTES:

*20-minute fire rating with UL locks and latchbolts.

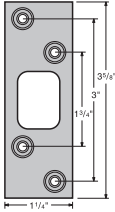
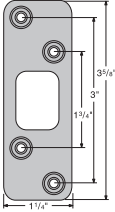
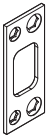
** 3-hour fire rating with UL Kwikset Signatures and 1.5 hour fire rating with UL Kwikset locks and latchbolts.

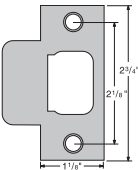
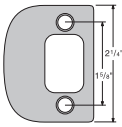
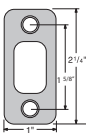
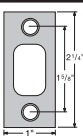
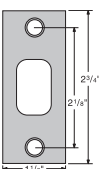
| Deadbolt Strikes Model | Function | Finishes | | | | | | | | List Price |
|---|--|---|---|----|-----|--------|---------|-----|----|------------|
| | | 3 | 5 | 15 | 15A | 26/26D | 690/11P | 514 | NA | |
|  | 83222** | Square Corner Strike: Used on Grade 2 Deadbolts | • | • | • | • | • | • | • | \$4.60 |
| | 780, 785, 980, 985, 258, 800, 801, 553, 554, 818 Deadbolts. Add \$1.45 to 660 Series Deadbolts | | | | | | | | | |
|  | 83223** | Round Corner Strike: Used on Grade 2 Deadbolts | • | • | • | • | • | • | • | \$4.60 |
| | 780, 785, 980, 985, 258, 800, 801, 553, 554, 818 Deadbolts. Add \$1.45 to 660 Series Deadbolts | | | | | | | | | |
|  | 820049** | Square Corner Strike: Used on Grade 1 Deadbolts | • | • | • | • | • | • | • | \$4.60 |
| | 780, 785, 980, 985, 258, 800, 801, 553, 554, 818 Deadbolts. Add \$1.45 to 660 Series Deadbolts | | | | | | | | | |
|  | 820050** | Round Corner Strike: Used on Grade 1 Deadbolts | • | • | • | • | • | • | • | \$4.60 |
| | 780, 785, 980, 985, 258, 800, 801, 553, 554, 818 Deadbolts. Add \$1.45 to 660 Series Deadbolts | | | | | | | | | |
|  | 84632** | Deadbolt T-Strike (60 per carton) | • | • | • | • | • | • | • | \$3.90 |
| | | | | | | | | | | |
|  | 84638** | Deadbolt, Full Lip | • | • | • | • | • | • | • | \$3.90 |
| | | | | | | | | | | |
|  | 85063** | Deadbolt 1"x 2-1/4" Round Corner (RCS4) | • | • | • | • | • | • | • | \$3.90 |
| | Standard on 660, 665 Deadbolts. | | | | | | | | | |
|  | 85072** | Deadbolt 1"x 2-1/4" | • | • | • | • | • | • | • | \$3.90 |
| | Standard on 660, 665 Deadbolts. | | | | | | | | | |
|  | 85278** | Deadbolt, 1-1/8" x 2-3/4" | • | • | • | • | • | • | • | \$3.90 |
| | Standard on 782, 784 Deadbolts. | | | | | | | | | |

Deadbolt Strikes **Model** **Function** **Finishes** **List Price**

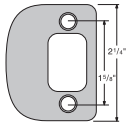

| Model | Function | 3 | 5 | 15 | 15A | 26/26D | 690/11P | 514 | NA | List Price |
|---------|---------------------------------|---|---|----|-----|--------|---------|-----|----|------------|
| 85303** | Deadbolt, Full lip Round Corner | • | • | • | • | • | • | • | | \$3.90 |

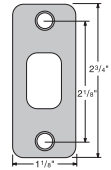

| Model | Function | 3 | 5 | 15 | 15A | 26/26D | 690/11P | 514 | NA | List Price |
|---------------------------------|--|---|---|----|-----|--------|---------|-----|----|------------|
| 85279** | Deadbolt, 1-1/8" x 2-3/4" Round Corner | • | • | • | • | • | • | • | | \$3.90 |
| Standard on 782, 784 Deadbolts. | | | | | | | | | | |

Strike Boxes **Model** **Function** **Finishes** **List Price**

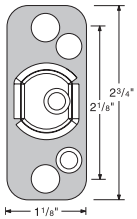

| Model | Function | 3 | 5 | 15 | 15A | 26/26D | 690/11P | 514 | NA | List Price |
|-------|---------------------------|---|---|----|-----|--------|---------|-----|----|------------|
| 81225 | Box for 5278/5279 Strikes | | | | | | | | • | \$4.10 |

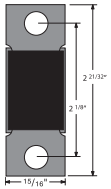

| Model | Function | 3 | 5 | 15 | 15A | 26/26D | 690/11P | 514 | NA | List Price |
|-------|------------------------|---|---|----|-----|--------|---------|-----|----|------------|
| 81231 | Box for 83028 T Strike | | | | | | | | • | \$1.20 |

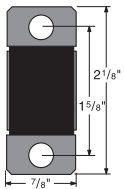

| Model | Function | 3 | 5 | 15 | 15A | 26/26D | 690/11P | 514 | NA | List Price |
|--|---------------------------|---|---|----|-----|--------|---------|-----|----|------------|
| 83288 | Box for Full Lip Strikes* | | | | | | | | • | \$1.70 |
| *Add \$0.45 to locksets using full lip strike. | | | | | | | | | | |

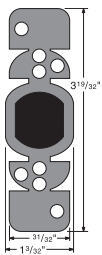

| Model | Function | 3 | 5 | 15 | 15A | 26/26D | 690/11P | 514 | NA | List Price |
|-------|------------------------------|---|---|----|-----|--------|---------|-----|----|------------|
| 81640 | Box for all Deadbolt Strikes | | | | | | | | • | \$1.20 |
| 81967 | Box for 83846 ASA-1 Strike | | | | | | | | • | \$5.50 |

NOTES:

*20-minute fire rating with UL locks and latchbolts.

** 3-hour fire rating with UL Kwikset Signatures and 1.5 hour fire rating with UL Kwikset locks and latchbolts.

Knobs and Levers



| Model | Function | Finish | | | | | | List Price | |
|--------|--|--------|---|--------|--------|---------|-----|------------|--------|
| | | 3 | 5 | 15/15A | 26/26D | 690/11P | 514 | | NA |
| 81834 | Signature Lever Screw Pack Styles: A, CA, H, L | | | | | | | • | \$1.20 |
| 81835 | Signature Lever Screw Pack Styles: ADL, AVL, BRL, CHL, KTL, LL, PML, TNL, VDL/Kwikset Screw Pack Styles BL, DL, DNL, LRL | • | | • | • | • | • | | \$0.60 |
| 83369 | Signature Lever Screw Pack Styles: C, CN, PE/Kwikset Screw Pack Styles: CV, P, T | • | | | | | | | \$0.60 |
| 83001 | Signatures Entry Lever Screw Pack Functions: 156 | | | • | • | • | | | \$5.60 |
| 820284 | Signatures Passage & Privacy Lever Screw Pack Functions: 154, 155 | | | | | | | | \$3.80 |
| 85201 | Signature Screw Pack: KAL | | | • | | | | • | \$1.20 |
| 85202 | Thick Door Signature Screw Pack: KAL | | | • | | | | • | \$6.00 |
| 83523 | Light Commerical Screw Pack: Kingston | • | | • | • | • | | | \$4.10 |
| 83524 | Light Commerical Screw Pack: BBL, CNL, PLL | • | | • | • | • | | | \$4.10 |
| 83258 | Lever Set Screw With Hex Wrench (3/32") | | | | | | | • | \$0.70 |
| 83398 | Lever Set Screw With Hex Wrench for MRL, SYL, HFL, LSL, MIL | | | | | | | • | \$6.30 |

NOTES:

*If 15 or 15A not available, 515 (Gray Chromate) is the default finish

Reversible Leverset Screws



| Model | Function | Finishes | | | | | | List Price | |
|-------|------------------------------------|----------|---|--------|--------|---------|-----|------------|--------|
| | | 3 | 5 | 15/15A | 26/26D | 690/11P | 514 | | NA |
| 83254 | Passage/Provacy/Interior Entry SMT | | | | | | | • | \$0.20 |
| 83255 | Interior Pin & Tumbler Entry | | | | | | | • | \$0.20 |
| 83256 | Exterior Entry Pin & Tumbler & SMT | | | | | | | • | \$0.20 |
| 83257 | Exterior Entry SMT | | | | | | | • | \$0.20 |

Handlesets



| Model | Function | Finish | | | | | | List Price | |
|-------|---|--------|---|--------|--------|---------|-----|------------|--------|
| | | 3 | 5 | 15/15A | 26/26D | 690/11P | 514 | | NA |
| 86151 | Kwikset Handleset Screw Pack Styles: A, CA, H, L, ADL, AVL, BRL, CHL, PML, CE, AVH, ADH, SE, HE | • | • | • | • | • | • | | \$1.60 |
| 82215 | Signatures Handleset Decorative Interior Screw Cap Cover: ADH, AVH, AT, AUH, HE, MNH, SE, WN, PTH | • | • | • | • | • | • | | \$2.50 |
| 82213 | Screw and Washer ADH, AVH, AT, HE, SE, AVH, MNH, TVH | | | | | | | • | \$0.80 |
| 81696 | Signature Handleset Cap for 818 and 819 CMH, SCE, TVH, VNH | | | • | • | • | • | | \$2.50 |
| 83004 | Signature Series Handleset Screw and Washer for ADH, AVH, CMH, PTH, SCE, VNH | | | | | | | • | \$0.80 |
| 84307 | Screw & Washer for AUH and MNH | | | | | | | • | \$0.80 |
| 88322 | Sex Nut Set & Wood Screw (CE, AMD, BW, DA, AN) | • | • | • | • | • | | | \$6.40 |

NOTES:

*If 15 or 15A not available, 515 (Gray Chromate) is the default finish

| Deadbolts | Model | Function | Finishes | | | | | | List Price | |
|-----------|--------|---|----------|---|--------|--------|---------|-----|------------|---------|
| | | | 3 | 5 | 15/15A | 26/26D | 690/11P | 514 | | NA |
| | 86171 | 660 Deadbolt Screw Pack | • | • | • | • | • | • | | \$1.60 |
| | 86099 | 665 Deadbolt Screw Pack | • | • | • | • | • | • | | \$2.50 |
| | 86073 | One-Way Screws, 665 Deadbolt | • | • | • | • | • | | | \$1.50 |
| | 81247 | P&T and SMT 780/782/980/982 Deadbolt Screw Pack | • | • | • | • | • | • | | \$5.10 |
| | 81251 | 980 Series Deadbolt, Turnpiece Screw & Wrench | | | | | | | • | \$5.10 |
| | 83474 | P&T and SMT 784, 785, 984, 985, Deadbolt Screw Pack | • | • | • | • | • | • | | \$11.00 |
| | 820285 | P&T and SMT 158 Deadbolt Screw Pack | | | • | • | • | • | | \$5.10 |
| | 820286 | P&T and SMT 159 Deadbolt Screw Pack | | | • | • | • | • | | \$11.00 |
| | 83015 | Standard Screw Pack for 258 Series Deadbolt | • | | • | • | | • | | \$6.30 |
| | 83017 | Thin Door Screw Pack for 258 Series Deadbolt | | | • | • | | • | | \$6.30 |

| Dummy/In-Active | Model | Function | Finishes | | | | | | List Price | |
|-----------------|-------|---------------------------------|----------|---|--------|--------|---------|-----|------------|--------|
| | | | 3 | 5 | 15/15A | 26/26D | 690/11P | 514 | | NA |
| | 81708 | 488 & 788 Dummy Mounting Screws | • | • | • | • | • | | | \$1.30 |
| | 81892 | 488 Dummy Adapter | • | • | • | • | • | | | \$6.40 |

| Latch | Model | Function | Finishes | | | | | | List Price | |
|-------|-------|------------------------|----------|---|--------|--------|---------|-----|------------|--------|
| | | | 3 | 5 | 15/15A | 26/26D | 690/11P | 514 | | NA |
| | 81711 | Latch & Strike Screws | • | • | • | • | • | | | \$0.80 |
| | 82893 | 3846 Strike Screw Pack | • | • | • | • | • | | | \$3.40 |

Adjustable Interconnect

| | Model | Function | Finish | | | | | | List Price | |
|--|-------|--|--------|---|--------|--------|---------|-----|------------|--------|
| | | | 3 | 5 | 15/15A | 26/26D | 690/11P | 514 | | NA |
| | 83269 | Adjustable Interconnect Screw Pack | • | • | • | • | • | | | \$3.30 |
| | 83270 | Adjustable interconnect Screw Pack (Thick Door Pack) | • | • | • | • | • | | | \$3.30 |

Strike Screws

| | Model | Function | Finish | | | | | | List Price | |
|--|-------|--------------------------|--------|---|--------|--------|---------|-----|------------|--------|
| | | | 3 | 5 | 15/15A | 26/26D | 690/11P | 514 | | NA |
| | 86356 | 3" Strike Screws | • | • | • | • | • | | | \$3.30 |
| | 88604 | Full Round Strike Screws | | | | • | | | | \$3.30 |

Thick Door Conversion

| | Model | Function | Finish | | | | | | List Price | |
|--|-------|---|--------|---|--------|--------|---------|-----|------------|--------|
| | | | 3 | 5 | 15/15A | 26/26D | 690/11P | 514 | | NA |
| | 81691 | P&T and SMT 780/782/980/982 Deadbolt and 913/914/915/916/919 Thick Door Pack | | | | | | | • | \$6.00 |
| | 83022 | 258 Series Deadbolt Thick Door Pack | • | | • | • | | | • | \$6.00 |
| | 81249 | P&T and SMT 784/785/985 Deadbolt Thick Door Kit with 2-11/16" Screws | | | | | | • | | \$6.00 |
| | 84221 | P&T Deadbolt Thick Door Kit with 3.625" Screws | | | | | | • | • | \$6.00 |
| | 86129 | 660 Thick Door Pack | | | | | | | • | \$6.00 |
| | 86130 | 665 Thick Door Pack | • | • | • | • | | | | \$6.00 |
| | 81714 | Thick Door Pack, Signature Series Knobs Concealed Screws Styles | • | • | • | • | • | | | \$6.00 |
| | 81706 | Thick Door Pack, Kwikset and Signatures Knobs & Lever Styles: A, CA, CN, PE, H, AO, CV, P, T, BL, DL, DNL, LRL, ADL, AUL, AVL, CHL, L, LL, TNL, PML | | | | | | | • | \$6.00 |
| | 81838 | Thick Door Pack, Handleset Adapter | • | • | • | • | | | | \$3.30 |

Thick Door

Conversion (cont)

| | Model | Function | Finish | | | | | List Price | |
|--|--------|---|--------|---|--------|--------|---------|------------|--------|
| | | | 3 | 5 | 15/15A | 26/26D | 690/11P | | 514 |
| | 81780 | Thick Door Pack, All Active & Dummy Handsets | • | • | • | • | • | | \$6.00 |
| | 820291 | Thick Door Pack for 154 and 155 Function for the Kwikset Signature Series Lever. No Thick Door Kit is available for the 156 function. | • | • | • | • | • | | \$6.00 |
| | 820289 | P&T and SMT 158 Deadbolt Thick Door Pack | | | • | • | • | | \$6.00 |
| | 820290 | P&T and SMT 159 Deadbolt Thick Door Pack | | | • | • | • | | \$6.00 |
| | 84988 | 1.37" Torque Blade Double Cylinder Thick Door | | | • | • | • | | \$1.90 |
| | 84992 | 2.491" Torque Blade Single Cylinder Thick Door | | | | | | • | \$1.90 |
| | 84994 | 1.40" Torque Blade Thick Door | | | | | | • | \$1.90 |
| | 81861 | Thick Door Screw and Washer | | | | | | • | \$1.40 |
| | 81402 | 800 Handleset Thick Door Spindle | | | | | | • | \$2.00 |

| | | | Hawthorne, Shelburne, Tavaris | Ashfield, Avalon | Austin | Arlington, Chelsea | San Clemente, Vancouver, Prescott Prague | Amador, Bellevue, Dakota |
|-------|----------|--|-------------------------------------|---------------------|--------|-----------------------|--|--------------------------------|
| Model | Function | | | | | | | |
| | 81691 | 980 Deadbolt Thick Door Pack (H16) | X | X | X | X | | |
| | 83022 | 258 Deadbolt Thick Door Pack (H16) | | | | | X | |
| | 86129 | 660 Deadbolt Thick Door Pack (H17) | | | | | | X |
| | 81402 | Handleset Thick Door Spindle (H18) | X | X | X | X | X | X |
| | 81780 | Thick Door Pack for all Handlesets (H17) | X | X | X | X | X | X |
| | 82213 | Throughbolt Screw & Washer (H14) | O | | | | | |
| | 81861 | Thick Door Screw & Washer (H17) | | X | O | | X | |
| | 84307 | Throughbolt Screw & Washer (H14) | | | | | | |
| | 88322 | Sex Nut & Wood Screw Set (H14) | | | | X | | X |

X: Needed for thick door option









O: Optional - Part comes with product on standard order

Must specify finish on order

| Misc. Parts | Model | Function | Finish | | | | | | | | List Price | | |
|-------------|-------|--------------------------------|--------|---|----|-----|----|-----|---------|-----|------------|----|---------|
| | | | 3 | 5 | 15 | 15A | 26 | 26D | 690/11p | 514 | | NA | |
| | 82768 | 660/665 Cylinder Guard | | | | | | | | | | • | \$4.10 |
| | 87760 | 780 Exterior Cylinder Guard | | | | | | | | | | • | \$4.30 |
| | 82746 | 660/665 Cylinder Guard Cover | • | • | • | • | • | • | • | • | | | \$5.30 |
| | 87759 | 780 Cylinder Guard Cover | • | • | • | • | • | • | • | • | | | \$9.90 |
| | 82216 | 980 Cylinder Guard Cover | • | • | • | • | • | • | • | • | | | \$9.90 |
| | 84991 | 660 Torque Blade | | | | | | | | | | • | \$2.10 |
| | 83273 | 660/663/667/677/588 Thumb Turn | • | • | • | • | • | • | • | • | | | \$8.50 |
| | 81692 | 780 Thumb Turn | • | • | • | • | • | • | • | • | | | \$24.30 |
| | 82217 | 980 Thumb Turn | • | • | • | • | • | • | • | • | | | \$24.30 |
| | 88381 | 664, 667, 677 Exterior Plate | • | • | | | | • | • | • | | | \$19.70 |
| | 81295 | Kwik-Install Mounting Plate | | | | | | | | | | • | \$3.40 |
| | 87789 | Deadbolt Reinforcing Plate | | | | | | | | | | • | \$1.70 |
| | 82778 | 699 Function Dummy Cylinder | • | • | • | • | • | • | • | • | | | \$5.50 |
| | 81239 | Grade 1 Body Dummy Cylinder | | | | | | | | | | • | \$12.70 |
| | 85184 | Dummy Deadbolt Cylinder Plug | | | • | | | • | • | • | • | | \$3.70 |
| | 83162 | U.L. Shield Entry - Halifax | | | | | | | | | | • | \$6.30 |
| | 83163 | U.L. Shield Passage - Halifax | | | | | | | | | | • | \$6.30 |
| | 83164 | U.L. Cotter Pin | | | | | | | | | | • | \$0.20 |

| Misc. Parts | Model | Function | Finish | | | | | | | List Price | |
|---|------------|-------------------------------------|--------|---|----|-----|----|-----|---------|------------|---------|
| | | | 3 | 5 | 15 | 15A | 26 | 26D | 690/11p | | NA |
|  | 81226 | Dummy Cylinder Cover | • | • | • | • | • | • | • | | \$3.70 |
|  | 84990 | 663/667/677/664 Tailpiece | | | | | | | | • | \$2.10 |
|  | 84568 | 663 Block, Bolt Mounting | | | | | | | | • | \$1.30 |
|  | 81404 | Non-Handed Levers Dummy Adapter | | | | | | | | • | \$12.50 |
|  | 88841 | 300 Knobs Interior Round Spindle | | | | | | | | • | \$0.70 |
|  | 87628 | 740 Interior Round Spindle | | | | | | | | • | \$1.20 |
|  | 85624 | 3-1/2" Screw Driver Bit (10 Pack) | | | | | | | | • | \$54.90 |
|  | 88448 | U.L. Shield Knobs | | | | | | | | • | \$6.30 |
|  | 81857 | U.L. Shield Deadbolts | | | | | | | | • | \$6.10 |
|  | 81822 | DB 2-1/8" Adapter for 780/970/980 | | | | | | | | • | \$3.40 |
|  | 84987 | .835" Torque Blade | | | | | | | | • | \$2.00 |
|  | 84993 | 1.097" Torque Blade, Standard Door | | | | | | | | • | \$17.50 |
|  | 83621 | Finish Sample Ring | | | | | | | | • | \$3.90 |
|  | 83024 | 258 Series Mounting Plate | | | | | | | | • | \$3.90 |
|  | 85333 | Half Round & Round Spindle Assembly | | | | | | | | • | \$4.60 |
|  | 85570 | 5570-07 Screw #8-32 x 1-1/2 | | | • | | | | | | \$0.10 |
|  | 820314 | Levers and Knobs Frost Insert | | | | | | | | • | \$7.60 |
|  | 800004-349 | Handleset Mechanism | | | | | | | | • | \$13.10 |
|  | 820318-001 | Deadbolt Frost Insert | | | | | | | | • | \$11.80 |

| Misc. Parts | Model | Function | Finish | | | | | | | List Price |
|-------------|-------|---|--------|---|----|-----|----|---------|----|------------|
| | | | L03 | 5 | 15 | 15A | 26 | 11P/514 | NA | |
| | 83306 | 909 TRL Top Cover | • | | • | | | | • | \$12.60 |
| | 80435 | 909 Interior Cover Screws | | | • | | | | | \$1.00 |
| | 83307 | 909, 912 Top Battery Holder | | | | | | | • | \$1.90 |
| | 83581 | 913, 915, 916, 919 and 953 Top Battery Holder (For use with: 83580) | | | | | | | • | \$1.90 |
| | 85137 | Interior Mounting Plate: 913, 915, 916, 919, 938, 939, 942, 953, 954, 959 | | | | | | | • | \$5.45 |
| | 83583 | Electronics Deadbolt Adapter Ring | | | | | | | • | \$3.05 |
| | 83585 | Interior Cover Screws: 913, 915, 916, 919, 938, 939, 942, 953, 954, 959 | • | | • | | | | • | \$1.15 |
| | 83651 | 953, 954 Mounting Screws for 1-3/8" Door Thickness | | | | | | | • | \$5.50 |
| | 83653 | 2" Thick Door Kit for 953, 938, 939, 959 | | | | | | | • | \$5.35 |
| | 83033 | 2 1/4" Thick Door Kit for 953, 938, 939, 959 | | | | | | | | |
| | 83502 | Battery Pack with Pull Tab (For use with: Interior Covers 83813 / 83814) | | | | | | | • | \$1.90 |
| | 85143 | 917 HFL Interior Battery Cover | | | | | | | • | \$4.50 |
| | 85144 | 917 Mounting Screws with Spindle | | | • | | • | • | | \$6.00 |
| | 85145 | 917, 955 TNL Interior Battery Cover | | | | | | | • | \$4.50 |
| | 83813 | Interior Cover, TRL (For use with: Battery Pack with Pull Tab 83502) | | | | | | | • | \$32.10 |
| | 83814 | Interior Cover, CNT (For use with: Battery Pack with Pull Tab 83502) | | | | | | | • | \$32.10 |
| | 85196 | Security Screw for black interior RF Window | | | | | | | • | \$0.50 |

| Misc. Parts | Model | Function | Finish | | | | | | | List Price | |
|---|-------|---------------------------------------|--------|---|----|-----|----|---------|-----|------------|----------|
| | | | 3/L03 | 5 | 15 | 15A | 26 | 11P/514 | 690 | | NA |
|  | 85133 | 938 Halo Exterior Keypad | | | • | | | • | | | \$57.56 |
|  | 85134 | 939 Halo Exterior Touchscreen | | | • | | • | • | | | \$113.01 |
|  | 85135 | 942 Aura Exterior Keypad | | | • | | | • | | | \$49.70 |
|  | 85138 | 938 Halo Keypad Interior Chassis | | | | | | | | • | \$180.57 |
|  | 85139 | 939 Halo Touchscreen Interior Chassis | | | | | | | | • | \$179.54 |
|  | 85140 | 942 Aura Keypad Interior Chassis | | | | | | | | • | \$118.30 |
|  | 85141 | Interior Cover, 15: 938, 939, 942 | | | • | | • | • | | | \$32.10 |
|  | 83187 | Tapered Deadbolt, RC, 2-Way | • | | • | | | • | • | | \$5.00 |