

✍ Checklist ✍

Your price book should contain the following dated pages. If any pages are missing, return this list with the missing items circled and we will forward them to you.

GENERAL INFORMATION

GI-1 May 1, 2021
 GI-2 May 1, 2021
 GI-3 May 1, 2021
 GI-4 May 1, 2021
 GI-5 May 1, 2021
 GI-6 May 1, 2021
 GI-7 May 1, 2021
 GI-8 May 1, 2021
 GI-9 May 1, 2021
 GI-10 May 1, 2021
 GI-11 May 1, 2021
 GI-12 May 1, 2021
 GI-13 May 1, 2021
 GI-14 May 1, 2021
 GI-15 May 1, 2021
 GI-16 May 1, 2021
 GI-17 May 1, 2021
 GI-18 May 1, 2021
 GI-19 May 1, 2021
 GI-20 May 1, 2021
 GI-21 May 1, 2021
 GI-22 May 1, 2021
 GI-23 May 1, 2021
 GI-24 May 1, 2021
 GI-25 May 1, 2021
 GI-26 May 1, 2021
 GI-27 May 1, 2021
 GI-28 May 1, 2021
 GI-29 May 1, 2021
 GI-30 May 1, 2021
 GI-31 May 1, 2021
 GI-32 May 1, 2021
 GI-33 May 1, 2021
 GI-34 May 1, 2021
 GI-35 May 1, 2021
 GI-36 May 1, 2021
 GI-37 May 1, 2021
 GI-38 May 1, 2021
 GI-39 May 1, 2021

CYLINDERS & KEYING

CK-1 May 1, 2021
 CK-2 May 1, 2021
 CK-3 May 1, 2021
 CK-4 May 1, 2021
 CK-5 May 1, 2021
 CK-6 May 1, 2021
 CK-7 May 1, 2021
 CK-8 May 1, 2021

CK-9 May 1, 2021
 CK-10 May 1, 2021
 CK-11 May 1, 2021
 CK-12 May 1, 2021
 CK-13 May 1, 2021
 CK-14 May 1, 2021
 CK-15 May 1, 2021
 CK-16 May 1, 2021
 CK-17 May 1, 2021
 CK-18 May 1, 2021
 CK-19 May 1, 2021
 CK-20 May 1, 2021
 CK-21 May 1, 2021
 CK-22 May 1, 2021
 CK-23 May 1, 2021
 CK-24 May 1, 2021
 CK-25 May 1, 2021
 CK-26 May 1, 2021
 CK-27 May 1, 2021
 CK-28 May 1, 2021
 CK-29 May 1, 2021
 CK-30 May 1, 2021
 CK-31 May 1, 2021
 CK-32 May 1, 2021
 CK-33 May 1, 2021
 CK-34 May 1, 2021
 CK-35 May 1, 2021
 CK-36 May 1, 2021
 CK-37 May 1, 2021
 CK-38 May 1, 2021

BORED LOCKS

BL-1 May 1, 2021
 BL-2 May 1, 2021
 BL-3 May 1, 2021
 BL-4 May 1, 2021
 BL-5 May 1, 2021
 BL-6 May 1, 2021
 BL-7 May 1, 2021
 BL-8 May 1, 2021
 BL-9 May 1, 2021

MORTISE LOCKS

BL-10 May 1, 2021
 BL-11 May 1, 2021
 BL-12 May 1, 2021
 BL-13 May 1, 2021
 BL-14 May 1, 2021
 BL-15 May 1, 2021
 BL-16 May 1, 2021
 BL-17 May 1, 2021
 BL-18 May 1, 2021

BL-19 May 1, 2021
 BL-20 May 1, 2021
 BL-21 May 1, 2021
 BL-22 May 1, 2021
 BL-23 May 1, 2021
 BL-24 May 1, 2021
 BL-25 May 1, 2021
 BL-26 May 1, 2021
 BL-27 May 1, 2021
 BL-28 May 1, 2021
 BL-29 May 1, 2021
 BL-30 May 1, 2021
 BL-31 May 1, 2021
 BL-32 May 1, 2021
 BL-33 May 1, 2021
 BL-34 May 1, 2021
 BL-35 May 1, 2021
 BL-36 May 1, 2021
 BL-37 May 1, 2021
 BL-38 May 1, 2021
 BL-39 May 1, 2021
 BL-40 May 1, 2021
 BL-41 May 1, 2021
 BL-42 May 1, 2021
 BL-43 May 1, 2021
 BL-44 May 1, 2021
 BL-45 May 1, 2021
 BL-46 May 1, 2021
 BL-47 May 1, 2021
 BL-48 May 1, 2021
 BL-49 May 1, 2021
 BL-50 May 1, 2021
 BL-51 May 1, 2021
 BL-52 May 1, 2021
 BL-53 May 1, 2021
 BL-54 May 1, 2021
 BL-55 May 1, 2021
 BL-56 May 1, 2021
 BL-57 May 1, 2021

MORTISE LOCKS

ML-1 May 1, 2021
 ML-2 May 1, 2021
 ML-3 May 1, 2021
 ML-4 May 1, 2021
 ML-5 May 1, 2021
 ML-6 May 1, 2021
 ML-7 May 1, 2021
 ML-8 May 1, 2021
 ML-9 May 1, 2021

ML-10 May 1, 2021
 ML-11 May 1, 2021
 ML-12 May 1, 2021
 ML-13 May 1, 2021
 ML-14 May 1, 2021
 ML-15 May 1, 2021
 ML-16 May 1, 2021
 ML-17 May 1, 2021
 ML-18 May 1, 2021
 ML-19 May 1, 2021
 ML-20 May 1, 2021
 ML-21 May 1, 2021
 ML-22 May 1, 2021
 ML-23 May 1, 2021
 ML-24 May 1, 2021
 ML-25 May 1, 2021
 ML-26 May 1, 2021
 ML-27 May 1, 2021
 ML-28 May 1, 2021
 ML-29 May 1, 2021
 ML-30 May 1, 2021
 ML-31 May 1, 2021
 ML-32 May 1, 2021
 ML-33 May 1, 2021
 ML-34 May 1, 2021
 ML-35 May 1, 2021
 ML-36 May 1, 2021
 ML-37 May 1, 2021
 ML-38 May 1, 2021
 ML-39 May 1, 2021
 ML-40 May 1, 2021
 ML-41 May 1, 2021
 ML-42 May 1, 2021
 ML-43 May 1, 2021
 ML-44 May 1, 2021
 ML-45 May 1, 2021
 ML-46 May 1, 2021
 ML-47 May 1, 2021
 ML-48 May 1, 2021
 ML-49 May 1, 2021
 ML-50 May 1, 2021
 ML-51 May 1, 2021
 ML-52 May 1, 2021
 ML-53 May 1, 2021
 ML-54 May 1, 2021
 ML-55 May 1, 2021
 ML-56 May 1, 2021
 ML-57 May 1, 2021
 ML-58 May 1, 2021

ML-59 May 1, 2021
 ML-60 May 1, 2021
 ML-61 May 1, 2021
 ML-62 May 1, 2021
 ML-63 May 1, 2021
 ML-64 May 1, 2021
 ML-65 May 1, 2021
 ML-66 May 1, 2021
 ML-67 May 1, 2021
 ML-68 May 1, 2021
 ML-69 May 1, 2021
 ML-70 May 1, 2021
 ML-71 May 1, 2021
 ML-72 May 1, 2021
 ML-73 May 1, 2021
 ML-74 May 1, 2021
 ML-75 May 1, 2021
 ML-76 May 1, 2021
 ML-77 May 1, 2021
 ML-78 May 1, 2021
 ML-79 May 1, 2021
 ML-80 May 1, 2021
 ML-81 May 1, 2021
 ML-82 May 1, 2021
 ML-83 May 1, 2021
 ML-84 May 1, 2021
 ML-85 May 1, 2021
 ML-86 May 1, 2021
 ML-87 May 1, 2021
 ML-88 May 1, 2021
 ML-89 May 1, 2021
 ML-90 May 1, 2021
 ML-91 May 1, 2021
 ML-92 May 1, 2021
 ML-93 May 1, 2021
 ML-94 May 1, 2021
 ML-95 May 1, 2021
 ML-96 May 1, 2021
 ML-97 May 1, 2021
 ML-98 May 1, 2021
 ML-99 May 1, 2021
 ML-100 May 1, 2021
 ML-101 May 1, 2021
 ML-102 May 1, 2021
 ML-103 May 1, 2021
 ML-104 May 1, 2021
 ML-105 May 1, 2021
 ML-106 May 1, 2021
 ML-107 May 1, 2021

COMPANY NAME: _____

ADDRESS: _____

ATTN: _____

Checklist

Your price book should contain the following dated pages. If any pages are missing, return this list with the missing items circled and we will forward them to you.

ML-108	May 1, 2021	ML-157	May 1, 2021	DC-2	May 1, 2021	ED-37	May 1, 2021	SP-4	May 1, 2021
ML-109	May 1, 2021	ML-158	May 1, 2021	DC-3	May 1, 2021	ED-38	May 1, 2021	SP-5	May 1, 2021
ML-110	May 1, 2021	ML-159	May 1, 2021	DC-4	May 1, 2021	ED-39	May 1, 2021	SP-6	May 1, 2021
ML-111	May 1, 2021	ML-160	May 1, 2021	DC-5	May 1, 2021	ED-40	May 1, 2021	SP-7	May 1, 2021
ML-112	May 1, 2021	ML-161	May 1, 2021	DC-6	May 1, 2021	ED-41	May 1, 2021	SP-8	May 1, 2021
ML-113	May 1, 2021	ML-162	May 1, 2021	DC-7	May 1, 2021	ED-42	May 1, 2021	SP-9	May 1, 2021
ML-114	May 1, 2021	ML-163	May 1, 2021	DC-8	May 1, 2021	ED-43	May 1, 2021	SP-10	May 1, 2021
ML-115	May 1, 2021	ML-164	May 1, 2021	DC-9	May 1, 2021	ED-44	May 1, 2021	SP-11	May 1, 2021
ML-116	May 1, 2021	ML-165	May 1, 2021	DC-10	May 1, 2021	ED-45	May 1, 2021	SP-12	May 1, 2021
ML-117	May 1, 2021	ML-166	May 1, 2021	HS-1	May 1, 2021	ED-46	May 1, 2021	SP-13	May 1, 2021
ML-118	May 1, 2021	ML-167	May 1, 2021	HS-2	May 1, 2021	ED-47	May 1, 2021	SP-14	May 1, 2021
ML-119	May 1, 2021	ML-168	May 1, 2021			ED-48	May 1, 2021		
ML-120	May 1, 2021	ML-169	May 1, 2021	EXIT DEVICES		ED-49	May 1, 2021	ELECTRICAL	
ML-121	May 1, 2021	ML-170	May 1, 2021	ED-1	May 1, 2021	ED-50	May 1, 2021	EL-1	May 1, 2021
ML-122	May 1, 2021	ML-171	May 1, 2021	ED-2	May 1, 2021	ED-51	May 1, 2021	EL-2	May 1, 2021
ML-123	May 1, 2021	ML-172	May 1, 2021	ED-3	May 1, 2021	ED-52	May 1, 2021	EL-3	May 1, 2021
ML-124	May 1, 2021	ML-173	May 1, 2021	ED-4	May 1, 2021	ED-53	May 1, 2021	EL-4	May 1, 2021
ML-125	May 1, 2021	ML-174	May 1, 2021	ED-5	May 1, 2021	ED-54	May 1, 2021	EL-5	May 1, 2021
ML-126	May 1, 2021	ML-175	May 1, 2021	ED-6	May 1, 2021	ED-55	May 1, 2021	EL-6	May 1, 2021
ML-127	May 1, 2021			ED-7	May 1, 2021	ED-56	May 1, 2021	EL-7	May 1, 2021
ML-128	May 1, 2021	MULTI-POINT		ED-8	May 1, 2021	ED-57	May 1, 2021	EL-8	May 1, 2021
ML-129	May 1, 2021	LOCKING HARDWARE		ED-9	May 1, 2021	ED-58	May 1, 2021	EL-9	May 1, 2021
ML-130	May 1, 2021	MP-1	May 1, 2021	ED-10	May 1, 2021	ED-59	May 1, 2021	EL-10	May 1, 2021
ML-131	May 1, 2021	MP-2	May 1, 2021	ED-11	May 1, 2021	ED-60	May 1, 2021	EL-11	May 1, 2021
ML-132	May 1, 2021	MP-3	May 1, 2021	ED-12	May 1, 2021	ED-61	May 1, 2021	EL-12	May 1, 2021
ML-133	May 1, 2021	MP-4	May 1, 2021	ED-13	May 1, 2021	ED-62	May 1, 2021		
ML-134	May 1, 2021	MP-5	May 1, 2021	ED-14	May 1, 2021	ED-63	May 1, 2021	PROFILE SERIES	
ML-135	May 1, 2021	MP-6	May 1, 2021	ED-15	May 1, 2021	ED-64	May 1, 2021	PS-1	May 1, 2021
ML-136	May 1, 2021	MP-7	May 1, 2021	ED-16	May 1, 2021	ED-65	May 1, 2021	PS-2	May 1, 2021
ML-137	May 1, 2021	MP-8	May 1, 2021	ED-17	May 1, 2021	ED-66	May 1, 2021	PS-3	May 1, 2021
ML-138	May 1, 2021	MP-9	May 1, 2021	ED-18	May 1, 2021	ED-67	May 1, 2021	PS-4	May 1, 2021
ML-139	May 1, 2021	MP-10	May 1, 2021	ED-19	May 1, 2021	ED-68	May 1, 2021	PS-5	May 1, 2021
ML-140	May 1, 2021	MP-11	May 1, 2021	ED-20	May 1, 2021	ED-69	May 1, 2021	PS-6	May 1, 2021
ML-141	May 1, 2021	MP-12	May 1, 2021	ED-21	May 1, 2021	ED-70	May 1, 2021	PS-7	May 1, 2021
ML-142	May 1, 2021	MP-13	May 1, 2021	ED-22	May 1, 2021			PS-8	May 1, 2021
ML-143	May 1, 2021	MP-14	May 1, 2021	ED-23	May 1, 2021	AUXILIARY LOCKS		PS-9	May 1, 2021
ML-144	May 1, 2021	MP-15	May 1, 2021	ED-24	May 1, 2021	AL-1	May 1, 2021	PS-10	May 1, 2021
ML-145	May 1, 2021	MP-16	May 1, 2021	ED-25	May 1, 2021	AL-2	May 1, 2021	PS-11	May 1, 2021
ML-146	May 1, 2021	MP-17	May 1, 2021	ED-26	May 1, 2021	AL-3	May 1, 2021	PS-12	May 1, 2021
ML-147	May 1, 2021	MP-18	May 1, 2021	ED-27	May 1, 2021	AL-4	May 1, 2021	PS-13	May 1, 2021
ML-148	May 1, 2021	MP-19	May 1, 2021	ED-28	May 1, 2021	AL-5	May 1, 2021	PS-14	May 1, 2021
ML-149	May 1, 2021	MP-20	May 1, 2021	ED-29	May 1, 2021	AL-6	May 1, 2021	PS-15	May 1, 2021
ML-150	May 1, 2021	MP-21	May 1, 2021	ED-30	May 1, 2021	AL-7	May 1, 2021	PS-16	May 1, 2021
ML-151	May 1, 2021	MP-22	May 1, 2021	ED-31	May 1, 2021	AL-8	May 1, 2021		
ML-152	May 1, 2021	MP-23	May 1, 2021	ED-32	May 1, 2021				
ML-153	May 1, 2021			ED-33	May 1, 2021	SPECIALTY HARDWARE			
ML-154	May 1, 2021	DOOR CLOSERS/		ED-34	May 1, 2021	SP-1	May 1, 2021		
ML-155	May 1, 2021	HOLDERS & STOPS		ED-35	May 1, 2021	SP-2	May 1, 2021		
ML-156	May 1, 2021	DC-1	May 1, 2021	ED-36	May 1, 2021	SP-3	May 1, 2021		

COMPANY NAME: _____

ADDRESS: _____

ATTN: _____

SARGENT®

ASSA ABLOY

Price Book No. 35

USA & Canada Prices Effective May 1, 2021

*THIS PRICE BOOK SUPERSEDES AND TAKES
PRECEDENCE OVER ANY OF OUR PRODUCT
CATALOGS IN TERMS OF PRODUCT AVAILABILITY.*

*CONTACT SARGENT MANUFACTURING CO. FOR PRICES AND
AVAILABILITY OF NON-STANDARD AND SPECIAL ITEMS NOT
LISTED IN THIS PRICE BOOK*

General Information

USA Terms & Conditions	GI-1 - GI-5
USA RGA Policy	GI-4
USA Product Modification	GI-5
Partner Services in Canada	GI-6
Limited Warranty	GI-7 - GI-8
Finishes	GI-9
Merchandising Aids	GI-10 - GI-11
Weight Charge - Screw Substitutions	GI-12
Master Prefix Listing	GI-13 - GI-17
Business Hours & Holiday Schedule	GI-18
Who's Who at Sargent	GI-19 - GI-22
Ordering Tips	GI-23 - GI-25
Order Forms	GI-26 - GI-40

Cylinders & Keying

How to Order / Key Control Types	CK-1
Keying Charges	CK-2 - CK-3
Key Charts, Key Wizard Software	CK-4
Mortise, Rim Cylinders & Parts	CK-5
Rings, Turn Knobs & Mail Box Cylinders	CK-6
Cylindrical Lock Cylinders & Parts	CK-7
SARGENT XC Series Cylinders	CK-8 - CK-9
SARGENT Large Format Interchangeable Core Cylinders & Old Style Removable Core Cylinders	CK-10
SARGENT XC - Large Format IC Core Cylinders	CK-11
Small Format Interchangeable Core	CK-12
XC - Small Format Interchangeable Core	CK-13
Keying Kits, Tools, Gauges, Components	CK-14
Keyblanks	CK-15 - CK-16
SARGENT Cut Keys/Competitor Keyways	CK-17
KESO F1 Security System	CK-18 - CK-22
KESO System	CK-23 - CK-27
Signature Key System	CK-28 - CK-31
Degree Key System	CK-32 - CK-38

Bored Locks

How to Order / ANSI Finish & Function Comparison	BL-1
T-Zone (11 Line)	BL-2 - BL-15
10X Line	BL-16 - BL-21
10-Line	BL-22 - BL-33
7 Line	BL-34 - BL-41
6500 Line	BL-42
DL Series	BL-43 - BL-45
RDL Series	BL-44 - BL-51
8X Line	BL-52 - BL-53
6 Line	BL-54 - BL-57

Mortise Locks 7800/8200

How to Order / ANSI Finish & Function Comparison	ML-1
8200 Line (levers)	ML-2 - ML-75
7800 Line (Knobs)	ML-80 - ML-89
8200 Deadlocks	ML-90
Distributor Bulk Pack Trim Program	ML-91 - ML-92
7800/8200 Lockbodies	ML-92
7800/8200 Working Trim Sets	ML-96 - ML-107
7800/8200 Assemblies & Parts	ML-108 - ML-120
How to Order / ANSI Finish & Function Comparison	ML-121
7900 Mortise Lock	ML-122 - ML-154

High Security Mortise Lock 9200

How to Order - ANSI Finish & Function Comparison	ML-155
9200 & M9200 - Levers	ML-156 - ML-163
9200 & M9200 - Knobs	ML-164 - ML-169
9200 BHW	ML-170 - ML-173
9200 Deadlock, Lockbodies	ML-174
9200 Parts	ML-175
9200 Inside Trim Set	ML-176
9200 Outside Trim Set	ML-177

Multipoint Locking Hardware

How to Order - ANSI Finish & Function Comparison	MP-1
7000 Series	MP-2 - MP-3
AD7000 Series	MP-4 - MP-5
WD7000 Series	MP-6 - MP-7
ER/ES/ET Lever Control Trim	MP-8 - MP-9
7000 Strikes, Locking Slide & Spindle Kits	MP-10
Parts	MP-11
FM6100 Series	MP-12 - MP-13
FM7300 Series	MP-14 - MP-23

Door Closers/holders & Stops

How to Order / ANSI Finish & Function Comparison	DC-1
Additional Features	DC-2
1431 / 281 / 351 Series	DC-3
268, 269, 281 Security Package Closer	DC-4
422 Cam Action Door Closer	DC-4
268, 269, 278 Concealed Closers	DC-4
Finish Options	DC-5
Arms & Accessories	DC-6
Bodies/Covers/Retrofit Kits	DC-7
1331 / 1131 Series	DC-8
Parts	DC-9 - DC-10
Overhead Holders & Stops	HS-1
Electromagnetic Holders & Stops	HS-2

Exit Devices

How to Order - ANSI Finish & Function Comparison	ED-1
20 Series	ED-2 - ED-3
30 Series	ED-4 - ED-5
9898 Reversible Stocking Exit	ED-6 - ED-7
80 Series	ED-8 - ED-37
9400 Series	ED-38 - ED-39
90 Series	ED-40 - ED-45
Trim	ED-46 - ED-49
8893/8895 Inactive & Active Push Bars	ED-50 - ED-51
Mullions & Accessories	ED-52 - ED-56
Parts	ED-57 - ED-70

Auxiliary Locks

470 SSL1 Series	AL-1
480 Series	AL-2
4870 Series	AL-3
460-480-4870 Strikes & Parts	AL-4
4870 Parts	AL-5
Locker, Utility, & Cabinet Locks	AL-6
758 Padlock & Parts	AL-7
858 Padlock & Parts	AL-8

TOC-2

TABLE OF CONTENTS



USA & Canada Prices Effective May 1, 2021

Healthcare Hardware

HP Series Tubular Lock with Push/Pull (ALP)	
Trim & Options	SP-1
114/115 Series with Push/Pull Trim & Options	SP-2
114/115 Push/Pull Parts	SP-3
8200 Series PUSH/PULL Trim (ALP) Options	SP-4
8200 Series PUSH/PULL Trim (ALP)	SP-5
8200 Series BHL Trim Options	SP-6
8200 Series BHL Trim	SP-7
8200 Series BHW Trim Options	SP-8
8200 Series BHW Trim	SP-9
7800 Series Push/Pull Trim(PT) Options	SP-10
7800 Series Push/Pull Trim(PT)	SP-11
7800 Series BHD Trim Options	SP-12
7800 Series BHD Trim	SP-13
7800 Series BHD IS and OS Trim	SP-14

Electrical

Electro-Mechanical Locksets	EL-1
Electro-Mechanical Exits	EL-2
ElectroLynx / Wiring Diagram Service	EL-3
Electronic Accessories	EL-4 - EL-7
Alarm – 5300	EL-8
Fire Guard Door Closers	EL-9 - EL-10
Parts	EL-11 - EL-12

Profile Series - Stand Alone Products

How to Order / ANSI Finish & Function Comparison	PS-1
10 Line Cylindrical Lock - KP, G1, RF	PS-2 - PS-3
8200 Series Mortise Lock - KP, G1, RF	PS-4 - PS-7
80 Series - Exit Device - KP, G1, RF	PS-8 - PS-9
Accessories	PS-10
Parts & Accessories	PS-11
10 Line Parts & Accessories	PS-12
8200 Series Parts & Accessories	PS-13 - PS-14
80 Series Trim & Trim Kits	PS-15
80 Series Parts & Accessories	PS-16

TABLE OF CONTENTS

USA & Canada Prices Effective May 1, 2021

GENERAL INFORMATION

USA Terms and Conditions.....	GI-1
USA Terms and Conditions.....	GI-2
USA Terms and Conditions.....	GI-3
USA Terms and Conditions.....	GI-4
USA Terms and Conditions.....	GI-5
Partner Services in Canada	GI-6
Limited Warranty	GI-7
Limited Warranty	GI-8
Finishes	GI-9
Merchandising Aids.....	GI-10
Merchandising Aids.....	GI-11
Weight Chart - Screw Substitutions	GI-12
Master Option Listing (1-26).....	GI-13
Master Option Listing (28-65737P)	GI-14
Master Option Listing (68-83).....	GI-15
Master Option Listing (84-SC).....	GI-16
Master Option Listing (SE-WS).....	GI-17
Business Hours, Holiday Schedule, Website Information, Partner Services in USA	GI-18
Who's Who at SARGENT	GI-19
Who's Who at SARGENT	GI-20
Who's Who at SARGENT	GI-21
Who's Who at SARGENT	GI-22
Ordering Tips and SARGENT Key Systems Security Policy.....	GI-23
Ordering Tips and Keying Authorization Documentation	GI-24
Ordering Tips.....	GI-25
SARGENT Order Lead Sheet Check List	GI-26

Keying Order Form.....	GI-27
Keying Order Form.....	GI-28
Keying Order Form.....	GI-29
Locksets Order Form	GI-30
Exit Devices Order Form.....	GI-31
Door Closers Order Form.....	GI-32
Miscellaneous Items Order Form	GI-33
Signature Series Order Form	GI-34
KESO Authorized Signature Form	GI-35
KESO Authorization Form.....	GI-36
KESO 24 Hour Key Order Form	GI-37
Degree™ System Information Document	GI-38
Degree™ DG1, DG2, DG3 Required Administrative Documents.....	GI-39

Acceptance

SARGENT® reserves the right to decline an order, in whole or in part, when the type or quantity of goods or credit worthiness of the Purchaser is not satisfactory to us in our sole and absolute discretion.

Purchase Orders, QUOTE requests, Acknowledgements or the like issued by the Purchaser that have contrary standard terms and conditions are not binding on SARGENT®, unless such terms and conditions are approved in a separate written agreement by SARGENT's authorized representatives. In the event of an acceptance of Purchaser's Purchase Order by SARGENT®, the Purchaser agrees that such acceptance is solely conditioned on Purchaser's acceptance of the terms and conditions set forth in this instrument, regardless of the terms and conditions specified in the Purchaser's Purchase order. The terms and conditions in Purchaser's Purchase order which conflict with terms and conditions of this instrument shall be disregarded and are hereby rejected, and this instrument shall constitute the entire agreement between SARGENT® and the Purchaser.

In the event that SARGENT® does not enforce or require strict performance of any term or condition hereof, or of any other document, instrument or other agreement relating to goods sold, such lack of enforcement or requirement of strict performance will not waive, affect or diminish any right of SARGENT® to enforce or require strict performance of such term or condition in the future.

Prices

All prices are subject to change without notice and are not guaranteed. All shipments will be made at prices in effect at the time of order acceptance.

Possession of this price list does not constitute an agreement to sell.

We reserve the right to correct clerical, stenographic and other obvious errors at any time.

Terms:

2% tenth net 30 days after statement date.

It is understood that SARGENT® may impose and charge a finance charge which is the lesser or one and one-half percent (1-1/2%) per month or the highest rate allowed by law on any amount which becomes past due and delinquent. Additionally the Customer shall be responsible for all collection costs, court costs and reasonable attorney's fees (where allowed by law) in connection with the recovery of any delinquent amount.

Freight

All orders are shipped FOB factory/warehouse, except as expressly provided below. When delivered to the Transportation Company, the Purchaser assumes the risk of loss or damage in transit.

Customer orders with net product value in excess of \$12,000.00 will be shipped prepaid by SARGENT's carrier of choice to a single destination point in the United States.

Customer orders with net product value less than \$12,000.00 will be shipped prepaid by SARGENT's carrier of choice and freight and handling charges will be added to the customer's invoice.

A minimum freight and handling charge of \$15 will be charged on orders with net product value of \$400 or less. The minimum freight and handling charge will not apply to orders for only Cut (bitted) keys of any type, Master keys, Master keyed cylinders or padlocks and factory generated bitting lists that do not have any other product types included on the order. Freight on these orders will be charged as the percentage of invoice value.

For orders with net product value greater than \$400 and less than \$12,000, freight charges will be calculated as a percentage of the net invoice value and will be added to Customer's invoice. The percentage is based on the National U.S. Average On Highway Diesel Fuel Prices as reported by the US Department of Energy in effect at the beginning of each quarter. On the first Monday of each quarter, the new rate will be published on the SARGENT and Door Security Solutions extranet and will go into effect on the 2nd Monday of the quarter. Please refer to the Sargent distributor extranet for the rate chart and information on the current freight charge percentage. The percentage in effect at the time of shipment of the order will be charged.

Great Grand Master keys, Grand Master keys, Master keys, Construction Master keys, Control Keys, Lot Day Keys which are shipped separate from customer order for security reasons, on orders with total net product value in excess of \$12,000.00 will be shipped prepaid by SARGENT's carrier of choice. If the total order value is less than \$12,000, the shipping charges will be added to Customer's invoice.

USA TERMS & CONDITIONS

USA & Canada Prices Effective May 1, 2021

If a customer provides their own freight account # or freight collect for the freight charges, SARGENT will apply a handling fee of \$25 to the invoice.

Turbo Orders – Please refer to the TurboShip catalog for program guidelines, including return and cancellation policy.

Expedited shipping options – If the customer requests an expedited method of shipment such as “Next Day Air” the charges will be prepaid by SARGENT and the full rate for the service, as published by the carrier, will be added to the customer’s invoice.

Packing – SARGENT will pack, mark and ship the products according to its standard procedures for shipment, unless the parties agree, in writing, that SARGENT will comply with any special instructions provided by the customer. Special instructions must be submitted, in writing, at time of order placement. Compliance with special instructions may result in an increased price.

Minimum Invoice:

Minimum order value for complete product is \$250 net product value. The minimum order value for parts orders is \$100 net product value. In the event that the net product value does not meet the required net minimum, Sargent may, at its sole discretion (a) apply a minimum order charge, (b) reject the order or (c) waive the minimum requirement provided that the waiver of the requirement for one order shall not constitute a waiver of the requirement for any future orders.

The following products are exempt from this policy: Cut (bitted) keys of any type, Master keys, Master keyed cylinders or padlocks and factory generated bitting lists.

Quotations:

Complete shipment of the order must be accepted by Purchaser within normal shipping lead times.

The QUOTE number must be referenced on the order.

Any invoiced order that has the incorrect discount applied to it and did not have a QUOTE copy attached to the order or the QUOTE number written on the order will have a service fee of \$100.00 net DEDUCTED from any sales credit issued for the difference in discount.

The QUOTE is null and void if the Purchase Order does not include **ALL** product lines listed on the QUOTE or if the quantities for an item covered by the QUOTE deviate by **10%** or more.

With the issuance and acceptance of a QUOTE for the purchase of products, the Purchaser agrees that products so purchased will not be resold or transferred to any Distributor not authorized by SARGENT® to sell its products. This would be inclusive of branches of the quoted Distributor. Failure to abide by this restriction may result in the Distributor’s ineligibility for Price Concession Authorizations, or other actions in SARGENT’s discretion.

SARGENT® and its sales representatives reserve the right, in their sole discretion and for any reason, to refuse a Distributor’s request to quote a price other than SARGENT’s standard list price and regardless of whether SARGENT® or its sales representatives have previously quoted discounted prices to the Distributor on some or all of its orders.

Non-Cataloged Products:

Products not cataloged or listed in this price book will be considered as special products, and will not be manufactured without prior approval from SARGENT®. All non-cataloged goods cannot be changed or cancelled.

A minimum special handling charge of **\$50.00** will be added for non-cataloged product. Any additional labor or material required will be charged accordingly.

Special products require special handling, and therefore standard lead times may not apply. Please consult with your Sales Representative for further details.

Changes / Cancellation of Orders:

Changes or cancellations to an order will result in a charge of costs for material and labor expenses that have been incurred prior to notification from Customer. If products have already been made and or are located in the shipping room, the 45% Change/Cancellation Fee will apply. Handling charges are billed on Customer's original order.

Suspended Line Items:

If a line item is suspended due to insufficient information, we will notify you via "Q" fax. If a response is not received within 5 business days of the fax, the item(s) will be cancelled off the order. A new order will need to be placed for the cancelled item(s).

Add-On Orders to QUOTE:

Any new order requesting special pricing to match an existing QUOTE number, which has already been ordered, will be accepted up to 60 days after the acknowledgement of the original order. All add-on orders must reference the original factory order number and the corresponding QUOTE number to receive the quoted pricing discount. Add-on orders for stock will not be accepted.

Packaging:

Many items are defined as to Case Lot Packaging or Minimum Order. The case lot policy does not apply to hardware to be used on a specific hardware project.

Delivery:

Orders will be acknowledged and given a scheduled delivery date based on estimated manufacturing lead times. Complete information is required to process all orders. Orders with insufficient information for processing (i.e. keying information, door sizes, etc.) may be subject to extended lead times which are relative to the time required in obtaining the necessary information for order processing. Manufacturing lead time will begin once all information is received to process an order. SARGENT® will use reasonable efforts to deliver products as estimated, but makes no guarantee's as to delivery dates.

SARGENT® will not be liable for back charges incurred based on availability of product or as a result of delays in delivery caused by insufficient information required to process an order.

SARGENT® will not be held responsible for delays in delivery caused by strikes, fires, floods or any other causes beyond our control, including the delivery of material to us. Under no circumstances shall SARGENT® be liable or accountable for consequential damages due to failure of delivery.

Claims:

In the event of Company or Customer error, claims for shortages, pricing errors and/or incorrectly filled orders must be submitted in writing to Customer Service within thirty **(30)** days from receipt of material.

Any claims for shortages or damage by the Carrier must be made by the Customer directly to the Carrier.

Limited Carrier insurance is typically offered for all orders. If the Customer requires additional insurance, please contact a SARGENT® Customer Service Representative upon submittal of the order. SARGENT® will obtain requested insurance and the additional cost will be included on Customer's invoice.

Invoice Deduction:

A SARGENT® Sales Representative or Customer Service Representative must be notified of any disputed invoices within sixty **60** days from the date of invoice. Deductions should only be taken for the disputed amount and the balance of the invoice is due and payable within standard payment terms.

USA TERMS & CONDITIONS

USA & Canada Prices Effective May 1, 2021

Returned Goods:

It is the policy of SARGENT® to **not** accept returns of any materials that are correctly furnished as per the Distributor's Purchase Order. Return of product due to customer order error or accommodation must be pre-arranged with SARGENT® and approved in writing by Sales Management.

No Returns Accepted for the following: 10B Finished products, KESO, Signature, Degree, Keyed Cylinders, Specials, Anything Used, Discontinued, Modified, or Damaged Product, Electrical products, Incomplete Products (e.g. missing keys, levers, roses, etc).

All products returned as "Goodwill" must meet the following criteria to be considered a return:

- Be in original, unmarked, and undamaged cartons.
- Be valued in excess of \$250.00 net.
- Shipped and invoiced within the previous 120 days.
- SARGENT TurboShip product, please refer to the TurboShip catalog for return policy.
- Can't be custom, non-cataloged goods, master-keyed or 10B Finished products.

A **MINIMUM** Reprocessing Fee of **45%** will be charged. Upon receipt and verification by SARGENT® that the returned merchandise meets the foregoing conditions, a credit will be issued for the original invoice amount less the **MINIMUM 45%** Reprocessing Fee.

Defective goods and "Goodwill" products that meet the foregoing criteria, may be returned by fulfilling the following conditions:

- Send an RGA request in writing to the SARGENT® Sales Representative serving the Purchaser's area.
- Ensure the RGA labels that are sent to Purchaser by SARGENT® are visible on return goods shipment.
- Ensure that the RGA number appears on the return shipment label and is legible.
- Return the authorized merchandise within sixty (**60**) days from the date of RGA issuance date.
- Return shipments must be freight prepaid to the location specified on the RGA. SARGENT® is not liable for damages or shortages to product during shipping.

Electro Mechanical Defective Product Returns:

In addition to the above, the following conditions apply:

- Defective product return must be under warranty
- Case # must be used within 7 days of issuance
- Returned product must be found defective or nonfunctional upon test at factory
- Returned product must not have been damaged during installation process

No credit may be taken or issued prior to RGA approval and receipt of product.

All defective goods within the terms of our limited warranty may be returned for credit or replacement.

Taxes:

Prices do not include any present or future Federal, State, or Local property, license, privilege, sales, use, excise, gross receipts or other like taxes or assessments, which may result from transactions or any services performed in connection herewith.

Governing Law:

The rights and obligations of the parties shall be governed by the laws of the State of Connecticut, excluding any conflicts of law provisions. The United Nations Convention on Contracts for the International Sale of Goods shall not apply to this Agreement.

Limited Warranty:

The Terms and Conditions outlined above are subject to SARGENT® Limited Warranty, which is included in this Price List and incorporated herein by reference.

Product Modifications:

SARGENT® products are not designed for or intended for aftermarket modification. The warranty on SARGENT® products becomes void if the product is modified in any way, regardless of whether the modification causes or contributes to any alleged defect. Warranty voiding modifications include, but are not limited to, third-party electrification of non-electric products and/or the installation of non-approved or non-SARGENT® components.

If a SARGENT® product is modified it no longer meets industry certification and quality control standards applicable to the original product and is no longer a genuine SARGENT® product. A modified product may not be sold as a SARGENT® product and no SARGENT® trademarks or certification marks based on the original SARGENT® product, such as U.L. or ANSI/BHMA marks, may appear anywhere on the modified product or on any packaging, literature or instructions sold with the modified product.

All original SARGENT® packaging and literature carries SARGENT® trademarks and must be destroyed if the original SARGENT® product is modified. Portions of the product that carry a SARGENT® trademark or certification mark, such as mortise faceplates, lock bodies, etc. must be discarded and/or replaced by the party making the modification. U.L. and other certification testing and marking are also the responsibility of the party making modification. The use of SARGENT® trademarks on modified products constitutes trademark infringement.

Fire Rated Openings:

Any retrofit or other field modification to a fire rated opening can potentially impact the fire rating of the opening, and SARGENT makes no representations or warranties concerning what such impact may be in any specific situation. When retrofitting any portion of an existing fire-rated opening, or specifying and installing a new fire-rated opening, please consult with a code specialist or local code official (Authority Having Jurisdiction) to ensure compliance with all applicable codes and ratings.

Trademark Use Policy: ASSA ABLOY Americas

The following policy ("Policy") of ASSA ABLOY Americas ("ASSA ABLOY"), and all of its affiliated group companies (collectively, the "Group Companies"), applies to the use of certain intellectual property of all such Group Companies, including all trademarks, names, logos, product images, and related information (the "ASSA ABLOY Marks"). ASSA ABLOY Marks are proprietary and critical to the success of ASSA ABLOY and the Group Companies, and may only be used in strict compliance with this Policy.

This Policy covers any person or entity reselling any product of any Group Company with the consent of such Group Company (each, an "Approved Reseller"). Each Approved Reseller has a non-exclusive right to use certain of the ASSA ABLOY Marks relating to any of the Group Companies for which it is an Approved Reseller, subject to the following conditions:

- (1) Approved Reseller's use of ASSA ABLOY Marks must be truthful, fair, and not misleading;
- (2) Approved Reseller's advertising must clearly indicate that it is advertising of the Approved Reseller, and is not advertising of ASSA ABLOY;
- (3) Approved Reseller may not use any ASSA ABLOY Marks as part of or in connection with a domain name;
- (4) Approved Reseller's advertising must not imply or suggest an association between the Approved Reseller and ASSA ABLOY other than that of buyer and seller;
- (5) Approved Reseller's use of ASSA ABLOY Marks must be a positive representation of ASSA ABLOY, the Group Companies, and their products;
- (6) Approved Reseller's trade name must be more predominant on Approved Reseller's advertising than the ASSA ABLOY Marks;
- (7) Approved Reseller's use of ASSA ABLOY Marks must include the trademark symbol ® or TM, as appropriate, along with the following trademark legend printed in legible text on the Web page or document containing ASSA ABLOY Marks: "[describe ASSA ABLOY Marks] are trademarks or registered trademarks of ASSA ABLOY, Inc. or one of its affiliates in the United States and other countries.";
- (8) Approved Reseller must not make modifications of any ASSA ABLOY Marks; and
- (9) Approved Reseller may use only ASSA ABLOY Marks associated with the Group Companies for which it is an Approved Reseller (e.g., an Approved Reseller that sells Group Company X products but not Group Company Y products may use Group Company X trademarks in connection with its sale of Group Company X products, but may not use Group Company Y trademarks).

PARTNER SERVICES IN CANADA

USA & Canada Prices Effective May 1, 2021

PARTNER SERVICES IN CANADA

Business Hours: Customer Service Hours: 8:00 AM to 4:30 PM Eastern Standard Time.

Toll Free Telephone Number: 1-800-461-3007

Order Fax Number: 1-800.461.8989.

Order email: orders.dss.ca@assaabloy.ca

RGA email: rga.dss.ca@assaabloy.com

Technical Support email: techsupport.dss.ca@assaabloy.com

Customer Support: Ontario email: customerservice.dss.caontario@assaabloy.com

Customer Support: East email: customerservice.dss.caeast@assaabloy.com

Customer Support: West email: customerservicedss.cawest@assaabloy.com

2021 Canadian Calendar:

January 1: New Year's Day

February 15: Family day

April 2: Good Friday

May 24: Victoria Day

July 1: Canada Day

August 2: Civic Holiday

September 6: Labour Day

October 11: Thanksgiving Day

December 25: Christmas Day

December 26: Boxing Day

For Terms & Conditions and Warranty information pertaining to product sales in Canada, please visit www.assaabloy.ca/terms.

Note that some products may not be available in Canada as well as some of the programs offered in this price book may differ between the USA and Canada. Please contact your sales representative for more information.

ASSA ABLOY reserves the right to review Approved Reseller's usage of ASSA ABLOY at any time and may:

- (a) require changes to the use of ASSA ABLOY Marks at any time in its sole discretion, which changes must be implemented within 30 days of written notice to Approved Reseller;
- (b) condition the use of ASSA ABLOY Marks on ASSA ABLOY's prior approval use, which approval may be withheld in its sole discretion;
- (c) revoke permission to use ASSA ABLOY Marks at any time for any or no reason days prior written notice to Approved Reseller; and
- (d) revoke permission to use ASSA ABLOY Marks immediately upon notice to Reseller in the event Approved Reseller is in violation of this Policy, or of any agreement with ASSA ABLOY or any Group Company.

Approved Reseller's right to use ASSA ABLOY Marks in no way conveys to Approved any proprietary or economic interest in any ASSA ABLOY Marks.

Use of ASSA ABLOY Marks in violation of this Policy may result in severe civil and liabilities. ASSA ABLOY will vigorously enforce this Policy by seeking all appropriate remedies, including, but not limited to, pecuniary damages and injunctive relief.

TECHNICAL INFORMATION AND ADVICE:

- (a) All designs, data and specifications provided by company are proprietary and will not be disclosed or reused by customer without the prior written consent of Company;
- (b) Company assumes no obligation or liability for any advice given by Company, the results obtained, or damages incurred, and all such advice is given and accepted at Customer risk.

LIMITED WARRANTY:

SARGENT® warrants that its products sold under the "SARGENT" trade name in the United States of America are free from defects in workmanship and materials under normal use and service. This warranty does not cover defects or damage arising from improper installation, lack of or improper maintenance, improper storage, shipping and handling, corrosion, erosion, ordinary wear and tear, misuse, abuse, accident, unauthorized service, or use with unauthorized non-SARGENT products or parts. This warranty is void if any modification is made to the warranty product, regardless of whether the modification causes or contributes to the alleged defect. All modifications are made at the risk of the party making the modification. The only liability of SARGENT®, in tort or contract whether under this warranty or otherwise, shall be limited to the repair or replacement of any product or component part which shall prove defective as covered by this warranty, within the stated time period listed below, after delivery to the original purchaser.

• 281, 351, 1431, 1331 Series Closer Body	25 years
• 1130 Series Closer Body	15 years
• 268, 269, 278, 422 Series Closer Body	10 years
• 10X Line, 11 Line Bored-In Lever Lock	10 years
• 9200/8200/7800 Series Mortise Lock	10 years
• FM6100 and 7300 Multipoint Locks	7 Years
• 10 Line Bored-In Lever Lock	7 years
• 7000 Series Vertical Rod Lock	5 years
• 7900 Series Mortise Lock	5 years
• 80/90 Series Exit Device, 56- Electric Latch Retraction Option	5 years
• Overhead Holders & Stops	5 years
• 7 Line Bored-In Lever Lock	5 years
• 8X Line Bored-In Knob Lock	3 years
• 20/30 Series Exit Device or Trim	3 years
• All Electromechanical and Electronic Products	2 years
• All other SARGENT products	1 year

**CYLINDER SERVICE FEE
AND LIMITED WARRANTY**

USA & Canada Prices Effective May 1, 2021

Finishes:

SARGENT finishes are covered by a limited warranty period of one year after invoice date.

Warranty for Cylinders Factory or Field Combined:

Cylinders shall be periodically lubricated depending on environmental conditions.

FLUID FILM is recommended. Petroleum based liquid lubricants should only be used in cylinders in harsh or corrosive environments and should not be mixed with dry lubricants. SARGENT® cylinders and/or core warranty will be voided if used in non-SARGENT® locking devices.

Warranty for Cylinders Field Combined:

1. Keys shall be cut to the SARGENT® key biting specifications required for the particular keyway and depth system.
2. All pin lengths shall be selected according to prevailing factory standards.
3. Original SARGENT® cylinder components, including pin tumblers and key blanks, shall be used.
4. We reserve the right to void the warranty if we deem that a malfunction is a result of non-original components which do not conform to SARGENT® standards.

Keying Systems:

All bittings shall be originated or authorized by the SARGENT® Key Systems Department to be compatible with one another in a specific type of cylinder (conventional, security, high security, interchangeable core, removable core) and within a particular keying system. SARGENT® will not pay for the cost of repair performed other than in accordance with this warranty. Refer to our Returned Goods Policy regarding the return of a product or component part believed to be defective as covered by this warranty. A brief description of the defect will be required. Product will be examined upon return. In the event such examination reveals a defect covered by this warranty, the product will be repaired or replaced.

THIS WARRANTY IS IN LIEU OF ALL OTHER EXPRESS WARRANTIES. TO THE EXTENT PERMITTED BY LAW, ALL IMPLIED WARRANTIES ARE LIMITED TO THE DURATION OF THIS WARRANTY. SARGENT® MANUFACTURING COMPANY SHALL NOT BE LIABLE FOR ANY INCIDENTAL OR CONSEQUENTIAL DAMAGES. NO AGENT, SALES REPRESENTATIVE OR DEALER HAS THE AUTHORITY TO INCREASE OR ALTER THE OBLIGATIONS OF THIS WARRANTY.

SOME STATE DO NOT ALLOW LIMITATIONS ON HOW LONG AN IMPLIED WARRANTY LASTS OR THE EXCLUSION OR LIMITATION OF INCIDENTAL OR CONSEQUENTIAL DAMAGES, SO THE ABOVE LIMITATIONS OR EXCLUSIONS MAY NOT APPLY TO YOU.

THIS WARRANTY GIVE YOU SPECIFIC LEGAL RIGHTS, AND YOU MAY ALSO HAVE OTHER RIGHTS WHICH VARY FROM STATE TO STATE.

SARGENT® Manufacturing Company

Finishes

Items will be furnished only in finishes as listed in this price book. Not all finishes are available for all product lines. Consult each product section for applicable finishes.

SARGENT Symbol	BHMA Symbol	Material
3	(BHMA 605)	Bright brass, clear coated
4	(BHMA 606)	Satin brass, clear coated
9	(BHMA 611)	Bright bronze, clear coated
10	(BHMA 612)	Satin bronze, clear coated
10B	(BHMA 613)	Dark oxidized satin bronze, oil rubbed
10BE	(BHMA 613E)	Dark oxidized satin bronze - equivalent
10BL	(BHMA 614)	Dark oxidized satin bronze, clear coated
14	(BHMA 618)	Bright Nickel, clear coated
15	(BHMA 619)	Satin Nickel, clear coated
20D	(BHMA 624)	Statuary bronze dark powder coated
26	(BHMA 625)	Bright chromium plated
26D	(BHMA 626)	Satin chromium plated
32	(BHMA 629)	Bright stainless steel
32D	(BHMA 630)	Satin stainless steel
BSP	n/a	Black suede powder coat
WSP	n/a	White suede powder coat

Exposed Metal Parts Furnished same finish as Escutcheon or Rose Bushing

SARGENT Symbol	BHMA Symbol	Painted Finishes
EB	(BHMA 690)	Sprayed bronze enamel or polyester powder coated to match finish 10B
ED	(BHMA 693)	Sprayed black enamel or polyester powder coated to match finish 20D
EN	(BHMA 689)	Sprayed aluminum enamel or polyester powder coated
EP	(BHMA 691)	Sprayed bronze enamel or polyester powder coated to match finish 10
EAB	(BHMA 696)	Brass enamel or polyester powder coated to be used with brass finishes
ERD		Red powder coat

When prime coat is required the EN finish will be furnished as this is suitable for painting.

GI-10 GENERAL INFORMATION

SARGENT®

ASSA ABLOY

MERCHANDISING AIDS

USA & Canada Prices Effective May 1, 2021

Note: Sample mounts only. Hardware needs to be ordered separately.

Cylinder		Price
DG-3110	Degree Cylinder Sample Kit	\$250.00
Bored Lock (Solid Light Oak Block)		
MSB001	6 and 8 Line Bored Locks And 480 Deadlock – 2-3/4" Backset Only	\$167.00
MSB002	6500 / 7 / 10 Line Cylindrical Lock	\$178.00
MSB007	T-Zone (11 Line) Series Bored Lock	\$178.00
MSB014	DL Series	\$158.00
7800/8200/8200BHL/9200 Line Locks (Solid Light Oak Block)		
MSM004	15 Function	
MSM005	05, 24, 25, 45, 50 Functions	\$490.00
MSM003	04 & 37 functions	
MSM015	9200 Series	\$195.00
MSM030	Sectional Trim Mortise Indicator	\$190.00
MSM031	Escutcheon Trim Mortise Indicator	\$190.00
Roseless Trim Locks (Maiman Thermal Fused flush door, Paraon Cherry Block)		
MSM010	R8237 Roseless	\$150.00
MSM011	Roseless 5 lever	\$670.00
MSB012	RDLU65 Roseless	\$99.00
8200 ALP Trim (Maiman Thermal Fused flush door, Gentle Anigre Block)		
MSB013	HP Series ALP	\$132.00
MSM012	8215 ALP	
MSM013	8205, 25, 45, 50 ALP	\$217.00
MSM014	8204& 37 ALP	
8200 BHW Trim		
MSM023	Passage	
MSM024	Cylinder	\$260.00
MSM025	Cylinder and Turn Button	
4870 Line Locks (Solid Light Oak Block)		
MSM001	4875/77 Series	
MSM002	4874 Series	\$179.00
MSB009	SSL1	
114 and 115 Hospital Latch		
MSB010	Solid Light Oak Block for 2 -3/4" Backset only	\$146.00
Exit Devices (Solid Light Oak Block)		
MSE006	8810 only (E- size rail only)	
MSE018	9710 only	\$324.00
MSE019	9800 with STS trim	
MSE020	9900 with STS trim	
Door Closers (Solid Light Oak Block)		
MSD001	351 Series – "O" Arm Only	\$364.00
MSD002	1431 Series – "O" Arm Only	\$364.00
MSD003	281 Series – "O" Arm Only	\$337.00
MSD004	1131 Series	\$364.00

Experience a safer
and more open world

Copyright © 2002-2021 Sargent Manufacturing Company, an ASSA ABLOY Group company. All rights reserved.
Reproduction in whole or in part without the express written permission of Sargent Manufacturing Company is prohibited.
Contact us at: 800-727-5477 or visit www.sargentlock.com. In Canada contact us at: 800-461-3007 or visit www.assaabloydss.ca

USA & Canada Prices Effective May 1, 2021

Note: Sample mounts only. Hardware needs to be ordered separately.

Electronic Access Control Products		
MSB003	10 Line – Keypad KP & KU	\$205.00
MSB004	10 Line – Harmony	\$225.00
MSB005	10 Line – Passport	\$200.00
MSB006	10G77 – Low Profile (Bored-in)	\$271.00
MSE002	59-80 Series Exit Device	\$310.00
MSE003	8800 Series Passport	\$310.00
MSE004	8900 Series Passport	\$360.00
MSE007	8876 – Low Profile (Rim Exit - LHR)	\$326.00
MSE008	HT-80 Series Exit	\$815.00
MSE009	8800 Series Harmony	\$337.00
MSE010	8900 Series Harmony	\$230.00
MSE011	8600 Series Harmony	\$230.00
MSE012	8700 Series Harmony	\$230.00
MSE013	KP 8900 Series Exit Device	\$310.00
MSE014	56- (Electric Latch Retraction) 80 Series Exit Device	\$569.00
MSE015	32" for 80 Series Rim	\$350.00
MSE016	36" for 80 Series Rim	\$370.00
MSE017	NB-8700 Series Harmony	\$230.00
MSE021	KP-8800 Series	\$265.00
MSM006	8200 Series - Passport	\$200.00
MSM007	KP 8200 Mortise Lock	\$286.00
MSM008	8200 Series – Low Profile (Mortise)	\$318.00
MSM009	H1 8200 Series	\$318.00
MSM016	H1/H2 R8200 Series	\$405.00
Aperio Hubs		
MSA001	AH20 Aluminum	\$300.00
MSA003	AH30 Aluminum	
Finish Samples		
1111	Set of standard finishes on 11/4" diameter	\$56.00
SFP1	Sample Finish Plate	\$180.00
Lever Sample Kit		
82-5365	Kit includes foam insert & bag only. Levers ordered separately	\$160.00
(US3, US4, US9, US10, US10B, US10BE, US10BL, US14, US15, US20D, US26, US26D, US32, US32D, BSP, WSP, EB, ED, EN, EP, EAB)		

GI-12 GENERAL INFORMATION

SARGENT®

ASSA ABLOY

WEIGHT CHART

USA & Canada Prices Effective May 1, 2021

Freight Weight Chart

Shipping weights listed depict an approximation of the average weight for any lock, exit device, or closer and are meant only for use in estimating weight.

Standard Packing

Product Line

Locksets	Function	Case Quantity	Average Weight Per Case (lbs.)
7800 Line	7805 w/trim	6	42
7900 Line	7904 w/trim	6	42
8200 Line	8205 w/trim	6	42
T-Zone (11 Line)	11G05	10	45
10 Line	10G05	10	45
7 Line	7G05	10	41
6 Line	6G05	10	21
6500 Line	65G05	10	41

Exit Devices

90 Series	9863 w/trim	1	15
80 Series	8863 w/trim	1	15
20 Series	2828F	1	9

Closers

351 Series	UO	4	34
281 Series	O	2	24
1431 Series	UO	4	32
1331 Series	JUO	4	30
1131 Series	RU	4	22

Overhead Holders & Stops

590/690 Series	1	6
1530/1540 Series	1	4

Screw Substitutions

Price

Machine screw in place of wood screw	No Extra Charge
Phillips head screws	No Extra Charge
Spanner head in place of standard screws, specify WS or MS (37- option)	See each product section for add
Six lobe security (Torx) screws (36- option)	See each product section for add
82-3856 Spanner Bit Kit - (sizes 4, 6, 8, 10, 12 & 1/4"), (1/4" Driver)	\$133.88 Each
82-3855 Torx Bit Kit - (sizes T8, T9, T10, T15, T20, T25, & T27), (7/16" Driver)	\$172.00 Each

Experience a safer
and more open world

Copyright © 2002-2021 Sargent Manufacturing Company, an ASSA ABLOY Group company. All rights reserved.
Reproduction in whole or in part without the express written permission of Sargent Manufacturing Company is prohibited.
Contact us at: 800-727-5477 or visit www.sargentlock.com. In Canada contact us at: 800-461-3007 or visit www.assaabloydss.ca

USA & Canada Prices Effective May 1, 2021

Master Option List		
Option	Series Used	Description
1	7L, 10L, 7800, 7900, 8200, 470	1-1/16" wide front for 1-3/8" doors
3	8200, 9200	Stainless Steel Hub
5P	Cylinders for Conventional Key Systems	Cylinders for Conventional Key Systems
10	6, 7, 8X, 10, T-Zone, 6500, 7800, 7900, 8200, 9200, 7000, 20, 30, 80, 8888, 90, 9898, 470, 480, 4870, 758, 858, Keyswitch, KP10, 10ProfileSer., 10RF-Actuation, KP8200, 8200ProfileSer., 8200RF-Actuation, KP88, 88ProfileSer., 88RF-Actuation, KP89, 89ProfileSer., 89RF-Actuation	SARGENT Signature Key System
11	6, 7, 8X, 10, T-Zone, 6500, 7800, 7900, 8200, 9200, 7000, 20, 30, 80, 8888, 90, 9898, 9800, 470, 480, 4870, 758, 858, Keyswitch, KP10, 10L Profile Ser., 10LRF-Actuation, KP8200, 8200ProfileSer., 8200RF-Actuation, KP88, 88 Profile Ser., 88RF-Actuation, KP89, 89 Profile Ser., 89RF-Actuation	SARGENT XC Key System
12	20, 30, 83, 85, MD84, MD86, WD86, LS-LP-LR-86, 87, NB87, 88, 8888, 89, 90, 980, L980, KP88, 88ProfileSer., 88RF-Actuation, KP89, 89ProfileSer.,	UL Fire Label
	89RF-Actuation, 5300, 7000, DL, RDL	Fire Guard with Smoke Detector
12HC	8700 (all functions), 8800 (04, 10, 13, 15), 980	UL Fire Label/Hurricane Code
13	6, 470	Lockset x Front & Strike with 1/4" Radius (2-3/8" Backset only)
	1331, 1431, 268, 269, 278, 281, 351, 422	Door Closer Body Only
14	6500, 6, 7, DL	Full Lip Strike #505
	8700, 9700	Sliding Bolt Bottom Case
15	6, 470	Drive-In Guarded Latchbolt (2-3/8" Backset Only)
16	20, 30, 80, KP88, 88 Profile Ser., 88RF-Actuation, KP89, 89 Profile Ser., 89RF-Actuation	Cylinder Lockdown Feature
	480	400 "T" Shaped Strike (2-3/4" x 1-1/8")
17	6	Lockset x 2-3/4" Backset x 2-1/4" x 1" Front
19	80, KP88, 88 Profile Ser., 88RF-Actuation, KP89, 89 Profile Ser., 89RF-Actuation	Pushbar without Lexan Touchpad
20	6500, 10, 480, DL	2-3/8" Backset
21	6, 7, 8X, 10, T-Zone, 6500, 7800, 7900, 8200, 9200, 7000, 20, 30, 80, 8888, 90, 9898, 470, 480, 4870, 758, 858, 4142, 4143, Keyswitch, KP10, 10 Profile Ser., 10RF-Actuation, KP8200, 8200 Profile Ser., 8200RF-Actuation, KP88, 88 ProfileSer., 88RF-Actuation, KP89, 89 ProfileSer., 89RF-Actuation	SARGENT Lost Ball Construction Key System
22	6500, 6, 7, 8X, 10, T-Zone, 7800, 7900, 8200, 9200, 7000, 20, 30, 80, 8888, 90, 9898, 480, 4870, 758, 858, Keyswitch, KP10, 10 Profile Ser., 10RF-Actuation, KP8200, 8200 Profile Ser., 8200RF-Actuation, KP88, 88 Profile Ser., 88RF-Actuation, KP89, 89 Profile Ser., 89RF-Actuation	SARGENT Split Key Construction Key System (existing systems only)
23	10, T-Zone, KP10, 10ProfileSer., 10RF-Actuation	3-3/4" Backset
	6	3-3/4" Backset x 2-1/4" x 1-1/8" Front
	7800, 8200, 9200, 8300, 8900, KP8200, 8200ProfileSer., 8200RF-Actuation, KP89, 89ProfileSer., 89RF-Actuation	Flat 4-7/8" ANSI Strike
24	6	2-3/4" Backset x 2-1/4" x 1-1/8" Front
	114, 115	2-3/4" Backset
25	10, T-Zone, KP10, 10ProfileSer., 10RF-Actuation	5" Backset
	6	5" Backset x 2-1/4" x 1-1/8" Front
26	114, 115	7" Backset
28	6500, 6, 7, 8X, 10, T-Zone, DL, 114, 115, KP10, 10ProfileSer., 10RF-Actuation	ANSI A-115.2.1971 Curved Lip Strike (#808)
	470, 480	ANSI A-115.2.1971 Flat Lip Strike (#408)
	4870	ANSI A-115.2.1971 Flat Lip Strike (#7710)

GI-14 GENERAL INFORMATION

SARGENT®

MASTER OPTION LISTING

ASSA ABLOY

USA & Canada Prices Effective May 1, 2021

Master Option List		Description
Option	Series Used	
30	7, 10, T-Zone, KP10, 10ProfileSer., 10RF-Actuation	Lever to accept Schlage Cylinder-Cylinder is not provided
31	8X, T-Zone, DL, 7800, 7900, 8200, 9200, 7000, 80, 90, 97, 98, 99, Holders & Stops	Special Thickness Doors (Specify door thickness)
36	Cylindrical, Mortise, Closers, 80, 97, 98, 99, Exits, Holders & Stops, Aux. Locks, Deadlocks, 114, 115, 5300, 351EHT, 7000	6-Lobe Security Head Screws
37	Cylindrical, Mortise, Closers, 80, 97, 98, 99, Exits, Aux. Locks, Deadlocks, 114, 115, 5300, 7000	Spanner Head Screws
41	10, T-Zone, KP10, 10ProfileSer., 10RF-Actuation	3/4" Throw Latchbolt x 2-3/4" Backset
42	9700, 9800, 9900	
43	80	Flush End Cap
47	Cylinders	Special Cams
48	480	488 Strike 3-5/8" x 1-1/4"
49	7800, 8200	Visual Status Indicator/Occupancy Indicator w/ Emerg. Release
50	7800, 8200	Secured Indicator Rose
	Cylinders	Hotel Function (Lockout)
51	7800, 8200, 80, 97, 98, 99, 4870, 758, 858	Old Style Removable Core Cylinders for Existing Systems only
52	7800, 8200, 80, 97, 98, 99, 4870, 758, 858	Old Style Removable Construction Core Cylinders for Existing Systems only
53	83, 84, MD84, 85, MD86, WD86, 87, NB87, 88, 89, 7000	Latchbolt Monitor Switch
54	83, 84, MD84, MD86, WD86, 87, NB87, 88, 89, 97, 98, 99, 7000	Internal Microswitch in ET Control
55	30, 80	Signal Switch in Rail
	7000	Monitor Inside Lever
56	80	Remote Dogging/Latch Retraction
57	83, 84, MD84, 85, MD86, WD86, 87, NB87, 88, 89	Delayed Action (Magnet ordered separate)
58	80	Electric Dogging
59	83, 84, MD84, 85, MD86, WD86, 87, NB87, 88, 89	Electroguard
BC59	83, 84, MD84, 85, MD86, WD86, 87, 88, 89	Electroguard Boca Code (needs door status switch)
60	6, 7, 10, T-Zone, 6500, 7800, 7900, 8200, 9200, 7000, 20, 30, 80, 8888, 90, 9898, 480, 4870, 758, 858, Keyswitch, KP10, 10ProfileSer., 10RF-Actuation, KP8200, 8200ProfileSer., 8200RF-Actuation, KP88, 88ProfileSer., 88RF-Actuation, KP89, 89ProfileSer., 89RF-Actuation	SARGENT Removable Disposable Construction Core
63	6, 7, 10, T-Zone, 6500, 7800, 7900, 8200, 9200, 7000, 20, 30, 80, 8888, 90, 9898, 480, 4870, 758, 858, Keyswitch, KP10, 10ProfileSer., 10RF-Actuation, KP8200, 8200ProfileSer., 8200RF-Actuation, KP88, 88ProfileSer., 88RF-Actuation, KP89, 89ProfileSer., 89RF-Actuation	SARGENT Removable Core Cylinder
64	6, 7, 10, T-Zone, 6500, 7800, 7900, 8200, 9200, 7000, 20, 30, 80, 8888, 90, 9898, 480, 4870, 758, 858, Keyswitch, KP10, 10ProfileSer., 10RF-Actuation, KP8200, 8200ProfileSer., 8200RF-Actuation, KP88, 88ProfileSer., 88RF-Actuation, KP89, 89ProfileSer., 89RF-Actuation	SARGENT Removable Construction Core Cylinder
65	6300, 7300B	Uncombine Cores
6573	7, 10, T-Zone, 6500, 7800, 7900, 8200, 9200, 7000, 20, 30, 80, 8888, 90, 480, 4870, KP10, 10ProfileSer., 10RF-Actuation, KP8200, 8200ProfileSer., 8200RF-Actuation, KP88, 88ProfileSer., 88RF-Actuation, KP89, 89ProfileSer., 89RF-Actuation	Small Format Interchangeable 6-Pin Uncombine Core
65737P	7, 10, T-Zone, 6500, 7800, 7900, 8200, 9200, 7000, 20, 30, 80, 8888, 90, 480, 4870, KP10, 10ProfileSer., 10RF-Actuation, KP8200, 8200ProfileSer., 8200RF-Actuation, KP88, 88ProfileSer., 88RF-Actuation, KP89, 89ProfileSer., 89RF-Actuation	Small Format Interchangeable 7-Pin Uncombine Core

Experience a safer
and more open world

Copyright © 2002-2021 Sargent Manufacturing Company, an ASSA ABLOY Group company. All rights reserved.
Reproduction in whole or in part without the express written permission of Sargent Manufacturing Company is prohibited.
Contact us at: 800-727-5477 or visit www.sargentlock.com. In Canada contact us at: 800-461-3007 or visit www.assaabloydss.ca

USA & Canada Prices Effective May 1, 2021

Master Option List		
Option	Series Used	Description
68	7900, 8200, 9200	Lock furnished w/lever handle outside x knob inside
69	7900, 8200, 9200	Lock furnished w/lever handle inside x knob outside
70	7, 10, T-Zone, 6500, 7800, 7900, 8200, 9200, 7000, 20, 30, 80, 8888, 90, 480, 4870, KP10, 10 Profile Ser., 10RF-Actuation, KP8200, 8200 Profile Ser., 8200RF-Actuation, KP88, 88 Profile Ser., 88RF-Actuation, KP89, 89 Profile Ser., 89RF-Actuation	Small Format Interchangeable Disposable Plastic Construction Core
72	7, 10, T-Zone, 6500, 7800, 7900, 8200, 9200, 7000, 20, 30, 80, 8888, 90, 480, 4870, KP10, 10 Profile Ser., 10RF-Actuation, KP8200, 8200 Profile Ser., 8200RF-Actuation, KP88, 88 Profile Ser., 88RF-Actuation, KP89, 89 Profile Ser., 89RF-Actuation	Small Format Interchangeable 6-Pin Construction Core
73	7, 10, T-Zone, 6500, 7800, 7900, 8200, 9200, 20, 30, 80, 8888, 90, 480, 4870, KP10, 10ProfileSer., 10RF-Actuation, KP8200, 8200 Profile Ser., 8200RF-Actuation, KP88, 88 Profile Ser., 88RF-Actuation, KP89, 89 Profile Ser., 89RF-Actuation	Small Format Interchangeable 6-Pin Core
737P	7, 10, T-Zone, 6500, 7800, 7900, 8200, 9200, 20, 30, 80, 8888, 90, 480, 4870, KP10, 10 Profile Ser., 10RF-Actuation, KP8200, 8200 Profile Ser., 8200RF-Actuation, KP88, 88 Profile Ser., 88RF-Actuation, KP89, 89 Profile Ser., 89RF-Actuation	Small Format Interchangeable 7-Pin Core
74	7, 10, 11, 7800, 8200, 4870, 114, 115, 281, 351, 1431	Lead Lining or Wrapping
75	7, 10, T-Zone, 7800, 7900, 8200, 9200, KP10, 10ProfileSer., 10RF-Actuation, KP8200, 8200ProfileSer., 8200RF-Actuation	Milled Inside Lever, Knurled Inside Knob
	6500	Handicap Warning on Inside of Lever – Embossed Plastic backing
	94, 7000	Abrasive Strip on Rail
	97, 98, 99	Knurled Crossbar
76	7, 10, T-Zone, 7800, 8200, 9200, KP10, 10ProfileSer., 10RF-Actuation, KP8200, 8200ProfileSer., 8200RF-Actuation	Milled Outside Lever, Knurled Outside Knob
	6500	Handicap Warning on Outside of Lever – Embossed Plastic backing
	7900, 7000, 80, 97, 98, 99, KP88, 88ProfileSer., 88RF-Actuation, KP89, 89ProfileSer., 89RF-Actuation	Milled Outside Lever
	7, 10, T-Zone, 7800, 7900, 8200, 9200, KP10, 10ProfileSer., 10RF-Actuation, KP8200, 8200ProfileSer., 8200RF-Actuation	Milled Both Levers, Knurled Both Levers
77	6500	Handicap Warning on Both Levers – Embossed Plastic backing
	7000	Abrasive Strip on Rail, Abrasive Coating on Lever
	97, 98, 99	Knurled Crossbar, Abrasive Coating on Lever
78	Mortise Cylinder	Exposed Barrel
80	2900	Adjustable Hold Open Switch
	7L, 10L, T-Zone	Levers/Knobs to accept Keso and KesoF1 cylinders - no cylinders provided
81	7800, 7900, 8200, 7000, 80, 90, 9898, 4870, KP8200, 8200ProfileSer., 8200RF-Actuation, KP88, 88ProfileSer., 88RF-Actuation, KP89, 89ProfileSer., 89RF-Actuation	Cylinder to accept Keso(83) and KesoF1(F183) removable core - no core provided
F182	7L, 10, T-Zone, 7800, 7900, 8200, 7000, 80, 90, 9898, 4870, 856/857 Padlocks, Keyswitch, KP8200, 8200ProfileSer., 8200RF-Actuation, KP88, 88ProfileSer., 88RF-Actuation, KP89, 89ProfileSer., 89RF-Actuation	SARGENT KESO Security Cylinder - Patented - NEW Key Systems
82	7L, 10, T-Zone, 7800, 7900, 8200, 7000, 80, 90, 9898, 4870, 856/857 Padlocks, Keyswitch, KP8200, 8200ProfileSer., 8200RF-Actuation, KP88, 88ProfileSer., 88RF-Actuation, KP89, 89ProfileSer., 89RF-Actuation	SARGENT KESO Security Cylinder (Existing Systems only)
F183	7800, 7900, 8200, 7000, 80, 90, 9898, 4870, KP8200, 8200ProfileSer., 8200RF-Actuation, KP88, 88ProfileSer., 88RF-Actuation, KP89, 89ProfileSer., 89RF-Actuation	SARGENT KESO Security Removable Core Cylinder - Patented - NEW Key Systems
83	7800, 7900, 8200, 7000, 80, 90, 9898, 4870, KP8200, 8200ProfileSer., 8200RF-Actuation, KP88, 88ProfileSer., 88RF-Actuation, KP89, 89ProfileSer., 89RF-Actuation	SARGENT KESO Security Removable Core Cylinder (Existing Systems only)

GI-16 GENERAL INFORMATION

SARGENT®

MASTER OPTION LISTING

ASSA ABLOY

USA & Canada Prices Effective May 1, 2021

Master Option List		
Option	Series Used	Description
84	7800, 7900, 8200, 7000, 80, 90, 9898, 4870, Padlocks, KP8200, 8200ProfileSer., 8200RF-Actuation, KP88, 88ProfileSer., 88RF-Actuation, KP89, 89ProfileSer., 89RF-Actuation	SARGENT KESO Security Removable Construction Core Cylinder
85	11L, 10L, 7L, 6500, 8200, 7800, 7900, 9200, 7000	Tactile Warning - Abrasive Coating on Inside Lever
86	11L, 10L, 7L, 6500, 8200, 7800, 7900, 9200, 7000, 80, 90	Tactile Warning - Abrasive Coating on Outside Lever
87	11L, 10L, 7L, 6500, 8200, 7800, 7900, 9200, 7000, 80, 90	Tactile Warning - Abrasive Coating on Outside & Inside Lever
91	5300, 10ProfileSer., 8200ProfileSer., 88ProfileSer., 89ProfileSer.	Remote Power
94	5300	Automatic Re-Arm
ABC	281	Advanced Backcheck
AL	83, 84, MD84, 85, MD86, WD86, 87, NB87, SP-PP-PR87, 88, 89	Alarmed (not available with 56 thru 59 options)
AV	7800, 8200, 9200	Anti-Vandal Pull Trim
BC	80 Series Exit Devices	Boca Code
BP	7800, 8200	Distributor Bulk Pack Program - Lockbodies
BR	6, 7, 10, T-Zone, 6500, 7800, 7900, 8200, 9200, 7000, 20, 30, 80, 8888, 90, 9898, 9800, 980 Mullions, 470, 480, 4870, 5300, KP10, ProfileSer., 10LRF-Actuation, KP8200, 8200ProfileSer., 8200RF-Actuation, KP88, 88ProfileSer., 88RF-Actuation, KP89, 89ProfileSer., 89RF-Actuation	SARGENT Bump Resistant Cylinder
C-	1131	Cover
CL	4000Ser.	Low Ceiling
CPC	7000, 281, 351, 422, 1431, 590, 690, 8300, 8400, 8500, 8600, 8700, 8800, 8900, 9700, 9800, 9900	Clear Powder Coat over 26D/32D
DA	278, 281, 351, 1431, 268, 269, 351EHT	Delayed Action
DG1	6, 7, 8X, 10, T-Zone, 6500, 7800, 7900, 8200, 9200, 7000, 20, 30, 80, 8888, 90,	SARGENT DEGREE Key System
DG2	9898, 480, 4870, 758, 858, Keyswitch, KP10, 10ProfileSer., 10RF-Actuation,	SARGENT DEGREE Key System
DG3	KP8200, 8200ProfileSer., 8200RF-Actuation, KP88, 88ProfileSer., 88RF-Actuation, KP89, 89ProfileSer., 89RF-Actuation	SARGENT DEGREE Key System
DM	10LProfile(G1), 8200 Profile(G1), 80Series Profile(G1)	Forced/Propped Door Harness
DX	7800, 8200	Deadbolt Monitoring
EC	281, 1331 series	Environmentally friendly ABS plastic cover
F1	KESO Cylinders/Keys	Patented Keso Key System
FM	8700 (E, F Rail only)	2Pt. Latching, Complies with FEMA 361
FW	7, 10	Freewheeling
G1	10LProfileSer., 10LRF-Actuation, 8200ProfileSer., 8200RF-Actuation, 88/89ProfileSer., 88/89RF-Actuation,	v.G1 Next Generation software
GL	8500, 8800, 8888	Guarded Latch
HC	8700 (all functions), 8800 (not available with 04, 10, 13, 15), 980	Hurricane Code
HC4	8700 Series	Hurricane Resistant
IDP	Harmony Series 8200	Integrated Door Position Switch
IS	7800, 8200, 9200	Inside Working Trim Sets
LB	7900, 8200, 4870	ADA Extra Large Thumbturn
LC	Less Cylinder All products w/cylinders	Less Cylinder
LD	80 series exits	Less Dogging
LX	8200	Latchbolt Monitor
M-	9200	
MC	351, 281, 1431, 422, 351EHT	Closer with Metal Cover
NB	7000, 8400, 12-MD8400, MD8600, WD8600, 8700, 306, 313 Aux Controls	No Bottom Rod
OBS	8200, 7800, 9200	Open Back Strike
OS	7800, 8200, 9200	Outside Working Trim Sets

Experience a safer
and more open world

USA & Canada Prices Effective May 1, 2021

Master Option List		
Option	Series Used	Description
P-	114, 115, HP series	Engraved Paddles "Push" and "Pull"
PL	80 Series	SARGuide™ Photoluminescent Coating
RX	10, 7900, 8200	Request to exit or enter switch
SC	6, 6500, 7, 10, T-Zone, 7800, 7900, 8200, 7000, 20, 30, 80, 8888, 90, 470, 480, 4870, 758, 858, KP10, 10ProfileSer., 10RF-Actuation, KP8200, 8200ProfileSer., 8200RF-Actuation, KP88, 88ProfileSer., 88RF-Actuation, KP89, 89ProfileSer., 89RF-Actuation	Schlage "C" Keyway Cylinder - "0" Bitted
SE	6, 6500, 7, 10, T-Zone, 7800, 7900, 8200, 7000, 20, 30, 80, 8888, 90, 470, 480, 4870, 758, KP10, 10ProfileSer., 10RF-Actuation, KP8200, 8200ProfileSer., 8200RF-Actuation, KP88, 88ProfileSer., 88RF-Actuation, KP89, 89ProfileSer., 89RF-Actuation	Schlage "E" Keyway Cylinder - "0" Bitted
SF	7L, 10L, 11L	L Lever to accept Schlage Large Format Interchangeable Core (supplied less core, tailpiece included)
SG	6, 7, 9, 10, T-Zone, 7800, 8200, 9200, 1431, 281, 422, 351, 80, 90, O/H Holders & Stops, 4870, 114/115, KP10, 10ProfileSer., 10RF-Actuation, KP8200, 8200ProfileSer., 8200RF-Actuation, KP88, 88ProfileSer., 88RF-Actuation, KP89, 89ProfileSer., 89RF-Actuation	MicroShield® - an antimicrobial powdercoat finish
SL	T-Zone	High Security Lever Attachment
SRI	268, 269, 278, 281, 1131, 1331	Additional Special Rust Inhibitor (SRI)
T1	7900, 8200, R8200	Decorative thumbturn; backplate matches rose design chosen
T2	7900, 8200, R8200	Decorative square thumbturn; backplate matches rose design chosen
T3	7900, 8200, R8200	Decorative cylinder thumbturn; backplate matches rose design chosen
TB	7000, 351, 281, 1431, 278, 422, 1331, 1131, 2727, 2828, 3727, 3828, 8300, 8600, 8500, 8700, 8800, 8900, 9400, 9700, 9800, 9900, 114, 115, 5300, 351EHT, 2408, 2900	Thru Bolt
TL	80	SARGuide™ - Illuminated Touchpad
	8200 x WT(escutcheon)	SARGuide™ - Illuminated WT Escutcheon
TR	7800, 8200	Distributor Bulk Pack Program - Complete Trim Packs
WBS	11L, 10L, 7L, DL, 6L, 8200, 7800, 7900, 9200	Wrought Box Strike
WS	8500, 8800, & 8900 Series	Windstorm Certified
YC	11L	L or P Lever to accept Yale® 6-pin fixed core cylinder
YC7P	11L	L or P Lever to accept Yale® 7-pin fixed core cylinder
YRC	11L	L or P Lever to accept Yale® 6-pin LFIC
YRC7P	11L	L or P Lever to accept Yale® 7-pin LFIC

GI-18 GENERAL INFORMATION

SARGENT®

PARTNER SERVICES GENERAL INFORMATION

ASSA ABLOY

USA & Canada Prices Effective May 1, 2021

PARTNER SERVICES IN THE UNITED STATES

Business Hours: The Partner Services Team (except Customer Service)
is available: 8:00 AM to 4:30 PM Eastern Standard Time.

Customer Service Hours: 8:00 AM to 7:30 PM EST (Monday – Thursday)
8:00 AM to 5:00 PM EST (Friday)

Toll Free Telephone Number: 1-800-727-5477

Order Fax Number: 1- 800-906-6606. **Order email:** usnew.orderentry@assaabloy.com

Contact Phone Numbers: Included is a list of Who's Who for the Partner Services Team. This list includes Team Member's direct extensions and email addresses.

2021 Calendar:

- January 1 (New Years)
- January 18 (Martin Luther King, Jr. Day)
- February 15 (President's Day)
- April 2 (Good Friday)
- May 31 (Memorial Day)
- July 5 (4th of July)
- September 6 (Labor Day)
- November 25 and 26 (Thanksgiving)
- December 23, 24 and 27 (Christmas)

SARGENT Website: We offer a full service website www.sargentlock.com. The Partner Services page of the SARGENT website includes templates, instruction sheets, configurable cut sheets, wiring diagrams and our latest product developments. All product information catalogs are also available on this website.

RGA Policy: Please refer to GI-4 of the General Information Section.

WHO'S WHO AT SARGENT

USA & Canada Prices Effective May 1, 2021

CUSTOMER SUPPORT SERVICES

(Order Processing, Customer Service, Keying)

Telephone: 800-727-5477**Director, Customer Support Services- AEHG**

Lynn Higgins

1-5948

Lynn.Higgins@assaabloy.com

Manager, Keying, Order Entry & EBusiness

Bethany Cordeiro

1-4271

Bethany.Cordeiro@assaabloy.com

com

Manager, Customer Services

Susanna Bria

1-5584

Susanna.Bria@assaabloy.com

Order Processing – Edit/Enter Orders**Fax Orders To: 800-906-6606****Email standard orders to: orders.sargent@assaabloy.com****Email turbo orders to: turboorders.sargent@assaabloy.com****Customer Service – Expedites, Returns,
Change Orders, Line Suspensions****Fax: 888-863-5054****Telephone: 800-727-5477****For Customer / Technical Support Services in Canada
Please see page GI-6**

WHO'S WHO AT SARGENT

USA & Canada Prices Effective May 1, 2021

Telephone: 800-727-5477 • Fax Orders To: 800-906-6606

Customer Service Team Members
Expedites, Returns, Change Orders, Line Suspensions
Customer Service's Fax: 888-863-5054 • Telephone: 800-727-5477
Email: customerservice.sargent@assaabloy.com

Manager of Customer Service

Susanna Bria	1-5584	Susanna.Bria@assaabloy.com
--------------	--------	----------------------------

Customer Support Specialists

(Returns, Expedites, Product Questions, Changes, Suspensions)

Western Region 2, 4 (Southeast & Western)

Luci Muzyk: (A15, A37, A38, A39, & GA Only)	1-6852	Luci.Muzyk@assaabloy.com
---	--------	--------------------------

Northeast Regions 1

Monique Delgado: (A02, A03) & OEM Customers	1-5713	Monique.Delgado@assaabloy.com
---	--------	-------------------------------

Central Region 3, 4

Shirley Sotaski: (A27, A28, A43)	1-5715	Shirley.Sotaski@assaabloy.com
----------------------------------	--------	-------------------------------

Western Region 4 (South)

Anne Dempster: HI, Arrow	1-5861	Anne.Dempster@assaabloy.com
--------------------------	--------	-----------------------------

Western Region 4

Miriam Cass: (A01, A44, SC)	1-3310	Miriam.Cass@assaabloy.com
-----------------------------	--------	---------------------------

NE & Midwest Atlantic Region 1

Anne Dempster: (A07 & A08)	1-5861	Anne.Dempster@assaabloy.com
----------------------------	--------	-----------------------------

Northern Region 1, Central Region 3, Southeast Region 2

Robin Pascale: (A16, A31, A32) & NC only	1-4288	Robin.Pascale@assaabloy.com
--	--------	-----------------------------

Central Region 3

Joann Sierejko: (A21, A22)	1-5755	Joann.Sierejko@assaabloy.com
----------------------------	--------	------------------------------

International Companies

Luci Muzyk	1-6852	Luci.Muzyk@assaabloy.com
------------	--------	--------------------------

Customer Exceptions:

Joann Sierejko: All Akron, MidWest Wholesale DBA Banner Solutions

Shirley Sotaski: Builders Hardware & Doors Inc. DesMoines/Cedar Rapids

Anne Dempster: Himmels Hardware & Island Pacific, Doors Inc. Ft Dodge

Robin Pascale: Dugmore & Duncan, Doors Inc. Swaledale/Iowa City

Luci Muzyk: Doors Inc. Waterloo/Davenport

WHO'S WHO AT SARGENT

USA & Canada Prices Effective May 1, 2021

Telephone: 800-727-5477 • Fax Orders To: 800-906-6606**Master Key System's Support Fax: 888-898-8995****KEY DESIGN TEAM**

Birute Gelazauskiene – (Signature)	1-5786	Birute.Gelazauskiene@assaabloy.com
Lijana Mursko – (Conventional, Keso, Non, 24-Hour)	1-5558	Lijana.Mursko@assaabloy.com
Romas Sakalauskas – (KESO)	1-5625	Romas.Sakalauskas@assaabloy.com
Saulius Jovaisa – (Conventional, SFIC)	1-5722	Saulius.Jovaisa@assaabloy.com
Aurela Dautaj – (Canada Orders, Biting Lists)	1-5746	Aurela.Dautaj@assaabloy.com
Saulius Pleseckis – Key Edit	1-5767	Saulius.Pleseckis@assaabloy.com

MARKETING**Director of Marketing Communications**

Beth Welch	1-4263	Beth.Welch@assaabloy.com
------------	--------	--------------------------

Marketing Communications Manager – Electronic Access Control

Rebecca Samuel	1-4225	rebecca.samuel@assaabloy.com
----------------	--------	------------------------------

Product Marketing Manager – Decorative Hardware

Emily Charles	1-5682	Emily.Charles@assaabloy.com
---------------	--------	-----------------------------

Marketing Communications Specialist – Mechanical Products

Amy Esposito	1-5608	Amy.Esposito@assaabloy.com
--------------	--------	----------------------------

BRAND PROMOTIONS**Director of Business Development**

Dave Higginson	1-7216	David.Higginson@assaabloy.com
----------------	--------	-------------------------------

WHO'S WHO AT SARGENT

USA & Canada Prices Effective May 1, 2021

Telephone: 800-727-5477 • Fax Orders To: 800-906-6606
SALES SUPPORT SERVICES TEAM
Fax: 203-821-5729

Director of Strategic Pricing

Larisa Chavenello	1-3396	Larisa.Chavenello@assaabloy.com
Janice Shanley	1-6823	Janice.Shanley@assaabloy.com
Christine Le	1-5721	Christine.Le@assaabloy.com

TECHNICAL SUPPORT TEAM (Electronics)
Electro-mechanical and Electronic Access Control Products
Direct: 800-810-9473
Email: techsupport.sargent@assaabloy.com

EM Technical Support Team Leader

Gary Jacques	1-5920	gary.jacques@assaabloy.com
--------------	--------	----------------------------

EM Specialists (EAC Products)

Christina Berlingo Jonathan Brooks Shannon Carballo Valerie Espinal-Castillo Jacqueline Gonzalez Joseph Gonzalez	Alfred Gutierrez Nadia Morales Anthony Ruggiero Greg Stevens Matthew Van Rhyn Colin McNerney	800-810-9473	techsupport.sargent@assaabloy.com
---	---	--------------	-----------------------------------

TECHNICAL SUPPORT TEAM (Mechanical)
Mechanical Products 800-727-5477, Option 2
Email: techsupport.sargent@assaabloy.com

Mechanical Technical Support Team Leader

Gloria Dennis	Press 4	Gloria.Dennis@assaabloy.com
---------------	---------	-----------------------------

Exit Device Specialist **FAX: 203-821-5782**

<u>Main Contact:</u> Stephen Cibulas	Press 4	Stephen.Cibulas@assaabloy.com
--------------------------------------	---------	-------------------------------

Mortise Lock Specialist **FAX: 203-498-5567**

<u>Main Contact:</u> Paul Lichack	Press 3	Paul.Lichack@assaabloy.com
-----------------------------------	---------	----------------------------

<u>Main Contact:</u> Tino Bowden	Press 3	tino.bowden@assaabloy.com
----------------------------------	---------	---------------------------

Cylinders Specialist **FAX: 203-603-5921**

<u>Main Contact:</u> Rob Shanley	Press 5	Robert.Shanley@assaabloy.com
----------------------------------	---------	------------------------------

<u>Back Up:</u> Paul Lichack	Press 5	Paul.Lichack @assaabloy.com
------------------------------	---------	-----------------------------

Door Closer Specialist **FAX: 704-233-1582**

<u>Main Contact:</u> Mike Strickland	Press 7	mike.strickland@assaabloy.com
--------------------------------------	---------	-------------------------------

<u>Back Up:</u> Sean Medlin	Press 7	smedlin@nortondoorcontrols.com
-----------------------------	---------	--------------------------------

Bored Lock Specialist **FAX: 203-821-5768**

<u>Main Contact:</u> Donna McQuarrie	Press 2	Donna.McQuarrie@assaabloy.com
--------------------------------------	---------	-------------------------------

<u>Back Up:</u> Rob Shanley	Press 2	Robert.Shanley@assaabloy.com
-----------------------------	---------	------------------------------

**ORDERING AND SARGENT KEY SYSTEMS
SECURITY POLICY**

USA & Canada Prices Effective May 1, 2021

Order Types:

- Please submit **TURBOSHIP orders, Standard lead time(contract) orders, SPECIAL product orders** on separate order forms (Pages GI-27 – GI-30).
- Please use **TURBOSHIP** order forms for all **TURBOSHIP** orders. If you use your own purchase order forms, please supply the information in the proper SARGENT nomenclature, for your order to be processed without delay. Only products listed in the current **TURBOSHIP** brochure are available for **TURBOSHIP**. Products ordered that are not listed in the current **TURBOSHIP** brochure will automatically be entered at standard factory production lead times.
- Standard **Order Forms** are included in the 2021 Price Book and at www.sargentlock.com (Pages GI-27 – GI-30).
- **TURBO SHIP ORDER FORMS** are available on our website at www.sargentlock.com/turboship.html
- We recommend using **Order Forms** included with this Price Book when placing purchase orders for SARGENT products. The **Order Form** is available for copying prior to placing your order.

Orders with Quotes:

- If you have a **Quote**, please include a copy with the purchase order or reference the **Quote** number on **PAGE 1** of your order. Orders without this information may be delayed or may be subject to a \$100.00 price correction fee if invoiced incorrectly due to this missing information
- If you have a **Quote**, please check the expiration date. If the **Quote** is expired, please contact your DSS Sales rep. to find out how your quote can be re-instated. Orders received with expired **Quotes** may be delayed.
- If you have a **Quote**, please check products listed and packaging on the quote. Orders which do not match the products listed on your **Quote** or do not include all products listed on the **Quote** and do not have packaging (sister company order) information, may be delayed.

SARGENT Key Systems Security Policy:

The purpose of this security policy is to enforce our policies concerning high security, security and restricted keyway product, as well as master key system information. No master key system information or security related product is to be given or sold to anyone other than the facility owner through written correspondence. Verification must be submitted (fax copy will be acceptable) to SARGENT Key Records. The verification must be on the facility's letterhead and signed by a facility authorized systems administrator. SARGENT Key Records does not maintain "Letters of Authorization" on file. Each order must be accompanied by proper authorization. Only after the authorization has been verified will the order be processed for production. This security policy refers to the following:

- Signature systems • Protected keyway systems • Security cylinder systems

Also includes:

- Bitting information (even one bitting, absolutely no top-level master keys)
- Bitting lists (all formats; i.e., hard copy, disc)
- Key blanks and systems components

Please note:

- No orders are to be processed through SARGENT Key Records without proper authorization.

ORDERING TIPS & KEYING
– AUTHORIZATION DOCUMENTATION:

USA & Canada Prices Effective May 1, 2021

- Only orders with appropriate authorization attached will be given priority.
- Requests for systems information without proper authorization from the owner will be denied.
- Requests for information regarding the purchase of any systems support products as listed above will be referred to the local authorized sales agency.
- Refer to the current price lists for additional policies and procedures as they relate to this security policy.

Remember:

The purpose for the establishment of any security system is to provide an increased level of protection for the Facility owner.

Keying - Authorization Documentation:

When submitting purchase orders to SARGENT for processing, please remember that certain cylinder types and/or keyways require additional authorization documentation before the order can be entered.

Purchase orders will be held and questioned if the following keyway/cylinder types do not have the proper authorization documentation submitted with each purchase order or shipment of the following items will be made directly to the end user or their designated agent:

- All Restricted Keyway Cut Keys or Key Blanks;
- All Signature Cut Keys or Key Blanks;
- All XC Restricted Cut Keys or Key Blanks;
- All dimpled KESO keys;
- All clouds or downloadable versions for the Key Wizard Control Software and
- All key system biting information in either paper or electronic form

Exceptions:

- Standard key blanks and cut keys for the “C”, “H”, “L” and “R” keyway families
- XC key blanks and cut keys for any non-restricted keyway family

Any order or fax request received at SARGENT for any of the above products or information must specify the shipping address of that product or information as the end user of the product or information. If the product is to be shipped to the end user’s authorized agent, a letter authorizing that shipment to an address different than that of the end user must be on file at SARGENT or attached to the order.

If you have any questions regarding authorization, please do not hesitate to contact us or your local representative.

Purchase Order Format

For Comsense and Protech users please **use the Purchase Order Supporting (Detail) Schedule** to place contract orders, NOT the Door Index or Keying Index. Only the Purchase Order Supporting Schedule contains all of the information required, (options, item quantities) to properly furnish you materials.

For all other formats we ask that product of like nature be grouped together with the item quantities, Door Numbers, and keysets listed underneath or with the product. This will allow faster processing of your order.

Ordering Checklist:

Before placing your order, check for the following:

- ✓ Purchase order on company letterhead
- ✓ Purchase order is legible
- ✓ Purchase Order Number
- ✓ Account Number
- ✓ Ship To Address
- ✓ Contact Person for additional information requirements
- ✓ Pricing requirements – Buying Program or Quote
- ✓ TURBOSHIP order - TURBOSHIP order form OR clearly mark on your order form
- ✓ Contract Order (Keyed Lead Sheets attached)
- ✓ Authorization Letter **OR** Pin # (if applicable)
- ✓ Registry Number if Existing Key System or previous SARGENT order number
- ✓ Job Name
- ✓ Quantity
- ✓ Catalog Function
- ✓ Options (if applicable)
- ✓ Trim/Arm
- ✓ Finish (if applicable)
- ✓ Handing (if applicable)
- ✓ Backset & Strike (if applicable)
- ✓ Door thickness (if applicable)
- ✓ Door width & height – Exit Devices
- ✓ Voltage (if applicable)
- ✓ Keysets (if applicable)
- ✓ Door numbers (if applicable)

USA & Canada Prices Effective May 1, 2021

SARGENT Order Lead Sheet Check List

		Master Keyed Orders (including SKD type systems)		None Master Keyed Orders (Random, 1-bitted or None Keyed)	
		New System	Existing System		
Distributor Name		Required	Required	Required	
PO Number		Required	Required	Required	
Job Name, Address		Required	Required	Required	
Section #	Description				
1	System Status	Required	Required	Not required	
2	System Design	Required	Not required	Not required	
3	System Type	Required	Not required	Not required	
4	Key way	Required	Not required	If applicable	
5. AUTHORIZATION (depends on type and feature of system)	SARGENT Standard	i. <u>Conventional</u> Cyl. Features available: 21, 22***, 50, 51***, 63	Not required	Not required	Not required
		ii. <u>XC (11 Prefix)</u> Cyl. Features available: 21	Not required	Not required	Not required
		iii. <u>Restricted Keyways</u> (A, B, G, K, N, V) Cyl. Features available: 10, 11, 21, 22***, 50, 51***, 63	Has to be pre-approved by SARGENT Keying Department**	LOA or Ship Directly to End User	Same as Master keyed Orders
		iiii. <u>Signature (10 Prefix)</u> Cyl. Features available: 21, 63	Signature Agreement* with properly filled information	PIN Code or LOA with Authorized person Signature or Ship directly to End User	Same as Master keyed Orders
	SARGENT KESO Cyl. Features available: F1, 82, 83		KESO Signature Card*	KESO Forms* with Authorized person signature or Ship Directly to End User	Not Available
	SARGENT Degree Cyl. Features available: 21, 63		SARGENT Degree SID * with properly filled information	LOA and/or Security Codes or Ship Directly to End User	Not Available
	SARGENT SFIC	i. <u>Regular keyways: 4A</u> See Price Book for available competitors keyways Cyl. Features available: 11, 73	Not required	Not required	Not required
		ii. <u>Restricted Keyways: 4B</u> Cyl. Features available: 11, 73	Has to be pre-approved by SARGENT Keying Department**	LOA or Ship Directly to End User	Same as Master keyed Orders
6	Key Quantity	Required	Required	Required	
7	Cylinder Features <i>See General Section of Price Book for valid prefix combinations!</i>	If applicable	If applicable	If applicable	
8	Stamping Requirements	If not selected default stamping will be used			
9	Cross Keying	Required (If applicable)	Required (If applicable)	Not required	
10	Packing and Marking change keys	Required	Required	Required	
11 - 16	Shipping instructions	Required	Required	Required	
17	Bitting List	If applicable	If applicable	If applicable	
18	Contact	Required	Required	Required	

* - Can be found in SARGENT Price Book, General Information section or please contact Key Records (fax: 888-898-8995)

** - Prior order is placed all necessary information has to submit to SARGENT Key Records (fax: 888-898-8995) by DSS.

*** - 22 and 51 are only available for existing systems. 11&63, 10&11 are not valid combinations together.

SARGENT

ASSA ABLOY

USA & Canada Prices Effective May 1, 2021

SARGENT KEYED ORDER LEADSHEET SYSTEM INFORMATION (Section 1 - 5) <i>Every Purchase Order with keyed product requires Keyed Order Leadsheet</i>	
Distributor Name: _____	P.O. # _____
Job Name: _____	
End User: Name: _____	
Address: _____	
City: _____ State: _____ Zip: _____	
(1) SYSTEM STATUS (Master Keyed Orders Only)	
<input type="checkbox"/> New (SARGENT generated) <input type="checkbox"/> Field Specified Bittings <input type="checkbox"/> Existing. Please complete one of the following:	
If <u>New System</u> complete System Design Section 2 Field-Specified Bittings are attached? Registry Number*: _____	
<input type="checkbox"/> Yes <input type="checkbox"/> No TMK Bitting & Keyway: _____	
Previous SARGENT Order No*: _____	
*PLEASE NOTE: the Registry and/or Order Number is <u>ONLY</u> being used to help locate Key System data!!! For all other keying information, Sections 4 - 18 MUST be completed. We will not use the Registry/Order # to get this information In those instances when no information is provided default keyway, key quantities, stamping, packing etc will be applied to order.	
(2) SYSTEM DESIGN (New Systems ONLY)- Select Level & Indicate Future Requirements	
<input type="checkbox"/> Level 4 GGМК <input type="checkbox"/> Level 3 GMK <input type="checkbox"/> Level 2 MK	
# GM Per GGМК _____ # MK Per GGМК _____ # ChgKys Per MK _____	# MKS Per GMK _____ # ChKys Per MK _____
<input type="checkbox"/> 5-Pin System	<input type="checkbox"/> 6-Pin System (Default) <input type="checkbox"/> 7-Pin System
Additional Information (If Required)	
<input type="checkbox"/> SubMaster Keying Level Required: See Keying Notes Attached # of Sub Master Keys Per MK _____ # of Change Kys Per Sub Master _____	
<input type="checkbox"/> SKD's # of Different SKDs: _____	
(3) SYSTEM TYPE (New Systems ONLY)	
<input type="checkbox"/> Conventional (Sargent Std) <input type="checkbox"/> Degree <input type="checkbox"/> KESO <input type="checkbox"/> SFIC (Best) Check One Below	
Note: Select Cylinder Features In Section 7 (Page 2) <input type="checkbox"/> A2 <input type="checkbox"/> A4	
(4) KEY WAY	
Keyway Selection: SARGENT Manufacturing will assign keyways unless specified otherwise below.	
<input type="checkbox"/> Customer Specified Keyway _____	
Use of Restricted Keyways (A, B, G, V, K, N and 4B) have to be pre-approved by SARGENT Key Records.	
(5) AUTHORIZATION	
Signature/Degree/KESO/Restricted Keyway products requires Authorization	
Degree/Signature ID Code: _____ Zip Code (Signature Only): _____	
Security/PIN Code: _____	
Request Form Att'd For NEW Degree/Signature Code <input type="checkbox"/> Yes <input type="checkbox"/> No	
Letter of Authorization Attached:	Degree: <input type="checkbox"/> Yes <input type="checkbox"/> No Signature: <input type="checkbox"/> Yes <input type="checkbox"/> No KESO: <input type="checkbox"/> Yes <input type="checkbox"/> No Restricted: <input type="checkbox"/> Yes <input type="checkbox"/> No
NOTE: Letter Of Authorization is required if order is not shipping direct to end user	

USA & Canada Prices Effective May 1, 2021

SARGENT KEYED ORDER LEADSHEET			
THIS ORDER ONLY (Section 6 - 9)			
(6) KEY QUANTITY		(7) CYLINDER FEATURES	
<input type="checkbox"/> GGМК		<u>Qty</u>	
<input type="checkbox"/> GМК)	<u>Designation</u>	<u>Qty</u>	<input type="checkbox"/> Signature (10-)
	_____	_____	<input type="checkbox"/> Removable Core (63-,6300)
	_____	_____	<input type="checkbox"/> XC (11-)
	_____	_____	<input type="checkbox"/> Interchangeable Core (73-,7300B)
<input type="checkbox"/> Master Key	<u>Designation</u>	<u>Qty</u>	<input type="checkbox"/> Construction Lost Ball (21-)
	_____	_____	<input type="checkbox"/> Construction - Split Key (22-)
	_____	_____	<input type="checkbox"/> Bored Hotel - 10G50 (N/A with 10-, 11-, 21-, 22-, DG2 and DG3)
	_____	_____	<input type="checkbox"/> Mortise Hotel - 8250 (N/A with 10-, 11-, 21-, 22-, DG2 and DG3)
	_____	_____	<input type="checkbox"/> Old Style Removable Core (51-)
<input type="checkbox"/> Sub Mstr Key	<u>Designation</u>	<u>Qty</u>	<input type="checkbox"/> KESO (82-)
	_____	_____	<input type="checkbox"/> KESO Removeable Core (83-)
	_____	_____	<input type="checkbox"/> KESO (F1-)
<input type="checkbox"/> Other	<u>Designation</u>	<u>Qty</u>	<input type="checkbox"/> DEGREE (DG1-)
	_____	_____	<input type="checkbox"/> DEGREE (DG2-)
	_____	_____	<input type="checkbox"/> DEGREE UL437 (DG3-)
<u>Special Keys</u>		<u>Qty</u>	
<input type="checkbox"/> Control Keys		_____	
<input type="checkbox"/> Construction MstrKeys		_____	
<input type="checkbox"/> Emergency Keys		_____	
Change Keys (Two cut keys are standard per lockset/cylinder)			
<input type="checkbox"/> Keys Per Cylinder (Each)		<u>Qty</u>	
<input type="checkbox"/> Keys Total	Symbol: _____	<u>Qty</u>	
<input type="checkbox"/> Add'l Notes Attached	_____	_____	
Note: See General Section of Price Book for valid prefix combinations!			
(8) STAMPING REQUIREMENTS - Default stamping will apply unless specified otherwise			
Select one ONLY what to use as VKC symbol		Select one ONLY what to use for VKC location	
<input type="checkbox"/> Bittings		<input type="checkbox"/> Stamp Keys Only	
<input type="checkbox"/> Keyset symbols		<input type="checkbox"/> Stamp Keys and Cylinder Concealed	
<input type="checkbox"/> Alternate non DHI symbols		<input type="checkbox"/> Stamp Keys and Cylinder Face - N/A with SFIC, Degree, KESO, 10- and 11-	
<input type="checkbox"/> No Bittings or Keysets on keys - additional charges will apply		<input type="checkbox"/> No SARGENT Logo On Keys - additional charges will apply	
<input type="checkbox"/> No Keyway on Keys - additional charges will apply		<input type="checkbox"/> No SARGENT Logo On Cylinders - additional charges will apply	
<input type="checkbox"/> Stamp Keys "DO NOT DUPLICATE" - No Charge		<input type="checkbox"/> New Die Stamp	<input type="checkbox"/> Existing Die Stamp - No Charge
<input type="checkbox"/> Die Stamping - If Selected, identify if Existing or New			
Die Stamp Text: _____			
(9) CROSS KEYING			
Key Symbol:	To Be Operated By		
_____	_____		
_____	_____		
_____	_____		
_____	_____		
<input type="checkbox"/> Add'l Notes Attached			
Note: Cross Keying minimizes cylinder security level and are not recommended by SARGENT manufactory!			

SARGENT®

ASSA ABLOY

USA & Canada Prices Effective May 1, 2021

SARGENT KEYED ORDER LEADSHEET	
THIS ORDER ONLY (Section 10 - 18)	
	P.O. # _____
10) PACKING INSTRUCTIONS FOR CHANGE KEYS	
<input type="checkbox"/> Pack Change Keys With Locks (Standard) <input type="checkbox"/> Pack Change Keys separately - See Price Book	
11) SHIPPING INSTRUCTIONS FOR CHANGE KEYS	
Ship Change Keys To: _____ _____ Attention: _____	
12) SHIPPING INSTRUCTIONS FOR MASTER KEYS	
Ship Master Keys To: _____ _____ Attention: _____	
13) SHIPPING INSTRUCTIONS FOR KEY BLANKS	
Ship Keyblanks To: _____ _____ Attention: _____	
14) SHIPPING INSTRUCTIONS FOR CORES	
Ship Cores To: _____ _____ Attention: _____	
15) SHIPPING INSTRUCTIONS FOR KEY WIZARD SOFTWARE	
Ship Keywizard Software To: _____ _____ Attention: _____	
<input type="checkbox"/> Registration Form Att'd (Required)	
16) SHIPPING INSTRUCTIONS FOR CONSTRUCTION KEYS	
Ship Construction Keys To: _____ _____ Attention: _____	
17) SHIPPING INSTRUCTIONS FOR BITTING LIST	KEYWIZARD DOWNLOAD DISC
<input type="checkbox"/> Only Keysets that are ordered with product on this PO (N/C) <input type="checkbox"/> Expanded Bitting List (Please provide requirements) <input type="checkbox"/> Provide on Disc <input type="checkbox"/> Provide on Paper Ship to: _____ _____ Attn: _____	<input type="checkbox"/> Keywizard Download File on Disc Ship to: _____ _____ Attn: _____
Note: Please see Price Book page CK-4 for prices and additional information regarding above items	
Expanded Bitting List requirements:	

18) CONTACT INFORMATION - Name of individual in your organization who is knowledgeable about this project should any clarification be necessary.	
_____ Name: _____ _____ Phone #: _____ Fax #: _____ _____ Email: _____	

USA & Canada Prices Effective May 1, 2021

Door Closers		PAGE _____ OF _____
CUSTOMER ORDER NO	SHIP VIA	
NAME	TO:	DATE
CITY	STATE	ORDER NO
STATE	ZIP CODE	CUST CODE
JOB NAME	MARK SHIPMENT	
FOR CLOSERS USED WITH OVERHEAD HOLDERS OR WITH MOUNTING PLATES, REFER TO CATALOG AND FURNISH COMPLETE ORDERING INFORMATION. LIST A SEPARATE ITEM FOR EACH HAND CLOSER. DO NOT ORDER "R" OR "L" CLOSERS ON THE SAME LINE.		
TOTAL QTY	PREFIXES	DOOR CLOSER NO.
	HAND	TYPE OF ARM
	L R	FINISH
		TB & GN
		TYPE OF OVERHEAD HOLDER
		ADDITIONAL INFORMATION
	ITEM QTY	ITEM NO DOOR NO

**SARGENT *Signature* Series
Code Pattern Registration Form**

100 Sargent Drive New Haven, CT 06511 Phone 800-727-5477 Fax 888-898-8995

Section A Distributor Information

(1) Date:

(2) Distributor Name:

(3) Account Number:

(4) City:

(5) State:

(6) Zip Code:

(7) Contact Name:

(8) Phone:

(9) Fax:

Section B Facility Information:

(10) Facility Name:

(11) Building Name:

(12) Address:

(13) City:

(14) State:

(15) Zip Code:

(16) Area Responsible for Key System:

And Names
Of Authorizing
Individuals

Title:

Title:

Mailing Address:

City:

State:

Zip:

Phone:

Fax:

Section C: System Specifications:

Existing System

New System

Cylinder Quantity:

Existing Registry Number:

Requested Keyway:

System Level:

Construction Keying

Removable Core

Hotel Mky

Section C: Area of Exclusivity:

State

Adjacent States

Additional States:

Final Approval and Assignment by SARGENT

Factory Use Only:

Keyway Family: _____

Signature Code _____ PIN Code _____ Zip: _____

Alternate Code _____



SARGENT®

ASSA ABLOY

USA & Canada Prices Effective May 1, 2021

AUTHORIZED SIGNATURE FORM SARGENT KESO SECURITY SYSTEM										
Register No: <input type="checkbox"/> Keso F1 <input type="checkbox"/> Keso (<i>Standard</i>)	<table style="width: 100%; border-collapse: collapse;"> <tr> <td style="width: 50%;">Job:</td> <td style="width: 50%;"></td> </tr> <tr> <td>Address:</td> <td></td> </tr> <tr> <td>Distributor:</td> <td></td> </tr> <tr> <td>Address:</td> <td></td> </tr> </table>		Job:		Address:		Distributor:		Address:	
Job:										
Address:										
Distributor:										
Address:										
PERSON(S) AUTHORIZED TO ORDER ADDITIONAL LOCKSETS, CYLINDERS OR KEYS										
Signature	Title	Name (please type or print)								
Signature	Title	Name (please type or print)								
Signature	Title	Name (please type or print)								
Company Affiliation										
Address										
SARGENT Manufacturing Company • 100 Sargent Drive • P.O. Box 9725 • New Haven, CT 06536-0915 Phone: 800-727-5477 • Fax: 888-863-5054 • Website: www.sargentlock.com SARGENT of Canada • Phone: 905-940-2040 • Fax: 905-940-3242 • Website: www.sargentcanada.ca										
An ASSA ABLOY Group company	ASSA ABLOY									

USA & Canada Prices Effective May 1, 2021

**AUTHORIZATION FORM
SARGENT KESO SECURITY SYSTEM**



Keso F1 Keso (*Standard*)

Date:	
Distributor Purchase Order No	

TO					
Distributor Name:					
Address:					
City:		State:		Zip:	

Following to be completed by owner of system

FROM					
Name:					
Company:					
Address:					
City:		State:		Zip:	
Printed Name					
Authorized Signature <i>(Must match signature on file)</i>					

PLEASE RETURN SIGNED FORM AND ORDER TO DISTRIBUTOR. DO NOT MAIL DIRECT TO SARGENT MANUFACTURING COMPANY.

THIS IS TO AUTHORIZE SARGENT MANUFACTURING COMPANY TO ACCEPT YOUR ORDER FOR LOCKSETS OR CYLINDERS KEYED TO SYSTEM ESTABLISHED FOR:

Job Name:					
Company:					
Address:					
City:		State:		Zip:	

SARGENT Manufacturing Company •100 Sargent Drive •P.O. Box 9725 •New Haven, CT 06536-0915
Phone: 800-727-5477 •Fax: 888-863-5054 •Website: www.sargentlock.com
SARGENT of Canada •Phone: 905-940-2040 •Fax: 905-940-3242 •Website: www.sargentcanada.ca

An ASSA ABLOY Group company

ASSA ABLOY

SARGENT®

ASSA ABLOY

USA & Canada Prices Effective May 1, 2021

**24 HOUR KEY ORDER
SARGENT KESO SECURITY SYSTEM**



Keso F1 Keso (Standard)

For internal use only, do not write in spaces below

Territory:	
Order No:	
Customer Code No:	

Invoice To			
Ship To:	<input type="checkbox"/> Distributor	<input type="checkbox"/> System Owner	
Distributor Name:			
Address:			
City:	State:	Zip:	

Following to be completed by owner of system

System Owner			
Attention:			
Company:			
Address:			
City:	State:	Zip:	
Owner Order No:	Date:		
Printed Name			
Authorized Signature (Must match signature on file)			

Quantity of Keys	Key Numbered as Stamped on Key (i.e. A1234 B1234) (Number must be specified) (Use one line per key change)	Other Information

*For next day shipping orders must be for less than 25 keys and be received by 10:00 am EST

SARGENT Manufacturing Company •100 Sargent Drive •P.O. Box 9725 •New Haven, CT 06536-0915
Phone: 800-727-5477 •Fax: 888-863-5054 •Website: www.sargentlock.com
SARGENT of Canada •Phone: 905-940-2040 •Fax: 905-940-3242 •Website: www.sargentcanada.ca

An ASSA ABLOY Group company

ASSA ABLOY

USA & Canada Prices Effective May 1, 2021

Degree™ System Information Document

System: _____ DG1 _____ DG2 / DG3

NOTE: System Information Document required for all new systems; see reverse for additional document requirements.

Facility Name: _____

Mailing Address: _____

Shipping Address: _____

City: _____ State: _____

City: _____ State: _____

Zip Code: _____

Zip Code: _____

Phone: (____) _____

Fax: (____) _____

E-Mail: _____

By: _____
(Print Name, Primary Systems Administrator) (Title) (Authorized Signatures)

I understand that if any of the authorized representatives of this Facility (as set out below) are removed from their duties for any reason whatsoever, it is my responsibility to notify Sargent Key Records Department, in writing, of their release and the names of their replacements.

Date: _____

Authorized Facility Representatives (Printed Name)	(Title)	(Authorized Signatures)
_____	_____	_____
_____	_____	_____
_____	_____	_____

Please attach any additional.

_____ (Signature or Initial by System Administrator Only)

"OPT-OUT" Option (System Type DG2 & DG3 Only): By selecting this option I elect not to use the sequentially numbered registrations certificates and agree to substitute them with a Letter of Authorization.

SARGENT[®]**ASSA ABLOY**

USA & Canada Prices Effective May 1, 2021

Degree DG1 Required Administrative Documents:

- Mandatory: all new systems will require a completed System Information Document (orders can not be entered without this document). The fully executed original document will be kept on file at Sargent Manufacturing.
- Subsequent order requirement. A letter of authorization will be required if the product is shipped to an address other than what's recorded on the System Administration Document, and/or if the address on the purchase order is different than what is listed on the System Information Document.

Degree DG2 & DG3 Required Administrative Documents:

- Mandatory: all new systems will require a completed System Information Document (orders can not be entered without this document). The fully executed original document will be kept on file at Sargent Manufacturing.
- Subsequent order requirement: A specific randomized security code will be required for each order unless "Opt-Out" has been authorized by the systems administrator.
- If the "Opt Out" option is **NOT** selected
 - A correct system specific (randomized) security code must be included with each subsequent order.
 - Security codes are specific to each order.
 - If the shipping address is other than the one listed on the System Information Document, a Letter of Authorization signed by one of the recorded authorized representatives of the facility is required.
 - Letter of Authorization must contain the same shipping address that appears on the customer's Purchase Order.
 - Letters of Authorization will not be kept on file at factory.
 - Without the proper security code, Letter of Authorization, or if the shipping address is other than what's listed on the System Information Document, the order cannot be processed.
- If the System Administrator elects not to use security codes as part of the authorization process, the "Opt Out" option can be authorized by the system administrator.
 - If the "Opt Out" option is **S** selected
 - A system-specific security code is not required.
 - Letter of Authorization must be signed by one of the facility's authorized representatives. If the shipping address is other than the one listed on the System Information Document, a Letter of Authorization will be required.
 - Letter of Authorization must contain the same shipping address that appears on the customer's Purchase Order.
 - Letters of Authorization will not be kept on file at factory.

CYLINDERS AND KEYING

How to Order/Key Control System Types	CK-1
Key Control System Types/ Old Style/LFIC/SFIC Temporary Construction Cores	CK-2
Keying Charges.....	CK-3
Key Charts/Key Wizard Software.....	CK-4
Mortise & Rim Cylinders.....	CK-5
Cylinders & Accessories	CK-6
Bored Lock Cylinder & Parts.....	CK-7
XC Series	CK-8
XC Series	CK-9
SARGENT Large Format Interchangeable Core Cylinders & Old Style Removable Core Cylinders	CK-10
SARGENT XC - Large Format Interchangeable Core Cylinders.....	CK-11
Small Format Interchangeable Core	CK-12
XC - Small Format Interchangeable Core.....	CK-13
Keying Kits, Tools, Gauges, Components	CK-14
Keyblanks.....	CK-15
Keyblanks.....	CK-16
SARGENT Cut Keys/Competitor Keyways	CK-17
KESO F1 Security System Options	CK-18
KESO F1 Security System Cylinders.....	CK-19
KESO F1 Security System Cylinders/Padlocks	CK-20
KESO F1 Security System UL Listed Cylinders/Cam/Padlocks	CK-21
KESO F1 Security System Cylinders Guarantee.....	CK-22
KESO Security System Options.....	CK-23
KESO Security System Cylinders	CK-24
KESO Security System Cylinders/Padlocks.....	CK-25
KESO Security System UL Listed Cylinders/Cams/Padlocks	CK-26
KESO Security Systems Cylinders Guarantee	CK-27
Signature Series Cylinders & Keying	CK-28
Signature Series Removable Core.....	CK-29
Signature Series Mortise & Rim Cylinders.....	CK-30
Signature Series Bored Lock Cylinders & Parts	CK-31
Degree Keying Chares.....	CK-32
Degree DG1 Cylinders	CK-33
Degree DG1 LFIC and DG2 Cylinders.....	CK-34
Degree DG2 Cylinders and LFIC Cylinders	CK-35
Degree DG3 Clinders.....	CK-36
Degree DG3 LFIC Cylinders	CK-37
Degree DG3 Degree Pins and Parts.....	CK-38

How to Order

Step	Description	Example
Quantity	Each	1 Ea
Option	Consult catalog for options available	1 Ea. 63-
Product Series	Consult catalog for applicable product	1 Ea. 63-8205 LNL
Finish	Consult catalog for finishes available	1 Ea. 63-8205 LNL US26D
Keying	DHI keying nomenclature	1 Ea. 63-8205 LNL US26D AA1

To establish a new factory master key system or to add to an existing factory master key system please use the NEW ORDERING INFORMATION LEAD SHEET.

For all master keyed systems of a level 5 or above, please consult factory before ordering for information on how to order.

Key Control System Types

Type	Description	Option
Stock Keyway (LA)	LA keyway will be provided on non-masterkeyed order if no keyway is provided.	-
Standard	Keyways in general use for key systems.	-
Restricted (Not Published)	Keyways tightly controlled by the factory, letter of authorization required from end user for keys & cylinders, and prior approval from the SARGENT Security Systems Manager before establishing a new system.	-
Large Format IC Core (R Series Standard-for New Systems)	System allows for increased security through quick changing of cylinder into reserve or into another lock. System can be used with mortise locks, bored locks, auxiliary deadlocks, padlocks and exit devices.	63 64 Construction Core
Small Format Interchangeable Core	System allows for increased security through quick changing of core into cylinder housing or into another lock. System can be used with mortise locks, bored locks, auxiliary locks, and exit devices. Available in SARGENT 4A & 4B keyway family & existing competitor keyway families.	72 Construction 73 (6-Pin) 73-7P (7-Pin)
XC	Patented product that cannot be copied and supplied by others. Provides an intermediate level of control by ensuring that the keyblanks are not readily available in the market. Offered in many of SARGENT's standard keyways and is readily integrated as a cost-effective means of achieving higher security key control in an existing key system. Available in SARGENT standard or 7 Pin Small Format (4A and restricted keyway 4B) Interchangeable Core cylinders and Sargent Large Format Interchangeable Core.	11
Signature	Signature codes tightly controlled by the factory. Pin # or explicit letter of authorization required from the end user for keys & cylinders. New code assignments require form H759 "Code Pattern Registration Form" to establish Signature Code and keyway assignments. Available with construction keying and removable core options (as additions). When Signature and Standard keys are used on the same system, miscellaneous charges and substitution prices that apply to Signature will apply to Standard.	10
KESO	KESO codes tightly controlled by the factory. End users signature required for keys & cylinders. Please contact factory for approval BEFORE establishing any new KESO system. All keying and key cutting performed in a factory secure area.	82 83 Removable Core 84 Construction Core
KESO F1	KESO F1 Series of cylinders incorporates the same time proven KESO product line and includes advanced Patented features. These features to both cylinder and key are designed to be used in new Patented cylinders and are compatible with existing KESO key systems. KESO F1 codes tightly controlled by the factory. End users signature required for keys & cylinders. All keying and key cutting performed in a factory secure area.	F1-82 F1-83 Rem. Core 84 Construction Core
Bump Resistant	Patent Pending bump resistant cylinders. These cylinders employ especially engineered patent pending pinning components designed to resist bumping while maintaining the cylinder's strength. Not available with 10, 22, 30, 60, 63, 64, 70, 72, 73, 737P, KESO, SC, SE options.	BR

CK-2 CYLINDER & KEYING



USA & Canada Prices Effective May 1, 2021

Key Control System Type	Description	Option
Degree DG1	Patented Key Control features a utility patented keyway and is constructed to provide DG1 protection against bumping for mortise, rim and component fixed cylinders. These cylinders easily retrofit into existing hardware.	DG1
Degree DG2	Patented Key Control Integrated with Security Protection combines a utility patented keyway and patented side bar locking with unique angled bottom pins that provide end users with geographical exclusivity. Cylinders are constructed to provide protection against bumping and picking. Because of its superior key control, patent protection until 2027, and physical strength, we recommend SARGENT DG2 products to be used in conjunction with the DG3 for new installations or when retrofitting systems, including large format interchangeable core systems.	DG2
Degree DG3	High Security with Patented Key Control is our premier brand technology. Degree DG3 combines a utility patented keyway and side bar locking with unique angled bottom pins that provide end users with geographical exclusivity. These cylinders have earned a UL437 Listing, the ANSI/BHMA A156.5 Grade 1 certification, and are classified as high security because of their superior resistance to physical attack and protection against unauthorized key duplication. Because of its superior key control, patent protection until 2027, and physical strength, we recommend SARGENT DG3 products for new installations or when retrofitting systems, including large format interchangeable core systems.	DG3

OLD STYLE REMOVABLE TEMPORARY CONSTRUCTION CORES	Price/Brass Core
(52-)	\$85.00

Number	Description	Price
252CMK	Old Style Temporary Construction Master Key - 5 pin (52-)	\$9.00
252CTL	Old Style Temporary Construction Control Key - 5 pin (52-)	
6252CMK	Old Style Temporary Construction Master Key - 6 pin (52-)	
6252CTL	Old Style Temporary Construction Control Key - 6 pin (52-)	

LFIC/SFIC TEMPORARY CONSTRUCTION CORE	Price/Brass Core
6400 - 6 pin core only, 64-, 1164-, DG1, 2, 3, 64-	\$83.00
7200 - 7 pin core only, 72-, 11-72-, 11-7P-7200	\$75.00

HOW TO RETURN ABOVE CONSTRUCTION CORE

The full invoice must be paid according to SARGENT's standard terms. The brass construction cores, 6-construction day keys, and 1-control key will be packed together and will ship with the order, unless otherwise specified

Contact your Customer Service Representative for a Returned Goods Authorization. Provide the factory order number and year of the original order. Credit is issued for all cores returned in good operating condition at the time of the original order. Applicable discounts to the original unit are applied to the returned core.

Number	Description	Price
6251CMK	Temporary Construction Removable Core Master Key - 6 pin used with 64-, 11-64-, DG1-64, DG2-64, and DG3-64	\$9.00
6251CTL	Temporary Construction Removable Core Control Key - 6 pin used with 64-, 11-64-, DG1-64, DG2-64, and DG3-64	
6282BCMK	Construction Interchangeable Core Master Key - 6 pin used with 72-	
6254BCTL	Construction Interchangeable Core Control Key - 6 pin used with 72-	
7282BCMK	Construction Interchangeable Core Master Key - 7 pin used with 11-72-	
7254BCTL	Construction Interchangeable Core Control Key - 7 pin used with 11-72-	

Experience a safer
and more open world

Copyright © 2002-2021 Sargent Manufacturing Company, an ASSA ABLOY Group company. All rights reserved. Reproduction in whole or in part without the express written permission of Sargent Manufacturing Company is prohibited. Contact us at: 800-727-5477 or visit www.sargentlock.com. In Canada contact us at: 800-461-3007 or visit www.assaabloydss.ca

Note: The below applies to Standard Key Systems.
 For XC Series refer to CK-8 .
 For Large Format Interchangeable Core refer to CK-12
 For Large Format XC Interchangeable Core refer to CK-13
 For Small Format Interchangeable Core refer to CK-12
 For Small Format XC Interchangeable Core refer to CK-13
 For KESO F1 refer to page CK-18 .
 For KESO refer to page CK-23 .
 For Signature refer to page CK-28 .
 For Degree refer to page CK-32
 SARGENT keyed orders should include Keying Lead Sheet.

Keying Charges & Substitutions	Price
Cylinder Service Fee (applies to cylinders and cores <u>not</u> being installed in ASSA ABLOY products)	Consult Factory
*Masterkeying or Higher level of keying, any quantity	
Masterkeying or Higher level of keying, any quantity, cylinders only	Add \$16.00 /cyl.
*Construction Masterkeying with lockset or exit devices (21-, 22-)	
Construction Masterkeying with cylinders only (21-, 22-)	
Extra Keys (Cylinders are packed standard with 2 change keys each)	
For each extra key ordered with locksets, exit devices or cylinders	\$5.00 /key
For keys packed separately (Indicate appropriate "ship to" address on keying cover sheet)	Add \$4.00 /cyl.
Key Marking	
"Do Not Duplicate" or other stamps on file at SARGENT	No Addition
Where new special stamp is required e.g., "State of Alaska - Do Not Duplicate" Extra lead time required	Add \$840.00 /die
Keys stamped from this special die on first only	Add \$4.00 /key
Visual Key Control	
Stamping of biting numbers on Change/Day keys standard	N/C
Stamping of keyset number and file number on Master keys standard	N/C
Stamping of cylinder plug and/or two keys with industry standard alpha numeric keyset symbol	Add \$8.00 /cyl.
Each additional key	\$1.00 /key
Concealed stamping code (Keyset Symbol) on bored, mortise or rim cylinder slide	Add \$8.00 /cyl.
Concealed stamping of 6300/10-6300 and old style Cores slide	Add \$8.00 /cyl.
Note: Not available with and XC plugs/bodies or signature plugs	
Delete SARGENT Logo or delete biting or key set cylinder and or keys (Consult factory for additional cost and leadtime)	
*To delete keyway from key per keyway	\$4.00 / key
**To delete logo from cylinder or key - Specify which or both	\$4.00 /cyl. or key
To delete biting and key set from keys	\$4.00 per key plus set up charge
*Set-up charge to delete keyway from key per keyway per order	\$103.00
**Set-up charge to delete logo from cylinder or key	\$103.00
Note: Not available with SFIC, XC, KESO, & Degree	
All orders will continue to be handled as a "special" when ordered. Discounts do not apply.	
SARGENT Restricted Keyway Family (A, B, G, K, N, V) 6 Pin, (4B) Small Format Interchangeable Core 7Pin	
Locksets, cylinders and cores with restricted sections	Add \$7.00 /cyl.
Cylinder barrels for restricted keyways	Add \$7.00 /bar.

NOTES: All orders for restricted keyblanks, barrels, or product containing cylinders that have a restricted keyway must include a letter of authorization or a copy of purchase order from the end user. Prior authorization from SARGENT key systems is required before establishing a new key system that requires a restricted keyway. Contact SARGENT key records to determine size of biting list.
 U&R keyways available 1 bitted.

Two (2) cut change keys are provided per lockset or cylinder at no charge. Keyblanks cannot be substituted for cut keys. Double cylinder lockset when keyed alike on both sides receives 2 keys per lock.

CK-4 CYLINDERS & KEYING

SARGENT®

KEY CHARTS/KEY WIZARD

ASSA ABLOY

USA & Canada Prices Effective May 1, 2021

# Bittings	Paper	Disc	Keywizard	Disc Price	Keywizard Price	Paper Price
1-50	KC1	KCD1	DLKW1	\$227.00	\$302.00	\$377.00
51-200	KC2	KCD2	DLKW2	\$347.00	\$422.00	\$497.00
201-1000	KC3	KCD3	DLKW3	\$465.00	\$540.00	\$615.00
1001-3000	KC4	KCD4	DLKW4	\$586.00	\$661.00	\$736.00
3001-6000	KC5	KCD5	DLKW5	\$679.00	\$754.00	\$829.00
6001-9000	KC6	KCD6	DLKW6	\$1,018.00	\$1,093.00	\$1,168.00
Over 9000	KC7	KCD7	DLKW7		Consult Factory	

Note: Bitting Lists (a.k.a. Keycharts) requested for keysets ordered *with* factory keyed product for either a new or existing system will be provided at no charge, except for Keywizard DLKW1 thru DLKW7

- Additional Bittings or P.O.'s for Bitting Lists Only – **EXISTING MASTER KEY GROUPS**
Up to 10 **total** for keysets tied to **existing** master key groups will be provided at no charge
11 or more bittings will be charged per above chart
- Additional Bittings or P.O.'s for Bitting Lists Only – **NEW MASTER KEY GROUPS**
Regardless of the quantity being requested, will be charged per above chart

These prices are for a hierarchical Master Key system with no cross-keying of selected keys.

For special requirements or for systems prior to 1997, consult factory for a quote.

An owner's letter of authorization must be attached to all purchase orders for additions to existing systems.

SARGENT is not liable for cylinders pinned incorrectly in the field.

Key Wizard Software		Price
Catalog #	Description	
KW-SS1	Single license version	\$1,342.00
KW-SSN1	Network version	\$1,577.00
KW-DEMO1	Demonstration version	\$42.00
UP-KW-SSN1	Keywizard upgrade from Single Site Version to Network Version**	\$810.00

** Please consult factory for the availability of existing systems for use with Key Wizard products.

Note: First year of maintenance and technical support is included on ALL Key Wizard products

See catalog for system requirements

Key Wizard order form is available online through the ASSA ABLOY Door Security Solutions Extranet:
www.assaabloydss.com

Contact SARGENT key records to determine size of bitting list

USA & Canada Prices Effective May 1, 2021

Note: Assembled Mortise & Rim cylinders include #97 Rosette are available in US3, 4, 9, 10, 10B, 10BE, 10BL, 14, 15, 20D, 32, 32D, BSP, and WSP finishes. Cylinder plugs/barrels will be in either US4 or 15. Specify finish when ordering.
 Note: 6-Pin standard; 7-Pin available in #34 and size 42 and larger. Specify "7-Pin" when 7 Pin cylinders are needed and provide keying details.

Rim & Mortise Cylinder Numbers	Specify Finish/Price
34 (Rim), 41, 42, 43, 44, 46 (Mortise)	\$96.00
48, 50, 52, 54	\$141.00
56	\$345.00

Note: Optional Cylinder Rosette: 1KB-1, 1KB-2, 1KB-3 are to be ordered and charged separately. Consult individual product catalogs for size.

Mortise Cylinders with following Suffix Cam No.		
101*	Adams Rite 1850, 4700	
105	Short Cams I/S 78/82 (16 & 92) functions	
106*	Schlage L	No Addition
112	"Open" Misc. – Wide Straight Cam	
113*	4370 Key Switch Cam	
115	SARGENT Hotel (50-) Cam – for 50-40 Series Cylinders	

*For removable core cams, see CK-10 .

Hotel Type Mortise Cylinders – Consult Factory for existing system compatibility	Specify Finish/Price
50-42, 50-43, 50-44 Hotel Cylinder (7850, 8250 only)	\$127.00

Mortise Cylinders, Exposed Barrel Only	Specify Finish/Price
78-41 Thru 78-43 (only available in Std, 10-, 21-, and 22- options)	\$127.00

Mortise Cyl. Plug No.	Plugs Cylinder Size	6-Pin US4 & 15 Finish Price
13-0401	41	
13-0402	42	
13-0403	43	\$32.84
13-0404	44	
13-0405	46	
13-0406	48	
13-0407	50	
13-0408	52	\$49.28
13-0409	54	
13-0474	56	

Mortise Cyl. Body No.	Cyl. Body No. Cylinder Size	Specify Finish Price
13-2005	41	
13-2006	42	
13-2007	43	\$48.78
13-2008	44	
13-2009	46	
13-2010	48	
13-2011	50	
13-2012	52	\$70.31
13-2013	54	
13-2382	56	

Slide Only – for Mortise & Rim Cylinders (100/pack)		Price/Pack
13-0779	6-pin made before 5/08	\$43.70
13-0780	7-pin made before 5/08	\$54.63
13-1341	6-Pin Slide for 6300 made after 4/06 w/o box logo. Also on rim/mortise cylinders after 6/08	\$43.70
13-1797	7-Pin Slide made after 6/08	\$86.03

Mortise Cams		
Part #	Minimum Quantity 25 ea.	Price
13-0097	"Open" Misc. Wide Straight Cam	
13-0664	Standard	\$5.44
13-0665	Short Cam – I/S 78/82 (16 & 92) Functions	
* 13-0512	Adams Rite (1850, 4700)	
* 13-0921	For 4370 Key Switch Coverleaf Cam	\$8.14
13-2045	SARGENT Hotel (50-) Cam for 40 Series Cyls.	
* 13-0938	For Schlage L	
01-1121	Cam Screws (Price/Pack - 100 cams)	\$31.40

Rim Cylinder Parts		Specify Finish
13-0090	6 Pin Cylinder Plug	\$32.84
13-0587	7 Pin Cylinder Plug	\$32.84
13-2005	6 Pin Cylinder Body & Slide	\$48.78
13-2712	7 Pin Cylinder Body & Slide	\$48.78
13-0074	Connecting Screws 2-1/8"	\$0.73
13-0080	Plug Retainer	\$1.71
13-0085	Connecting Bar 2-1/2"	\$1.71
13-0086	Rim Cylinder Back Plate	\$2.50
13-0075	Connecting Screws 2-3/4"	\$1.88

* See CK-7 for removable core cams.

CK-6 CYLINDERS & KEYING

SARGENT®

CYLINDERS & ACCESSORIES

ASSA ABLOY

USA & Canada Prices Effective May 1, 2021

Note: Mortise & Rim cylinders are available in US3, 4, 9, 10, 10B, 10BE, 10BL, 14, 15, 20D, 32, 32D, BSP, WSP finishes.
Cylinder plugs/barrels will be in either US4 or 15. Specify finish when ordering.

Cylinder Rings		Price Per Each Piece
Number	Description	03/04/09/10/10B/10BE/10BL/14/15/20D/26/26D/32/32D/BSP/WSP
90	1/16", 1/8", 3/16", 1/4", 3/8" (Blocking Rings)	\$8.55
97	9/32" (Rosette) – standard for cylinders ordered w/o hardware (N/A 26/26D)	\$8.55

Mortise Lock Cylinder Rosettes		Price Per Each Piece
Number	Description	03/04/09/10/10B/10BE/10BL/14/15/20D/26/26D/32/32D/BSP/WSP
1KA-1	Cylinder Rosettes – 5/16" Projection	\$67.00
1KA-2	Cylinder Rosettes – 7/16" Projection	\$72.00
1KA-3	Cylinder Rosettes – 9/16" Projection	\$77.00
1KA-4	Cylinder Rosettes – 11/16" Projection	\$84.00
1KB-1	Cylinder Rosettes – 5/16" Projection	\$19.00
1KB-2	Cylinder Rosettes – 7/16" Projection	\$19.00
1KB-3	Cylinder Rosettes – 9/16" Projection	\$19.00
1KB-4	Cylinder Rosettes – 11/16" Projection	\$24.00
1SB-1	Cylinder Rosettes – 5/16" Projection	\$51.00
1SB-2	Cylinder Rosettes – 7/16" Projection	\$54.00
1SB-3	Cylinder Rosettes – 9/16" Projection	\$54.00
1SB-4	Cylinder Rosettes – 11/16" Projection	\$54.00

Cylinder Turn Knobs		Add
Option	Description	
124	Cylinder Turn Knobs	\$38.00
Number		04/10B/10BE/BSP/WSP
41 thru Size 46	Sizes 41-46 standard cam	
41-105 thru Size 46-105	Sizes 41-46 inside cylinder for 78/82 (16 & 92) functions	\$96.00
41-101 thru Size 46-101	Sizes 41-46 for #1850 Adams Rite Lock	

Mail Box Cylinder		Finishes
Number		04/15
4101		\$118.00
01-4169	Cam Screw (2 required per cylinder)	\$0.62
13-0525	4101 Plug	\$32.84
13-0527	Cam	\$3.42
06-0166	Retaining Ring	\$2.24

Note: U.S. Postal regulations DO NOT allow masterkeyed Mail Box Cylinders.
Available Keyed Different ONLY.

USA & Canada Prices Effective May 1, 2021

T-Zone (11-Line) 10L, 6500L, 7L Cylinder Assemblies and Components		
Part#	Description	Price
*C11-1	Cylinder - 11L T-Zone Lever Lock (except 50 function)	\$94.00
*C11-2	Cylinder - 11L T-Zone Lever Lock - 50 function	\$139.00
*C10-1	Cylinder - 10, 8L, 7L, 6500 Lever Lock	\$94.00
*C10-2	Cylinder - 10, 8L, 7L, 6500 Lever Lock - 50 function	\$139.00
13-3257	Body & Slide Assy. (11, 10, 7, 6500)	\$45.16
*13-3142	Cyl. Plug & Ring Assy. (11, 10, 7, 6500)	\$32.84
11-0231	Cyl. tailpiece for VC 11 line	\$1.83
05-0017	Plastic Cyl. Support Ring (6500)	\$0.45
05-0028	Cyl. Retainer Lever (6500)	\$0.83
05-0040	Cyl. Tailpiece-6500 7-Pin XC	\$7.99
10-0019	Plastic Cyl. Support Ring (10L)	\$0.71
10-0239	Cyl. Tailpiece 6-Pin (SFIC & LFIC - 6500, 10L, 7L) Except 54 Function	\$2.05
10-0240	Cyl. Tailpiece 7-Pin (SFIC-10L, 6500, 7L) Except 54 Function	\$2.05
10-0286	Cyl. Tailpiece 6-Pin (54 function 10L, 7L)	\$2.05
10-0287	Cyl. Tailpiece 7-Pin (54 function - 10L, 7L)	\$2.05
10-0842	Tailpiece (10 Line) for Schlage SF option	\$5.27
11-0403	Tailpiece (11 Line) for Schlage SF prefix	\$4.97
10-3138	Cyl. Tailpiece-10L, 7L 7-Pin XC	\$6.58
11-0171	Cyl. Tailpiece 6-Pin (SFIC - 11L)	\$1.83
11-0172	Cyl. Tailpiece 6-Pin (LFIC-11L) & 7-Pin (SFIC-11L)	\$1.83
11-0276	Cyl. Tailpiece-11L 7-Pin XC	\$6.59
*13-0201	Cyl. Plug - 11L 50 function	\$52.00
13-0205	Plug Retaining Ring (11L, 10L, 7L, 6500)	\$2.24
13-0680	Cyl. Tailpiece Retainer (11L, 10L, 7L, 6500)	\$2.24
13-0895	Cyl. Tailpiece (10L, 7L, 6500)	\$2.28
13-1385	Cyl. Tailpiece (11L)	\$2.28

9, 8, 8X Line Cylinder Assemblies and Components		
		Price
* C8-1	Cylinder - 9, 8L Knob Locks (except 50 function)	\$94.00
* C8-2	Cylinder - 9, 8L Knob Locks - 50 function	\$139.00
* C8X-1	Cylinder - 8X Knob Locks - All except 50 function	\$94.00
13-2048	9, 8L Cylinder Body & Slide Assembly.	\$45.16
13-0920	8X Cylinder Plug	\$32.84
* 13-3425	9, 8L Cylinder Plug & Pin	\$32.84
06-0166	9, 8L Plug Retaining Ring	\$2.24
13-0205	Plug Retaining Ring (11L, 10L, 7L, 6500)	\$2.24

6 Line Cylinder Assemblies and Components		
		Price
* C6-1	Cylinder - 6L Knob Lock (S & N knobs)	\$94.00
* C6-1B	Cylinder - 6L Knob Lock (B knob)	\$94.00
* C6-2	Cylinder - 6L Knob Lock (S & N knobs) - 50 function	\$139.00
* C6-2B	Cylinder - 6L Knob Lock (B knob) - 50 function	\$139.00
13-3257	Cylinder body & Slide Assembly	\$45.16
* 13-3142	Cylinder Plug & Ring Assembly	\$32.84
13-0907	Cylinder Tailpiece (S & N Knobs)	\$2.24
13-0908	Cylinder Tailpiece (B Knob)	\$2.24
13-0205	Plug Retaining Ring	\$2.24
* 13-0674	Cylinder Plug/No Ring-50 function	\$32.84
13-0845	Cylinder Tailpiece (S + N Knobs-50 function)	\$2.24
13-0846	Cylinder Tailpiece (D Knob-50 function)	\$2.24
13-0680	Tailpiece Retainer Ring	\$2.24

• **460 series has been discontinued**
***Specify Finish – US4 or US15**

Experience a safer
and more open world

5, 5500 Series Cylinder Assemblies & Components		
		Price
* C5500-1	Cylinder - 5L, 5500 Knob Lock	\$87.00
13-3514	Cylinder Body/Slide	\$45.16
* 13-0920	Cylinder Plug	\$32.84
13-0919	Cylinder Tailpiece	\$2.24
01-0870	Plug Retaining Ring (5500)	\$2.24
05-0214	Retainer (5-Line only)	\$5.79

• 460/470/480 Deadbolt Cylinder		
		Price
* C480-1	Cylinder - 484, 474 Aux Lock	\$94.00
* C480-2	Cylinder - 485, 487 Aux Lock	\$94.00
* C480-3	Cylinder - 475, 486 Aux Lock	\$94.00
* C460-1	Cylinder - 464 Aux Lock	\$94.00
* C460-2	Cylinder - 465 Aux Lock	\$94.00
13-3493	Cylinder Body/Slide Assembly	\$45.16
* 13-0874	Cylinder Plug (470, 480)	\$32.84
* 13-0904	Cylinder Plug (* 460)	\$32.84
* 13-0178	Cylinder Plug (4142, 4143)	\$32.84
13-0875	Cylinder Cap (470, 480)	\$3.42
13-0903	Cylinder Cap (460)	\$3.42
13-0884	Blocking Piece	\$1.14
13-0691	Cylinder Cap Pin for (460, 470, 480) made before 6/03	\$1.14
13-0693	Cylinder Cap Spring (460, 470, 480) made before 6/03	\$1.14
13-0878	Tailpiece (464, 474, 484 -1-3/4" Dr. only)	\$2.15
13-0880	Tailpiece (465, 485, 487)	\$2.15
13-0881	Tailpiece (486, 475)	\$2.89
13-0882	Cylinder Tail Washer (484)	\$2.24
13-0883	Cylinder Tail Washer (465, 475, 485, 486, 487)	\$2.24
13-1554	Cap Pin (460, 470, 480) made after 6/03	\$1.18
13-1555	Cap Spring (460, 470, 480) made after 6/03	\$1.18

7600 Integrallock Cylinders (All functions except 26, 27 & 50)		
Option Number	Description	Price
* C7600-1	Regular	\$141.00
10	* C7600-1 Signature	\$204.00
10-21	* C7600-1 Construction & Signature	\$236.00
21	* C7600-1 Construction	\$173.00
	13-0080 Barrel Retainer	\$1.71
	13-1116 Adaptor for 7600	\$39.01
	13-1139 Cylinder Body 6-Pin	\$47.22
	13-1140 Cylinder Body-Signature	\$47.22

758/858 Padlock		
		Price
C750-1	758/858 Cylinder & Tailpiece Assembly	\$94.00
13-1230	758 Cylinder Tailpiece	\$2.07
13-1231	Tailpiece (60-) for 758/858	\$4.27
17-2633	758/ 858 Cylinder retainer and screw pack	\$15.65
13-4065	63-758/858 Cylinder & Tailpiece Assembly	\$101.44
01-9219	858 Cyl. retainer screw	\$5.82

CK-8 CYLINDERS & KEYING

SARGENT®

XC SERIES

ASSA ABLOY

USA & Canada Prices Effective May 1, 2021

XC Cylinders and Key System - OPTION (to be added to all applicable products, except where noted in product catalogs)

Option	Description	Add
11	XC Key System - Includes 2 change keys standard	No addition

Notes: When expanding existing key systems, a copy of the existing bitting list is required at time of order, if not already on file w/SARGENT Key records department.

XC options not available with the following options: 10, 22, 35, 51, 52, SC, SE

XC options not available with the following lock functions: 50

Available in Small Format Interchangeable core - refer to CK-13 for prices

Orders for new masterkeyed systems will receive 6 master keys. For additional, please note on order.

Keyways available:

SARGENT keyway families: L, R

Prior authorization from SARGENT key records is required before establishing a new key system

Keying Charges & Substitutions Add

Masterkeying or Higher level of keying, any quantity	
Masterkeying or Higher level of keying, any quantity, cylinder only	\$16.00 /cyl
Construction Masterkeying (21-) with cylinders only	
Construction Masterkeying (21-) with lockset or exit device or cylinder	

Cut Master/Change (Day) Keys

Option	Number	Description	Price Each
11	X6272MK	Masterkey, Grandmasterkey – 6 pin	
11	X6272CMK	Construction Masterkey – 6 pin	\$9.00
11	X6272CHK	Change (Day) Key – 6 pin	

Keyblanks - Packed 50 per Box Keyway Families Available

Option	Number	Description	Price Each
11	X6270	Master Keyblanks 6-Pin L, R	
11	X6275	Day/Change Keyblanks 6-Pin L, R	refer to CK-15

Note: All SARGENT XC keyblanks are identified with the following markings: SARGENT, "XC", "PAT. 6,526,791 and DO NOT DUPLICATE"

Extra Keys - Cylinders are packed standard with 2 change keys each Price

For each extra key ordered with locksets, exit devices or cylinders	\$5.00 /key
For keys packed separately	\$4.00 /cylinder

Additional Charges:

Key Marking - Special marking is limited to space on blank side of keyblank

Visual Key Control -

Delete SARGENT logo

Restricted Keyway - for charges

All orders for restricted keyblanks, barrels, or product containing cylinders that have a restricted keyway must include a letter of authorization or a copy of purchase order from the end user.

Prior authorization from SARGENT key systems is required before establishing a new key system that requires a restricted keyway.

Refer to CK-3

USA & Canada Prices Effective May 1, 2021

Note: Mortise & Rim cylinder housings include #97 Rossette are available in the following finishes: 3, 4, 9, 10, 10B, 10BE, 10BL, 14, 15, 20D, 32, 32D, BSP, WSP. Bored Cylinder Assemblies, cylinder plugs/barrels are available in the following finishes: 4, 15.

Mortise Cylinder 6 Pin (The XC add is included)		
Number	Specify finish when ordering	Price
11-41, 11-42, 11-43, 11-44, 11-46		\$96.00
11-48, 11-50, 11-52, 11-54		\$141.00
11-56		\$345.00
Note: Price does not include Masterkeying		

Body & Slide - 6-Pin - Mortise Cylinder (11-40 Series)		
Number	Specify finish when ordering	Price
13-4301	for #41	\$48.78
13-4302	for #42	
13-4303	for #43	
13-4304	for #44	
13-4305	for #46	
13-4306	for #48	\$70.31
13-4307	for #50	
13-4308	for #52	
13-4309	for #54	
13-4310	for #56	

Plug - 6-Pin - Mortise Cylinder (11-40 Series)		
Number	Specify finish (4 or 15)	Price
13-4314	for #41	\$32.84
13-4315	for #42	
13-4316	for #43	
13-4317	for #44	
13-4318	for #46	
13-4319	for #48	\$49.28
13-4320	for #50	
13-4321	for #52	
13-4322	for #54	
13-4323	for #56	

Optional Cams for use w/11-40 Series Mortise Cylinders		
Cam No.		Add/cyl
101	For Adams Rite 1850, 4700	No Addition
105	SARGENT Short Cams I/S 78/82 (16 & 92) functions	
106*	For Schlage "L"	
112	"Open" Misc. - Wide Straight Cam	
113*	For 4370 Key Switch Coverleaf Cam	
01-1121	Cam Screw (Price/Pack - 100 cams)	\$31.40

Rim Cylinder (The XC add is included)		
Number	Specify finish when ordering	Price
11-34		\$96.00
Note: Price does not include Masterkeying		

Body & Slide - 6-Pin - Rim Cylinder (11-34 series)		
Number	Specify finish when ordering	Price
13-4301		\$48.78

Plug - 6-Pin - Rim Cylinder (11-34 series)		
Number	Specify finish (4 or 15)	Price
13-4312		\$32.84

Bored Cylinder Assembly 6 Pin (The XC add is included)		
Option/Number	Specify finish (4 or 15)	Price
11 C11-1	for T-Zone	\$94.00
11 C10-1	for 10, 7L, 6500 (8 Line lever)	
11 C8-1	for 8, 9 (7 Line knob)	
11 C8X-1	Cylinder - 8X Knob Locks All Except 50 Function	
11 C6-1	for 6 Line (S & N knobs)	
11 C6-1B	for 6 Line (B knob)	
11 C5500-1	for 5500	
11 C480-1	for 474, 484	
11 C480-2	for 485, 487	
11 C480-3	for 475, 486	
11 C460-1	for 464	
11 C460-2	for 465	
11 C750-1	for 758 Padlock	\$141.00
11 C7600-1	for 7600 Integra (Except 26, 27, & 50)	

Note: Price does not include Masterkeying

Note: Above available for all functions except 50 function

Cylinder Body - Bored Lock			
Number		Price	
13-4334	for T-Zone, 10, 7L, 6500 (8 Line lever)	\$45.16	
13-4335	for 8, 9 (7 Line knob)		
13-4336	for 6 Line (B, S & N knobs)		
13-4338	for 5500		
13-4337	for 460, 470, 480 Series		
13-4334	for 758 Padlock		
13-4339	for 7600 Integra Lock		
13-4339	for 7600 Integra Lock		\$47.22

Barrel/Plug Assembly - Bored Lock			
Number	Specify finish (4 or 15)	Price	
13-4332	for T-Zone, 10, 7L, 6500 (8 Line lever)	\$32.84	
13-4332	for 6 Line (B, S & N knobs)		
13-4331	for 8, 9 (7 Line knob)		
13-4328	for 5500		
13-4330	for 480, 470 Series		
13-4329	for 460 Series		
13-4332	for 758 Padlock		
13-4312	for 7600 Integra Lock		\$32.84

CK-10 CYLINDERS AND KEYING

SARGENT®

ASSA ABLOY

LARGE FORMAT IC CORE CYLINDERS & OLD STYLE REMOVABLE CORE CYLINDERS

USA & Canada Prices Effective May 1, 2021

Note: Mortise & Rim cylinder housings include #97 Rossette are available in US3, 4, 9, 10, 10B, 10BE, 10BL, 14, 15, 20D, 32, 32D, BSP, WSP finishes. Bored cylinder plugs/barrels/cores will be in either US4 or 15. Specify finish when ordering.

SARGENT Large Format Interchangeable Core Mortise & Rim Cylinders - Includes Master & Grand Master Keying Charges		Price
Number		Specify Finish
6334 (rim), 6342, 6343, 6344, 6346	6-Pin only	\$179.00
50-6343	6-Pin only - Hotel cylinder	\$210.00
SARGENT Large Format Interchangeable Cores ONLY - Includes Master & Grand Master Keying Charges		
6300	6-Pin	\$83.00
SARGENT Large Format Interchangeable Core Housings - Mortise (includes standard Cam unless specified other) & Rim Bodies ONLY		
6034 (Rim), *6042, *6043, *6044, *6046	6-Pin only	\$96.00
50-6043	6-Pin only - Hotel Cylinder	\$127.00
Cut Master/Change (Day) Keys		
6272CTL	Control Key	
6272MK	Master Key	\$9.00
6272CHK	Change (Day) Key	
*Cylinders with following Cams (6042, 6342, 6043, 6343, 6044, 6344, 6046, 6346 Cylinders)		
101	For Adams Rite – 1850, 4700	
105	Sargent Short Cam – for 16 & 92 functions	
106	For Schlage L	No Addition
112	"Open" Misc. – Wide Straight Cam	
113	For 4370 Key Switch	
115	SARGENT Removable (63-) Hotel (50-) Cam for 50-60/63-43 cyl.	
Note: *Cams must be ordered with cylinders – permanently attached at the factory.		
SARGENT Large Format Interchangeable Cores ONLY - Unassembled		
65-6300**	H-Keyway – standard – other Keyways available	\$73.00
65-50-6300**	Hotel Cores - C family Keyway-standard	
Disposable Plastic Core (60-Option)		
13-5177	Plug Assembly (RC-60)	\$4.68
6300 Plug/Parts		
13-0795	6-Pin – Barrel	\$32.84
13-3424	Inner Body and Slide Assy for 6300	\$32.84
13-0796	Control Sleeve for 6300	\$28.52
01-0660 (Price/Pack - 100 rings)	Retaining Ring for 6300 & 10-6300 & 11-6300	\$96.97
13-0797 (Price/Pack - 100 slides)	Slide for 6300 made before 3/06 w/box logo	\$43.70
13-1341 (Price/Pack - 100 slides)	Slide for 6300 made after 4/06 w/o box logo	\$43.70
Removable Core Cylinders - OLD STYLE - FOR EXISTING SYSTEMS ONLY - Prices DO NOT include keying charges.		Specify Finish
51 Option	Permanent Core	Add \$85.00 Each Cylinder
52 Option	Construction Core	See CK-2
Removable Core Cylinders - OLD STYLE - FOR EXISTING SYSTEMS ONLY - Prices DO NOT include keying charges		Specify Finish
134	Rim	7-Pin
142, 143, 144, 146	Mortise	7-Pin
		\$95.00
Note: Must specify 51- (permanent core) or 52- (construction core) option when ordering old style removable core cylinders		
Removable Core ONLY - OLD STYLE - FOR EXISTING SYSTEMS ONLY - Prices DO NOT include keying charges.		Specify Finish
5134	(for Rim)	7-Pin
5142, 5143, 5144, 5146	(for Mortise)	7-Pin
		\$85.00
Plug ONLY - OLD STYLE		Specify Finish
13-0402	Mortise Plug	7-Pin
13-0242	Rim Plug	7-Pin
		\$41.68
Mortise and Rim Housing Only - OLD STYLE		Specify Finish
13-2052	Mortise	7-Pin
13-2053	1-3/8" long mortise body only	
13-2054	1-1/2" long mortise body only	
13-2055	1-3/4" long mortise body only	
13-2057	Rim 5&6-Pin back plate and screws to be ordered separately	
		\$81.44
13-0265 (Price/Pack - 100 springs)	Spring for all chambers except control	\$16.39
13-0215 (Price/Pack - 100 springs)	Spring only for control chamber	\$96.97
13-1797 (Price/Pack - 100 springs)	7-pin Slide without box logo	\$86.03

**Specify finish – US4 or US15

Experience a safer
and more open world

Copyright © 2002-2021 Sargent Manufacturing Company, an ASSA ABLOY Group company. All rights reserved.
Reproduction in whole or in part without the express written permission of Sargent Manufacturing Company is prohibited.
Contact us at: 800-727-5477 or visit www.sargentlock.com. In Canada contact us at: 800-461-3007 or visit www.assaabloydss.ca

SARGENT XC LARGE FORMAT INTERCHANGEABLE CORE CYLINDERS

USA & Canada Prices Effective May 1, 2021

Note: Mortise & Rim cylinders include #97 Rossette are available in US3, 4, 9, 10, 10B, 10BE, 10BL, 14, 15, 20D, 32, 32D, BSP, WSP finishes. Cylinder plugs/barrels/cores will be in either US4 or 15. Specify finish when ordering.

SARGENT XC Large Format Interchangeable Core Options:		
Options	Description	Add
1160	SARGENT XC Large Format Interchangeable Core - plastic disposable core provided	No Addition
1163	SARGENT XC Large Format Interchangeable Core - 6 pin keyed	\$83.00
1164	SARGENT XC Large Format Interchangeable Core, 6-Pin construction core provided	\$83.00

Note: 11-6300 core will only work in Sargent hardware ordered with 11-60, 11-63, or 11-64 options.

Option	No.	Cut Master/Change (Day) Keys	
11	X6272CTL	Control key	
11	X6255CTL	Control key for 1 bitted 11-6300 cores	
11	X6272MK	Masterkey	\$9.00
11	X6272CHK	Change (Day) Key - 6 Pin	

Retrofit Parts/Tail Pieces required with hardware not ordered to accept 11-6300 core		Price
08-5265	10-60-63 8 Line Knob Parts Pack	\$43.20
10-3429	10, 7, 6500 Tail Piece & Retainer Pack	\$9.95
11-5003	11 Line "T-Zone" Tail Piece & Retainer Pack	\$9.10
13-5178	11-60-63-34 Rim Cylinder Parts Pack	\$38.78
16-2508	460 Series Cam Assembly	\$4.04
17-2632	758/858 Tail Piece & Retainer Pack	\$11.37
431-6	Shear Tool used to modify existing 60- Mortise cylinder housings to accept 11-6300 core	\$452.00
432RC	Mortise Removable Core Cylinder Installation Tool	\$77.00

XC Large Format Interchangeable Core Mortise & Rim Cylinders – Includes Master & Grand Master Keying Charges Price		Price Specify Finish
11-6334 (Rim), 11-6342	6-Pin Only	
11-6343, 11-6344	6-Pin Only	\$179.00
11-6346	6-Pin Only	

XC Large Format Interchangeable Core ONLY - Includes Master & Grand Master Keying Charges		
11-6300	6-Pin	\$83.00

XC Large Format Interchangeable Core Cylinders - Mortise (includes standard Cam unless specified other) & Rim Bodies ONLY		
11-6034 (Rim), *11-6042	6-Pin Only	
*11-6043, 11-6044	6-Pin Only	\$96.00
11-6046	6-Pin Only	

*Cylinders with following optional Suffix Cams (11-6042, 11-6342, 11-6043, 11-6343, 11-6044, 11-6344, 11-6046, 11-6346 Cylinders)		
101	For Adams Rite – 1850, 4700	
105	Sargent Short Cam – for 78/8200 16 & 92 functions	
106	For Schlage L	No Addition
112	"Open" Misc. – Wide Straight Cam	
113	For 4370 Key Switch	

Removable Cores ONLY - Unassembled		
11-65-6300**		\$73.00

Disposable Plastic Core (11-60 Option)		
13-5177	Plug assembly	\$4.68

11-6300 Plug/Parts		
13-4326	6-Pin Barrel XC	\$32.84
13-5175	Inner Body and Slide Assy for 11-6300	\$32.84
13-0796	Control Sleeve for 6300 & 11-6300	\$28.52
01-0660 (Price/Pack - 100 rings)	Retaining Ring for 6300, 10-6300, & 11-6300	\$96.97
13-1341 (Price/Pack - 100 slides)	6-pin Slide for 6300 made after 4/06 without box logo	\$43.70

Note: Cylinders shipped less hardware comes with #97 cylinder ring.

CK-12 CYLINDERS AND KEYING

SARGENT®

SMALL FORMAT INTERCHANGEABLE CORE

ASSA ABLOY

USA & Canada Prices Effective May 1, 2021

SMALL FORMAT INTERCHANGEABLE CORE OPTION (to be added to all applicable products, except where noted in product catalogs)		
Options	Description	Add
70	Small Format Interchangeable core - plastic disposable core provided	No addition
72	Small Format Interchangeable core - 6-Pin construction core provided	\$75.00
73	Small Format Interchangeable core - 6-Pin keyed - Includes Master & Grand Master Keying charges	\$75.00 /cyl
73-7P	Small Format Interchangeable core - 7-Pin keyed - Includes Master & Grand Master Keying charges	

Notes: Orders with Small Format Interchangeable type construction cores (72-) receive 6 construction keys and 1 control key per order as standard. For additional, please note on order.
Orders for new masterkeyed systems will receive 6 master keys. For additional, please note on order.
Mortise cylinder offered size #43 or 46 with SARGENT offset cam only;
Rim cylinders size #34 only with SARGENT hole pattern.
When expanding existing key systems, a copy of the existing bitting list is required at time of order, if not already on file w/SARGENT Key records department.

Keyways available:

Small format competitor keyway: A, B, C, D, E, F, G, H, J, K, L, M.
Small format SARGENT keyway: 4A standard, 4B restricted keyway - A2 or A4 System.

Prior authorization from SARGENT key records is required before establishing a new key system.

Cut Master Keys and Change Keys		Price Each
6282BMK	Masterkey/Grandmasterkey – 6 pin	\$9.00
7282BMK	Masterkey/Grandmasterkey – 7 pin	
6254BCTL	Construction Control Key (72-) 6 pin	
6282BCMK	Construction Masterkey (72-) 6 pin	
6282BCTL	Control Key (73-) 6 pin permanent core	
7282BCTL	Control Key (73-) 7 Pin permanent core	
6282BCHK	Day/change key (73-) - 6 pin	
7282BCHK	Day/Change key (73-7P) - 7 pin	

Keyblanks - Packed 50 per Box		Price
6285B	Small Format system Keyblanks - 6 Pin - specify keway required - example: 6285BA	\$2.93
7285B	Small Format system 7 pin Keyblanks specify keway required - example: 7285B-4A	\$6.12
6285B4B	Small Format system Keyblanks - 6 Pin Restricted Keyway - example: 6285B4B	
7285B4B	Small Format system 7 pin Keyblanks - Restricted Keyway - example: 7285B 4B	

Visual Key Control		Price
Stamping of cylinder plug not available, stamping of the keys with key set standard		N/A
Each additional key stamped		\$1.00 /key
Concealed Stamping of Keyset on core (7 Characters)		\$8.00 /cyl
Cylinder permanent stamping options: Cylinder plug/barrel face		N/A

Additional Charges:

Extra Keys -	Refer to CK-3
Key Marking - Special marking is limited to space on blank side of keyblank	Refer to CK-3
Delete SARGENT Logo/Key Section	N/A
Restricted Keyway - for charges	Refer to CK-3
Less Logo/Key Section	N/A

Mortise/Rim Cylinder with IC Core, Cylinder Shells			IC Cores ONLY – Keyed, Uncombined, Construction Cores		
Number	Description	Price	Number	Description	Price
73-43	1-3/8" Mortise 6-Pin w/SARGENT cam	\$171.00	7300B	6-Pin Master keyed core	\$75.00
73-46	1-3/4" Mortise 6 Pin w/SARGENT cam		7P-7300B	7-Pin Master keyed core	
73-34	Rim 6-Pin		65-7300B	6-Pin uncombined - no keyblanks	\$65.00
73-7P-43	1-3/8" Mortise 7-Pin w/SARGENT cam		65-7P-7300B	7-Pin uncombined - no keyblanks	
73-7P-46	1-3/4" Mortise 7-Pin w/SARGENT cam	\$96.00	7200	6 Pin Construction core (72-)	\$75.00
73-7P-34	Rim 7-Pin		13-5176	Disposable plastic core - assy	\$2.26
70-43	1-3/8" Mortise 6 or 7 Pin cylinder shell		13-1507	70-34 rim cylinder tail piece	\$2.23
70-46	1-3/4" Mortise 6 or 7 Pin cylinder shell				
70-34	Rim 6 or 7 Pin cylinder shell				

Note: Specify finish: 3, 4, 9, 10, 10B, 10BE, 10BL, 14, 15, 20, 26, 26D, BSP, WSP.

Experience a safer
and more open world

Copyright © 2002-2021 Sargent Manufacturing Company, an ASSA ABLOY Group company. All rights reserved.
Reproduction in whole or in part without the express written permission of Sargent Manufacturing Company is prohibited.
Contact us at: 800-727-5477 or visit www.sargentlock.com. In Canada contact us at: 800-461-3007 or visit www.assaabloydss.ca

XC SMALL FORMAT INTERCHANGEABLE CORE OPTIONS

(to be added to all applicable products, except where noted in product catalogs)

Options	Description	Add
1170	XC Small Format Interchangeable core - plastic disposable core provided	No addition
11727P	XC Small Format Interchangeable core - 7-Pin construction core provided	\$75.00
11737P	XC Small Format Interchangeable core - 7-Pin keyed - Includes Master & Grand Master Keying charges	\$75.00 /cyl

Notes: For use in Sargent hardware only and only for use in hardware ordered with proper prefixes such as 11-70, 11-72-11-73. Orders with XC Small Format Interchangeable type construction cores (11-72-) receive 6 construction keys and 1 control key per order as standard. For additional, please note on order. Orders for new masterkeyed systems will receive 6 master keys. For additional, please note on order. Mortise cylinder size #43 with SARGENT offset cam only; Rim cylinder size #34 only with SARGENT hole pattern. When expanding existing key systems, a copy of the existing bitting list is required at time of order, if not already on file w/SARGENT Key records department.

Keyways available:

XC Small format SARGENT keyway families: 4A standard, **4B restricted keyway** - A2 or A4 System

Prior authorization from SARGENT key records is required before establishing a new key system

Option	Number	Cut Master Keys cut day/change keys	Price Each
11	X7282BMK	XC Masterkey/Grandmasterkey	
11	X7282BCTL	Control Key - 7 pin	
11	X7282BCHK	XC day/change key - 7 pin	
	7282BCMK	XC Construction Masterkey 11-72	
	7254BCTL	XC Construction Control Key 11-72	\$9.00

Option	Number	Keyblanks - Packed 50 per Box	Price
11	X7285B	XC Small Format system Keyblanks - 7 Pin - example: 11-X7285B4A	\$2.93
11	X7285B4B	XC Small Format system Keyblanks - Restricted Keyway - example: 11-X7285B4B	\$6.12

Prior authorization from SARGENT key records is required before establishing a new key system

Notes: All SARGENT XC keyblanks are identified with the following markings:
SARGENT, "XC", PAT, 6,526,791 and DO NOT DUPLICATE

Extra Keys - Cylinders are packed standard with 2 keys each	Price
For each extra key ordered with locksets, exit devices or cylinders	\$5.00 /key
For cylinders packed separately	\$4.00 /cyl

Visual Key Control	Price
Stamping of cylinder plug and/or two keys with industry standard alpha numeric keyset symbol (Plug N/A stamped)	N/A
Each additional key stamped	\$1.00 /key
Stamping code (keyset symbol) on mortise cylinder, rim cylinder, or 11-7300B body	\$8.00 /cyl
XC Cylinder permanent stamping options: Cylinder plug/barrel face	N/A
XC 11-7300B cores stamped on the side of core with up to 7 characters	\$8.00 /cyl

Additional Charges:

Key Marking - Special marking is limited to space on blank side of keyblank	Refer to CK-3
Delete SARGENT Logo/Key Section	N/A
Restricted Keyway - for charges	Refer to CK-3
Less Logo/Key Section	N/A

Mortise/Rim Cylinder with IC Core, Cylinder Shells			IC Cores ONLY – Keyed, Uncombined, Construction Cores		
Number	Description	Price	Number	Description	Price
11737P-34	XC Rim Cyl. 7-Pin		117P-7300B	7-Pin Master keyed core	\$75.00
11737P-43	XC Mortise 7-Pin w/SARGENT cam	\$171.00	11657P-7300B	7-Pin uncombined - no keyblanks	\$65.00
11737P-46	XC Mortise Cyl. 7-Pin		117P-7200	Construction core (11-72-)	\$75.00
1170-34	XC Rim 7 Pin cylinder shell		13-5174	Disp. plastic core - bottom plug (70-)	\$4.04
1170-43	XC Mortise 7 Pin cylinder shell	\$96.00	431-7	Pin Shear Tool	\$452.00
1170-46	XC Mortise 7 Pin cylinder shell		05-0040	XC Tailpiece - 6500-7-Pin	\$7.99
			10-3138	XC Tailpiece - 10L-7-Pin	\$6.58
			11-0276	XC Tailpiece - 11L-7-Pin	\$6.59
			13-1507	11-70-34 rim cylinder tail piece	\$2.23

Note: Specify finish: 3, 4, 9, 10, 10B, 10BE, 10BL, 14, 15, 20, 26, 26D, BSP, WSP

CK-14 CYLINDERS & KEYING

SARGENT®

KEYING KITS • TOOLS • GAUGES • COMPONENTS

ASSA ABLOY

USA & Canada Prices Effective May 1, 2021

Keying Kits • Tools • Gauges		Price
—	Depth Key Sets	\$59.00
LT2	Cylinder Loading Thimble	\$67.00
LT6	Cylinder Loading Rod	\$59.00
2	Tru-Arc Plier	\$59.00
431-6	Shear Tool used to modify existing 60- Mortise cylinder housings to accept 11-6300 core	\$452.00
431-7	Small Format Pin Shear Tool	\$452.00
432RC	Sargent Removable Core Installation Tool	\$77.00
432IC	Small Format Interchangeable Core Installation Tool	\$77.00
436-1	Top Loading Kit	\$725.00
435	Key Gauge	\$41.00
437BR	Bump Resistant Retrofit pinning Kit	\$456.00
437C	Rekeying Kit (Conventional Keying)	\$924.00
437RC	Removable Core Rekeying Kit (Conventional & Signature)	\$434.00
437S	Signature Re-keying Kit	\$924.00
439	Lost Ball (21 Option) Field Construction Keying Kit	\$622.00
13-1034	Loading Rod (6, 8, 10L & Mortise)	\$29.45
13-1035	Loading rod (480, 6300)	\$43.42
13-1037	Pin Loading Rod	\$15.41
13-1103	Field Construction Balls (3 required per cylinder) (Price/Pack - 500/pack)	\$150.23
13-1138	Spring Loading Rod	\$15.41
14-0070	Extractor (Used with 22- Option)	\$5.58
18-0070	Cylinder Lube Spray	\$29.45
18-0435	Cylinder Cleaner/De-Icer	\$29.45
77-0273	Loading Rod	\$23.59

Part No. Bottom (Key) Pin	Size	Price/Pack = 100 Pins
13-0064	1	\$19.00
13-0065	2	
13-0066	3	
13-0067	4	
13-0068	5	
13-0069	6	
13-0070	7	
13-0071	8	
13-0072	9	
13-0073	10	

Cylinder Spring/Slides (100/pack)		Price/Pack
13-0265	Springs	\$16.39
13-0779	KIK/KIL slides for cyls. made prior to June, 2008	\$43.70
13-0797	Slide for 6300 made before 3/06 with box logo	\$43.70
13-0487	Hollow Driver Spring (3rd & 4th)	\$96.97
13-0215	Control Spring for Old Style Rem. Core	\$96.97
13-1341	KIK/KIL slides for cyls. made after June, 2008	\$43.70
13-1769	Springs for all chambers in factory master keyed 6300s starting 1/1/09	\$21.84

Signature Cylinder Pins (Optional for 437RC kit) Hardened Stainless Pins (for UL437 Cylinders)		
Part. No.	Size	Price/Pack = 25 Pins
13-1210	1	\$97.00
13-1211	2	
13-1212	3	
13-1213	4	
13-1214	5	
13-1215	6	
13-1216	7	
13-1217	8	
13-1218	9	
13-1222	B-Driver	
13-1223	C-Driver	

Note: To re-key existing Sargent UL437 Cylinders.

Master Pins (Splits & Drivers)		Price/Pack = 100 Pins
Part No.	Size	
13-0051	2	\$19.00
13-0052	3	
13-0053	4	
13-0054	5	
13-0055	6	
13-0056	7	
13-0057	8	
13-0058	9	
13-0059	10	
13-0060	11	
13-0061	12	
13-0062	13	
13-0063	14	

For Sargent 6300 LFIC & Signature Removable Core—for 3rd & 4th positions: Price/Pack =		
Part. No. Hollow Drivers	Size	100 Pins
13-1229	3	\$50.00
13-1234	4	\$28.00
13-1235	5	
13-1236	6	
13-1237	7	
13-1238	8	
13-1239	9	
13-1240	10	
13-1761	11	

For Sargent 6300 LFIC & Signature Removable Core—Parts:		Price/Pack = 100 Rings
Part. No. Miscellaneous		
01-0660	Retaining Ring	\$96.97

Bump Resistant Pins (Min. Qty. 100 ea.)		Price/Pk= 100 Pins
Part No.	Size	
13-1770	10	\$63.00
13-1773	13	

Experience a safer
and more open world

Copyright © 2002-2021 Sargent Manufacturing Company, an ASSA ABLOY Group company. All rights reserved. Reproduction in whole or in part without the express written permission of Sargent Manufacturing Company is prohibited. Contact us at: 800-727-5477 or visit www.sargentlock.com. In Canada contact us at: 800-461-3007 or visit www.assaabloydss.ca

Key Blanks - 5 Pin (Minimum Quantity – 50 each)		Price
Number	Section	Per Each Key
<i>Single Keyway Systems</i>		
265	U*, R*	\$3.10
275	S*	\$2.50
*Used on existing systems ONLY.		
<i>Multi Keyway Systems – Composite Sections</i>		
270	LD, LH, LM, RD, RH, RM	\$2.80
270	LDH, LDM, LHM, LN, RDH, RDM, RHM, RN	\$2.80
273	CD, CH, CM (Large Bow)	\$4.70
273	CDH, CDM, CHM, CN (Large Bow)	\$4.70
<i>Multi Keyway Systems – Single Sections</i>		
275	LA, LB, LC, LE, LF, LG, LJ, LK, LL, RA, RB, RC, RE, RF, RG, RJ, RK, RL	\$2.50
Single Keyway System (Large bow)		
278	CR	\$3.80
Multi Keyway System (Large bow)		
278	CA, CB, CC, CE, CF, CG, CJ, CK, CL	\$3.80
Key Blanks - 6 PIN (Minimum Quantity – 50 each)		
<i>Single Keyway Systems</i>		
6265	U*, R*	\$3.10
6275	S*	\$2.70
*Used on existing systems ONLY.		
<i>Multi Keyway Systems – Composite Sections</i>		
6270	HD, HH, HM, LD, LH, LM, RD, RH, RM	\$2.90
6270	HDH, HDM, HHM, HN, LDH, LDM, LHM, LN, RDH, RDM, RHM, RN	\$2.90
<i>Multi Keyway Systems – Composite Sections (Large Bow)</i>		
6273	CD, CH, CM	\$4.70
6273	CDH, CDM, CHM, CN	\$4.70
<i>Multi Keyway Systems – Single Sections</i>		
6275	HA, HB, HC, HE, HF, HG, HJ, HK, HL, LA, LB, LC, LE, LF, LG, LJ, LK, LL, RA, RB, RC, RE, RF, RG, RJ, RK, RL	\$2.50
<i>Multi Keyway Systems – Large Bow Single Sections</i>		
6278	CA, CB, CC, CE, CF, CG, CJ, CK, CL	\$3.80
<i>Single Keyway System - Large Bow</i>		
6278	CR	\$3.80
<i>Option Number</i>	<i>XC Keyblanks available in L, R Keyway Families</i>	
11 X6270	L, R Master Keyblanks 6-Pin	\$3.00
11 X6270	LD, LH, LM, RD, RH, RM	\$2.90
11 X6270	LDH, LDM, LHM, LN, RDH, RDM, RHM, RN	\$3.00
11 X6275	L, R Day/Change Keyblanks 6-Pin	\$2.50
For keys not shown, consult factory.		
<i>SFIC Families</i>		
6285B	6 pin -x Keyway – A, B, C, D, E, F, G, H, J, K, L, M, 4A	\$2.93
7285B	7 pin -x keyway – A, B, C, D, E, F, G, H, J, K, L, M, 4A	\$2.93
<i>XC SFIC Families</i>		
11 X7285B	Keyway – 4A 7 pin blanks	\$2.93

CK-16 CYLINDER & KEYING

SARGENT®

KEYBLANKS

ASSA ABLOY

USA & Canada Prices Effective May 1, 2021

Key Blanks - 7 Pin (Minimum Quantity – 50 each)		Price
Number	Section	Per Each Key
<i>Single Keyway Systems</i>		
7275	S*	\$2.70
*Used on existing systems ONLY.		
<i>Multi Keyway Systems – Composite Sections</i>		
7270	LD, LH, LM, RD, RH, RM	\$3.00
7270	LDH, LDM, LHM, LN, RDH, RDM, RHM, RN	\$3.00
<i>Multi Keyway Systems, Composite Sections (Large Bow)</i>		
7273	CD, CH, CM	\$4.70
7273	CDH, CDM, CHM, CN	\$4.70
<i>Multi Keyway Systems – Single Sections</i>		
7275	LA, LB, LC, LE, LF, LG, LJ, LK, LL, RA, RB, RC, RE, RF, RG, RJ, RK, RL	\$2.70
<i>Multi Keyway Systems – Large Bow Keys</i>		
7278	CA, CB, CC, CE, CF, CG, CJ, CK, CL	\$3.80
Restricted Keyblanks - End user authorization letter required with each order. SARGENT Keyway family's – A, B, G, K, N, V		
6275	Non-Published (restricted) Day Key Blank (6 pin)	\$3.40
6270	Non-Published (restricted) Master Key Blank (6 pin)	\$3.80
7275	Non-Published (restricted) Day Key Blank (7 pin)	\$3.50
7270	Non-Published (restricted) Master Key Blank (7 pin)	\$3.80
<i>Option Number</i>	<i>XC SFIC</i>	
11	X7285B 4B Keyway - small format 7 Pin	\$6.12
	6285B 4B - small format 6 pin	\$6.12
	7285B 4B - small format 7 pin	\$6.12

Note: For anything not listed, consult factory
Consult Factory for Large Bow Keys.

Cut Master Level/Change (Day) Keys		
Number	Description (provide key system registration # when ordering)	Price Each
272MK	Master Keys – 5 Pin	
6272MK	Master Keys – 6 Pin	
7272MK	Master Keys – 7 Pin	
6250CMK	Construction Master Key (22-) 6 pin	
272CMK	Construction Master Keys - 5 Pin (21-)	
6272CMK	Construction Master Key – 6 Pin (21-)	
7272CMK	Construction Master Keys - 7 Pin (21-)	
6267EMK	Emergency Key, Bored Locks – 6 Pin Key, 6 Pin System	
7268EMK	Emergency Key, Mortise Locks – 7 Pin Key, 6 Pin System	
7269EMK	Emergency Key, Removable Core, Hotel Function – 7 Pin Key, 6 Pin System	
6272CTL	6 Pin Control Key for 6300s	
6255CTL	Control Key – 1 Bitted for 6300's (63-)	\$9.00 Each
6253CTL	Control Key (51-)	
7253CTL	Control Key – 7 Pin Key – 6 Pin System (51-)	
272CHK	Change (Day) Key - 5 Pin	
6272CHK	Change (Day) Key - 6 Pin	
7272CHK	Change (Day) Key - 7 Pin	
6251CMK	Temporary Construction Removable Core Master Key - 6 pin used with 64-11-64- and DG-64-	
6251CTL	Temporary Construction Removable Core Control Key - 6 pin used with 64-11-64 and DG-64-	
6282BCMK	Construction Interchangeable Core Master Key - 6 pin used with 72-	
6254BCTL	Construction Interchangeable Core Control Key - 6 pin used with 72-	
7282BCMK	Construction Interchangeable Core Master Key - 7 pin used with 11-72-	
7254BCTL	Construction Interchangeable Core Control Key - 7 pin used with 11-72-	

Note: On new master keyed systems, use keying cover sheets, removable and interchangeable core systems, and construction Master keyed system orders, please specify quantity of master keys, control keys, and master construction keys required. If order does not give quantities of key requirements, a minimum of 6 each master keys will be provided on new master keyed orders; 1 each control key will be provided on new removable core or interchangeable core jobs; 6 each construction master keys and 1 construction control key will be provided for construction keyed orders.

Competitors Keyways

A selection of other manufacturer's keyways are available. Consult optional substitutions in each product section for availability. Not available for Hotel/Motel functions or factory master keyed.

Manufacturer	Keyway	Description	Option	Finish	Price
Best	See CK-8	See CK-8	See CK-8	See CK-8	See CK-8
Schlage*	C	6 pin, 0 bitted	SC-	Per product	NC
Schlage*	E	6 pin, 0 bitted	SE-	Per product	NC

*Mortise Cylinder size 41 ONLY and Rim Cylinder (#34) with SARGENT hold pattern. 2 each 6 Pin key blanks provided.

Option	Cylinder No.	Description	04/15
SC	C10-1	SC Cylinder - 11, 10, 8L, 7L, 6500 Lever Lock x SC (Schlage C keyway)	
SE	C10-1	SE Cylinder - 11, 10, 8L, 7L, 6500 Lever Lock x SE (Schlage E keyway)	\$94.00
SC	C480-1	SC Cylinder - 470, 480 (Schlage C keyway)	
SE	C480-1	SE Cylinder - 470, 481 (Schlage E keyway)	

Option	Cylinder No.	Description	03/04/10/10BE/10B/26/26D/BSP/WSP
SC	41	Schlage C 6 pin, 0 bitted 41 mort cyl. only	
SE	41	Schlage E 6 pin, 0 bitted 41 mort cyl. only	
SC	34	Schlage C 6 pin, 0 bitted 34 rim cylinder	\$96.00
SE	34	Schlage E 6 pin, 0 bitted 34 rim cylinder	

SARGENT hardware use SARGENT cylinders. SARGENT offers some competitor's keyways for use on certain SARGENT Hardware. These keyways are broached in barrels that are designed to operate in cylinders specific to SARGENT hardware. Note: All competitor keyway cylinders are NOT available in Hotel Functions.

CK-18 KESO F1 SECURITY SYSTEM

SARGENT
ASSA ABLOY

USA & Canada Prices Effective May 1, 2021

KESO F1 **KESO F1 codes are tightly controlled by the factory. End users signature required for keys & cylinders. All keying and key cutting is performed in a factory secure area.**

Note: KESO keys are not available Less Logo.

Keso F1 Security System Variations			
Option	Number	Description	Add to Set Price
F1	82	KESO F1 Security Cylinder	\$91.00 per Cylinder
F1	83	KESO F1 Security Removable Core Cylinders	\$130.00 per Cylinder
	84	KESO Security Removable Construction Core Cylinders	See Below

Above option numbers and price additions apply to 8 Line, 9 Line, 10 Line (82 Option only), Mortise Locks and Exit Devices only. Above price additions include all keying charges. Consult individual product catalog for availability.

Extra Keys	Extra Keys with locksets or cylinders	\$9.00 for extra key
------------	---------------------------------------	----------------------

Cut Keys			
Option	Number	Description	Price
F1	K372MK	Master Key	
F1	K372CHK	Day Key	
F1	K372CTL	Removable Core Control or Emergency Key for all cylinder locks except 8G50	\$11.00 Each
F1	K373EMK	Emergency Key Mortise	
F1	K374EMK	Emergency Key for 8G50	

KESO F1 cut keys are identified by the key number stamped on the bow of the key.

To place an order for cut keys, please be sure to include this number.

SARGENT will not be responsible for the function of the keys supplied using misidentified KESO F1 key numbers.

Please consult factory, if there are any questions, to verify that the stamp number is on file and to cross reference it to a keyset symbol.

KESO TEMPORARY CONSTRUCTION CORE – Same for KESO F1 and KESO key systems

(84-) The customer will be invoiced at \$65.00 NET/NET per construction core and the full invoice must be paid according to SARGENT's standard terms. No further discount will be applied. When construction cores are to be returned, the distributor must contact Customer Service for an RGA. Once the construction cores are returned to SARGENT, SARGENT will issue a \$63.00 credit for each construction core returned from the specified project.

Number	Description	Price
355CMK	Construction Day Key (84-)	\$11.00
355CTL	Construction Control Key (84-)	

Visual Key Control		
Stamping of cylinder concealed and/or two keys with industry standard alpha numeric keyset symbol		Add \$8.00 /cyl.
Each additional key		\$1.00 /key

Note: On new master keyed systems, removable and interchangeable core systems, and construction Master keyed system orders, please specify quantity of master keys, control keys, and master construction keys required. If order does not give quantities of key requirements, a minimum of 6 each master keys will be provided on new master keyed orders; 1 each control key will be provided on new removable core or interchangeable core jobs; 6 each construction master keys will be provided for construction keyed orders.

Experience a safer
and more open world

Copyright © 2002-2021 Sargent Manufacturing Company, an ASSA ABLOY Group company. All rights reserved. Reproduction in whole or in part without the express written permission of Sargent Manufacturing Company is prohibited. Contact us at: 800-727-5477 or visit www.sargentlock.com. In Canada contact us at: 800-461-3007 or visit www.assaabloydss.ca

8 Line, 9 Line & 10 Line - KESO F1 Security Cylinders – For use in locks prepared for KESO F1				Specify Finish
Option	Number	Description		04/15
F182	C8-1	All 8, 9 Line Functions (except 50 Function)		\$185.00
F182	C8-2	8, 9 Line #50 Function		\$230.00
F182	C10-1	All 7, 10 Line Functions (except 50 Function)		\$185.00
F182	C11-1	All 11 Line Functions (except 50 Function)		\$185.00
8 Line & 9 Line - KESO F1 Security Removable Cylinder – For use in locks prepared for KESO				Specify Finish
Option	Number	Description		04/15
F183	C8-1			\$224.00
Rim - KESO F1 Security Cylinders				Specify Finish
Option	Number	Description	US03/04/09/10/10B/10BE/10BL/20D/26/26D/32/32D/BSP/WSP	
F182	64	Rim Cylinder		\$187.00
Mortise - KESO F1 Security Cylinders				Specify Finish
Option	Number	Description	US03/04/09/10/10B/10BE/10BL/20D/32/32D/BSP/WSP	
F182	71, 72, 73, 74, 76	Regular cam		\$187.00
F182	72-115, 73-115	Hotel cam		\$187.00
F182	71-105, 72-105, 73-105, 74-105, 76-105	Cam for i/s of 78/8216 or 92 functions		\$187.00
F182	71-101 Thru 76-101	Adams Rite 1850 cam		\$187.00
F182	71-113 Thru 76-113	Keyswitch cam		\$187.00
F182	71-106 Thru 76-106	Schlage L cam		\$187.00
Integra Lock Cylinders				Specify Finish
Option	Number	Description	US03/04/09/10/10B/10BE/10BL/20D/32/32D/BSP/WSP	
F182		C7600-1		\$232.00
F183		C7600-1 (Removable core)		\$271.00

Note: Mortise & Rim cylinders are available in US3, 4, 9, 10, 10B, 10BE, 10BL, 14, 15, 20D, 32, 32D, BSP, WSP finishes. Cylinder plugs/barrels will be in either US4 or 15. Specify finish when ordering.

KESO F1 keysets are stamped on the cylinders in a concealed location.

For best results when ordering additional cylinders to the same keyset, please provide this stamped keyset on your order.

CK-20 KESO F1 SECURITY SYSTEM

SARGENT
ASSA ABLOY

CYLINDERS

USA & Canada Prices Effective May 1, 2021

Mortise Cylinders with Removable Cores Only (Not available for hotel functions)

Option	Number	Description	Specify Finish
F183	172, 173, 174, 176	Regular offset cam only	
F183	172-105, 173-105, 174-105, 176-105	Short cam (For 8216 & 8292 Lock Functions – Inside Cyl.)	\$226.00
F183	172-101 thru 176-101	Adams Rite cam (MS1850)	\$226.00

Removable Core Only – For Mortise Cylinders

Option	Number	Description	Specify Finish
F1	5172, 5173, 5174, 5176	Regular offset cam	
F1	5172-105, 5173-105, 5174-105, 5176-105	Short Cam (For 8216 & 8292 Lock Functions – Inside Cyl.)	\$130.00
F1	5172-101 thru 5176-101	Adams Rite Cam (MS1850)	\$130.00

Rim Cylinders with Removable Core

Option	Number	Description	Specify Finish
F183	164	Rim Cylinder	\$226.00

Removable Core Only – For Rim Cylinders

Option	Number	Description	Specify Finish
F1	5164	Rim Cylinder	\$130.00

KESO Cylinder Cams

Number	Description	Specify Finish
13-2563	For use with SARGENT KESO F1 cylinders 71 thru 76 and 172 thru 176. All functions except 50	\$5.51
13-2283	For use with 50 Lock Function.	\$28.25
13-2522	For use on inside cylinder of 78/8216 or 92 Function	\$10.46

Note: Mortise & Rim cylinders are available in US3, 4, 9, 10, 10B, 10BE, 10BL, 14, 15, 20D, 32, 32D, BSP, WSP finishes.
Cylinder plugs/barrels will be in either US4 or 15. Specify finish when ordering.
Mortise/Rim Removable Core Cylinder - Housings ONLY, crews and back plate to be ordered separately.

Mortise/Rim Removable Core Cylinder - Housings ONLY, screws and back plate to be ordered separately.

Number	Description	Price
072, 073, 074, 076 -	Mortise Housing only	\$98.00
*064 -	Rim Housing only	

* screws (part #13-0074 -2 required) and back plate (part #13-0086) - 1 required)

Removable Construction Core ONLY - for Mortise/Rim Cylinders

Mortise	Price
5472, 5473, 5474, 5476 - for Mortise type cylinder	
5472-105, 5473-105, 5474-105, 5476-105 - for Mortise type cylinder x short offset cam	
5472-101, 5473-101, 5474-101, 5476-101 - for Mortise type cylinder x Adams Rite Cam(MS1850)	\$130.00
5464 - for Rim type cylinder	

Experience a safer
and more open world

Copyright © 2002-2021 Sargent Manufacturing Company, an ASSA ABLOY Group company. All rights reserved.
Reproduction in whole or in part without the express written permission of Sargent Manufacturing Company is prohibited.
Contact us at: 800-727-5477 or visit www.sargentlock.com. In Canada contact us at: 800-461-3007 or visit www.assaabloydss.ca

UL LISTED CYLINDERS/CAMS/PADLOCKS

USA & Canada Prices Effective May 1, 2021

UL Listed KESO F1 Security Cylinders			Price
Option	Number	Description	10/26/26D
F1	4252	Utility Lock – Flat Cam	\$266.00
F1	4252-2	Utility Lock – Offset Cam	\$266.00
F1	4253	Switch Lock – Available in 26 Finish Only	\$339.00
F1	4264	Rim Cylinder	\$208.00
F1	4271, 4272,4273,4274,4276	Mortise Cylinder	\$208.00
F1	4271-106		\$233.00
Cam			Price
Number	Description		
13-2563	Regular offset cam		\$5.51
13-2283	Hotel cam (-115)		\$28.25
13-2522	Short offset cam (-105)		\$10.46
13-2521	Adams Rite MS 1850 cam (-101)		
13-2519	Key Switch		\$18.96
13-0939	Schlage L cam (-106)		
16-0129	4152 Cam		\$4.38
16-0146	4152-2 Cam		\$11.06
Utility Locks			Price
Option	Number	Description	03/04/10/26/26D
F1	4152	Flat cam	\$242.00
F1	4152-2	Offset cam	
Switch Lock			Price
Option	Number		26
F1	4153		\$315.00
Miscellaneous			Price Each
		Qty. Per Bag	
13-0080	Rim Cylinder Plug Retaining Ring	25	\$1.71
13-0085	Flat Tail Piece	25	
Padlocks			Specify Finish
Option	Number	Description	(04 only)
F182	856	Key can be removed while in the unlocked position	
F182	857	Key Removable in Locked Position Only	
F182	856C	Stainless Shackle with 9" chain	
F182	857C	Key retaining Key Removable in Locked Position Only with 9" chain	
F182	856HS	Hardened Steel Shackle	\$201.00
F182	857HS	Hardened Steel Shackle Key Removable in Locked Position Only	
F182	856HSC	Hardened Steel Shackle with 9" chain	
F182	857HSC	Hardened Steel Shackle with 9" chain Key Removable in Locked Position Only	

CYLINDERS

USA & Canada Prices Effective May 1, 2021

Guarantee

The SARGENT KESO F1 Cylinders are guaranteed for a period of one year from date of installation against defective workmanship, material or wear.

This guarantee is based on all items being installed in accordance with templates and installation instructions, and does not include products damaged as a result of misapplication or vandalism.

The following charges will apply for cylinders sent to the Service Center for repair.

Type of Repair	List Price
SARGENT Error	No Charge
Pin Wear within 1-yr guarantee	No Charge
Pin Wear outside guarantee	Price of new cylinder
Field Misuse	Price of new cylinder

Note: Out of warranty repair requests must be accompanied with a purchase order covering repair charges.

Repair product should be sent via a trackable carrier to:

SARGENT Manufacturing Company
P.O. Box 9725
100 Sargent Drive
New Haven, CT 06536

ATTN: KESO F1 Security Service Center

KESO **KESO codes tightly controlled by the factory, end users signature required for keys & cylinders. All keying and key cutting performed in a factory secure area. Available for existing systems only.**

Note: KESO keys and keyblanks are not available Less Logo.

Keso Security System Variations		
Option	Description	Add to Set Price
82	KESO Security Cylinder	\$91.00 per Cylinder
83	KESO Security Removable Core Cylinders	\$130.00 per Cylinder
84	KESO Security Removable Construction Core Cylinders	See Below

Above option numbers and price additions apply to 8 Line, 9 Line, 10 Line (82 Option only), Mortise Locks and Exit Devices only. Above price additions include all keying charges.

Extra Keys with locksets or cylinders \$9.00 for extra key

Cut Keys		
Number	Description	Price
372MK	Master Key	
372CHK	Day Key	
372CTL	Removable Core Control or Emergency Key for all cylinder locks except 8G50	\$11.00 Each
373EMK	Emergency Key	
374EMK	Emergency Key for 8G50	

Keyblanks			
Number	Description	Price	Keys Per Box
375	Control Keyblank	\$5.00 /ea.	25
376	Master and Change Keyblank	\$5.00 /ea.	25

KESO cut keys are identified by the key number stamped on the bow of the key.

To place an order for cut keys, please be sure to include this number.

SARGENT will not be responsible for the function of the keys supplied using misidentified KESO key numbers.

Please consult factory, if there are any questions, to verify that the stamp number is on file and to cross reference it to a keyset symbol.

KESO TEMPORARY CONSTRUCTION CORE

(84-) The customer will be invoiced at \$65.00 NET/NET per construction core and the full invoice must be paid according to SARGENT's standard terms. No further discount will be applied. When construction cores are to be returned, the distributor must contact Customer Service for an RGA. Once the construction cores are returned to SARGENT, SARGENT will issue a \$63.00 credit for each construction core returned from the specified project.

Number	Description	Price
355CMK	Construction Key	
355CTL	Construction Control Key	\$11.00

Note: On new master keyed systems, removable and interchangeable core systems, and construction Master keyed system orders, please specify quantity of master keys, control keys, and master construction keys required. If order does not give quantities of key requirements, a minimum of 6 each master keys will be provided on new master keyed orders; 1 each control key will be provided on new removable core or interchangeable core jobs; 6 each construction master keys will be provided for construction keyed orders.

CK-24 KESO SECURITY SYSTEM

SARGENT®

CYLINDERS

ASSA ABLOY

USA & Canada Prices Effective May 1, 2021

8 Line, 9 Line & 10 Line - Keso Security Cylinders – For use in locks prepared for KESO			Specify Finish 04/15
Option	Number	Description	Price
82	C8-1	All 8, 9 Line Functions (except 50 Function)	\$185.00
82	C8-2	8, 9 Line #50 Function	\$230.00
82	C10-1	All 7, 10 Line Functions (except 50 Function)	\$185.00
82	C11-1	All 11 Line Functions (except 50 Function)	\$185.00
8 Line & 9 Line - Keso Security Removable Cylinder – For use in locks prepared for KESO			Specify Finish 04/15
Option	Number	Description	Price
83	C8-1		\$224.00
Rim - Keso Security Cylinders		US03/04/09/10/10B/10BE/10BL/20D/32/32D/BSP/WSP	
Option	Number	Description	Price
82	64	Rim Cylinder	\$187.00
Mortise - Keso Security Cylinders		US03/04/09/10/10B/10BE/10BL/20D/32/32D/BSP/WSP	
Option	Number	Description	Price
82	71, 72, 73, 74, 76	Regular cam	
82	72-115, 73-115	Hotel cam	\$187.00
82	71-105, 72-105, 73-105, 74-105, 76-105	Cam for i/s of 78/8216 or 92 functions	
82	71-101 Thru 76-101	Adams Rite 1850 cam	\$187.00
82	71-113 Thru 76-113	Key Switch	\$187.00
82	71-106 Thru 76-106	Schlage L cam	\$187.00
Integra Lock Cylinders		03/04/09/10/10B/10BE/10BL/14/15/20D/26/26D/32/32D/BSP/WSP	
Option	Number	Description	Price
82	C7600-1		\$232.00
83	C7600-1	(Removable core)	\$271.00

Note: Mortise & Rim cylinders are available in US3, 4, 9, 10, 10B, 10BE, 10BL, 14, 15, 20D, 32, 32D, BSP, WSP finishes. Cylinder plugs/barrels will be in either US4 or 15. Specify finish when ordering.

KESO keysets are stamped on the cylinders in a concealed location.

For best results when ordering additional cylinders to the same keyset, please provide this stamped keyset on your order.

Mortise Cylinders with Removable Cores Only (Not available for hotel functions)			
Option	Number	Description	Price
83	172, 173, 174, 176	Regular offset cam only	\$226.00
83	172-105, 173-105, 174-105, 176-105	Short cam (For 8216 & 8292 Lock Functions – Inside Cyl.)	
83	172-101 Thru 176-101	Adams Rite cam (MS1850)	
Removable Core Only – For Mortise Cylinders			Price
Option	Number	Description	04/15
	5172, 5173, 5174, 5176	Regular offset cam	\$130.00
	5172-105, 5173-105, 5174-105, 5176-105	Short Cam (For 8216 & 8292 Lock Functions – Inside Cyl.)	
	5172-101 thru 5176-101	Adams Rite Cam (MS1850)	
Rim Cylinders with Removable Core			Price
Option	Number	Description	03/04/09/10/10B/10BE/10BL/20D/26/26D/32/32D/BSP/WSP
83	164	Rim Cylinder	\$226.00
Removable Core Only – For Rim Cylinders			Price
Option	Number	Description	04/15
	5164	Rim Cylinder	\$130.00
KESO Cylinder Cams			
Option	Number	Description	Price
	13-2563	For use with SARGENT KESO cylinders 71 thru 76 and 72 thru 176. All functions except 50	\$5.51
	13-2283	For use with 50 Lock Function.	\$28.25
	13-2522	For use on inside cylinder of 78/8216 or 92 Lock Function	\$10.46
Mortise/Rim Removable Core Cylinder - Housings ONLY			
Option	Number	Description	Price
	072, 073, 074, 076 -	Mortise Housing only	\$98.00
	*064 -	Rim Housing only	
* screws (part #13-0074 -2 required) and back plate (part #13-0086) - 1 required)			
Removable Construction Core ONLY - for Mortise/Rim Cylinders			
Mortise			Price
	5472, 5473, 5474, 5476 - for Mortise type cylinder		\$130.00
	5472-105, 5473-105, 5474-105, 5476-105 - for Mortise type cylinder x short offset cam		
	5472-101, 5473-101, 5474-101, 5476-101 - for Mortise type cylinder x Adams Rite Cam(MS1850)		
	5464 - for Rim type cylinder		

Note: Mortise & Rim cylinders are available in US3, 4, 9, 10, 10B, 10BE, 10BL, 14, 15, 20D, 32, 32D, BSP, WSP finishes. Cylinder plugs/barrels will be in either US4 or 15. Specify finish when ordering.

CK-26 KESO SECURITY SYSTEM

SARGENT®

UL LISTED CYLINDERS/CAMS/PADLOCKS

ASSA ABLOY

USA & Canada Prices Effective May 1, 2021

UL Listed Keso Security Cylinders			Price
Option Number	Description	10/26/26D	
4252	Utility Lock – Flat Cam	\$266.00	
4252-2	Utility Lock – Offset Cam	\$266.00	
4253	Switch Lock – Available in 26 Finish Only	\$339.00	
4264	Rim Cylinder	\$208.00	
4271, 4272, 4273, 4274, 4276	Mortise Cylinder	\$208.00	
4271-106		\$233.00	
Cam			Price
Number	Description		
13-2563	Regular Offset Cam	\$5.51	
13-2283	Hotel Cam (-115)	\$28.25	
13-2522	Short Offset Cam (-105)	\$10.46	
13-2521	Adams Rite MS 1850 Cam (-101)		
13-2519	Key Switch Clover Leaf Cam for 4370 Series	\$18.96	
13-0939	Schlage L Cam (-106)		
16-0129	4152 Cam	\$4.38	
16-0146	4152-2 Cam	\$11.06	
Utility Locks			
Option Number	Description	03/04/10/26/26D	
4152	Flat cam		
4152-2	Offset cam	\$242.00	
Switch Lock			26
4153		\$315.00	
Miscellaneous		Qty. Per Bag	Price Each
13-0080	Rim Cylinder Plug Retaining Ring	25	
13-0085	Flat Tail Piece	25	\$1.71
Padlocks			Finish
1" Shackle Standard, For 2.5", add -2 as suffix, For 4", add -4 as suffix			(04 Only)
Option	Number		
82	856	Key can be removed while in the unlocked position	
82	857	Key Removable in Locked Position Only	
82	856C	Stainless Shackle with 9" chain	
82	857C	"Key retaining" Key Removable in Locked Position Only with 9" chain	
82	856HS	Hardened Steel Shackle	\$201.00
82	857HS	Hardened Steel Shackle Key Removable in Locked Position Only	
82	856HSC	Hardened Steel Shackle with 9" chain	
82	857HSC	Hardened Steel Shackle with 9" chain Key Removable in Locked Position Only	

Experience a safer
and more open world

Copyright © 2002-2021 Sargent Manufacturing Company, an ASSA ABLOY Group company. All rights reserved.
Reproduction in whole or in part without the express written permission of Sargent Manufacturing Company is prohibited.
Contact us at: 800-727-5477 or visit www.sargentlock.com. In Canada contact us at: 800-461-3007 or visit www.assaabloydss.ca

Guarantee

The SARGENT KESO Cylinders are guaranteed for a period of one year from date of installation against defective workmanship, material or wear.

This guarantee is based on all items being installed in accordance with templates and installation instructions, and does not include products damaged as a result of misapplication or vandalism.

The following charges will apply for cylinders sent to the Service Center for repair.

Type of Repair	List Price
SARGENT Error	No Charge
Pin Wear within 1-yr guarantee	No Charge
Pin Wear outside guarantee	Price of new cylinder
Field Misuse	Price of new cylinder

Note: Out of warranty repair requests must be accompanied with a purchase order covering repair charges.

Repair product should be sent ADD to :

SARGENT Manufacturing Company
P.O. Box 9725
100 Sargent Drive
New Haven, CT 06536

ATTN: KESO Security Service Center

CYLINDERS & KEYING

USA & Canada Prices Effective May 1, 2021

Signature cylinders have the Signature Quill Logo embossed on the face of the cylinder barrel. Signature keys have SARGENT embossed on one side and the Signature Quill Logo, specific Signature code pattern and one additional line for stamping. Key blanks are also available blank one side. Consult the Signature catalog for more specific details. Please contact the factory for keyways available.

Please Note:

Signature products require a special ordering procedure. Please be sure that you include the following information when you send your order to Sargent for processing:

1. Keying Cover Sheet
2. Signature Cover Sheet with complete end user information and distributor information
3. Pin Coded/Letter of authorization from end user

Missing or incomplete information will cause delay in processing and may result in the return of your order. Forms may be obtained by contacting Sargent Customer Service at (800) 727-5477.

Signature Option (To be added to all applicable products, except where noted)		Price
10- Signature System*	Add	\$63.00 /cyl
Keying Charges & Substitutions		
Masterkeying charge is included in price of Removable Core cylinder (Option 10-63-)		
Double cylinder locks - Double below charges when purchased with locksets or exit devices		
Masterkeying or Higher level of keying, any quantity	Add	\$16.00 /cyl.
Masterkeying or Higher level of keying, any quantity, cylinders only		
Construction Masterkeying with lockset or exit devices (Option 21-)		
Construction Masterkeying with lockset or exit devices, cylinders only (Option 21-)		
Keys		
Option	Number	Description
10	S6272MK	Masterkey and/or Grandmasterkey
10	S6272CMK	Construction Masterkey
10	S6272CTL	Control Key – 6 Pin
10	S6272CHK	Change (Day) Key – 6 Pin
		\$12.00 /key
Extra Keys (Cylinders are packed standard with 2 keys each)		
For each extra day key ordered with lockset, exit device or cylinder		\$9.00 /key
Keys packed separately (indicate appropriate "Ship To" address on keying cover sheet)	Add	\$3.00 /cyl.
Keyblanks 50 Keys/Box. Must order multiple of 50 keys.		
Composite master sections 6 Pin 10-S6270		\$7.10 / key
Composite master sections 6 Pin 10-S6270 Unpublished restricted		\$8.10 / key
Single change/day sections 6 Pin 10-S6275		\$7.10 / key
Single change/day sections 6 Pin 10-S6275 Unpublished restricted		\$8.10 / key
Key Marking (Special marking is limited to space on blank side of keyblank)		
Stamping letters or numerals on key bow - add per each letter or numeral	Add	\$1.00 /num
"Do Not Duplicate" or other stamps on file at Sargent		No Addition
Where new special stamping is required i.e., "State of Alaska - Do Not Duplicate"	Add	\$840.00 /die
Keys stamped from this special die on first order only	Add	\$4.00 /key
Visual Key Control (When ordered with non-Signature product, the following applies to all)		
Signature Keys include visual key control (keys are stamped, cylinder face can not be stamped)		N/C
Non-Signature product requiring visual key control when ordered with Signature product		See CK-3
Concealed stamping of Rim or Mortise slide	Add	\$8.00
Concealed stamping of 10-6300 slide	Add	\$8.00
Note: VKC not available with Signature plugs		
Delete SARGENT Logo		
To delete SARGENT Logo from Keys – N/A for IC, XC, KESO		Consult factory for additional cost and leadtime
To delete SARGENT Logo from Extra Keys		
To delete SARGENT Logo from SARGENT Mortise & Rim Cylinders		

*Note: Available in the following Sargent keyway families – L, R
Refer to CK-3 for pricing and prior authorization requirements.



USA & Canada Prices Effective May 1, 2021

Note: Mortise & Rim cylinders are available in US3, 4, 9, 10, 10B, 10BE, 10BL, 20D, 32, 32D, BSP, WSP finishes.
Cylinder plugs/barrels will be in either US4 or 15. Specify finish when ordering.

Removable Core Cylinder (The Signature option add has already been included)		Price
Number		Specify Finish
10-6334, 10-6342, 10-6343, 10-6344, 10-6346	6 Pin only	\$242.00

Removable Cores Only (The Signature option add has already been included)		Price
Assembled		Specify Finish
10-6300	For All Except 50 Function	\$146.00

NOTE: 65- unassembled is not available with Signature cores. Available 1-bitted only.

*Mortise Cylinders with following Cams		Price
101	For Adams Rite – 1850, 4700	
105	Sargent Short Cam - for inside of 78/8216 & 92 functions	
106	For Schlage L	No Addition
112	“Open” Misc. Wide Straight Cam	
113	For 4370 Key Switch	

* Cams must be ordered with cylinders – permanently attached at the factory

Note: Construction Cores are available. Refer to CK-2 for Policy & Pricing. If ordering in “C” or “H” and or “G” keyway family, please consult factory.

Parts		Price
13-0985	Blocking Bar (Old Style)	\$7.73
13-1109	Blocking Bar (New Style)	\$20.07
13-0986	Blocking Bar Spring	\$0.10
13-0977	Body for 10-6300	\$41.19
13-0797	Slide for 6300 made before 3/06 with box logo (Price/pack - 100 slides)	\$43.70
13-0976	Barrel for 10-6300	\$104.52
13-1074	Sleeve for 6300 & 10-6300	\$0.68
13-1341	Slide for 6300 made after 3/06 (Price/pack - 100 slides)	\$43.70
437S	Signature Re-keying Kit	\$924.00
437RC	Re-keying Kit (Conventional & Signature) for removable Cores used in factory master keyed cylinders before January 2009	\$434.00
13-1037	Loading Rod Blade (Signature)	\$15.41
13-1138	Loading Rod Blade (Signature)	\$15.41
18-0070	Cylinder Spray Lube	\$29.45
18-0435	Cylinder Cleaner/De-Icer	\$29.45

Signature Cylinder Pins (Optional for 437RC kit)		
Stainless Steel pins for Protected Signature Cylinders		
Price/Pack		Price/Pack =
Part. No.	Size	25 Pins
13-1210	1	
13-1211	2	
13-1212	3	
13-1213	4	
13-1214	5	\$97.00
13-1215	6	
13-1216	7	
13-1217	8	
13-1218	9	
13-1222	B-Driver	
13-1223	C-Driver	

For Sargent 6300 Removable Core & Signature		
Removable Core—for 3rd & 4th positions:		
Part. No.	Hollow Drivers	Price/Pack = 100 Pins
13-1229	3	\$50.00
13-1234	4	
13-1235	5	
13-1236	6	
13-1237	7	\$28.00
13-1238	8	
13-1239	9	
13-1240	10	

For Sargent 6300 Removable Core & Signature		
Removable Core—Parts:		
Part. No.	Miscellaneous	Price/Pack = 100 rings
13-0487	Hollow Driver Springs used in the 3rd and 4th chambers of factory keyed cores prior to 1/1/09	\$96.97
01-0660	Retaining Ring	\$96.97

MORTISE & RIM CYLINDERS

ASSA ABLOY

USA & Canada Prices Effective May 1, 2021

Note: Mortise & Rim cylinders are available in US3, 4, 9, 10, 10B, 10BE, 10BL, 20D, 32, 32D, BSP, WSP finishes.
 Cylinder plugs/barrels will be in either US4 or 15. Specify finish when ordering.

Mortise Cylinder 6 Pin(The Signature add is included)		
Number	Specify Finish	Price
10-41, 10-42, 10-43, 10-44, 10-46		\$159.00
10-48, 10-50, 10-52, 10-54		\$204.00
10-56		\$408.00

Note: Price does not include Masterkeying

Mortise Cylinders with following:		
Cam No.		Price
101	For Adams Rite 1850, 4700	
106*	For Schlage "L"	No Addition
112	"Open" Misc. - Wide Straight Cam	
113	For 4370 Key Switch Coverleaf Cam	

Mortise Cylinder (10-40 Series) Plug & Sidepin		
Ass'y	Specify Finish	Price
13-3835	41	
13-3836	42	
13-3837	43	\$113.30
13-3838	44	
13-3839	46	
13-3840	48	
13-3841	50	
13-3842	52	\$133.93
13-3843	54	
13-3844	56	

Mortise Cylinder(10-40 Series) Bodies			
Number	Specify Finish		Price
13-3726	41		
13-3727	42		
13-3728	43		\$61.17
13-3729	44		
13-3730	46		
13-3731	48		
13-3732	50		
13-3733	52		\$88.17
13-3734	54		
13-3735	56		

Rim Cylinder		Price
10-34		\$159.00

Note: Price does not include Masterkeying

Rim Cylinder (10-34 Series) Plug & Sidepin Ass'y		
Specify Finish		Price
13-3845	6 Pin	\$113.30

Note: Price does not include Masterkeying

Rim Cylinder (10-34 Series) Cylinder Body		
Specify Finish		Price
13-3847	6 Pin	\$56.02



11 Line Cylinder Assemblies			
Option	Number	Specify Finish US4 or 15	Price
10	C11-1	For all Except 50 Function	\$157.00
10, 8L, 7L, 6500 Lever Cylinder Assemblies			
Option	Number	Specify Finish US4 or 15	Price
10	C10-1	For all Except 50 Function	\$157.00
8, 9 Knob Line Cylinder Assemblies			
Option	Number	Specify Finish US4 or 15	Price
10	C8-1	For all Except 50 Function	\$157.00
8X Knob Line Cylinder Assemblies			
Option	Number	Specify Finish US4 or 15	Price
10	C8X-1	For all Except 50 Function	\$157.00
6 Line Cylinder Assemblies			
Option	Number	Specify Finish US4 or 15	Price
10	C6-1	6 Pin (S and N Knobs) For All Except 50 Function	\$157.00
10	C6-1B	6 Pin (B Knob) For All Except 50 Function	
Auxiliary Locks Cylinder Assemblies			
Option	Number	Specify Finish US4 or 15	Price
10	C480-1	474, 484	\$157.00
10	C480-2	485, 487	
10	C480-3	475, 486	
10	C460-1	464	
10	C460-2	465	
10	C750-1	758, 858	
Note: Above Cylinder Assembly prices do not include masterkeying.			
7600 Integrallock Cylinders (All functions except 26, 27, and 50)			
Option	Part #	Specify Finish US4 or 15	Price
10	*C7600-1	Signature	\$204.00
10-21	*C7600-1	Construction & Signature	\$236.00
Bored Lock Cylinder Plug & Sidepin Assemblies			
Plug No.	Specify Finish US4 or 15	Price	
13-3851	For 8L, 10, 11, 6500, 6L Lever Lines	\$113.30	
13-3850	For 8, 9 Knob Lines		
13-3849	For 460, 480 Series		
Bored Lock Cylinder Body			
Cyl. Body No.	Price		
13-3710	For 6L, 8L, 10, 11, 6500 Lever Lines		
13-3852	For 8, 9 Knob Lines	\$56.65	
13-3854	For 460/480 Series		

CK-32 CYLINDERS & KEYING

SARGENT®

DEGREE™ KEY SYSTEM

ASSA ABLOY

USA & Canada Prices Effective May 1, 2021

The SARGENT Degree utility, patented locking system meets the security objective for all the openings in a facility with any level of physical security desired. Degree offers three levels of security, all operated by one key, easing the administration of keys and blanks. Not compatible with existing Sargent key system.

Degree Key System - Option (to be added to all applicable products, except where noted in product catalogs)

Options	Description	Add
DG1	Patented Degree DG1 Key System	No addition
DG160	Hardware prepared for DG1-6300 Lg. Format IC cores, supplied with temporary plastic construction cores	No addition
DG163	Patented Degree DG1 Large Format Interchangeable Core Cylinder - Includes master keying charges	\$83.00
DG164	Hardware prepared for DG1-6300 Lg. Format IC cores, supplied with temporary keyed construction cores	\$83.00
DG2	Patented Degree DG2 Key System incorporating a locking sidebar	\$63.00/cyl.
DG260	Hardware prepared for DG2-6300 Lg. Format IC cores, supplied with temporary plastic construction cores	No addition
DG263	Patented Degree DG2 Large Format Interchangeable Core Cylinder - Includes master keying charges	\$146.00
DG264	Hardware prepared for DG2-6300 Lg. Format IC cores, supplied with temporary keyed construction cores	\$83.00
DG3	Patented Degree DG3 Key System incorporating a locking sidebar and UL437 listed	\$89.00/cyl.
DG360	Hardware prepared for DG3-6300 Lg. Format IC cores, supplied with temporary plastic construction cores	No addition
DG363	Patented Degree DG3 Large Format Interchangeable Core Cylinder - Includes master keying charges	\$172.00
DG364	Hardware prepared for DG3-6300 Lg. Format IC cores, supplied with temporary keyed construction cores	\$83.00

Notes: Available in Large Format Interchangeable Core (LIFC).

Keyway Family Available: T

SARGENT keyway family: T

Prior authorization from SARGENT key records is required before establishing new key system.

Keying Charges

	Add/Cylinder
Masterkeying or Higher level of keying, any quantity (Except LIFC)	
Masterkeying or Higher level of keying, any quantity, cylinder only	
Construction Masterkeying (21-) with cylinders only	\$16.00
Construction Masterkeying (21-) with lockset or exit device or cylinder	
Note: Multiple cylinder function locks - Add charges accordingly per cylinder.	

Visual Key Control

Stamping of keyset number and file number on Master keys standard	No Charge
Concealed stamping code (Keyset Symbol) on bored, mortise or rim cylinder slide	\$8.00
Concealed stamping of DG1, 2, 3 cores slide	\$8.00
Key Marking – Special marking is limited to space on blank side of key blank. Two lines maximum	Consult factory

Cut Master Type Keys

Option	Number	Description	Price Each
DG1	DG6272MK	Master Keys DG1	
DG1	DG6272CTL	Control Key for 6300s DG1	
DG1	DG6272CMK	Construction Masterkey (21-) DG1	\$9.00
DG1	DG6272CHK	Change (Day) Key DG1	
DG2	DS6272MK	Master Keys DG2	
DG2	DS6272CTL	Control Key for 6300s DG2	
DG2	DS6272CMK	Construction Masterkey (21-) DG2	\$19.00
DG2	DS6272CHK	Change (Day) Key DG2 & DG3	
DG3	DS6272MK	Master Keys DG3	
DG3	DS6272CTL	Control Key for 6300s DG3	\$19.00

Emergency Master Keys

	Price Each
DG1 DG6267EMK Bored locks	
DG1 DG7268EMK Mortise locks	\$9.00
DG1 DG7269EMK 63- cylinders in mortise locks	

Construction Keys DG1, DG2, DG3

	Price Each
6251CMK Construction Masterkey DG1, DG2, DG3 (64-)	
6251CTL Construction Control Key DG1, DG2, DG3 (64-)	\$9.00

Change Keyblanks – Packed 50 per Box Keyway Families Available

Options	Number	Description	Price Each
DG1	DG6275	TA, TB, TC, TE, TF, TG, TJ, TK, TL – DG1	\$3.00
DG2	DS6275	TA, TB, TC, TE, TF, TG, TJ, TK, TL – DG2/DG3	\$5.50
DG3	DS6275	TA, TB, TC, TE, TF, TG, TJ, TK, TL – DG3	\$5.50

Master Keyblanks – Sold Packed 50 per Box Keyway Families Available

DG1	DG6270	TD, TH, TM, TDH, THM, TN – DG1	\$3.00
DG2	DS6270	TD, TH, TM, TDH, THM, TN – DG2/DG3	\$5.50
DG3	DS6270	TD, TH, TM, TDH, THM, TN – DG3	\$5.50

Extra Keys – Cylinders are packed standard with 2 keys each

	Add
DG1 For each extra key ordered with locksets, exit devices or cylinders	\$5.00 per key
DG2 For each extra key ordered with locksets, exit devices or cylinders	\$9.00
DG3 For each extra key ordered with locksets, exit devices or cylinders	\$9.00
For keys packed separately	\$4.00 per cyl.

Two (2) cut change keys are provided per lockset or cylinder at no charge. Keyblanks cannot be substituted for cut keys. Double cylinder lockset when keyed alike on both sides receives 2 keys per lock.

Experience a safer
and more open world

Copyright © 2002-2021 Sargent Manufacturing Company, an ASSA ABLOY Group company. All rights reserved.
Reproduction in whole or in part without the express written permission of Sargent Manufacturing Company is prohibited.
Contact us at: 800-727-5477 or visit www.sargentlock.com. In Canada contact us at: 800-461-3007 or visit www.assaabloydss.ca

DEGREE™ KEY SYSTEM DG1 MORTISE, RIM, BORED LOCK, DEADBOLTS, INTEGRALOCK, AND PADLOCK CYLINDERS

USA & Canada Prices Effective May 1, 2021

Note: Mortise & Rim cylinder housings include #97 Rossette are available in the following finishes: 3, 4, 9, 10, 10B, 10BE, 10BL, 14, 15, 20D, 26, 26D, BSP, WSP. Bored Cylinder Assemblies, cylinder plugs/barrels are available in the following finishes: 4, 15.

DG1 Rim and Mortise Cylinder 6 Pin		
Option	Specify finish when ordering	Price
DG1	34	\$96.00
DG1	41, 42, 43, 44, 46	\$96.00

Note: Price does not include Masterkeying

Mortise Cylinders with following suffix cam number		
101	For Adams Rite 1850, 4700	No Addition
105	Sargent Short Cams I/S 78/82/16/92 functions	
106	For Schlage "L"	
113	For 4370 Key Switch Coverleaf Cam	
112	"Open" Misc. – Wide Straight Cam	

DG1 Hotel Type Mortise Cylinders – Consult Factory for existing system compatibility		Price
DG1 50-43/50-44	Hotel Cylinder (7850, 7950, 8250 only)	\$127.00

Degree Series Mortise Cylinders, Exposed Barrel Only		Specify Finish When Ordering Price
DG1-78	42, 43, 44	\$127.00

T-Zone (11Line) and 10L Cylinder Assemblies			
Option	Number	Description	Price
*DG1	C11-1	T-Zone cylinder - all functions except 50 function	\$94.00
*DG1	C11-2	11 Line 50 function	\$139.00
*DG1	C10-1	10, 7L, & 6500 lever lock cylinder- all functions except 50 function	\$94.00
*DG1	C10-2	10 Line 50 function	\$105.00

7L, 8L, 8XL & 9L Knob Lock Cylinder Assemblies and Components			
*DG1	C8-1	7, 8, 9 Knob Locks - all functions except 50 function	\$94.00
*DG1	C8-2	8L Knob Locks - 50 function	\$139.00
DG1	C8X-1	8X Knob Lock - All except 50 function	\$94.00

6L Knob Lock Cylinder Assemblies and Components			
*DG1	C6-1	6 Line knob lock (S & N knobs) - all functions except 50 function	\$94.00
*DG1	C6-1B	6L Knob Lock cylinder (B knob) - all functions except 50 function	

460/470/480 Cylinder Assemblies and Components			
DG1	C460-1	464 cylinder	\$94.00
DG1	C460-2	465 cylinder	
DG1	C480-1	474, 484 cylinder	
DG1	C480-2	485, 487	
DG1	C480-3	475, 486 cylinder	

7600 Integralock Cylinder Assemblies and Components			
*DG1	C7600-1	7600 Integra functions 04, 05, & 37	\$141.00

758/858 Padlock Cylinder Assemblies and Components			
*DG1	C750-1	758, 858 cylinder	\$94.00

CK-34 CYLINDERS & KEYING

SARGENT®

ASSA ABLOY

DEGREE KEY SYSTEM DG1 LARGE FORMAT IC CORE RIM & MORTISE CYLS. DG2 MORTISE & RIM CYLINDERS

USA & Canada Prices Effective May 1, 2021

Degree DG1 Large Format Interchangeable Core Cylinders

Note: Mortise & Rim cylinder housings include #97 Rossette are available in the following finishes: 3, 4, 9, 10, 10B, 10BE, 10BL, 14, 15, 20D 26, 26D, BSP, WSP. Bored Cylinder Assemblies, cylinder plugs/barrels are available in the following finishes: 4, 15.

DG1-6300 Series Large Format Interchangeable Core (LFIC) Cylinders		
Option	Description	Price
DG1-60	Degree DG1 Large Format Interchangeable Plastic Disposable Construction Core	No addition
DG1-63	Degree DG1 Large Format Interchangeable Core Cylinder - includes masterkeying charges	\$83.00
DG1-64	Degree DG1 Large Format Interchangeable Construction Core Cylinder	\$83.00

Note: Price includes Masterkeying

Cut Master Keys			
Options	Number	Description	Price Each
DG1	DG6272CTL	Control key	\$9.00
DG1	DG6272MK	Masterkey	

Degree DG1 LFIC Mortise & Rim Cylinders - Includes Master & Grand Master Keying Charges	Specify Finish Price	
Number	Cylinder Size	
DG1-63	34, 42, 43, 44, & 46 - 6 Pin Only	\$179.00
DG1-63-50	43 & 44 - Hotel type Mortise cylinder	\$210.00

Degree DG1 LFIC ONLY - Includes Master & Grand Master Keying Charges	Specify Finish Price	
Number	Cylinder Size	
DG1-6300	6-Pin only	\$83.00

Degree DG1 LFIC ONLY - Unassembled	Specify Finish Price	
Number	Cylinder Size	
DG1-65-6300	6-Pin only	\$73.00

Degree DG1 LFIC Mortise & Rim body only	Specify Finish Price	
Number	Cylinder Size	
DG1-60	34, 42, 43, 44, & 46 - 6 Pin Only	\$96.00
DG1-60-50	43 & 44 - Hotel type Mortise cylinder	\$127.00

*Cylinders with following Cams		
Cam No.	Description	
101	For Adams Rite 1850, 4700	No Addition
105	Sargent Short Cams I/S 78/82 (16 & 92) functions	
106	For Schlage "L"	
113	For 4370 Key Switch Coverleaf Cam	
112	"Open" Misc. - Wide Straight Cam	

Note: *Cams must be ordered with cylinders - permanently attached at the factory.

DG2 Rim and Mortise Cylinder 6 Pin		
Option	Specify finish when ordering	Price
DG2	34	\$159.00
DG2	41, 42, 43, 44, 46	

Note: Price does not include Masterkeying

Mortise Cylinders with following suffix cam no.		
Cam No.	Description	
101	For Adams Rite 1850, 4700	No Addition
105	Sargent Short Cams I/S 78/82/16/92 functions	
106	For Schlage "L"	
113	For 4370 Key Switch Coverleaf Cam	
112	"Open" Misc. - Wide Straight Cam	

Degree Series Mortise Cylinder Exposed Barrel Only		
Number	Size	Specify Finish Price
DG2-78	41, 42, 43	\$190.00

Experience a safer
and more open world

Copyright © 2002-2021 Sargent Manufacturing Company, an ASSA ABLOY Group company. All rights reserved.
Reproduction in whole or in part without the express written permission of Sargent Manufacturing Company is prohibited.
Contact us at: 800-727-5477 or visit www.sargentlock.com. In Canada contact us at: 800-461-3007 or visit www.assaabloydss.ca

DEGREE KEY SYSTEM DG2 BORED LOCK, DEADBOLTS, INTEGRALOCK, AND PADLOCK CYLINDERS DG2 LARGE FORMAT IC CORE CYLINDERS

USA & Canada Prices Effective May 1, 2021

DG2 Degree Level T-Zone (11 Line), 10L, 8L, 7L, 6L, 6500 Lever Lock Cylinder Assemblies and Components			Specify Finish Price
Option	Description		
DG2 C11-1	T-Zone cylinder - all functions except 50 function		
DG2 C10-1	10, 8L, 7L, 6500 lever lock cylinder- all functions except 50 function		\$157.00
7L, 8L, & 9L Knob Lock Cylinder Assemblies and Components			Price
Option	Description		
DG2 C8-1	7, 8, 9 Knob Locks - all functions except 50 function		\$157.00
DG2 C8X-1	Cylinder – 8X Knob Locks		
6L Knob Lock Cylinder Assemblies and Components			Price
Option	Description		
DG2 C6-1	6 Line knob lock (S & N knobs) - all functions except 50 function		\$157.00
DG2 C6-1B	6L Knob Lock cylinder (B knob) - all functions except 50 function		
460/470/480 Cylinder Assemblies and Components		Specify Finish Price	
Number	Description		
DG2 C460-1	464 cylinder		
DG2 C460-2	465 cylinder		
DG2 C480-1	474, 484 cylinder	\$157.00	
DG2 C480-2	485, 487 cylinder		
DG2 C480-3	475, 486 cylinder		
7600 Integralock Cylinder Assemblies and Components		Specify Finish Price	
Number	Size		
DG2 C7600-1	7600 Integra functions 04, 05, & 37	\$204.00	
758/858 Padlock Cylinder Assemblies and Components		Specify Finish Price	
Number	Size		
DG2 C750-1	758, 858 cylinder	\$157.00	
DG2-6300 Series Large Format Interchangeable Core (LFIC) Cylinders			Price
Option	Description		
DG2-60	Degree DG2 Large Format Interchangeable Plastic Disposable Construction Core		No Addition
DG2-63	Degree DG2 Large Format Interchangeable Core Cylinder - includes masterkeying charges		\$146.00
DG2-64	Degree DG2 Large Format Interchangeable Construction Core Cylinder		\$83.00
Note: Price includes Masterkeying			
Cut Master Keys			Price Each
Options	Number	Description	
DG2 DS6272CTL		Control key	\$19.00
DG2 DS6272MK		Masterkey	
Degree DG2 LFIC Mortise & Rim Cylinders - Includes Master & Grand Master Keying Charges			Specify Finish Price
Number	Cylinder Size		
DG2-63	34, 42, 43, 44, & 46 - 6 Pin Only		\$242.00
Degree DG2 LFIC ONLY - Includes Master & Grand Master Keying Charges			Specify Finish Price
Number	Cylinder Size		
DG2-6300	6-Pin only		\$146.00
Degree DG2 LFIC ONLY - Unassembled			Specify Finish Price
Number	Cylinder Size		
DG2-65-6300	6-Pin only		\$136.00
Degree DG2 LFIC Mortise & Rim body only - Includes Master & Grand Master Keying Charges			Specify Finish Price
Option Number	Cylinder Size		
DG2-60	34, 42, 43, 44, & 46 - 6 Pin Only		\$96.00
*Cylinders with following Cams			
101	For Adams Rite 1850, 4700		
105	Sargent Short Cams I/S 78/82 (16 & 92) functions		
106	For Schlage "L"		
113	For 4370 Key Switch Coverleaf Cam		No Addition
112	"Open" Misc. – Wide Straight Cam		
115	Sargent Removable (63-) Hotel (50-) Cam for 50-60/63-40 series cylinders		
Note: *Cams must be ordered with cylinders – permanently attached at the factory.			

CK-36 CYLINDERS & KEYING

SARGENT®

ASSA ABLOY

DEGREE KEY SYSTEM DG3 MORTISE, RIM AND BORED LOCK, D.BOLTS, INTEGRALOCK, AND PADLOCK CYLINDERS

USA & Canada Prices Effective May 1, 2021

Note: Mortise & Rim cylinder housings include #97 Rossette are available in the following finishes: 3, 4, 9, 10, 10B, 10BE, 10BL, 14, 15, 20D, 26, 26D, BSP, WSP. Bored Cylinder Assemblies, cylinder plugs/barrels are available in the following finishes: 4, 15.

Rim and Mortise Cylinder 6 Pin		Price
Option	Specify finish when ordering	
DG3	34	\$185.00
DG3	41, 42, 43, 44, 46	

Note: Price does not include Masterkeying

Mortise Cylinders with following suffix cam no.		Add/cyl
Cam No.		
101	For Adams Rite 1850, 4700	No Addition
105	Sargent Short Cams I/S 78/82 (16 & 92) functions	
106	For Schlage "L"	
113	For 4370 Key Switch Coverleaf Cam	
112	"Open" Misc. – Wide Straight Cam	

DG3 Degree Level T-Zone (11 Line), 10L, 8L, 7L, 6L, 6500 Lever Lock Cylinder Assemblies and Components		Specify Finish Price
Option	Description	
DG3 C11-1	T-Zone cylinder - all functions except 50 function	\$183.00
DG3 C10-1	10, 8L, 7L, 6500 lever lock cylinder- all functions except 50 function	

8L, 8X & 9L Knob Lock Cylinder Assemblies and Components		Specify Finish Price
Option	Description	
DG3 C8-1	9, 8L Knob Locks - all functions except 50 function	\$183.00
DG3 C8X-1	8X knob lock except 50 function	

6L Knob Lock Cylinder Assemblies and Components		Specify Finish Price
Option	Description	
DG3 C6-1	6 Line knob lock (S & N knobs) - all functions except 50 function	\$183.00
DG3 C6-1B	6L Knob Lock cylinder (B knob) - all functions except 50 function	

460/470/480 Cylinder Assemblies and Components		Specify Finish Price	7600 Integralock Cylinder Assemblies and Components		Specify Finish Price
Number	Description		Number	Size	
DG3 C460-1	464 cylinder	\$183.00	DG3 C7600-1	7600 Integra functions 04, 05, & 37	\$230.00
DG3 C460-2	465 cylinder				
DG3 C480-1	474, 484 cylinder				
DG3 C480-2	485, 487 cylinder				
DG3 C480-3	475, 486 cylinder				

Experience a safer
and more open world

Copyright © 2002-2021 Sargent Manufacturing Company, an ASSA ABLOY Group company. All rights reserved.
Reproduction in whole or in part without the express written permission of Sargent Manufacturing Company is prohibited.
Contact us at: 800-727-5477 or visit www.sargentlock.com. In Canada contact us at: 800-461-3007 or visit www.assaabloydss.ca

DEGREE KEY SYSTEM DG3 LARGE FORMAT IC CORE CYLINDERS

USA & Canada Prices Effective May 1, 2021

DG3-6300 Series Large Format Interchangeable Core (LFIC) Cylinders		Price
Option	Description	
DG3-60	Degree DG3 Large Format Interchangeable Plastic Disposable Construction Core	No addition
DG3-63	Degree DG3 Large Format Interchangeable Core Cylinder - includes masterkeying charges	\$172.00
DG3-64	Degree DG3 Large Format Interchangeable Construction Core Cylinder	\$83.00

Note: Price includes Masterkeying

Above options not available with 50 hotel function

DG3 cores must be used with DG3- housings to maintain the UL437 listing

Cut Master Keys			Price Each
Options	Number	Description	
DG3 DS6272CTL		Control key	\$19.00
DG3 DS6272MK		Masterkey	

Degree DG3 LFIC Mortise & Rim Cylinders - Includes Master & Grand Master Keying Charges		Specify Finish Price
Number	Cylinder Size	
DG3-63	34, 42, 43, 44, & 46 - 6 Pin Only	\$268.00

Degree DG3 LFIC ONLY - Includes Master & Grand Master Keying Charges		Specify Finish Price
Number	Cylinder Size	
DG3-6300	6-Pin only	\$172.00

Degree DG3 LFIC Mortise & Rim body only		Specify Finish Price
Option Number	Cylinder Size	
DG3-60	34, 42, 43, 44, & 46 - 6 Pin Only	\$96.00

*Cylinders with following Cams		
101	For Adams Rite 1850, 4700	No Addition
104	Adams Rite 4070, 4350, 4250, 4516, 4150	
105	Sargent Short Cams I/S 78/82 (16 & 92) functions	
106	For Schlage "L"	
113	For 4370 Key Switch Coverleaf Cam	
112	"Open" Misc. - Wide Straight Cam	

Note: *Cams must be ordered with cylinders – permanently attached at the factory.

Retrofit Parts/Tail Pieces required with hardware not ordered to accept Degreee Series 6300 core		
08-5265	10-60-63 8 Line Knob Parts Pack	\$43.20
10-3429	10, 7, 6500 Tail Piece & Retainer Pack	\$9.95
11-5003	11 Line "T-Zone" Tail Piece & Retainer Pack	\$9.10
13-5178	11-60-63-34 Rim Cylinder Parts Pack	\$38.78
16-2508	460 Series Cam Assembly	\$4.04
17-2632	758/858 Tail Piece & Retainer Pack	\$11.37
431-6	Shear Tool used to modify existing 60- Mortise cylinder housings to accept 11-6300 & DG1, DG2 -6300 series cores	\$452.00
436-1	Top Loading Kit	\$725.00
437DGM	Master Degree Pinning Kit	\$1,489.00
437DG1	Degree DG1 Pinning Kit	\$936.00

CK-38 CYLINDERS & KEYING

SARGENT®

ASSA ABLOY

DEGREE™ KEY SYSTEM DEGREE PINS AND PARTS

USA & Canada Prices Effective May 1, 2021

Conical Bottom Pins		
Part No.	Size	Price
DG-0027	0	
DG-0021	1	
DG-0022	2	\$19.00
DG-0023	3	(100 pins per pack)
DG-0024	4	
DG-0025	5	
DG-0026	6	

Driver Pins		
Part No.	Size	Price
DG-0051	1	
DG-0052	2	\$9.00
DG-0053	3	(100 pins per pack)
DG-0054	4	
DG-0055	5	
DG-0246	6	
DG-0041	9	
DG-0042	8	\$40.00
DG-0043	7	(100 pins per pack)
DG-0044	6	
DG-0045	5	
DG-0246	6	
DG-0247	7	
DG-0248	8	\$19.00
DG-0249	9	(100 pins per pack)
DG-0250	10	
DG-0251	11	
DG-0252	12	

Driver Pins for Bump Resistance		
Part No.	Size	Price
DG-0037	10	
DG-0031	9	
DG-0032	8	\$18.00
DG-0033	7	(100 pins per pack)
DG-0034	6	
DG-0035	5	
DG-0036	4	

DG2 & DG3 Bottom Pins – First 5 Positions		
Part No.	Size	Price
DG-0111	1L	
DG-0112	2L	
DG-0113	3L	
DG-0114	4L	
DG-0115	5L	
DG-0116	6L	
DG-0121	1C	
DG-0122	2C	\$44.00
DG-0123	3C	(100 pins per pack)
DG-0124	4C	
DG-0125	5C	
DG-0126	6C	
DG-0131	1R	
DG-0132	2R	
DG-0133	3R	
DG-0134	4R	
DG-0135	5R	
DG-0136	6R	

Miscellaneous Parts		Price (100 pins per pack)
Part No.	Description	
DG-0016	Screw	\$20.00
DG-0017	Compression Spring	\$35.00
DG-0059	Sidebar Spring	\$9.36
DG-0060	Slider Spring	\$11.44
DG-0097	Compression Spring - LFIC	\$38.00

Cams for Degree Mortise Cylinders in Sargent Keyways		
Part No.	Description	Price
DG-0001	Standard cam	
DG-0002	Short cam (-105) used with Sargent mortise functions 16 & 92 on the inside cylinder	
DG-0004	Adams Rite cam (-101) 1850, 4700	
DG-0005	Adams Rite short cam (-104) 4070, 4350, 4250, 4516, 4150	\$12.40
DG-0006	4370 Keyswitch cam (-113)	
DG-0007	Schlage "L" cam (-106)	
DG-0008	"Open" miscellaneous cam (-112)	
DG-2808	Hotel cam (-115) used in 78/8250 functions	

Experience a safer
and more open world

Copyright © 2002-2021 Sargent Manufacturing Company, an ASSA ABLOY Group company. All rights reserved. Reproduction in whole or in part without the express written permission of Sargent Manufacturing Company is prohibited. Contact us at: 800-727-5477 or visit www.sargentlock.com. In Canada contact us at: 800-461-3007 or visit www.assaabloydss.ca

TABLE OF CONTENTS

USA & Canada Prices Effective May 1, 2021

Bored Locks - How to Order	BL-1	7-Line Grade 2 Lever Lock	BL-34 - BL-41
T-Zone (11 Line)	BL-2 - BL-15	7-Line Options	BL-34
T-Zone Options	BL-2	7-Line: B, L, P Levers	BL-35
T-Zone B, L, P Levers	BL-3	7-Line Coastal Series Options	BL-36
T-Zone Options	BL-4	7-Line Coastal Series Y, G Levers.....	BL-37
T-Zone J Levers	BL-5	7-Line Levers.....	BL-38
T-Zone Lockbody Assemblies.....	BL-6 to BL-9	7-Line Coastal Series Levers	BL-39
T-Zone Levers & Roses	BL-10	7-Line Lockbody Assemblies	BL-40
T-Zone SL Levers	BL-11	7-Line Rose/Latches/Parts	BL-41
T-Zone Locking Sleeve Assemblies.....	BL-12 to BL-13	6500-Line Grade 2 Lever Cylindrical Lock	BL-42
T-Zone Locking Sleeve, Latch & Bearing Assemblies.....	BL-14	DL Series	BL-43 to BL-51
T-Zone Parts	BL-15	DL Series – A, B, E, F, J, L, P, W Levers.....	BL-43
10X-Line Grade 1 Lever Lock	BL-16 - BL-21	DL Series – Coastal Series.....	BL-44
10X-Line Options.....	BL-16	DL Series – Studio Collection Levers (Except Gramercy Series).....	BL-45
10X-Line: L, B, P, MB, MD, ND, MW Levers	BL-17	DL Series – Studio Collection Levers (Wooster Square).....	BL-46
10X-Line Levers	BL-18	DL Series – Studio Collection Levers (Wooster Square & Grant Park).....	BL-47
10X-Line: Roses/Latches/Assemblies.....	BL-19	DL Series – Studio Collection Levers - Gramercy Series.....	BL-48
10X-Line FW Lockbody Assemblies	BL-20	DL Series – Studio Collection Levers - Gramercy Series.....	BL-49
10X-Line Parts.....	BL-21	DL Series – SIMPLI™ Roseless Trim Coastal Series	BL-50
10-Line Grade 1 Lever Lock	BL-22 - BL-33	DL Series – SIMPLI™ Roseless Trim Studio Collection Levers.....	BL-51
10-Line Options	BL-22	8X Line Grade 1 Knob Lock	BL-52 - BL-53
10-Line: B, L, P Levers	BL-23	8X Line Grade 1 Options	BL-52
10-Line Options	BL-24	8X Line Grade 1 Knob Lock & Strikes	BL-53
10-Line: J Lever	BL-25	6-Line Grade 2 Knob Lock	BL-54 - BL-57
10-Line Coastal Series Options	BL-26	6-Line Options	BL-54
10-Line Coastal Series Y, G Levers.....	BL-27	6-Line – Knob Design.....	BL-55
10-Line Levers.....	BL-28	6-Line Latches/Parts	BL-56
10-Line Coastal Series Levers	BL-29	6-Line Parts	BL-57
10-Line Roses, Latches, Assemblies	BL-30		
10-Line Lockbody Assemblies	BL-31		
10-Line FW Lockbody Assemblies.....	BL-32		
10-Line Parts	BL-33		

How to Order

Step	Description	Example
Quantity	Each	10 Ea.
Option	Consult catalog for options available	10 Ea. 28-
Line	11, 10, 9, 8X, 7, 6, DL, RDL & 6500	10 Ea. 28- 11
Function	Consult catalog for functions available	10 Ea. 28- 11 G05
Design	Consult catalog for designs available	10 Ea. 28- 11G05 LL
Finish	Consult catalog for finishes available	10 Ea. 28- 11G05 LL US26D
Hand	Consult catalog for handing requirements	10 Ea. 28- 11G05 LL US26D RH
Split Finishes	Specify outside finish first	10 Ea. 28- 11G05 LL US26D/10B

ANSI Finish and Function Comparison

Function		Finish		
SARGENT	ANSI	SARGENT	ANSI	Description
U15	F75	US3	605	Polished Brass
U65	F76	US4	606	Satin Brass
G75	F78	US9	611	Polished Bronze
G75-2	F79	US10	612	Satin Bronze
G30	F80	US10B	613	Oxidized Satin Bronze / Oil Rubbed
G05	F81	US10BE	613E	Dark Oxidized Satin Bronze - Equivalent
G24	F82	US10BL	616	Oxidized Satin Bronze / Lacquered
G37	F84	US14	618	Polished Nickel, clear coated
G87	F85	US15	619	Satin Nickel Plate
G04	F86	US20D	622	Dark Statuary Bronze / Powder coated
G17	F87	US26	625	Polished Chrome
G16	F88	US26D	626	Satin Chrome
G13	F89	US32	629	Polished Stainless Steel
G54	F90	US32D	630	Satin Stainless Steel
G26	F91	BSP	n/a	Black Suede Powder Coat
G44	F92	WSP	n/a	White Suede Powder Coat
G50	F93	NL		No Lacquer

Notes:

For locks with non-ferrous material for marine use, please contact the factory.

BL-2 BORED LOCKS

SARGENT®

OPTIONS

ASSA ABLOY

USA & Canada Prices Effective May 1, 2021

Options	Description	Price
10▲	SARGENT Signature Key System	\$63.00 / cyl.
11▲	SARGENT XC Key System (not available with 10, 22, SC, SE options)	No addition
1160▲	Sargent XC Large Format Interchangeable Plastic Disposable Construction Core	No addition
1163▲	Sargent XC Large Format Interchangeable Core Cylinder - Includes masterkeying charges	\$83.00
1164▲	Sargent XC Large Format Interchangeable Construction Core Cylinder	\$83.00
1170	Small Format interchangeable disposable construction core - to accept 7 Pin XC permanent core	No addition
11727P	Small Format interchangeable keyed construction core - to accept 7 Pin XC permanent core	\$75.00
11737P	Small Format interchangeable core - to accept 7 pin XC permanent core	\$75.00 / cyl.
21▲	SARGENT Construction Key System (lost ball) Standard on all new systems est. since 5/1/96	\$16.00 / cyl.
22	SARGENT Construction Key System (split key) To be used on pre-est. split key system only	\$32.00 / cyl.
23	Lockset x 3-3/4" Backset	\$10.00
25	Lockset x 5" Backset	\$17.00
28	Lockset x ANSI A-156.115 Strike – 1-1/4" Lip Standard Lip Lengths 1-1/8" or 1-3/8" Lip Lengths 1-5/8", 1-7/8", 2-1/8", 2-3/8", 2-5/8", 2-7/8"	No addition \$11.00
30▲	Lever to accept Schlage cylinder - no cylinder provided	No addition
31▲	For 2-1/4" to 2-1/2" thick doors, centered in door prep, no paneling. Consult factory for other door thicknesses available by special application.	\$281.00
36	6 Lobe security head screws	\$15.00
37	Spanner head screws	\$10.00
41▲	Lockset x 3/4" Throw (04, 05, 13, 15-3, 16, 17, 30, 37, 38 Functions)	\$106.00
60▲	SARGENT Large Format Interchangeable Plastic Disposable Construction Core	No addition
63▲	SARGENT Large Format Interchangeable Core Cylinder includes master and grandmaster keying charge	\$83.00 / cyl.
64▲	SARGENT Large Format Interchangeable Construction Core Cylinder	\$83.00
6573▲	Small Format 6 Pin Uncombined Core	\$65.00 / cyl.
65737P▲	Small Format 7 Pin Uncombined Core	\$65.00 / cyl.
70▲	Small Format Interchangeable disposable plastic construction core	No addition
72▲	Small Format Interchangeable 6-pin Construction Core (7-Pin w/11- option)	\$75.00
73▲	Small Format Interchangeable Core, 6-Pin Includes MK and GMK keying charges	\$75.00 / cyl.
737P▲	Small Format Interchangeable Core, 7-Pin Includes MK and GMK keying charges	\$75.00 / cyl.
74	Lead Lining I/S Rose, O/S Rose, and Latch Tube	\$214.00 /lock
75	Tactile Warning - Milled on backside of inside lever	\$40.00
76	Tactile Warning - Milled on backside of outside lever	\$40.00
77	Tactile Warning - Milled on backside of both levers	\$80.00
80▲	Levers to accept KESO and Keso F1 cylinders – no cylinders provided	-\$94.00/cyl.
82▲	SARGENT KESO Security Cylinder (existing Key Systems only)	\$91.00 /cyl.
F182▲	SARGENT KESO Security Cylinder – patented –New Key Systems	\$91.00 /cyl.
85	Tactile Warning - Abrasive coating on inside lever	\$49.00
86	Tactile Warning - Abrasive coating on outside lever	\$49.00
87	Tactile Warning - Abrasive coating on both levers	\$98.00
BR	SARGENT Bump Resistant Cyls. (N/A w/10, 22, 30, 60, 63, 64, 70, 72, 73, 737P, KESO, SC, SE)	\$25.00 /cyl.
DG1	Patented Degree DG1 Key System	No addition
DG160	Hardware prepared for DG1-6300 Lg. Format IC cores, supplied with temporary plastic construction cores	No addition
DG163	Patented Degree DG1 Large Format Interchangeable Core Cylinder - Includes master keying charges	\$83.00
DG164	Hardware prepared for DG1-6300 Lg. Format IC cores, supplied with temporary keyed construction cores	\$83.00
DG2	Patented Degree DG2 Key System incorporating a locking sidebar	\$63.00/cyl.
DG260	Hardware prepared for DG2-6300 Lg. Format IC cores, supplied with temporary plastic construction cores	No addition
DG263	Patented Degree DG2 Large Format Interchangeable Core Cylinder - Includes master keying charges	\$146.00
DG264	Hardware prepared for DG2-6300 Lg. Format IC cores, supplied with temporary keyed construction cores	\$83.00
DG3	Patented Degree DG3 Key System incorporating a locking sidebar and UL437 listed	\$89.00/cyl.
DG360	Hardware prepared for DG3-6300 Lg. Format IC cores, supplied with temporary plastic construction cores	No addition
DG363	Patented Degree DG3 Large Format Interchangeable Core Cylinder - Includes master keying charges	\$172.00
DG364	Hardware prepared for DG3-6300 Lg. Format IC cores, supplied with temporary keyed construction cores	\$83.00
LC	Less Cylinder	-\$94.00/cyl.
SC▲	Schlage C keyway cylinder "0" bitted	No addition
SE▲	Schlage E keyway cylinder "0" bitted	No addition
SF	L Lever to accept Schlage Large Format Interchangeable Core (supplied less core, tailpiece included)	No Addition
SG	MicroShield® – an antimicrobial powder coat	\$73.00
SL	High Security Lever attachment (not available on non-keyed functions)	No addition
STC	STC 55 Acoustical Door System	No addition
VC	Lock provided to accept ASSA V-10 Interchangeable Core Cylinders. V-10 cylinders are available from ASSA, Inc @ 800-235-7482	No addition
WBS	Wrought Box Strike	No Addition
YC	L or P Lever to accept Yale® 6-pin fixed core cylinder	No addition
YC7P	L or P Lever to accept Yale® 7-pin fixed core cylinder	No addition
YRC	L or P Lever to accept Yale® 6-pin LFIC	No addition
YRC7P	L or P Lever to accept Yale® 7-pin LIFC	No addition
▲ Options	not available in 50 function.	
CPC	Clear Powder Coat over 26D – 11G05 x OL x 26D x CPC All orders will continue to be handled as a "special" when CPC is ordered.	\$67.00

Experience a safer
and more open world

Copyright © 2002-2021 Sargent Manufacturing Company, an ASSA ABLOY Group company. All rights reserved.
Reproduction in whole or in part without the express written permission of Sargent Manufacturing Company is prohibited.
Contact us at: 800-727-5477 or visit www.sargentlock.com. In Canada contact us at: 800-461-3007 or visit www.assaabloydss.ca

Rose Design:

- O Rose - 2-3/4" Dia. – Shown
- B Rose - 2-3/4" Dia. – Shown
- L Rose - 3-1/2" Dia.
- E Rose - 3-1/8" Sq. – Shown

Lever Design:

- B – Shown
- L – Shown
- P – Shown



OL

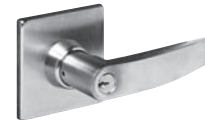

EB



BP

Function		Finish	
		10BE/26D/BSP/WSP	03/04/09/10/10B/10BL/14/15/20D/26
Single Cylinder			
11G04	Storeroom/Closet		
11G05	Entry/Office	\$750.00	\$766.00
11G37	Classroom		
11G24	Entry	\$766.00	\$782.00
11G44	Service Station		
11G50	Hotel	\$842.00	\$858.00
11G54	Dormitory		
Double Cylinder			
11G16	Classroom Security/Public Entrance		
11G17	Utility/Asylum/Institutional	\$880.00	\$896.00
11G30	Communicating		
* 11G38	Classroom Security		
Non Keyed			
11U15	Passage	\$558.00	\$574.00
11G13	Exit		
11G15-3	Exit	\$636.00	\$652.00
11U65	Privacy		
11U68	Hospital/Privacy		
11U93	Dummy Trim	\$251.00	\$259.00
11U94	Dummy Trim	\$492.00	\$508.00
11U94-2	Dummy Trim	\$499.00	\$515.00

Note: Split finishes are available, price as higher finish. Order outside/inside and handing must be specified. Strike and latch front will match inside finish for RH/LH and outside finish for RHR/LHR.

Strokes – See catalog for available lip lengths		Specify Finish
800	ANSI A115.2 T Strike (Standard) Lip Lengths available: 1", 1-1/4" (Standard), 1-1/2", 1-3/4", 2"	Refer to page BL-53
808	ANSI A115.2 – 4-7/8" Strike (Option 28-) Lip Lengths available: 1-1/8", 1-1/4" (Standard), 1-3/8", 1-5/8", 1-7/8", 2-1/8", 2-3/8", 2-5/8", 2-7/8"	Refer to page BL-53
AM-0044	Strike Box (Standard)	\$12.00
77-1141	Strike Box (Option 28-)	\$12.00

*Not available on B rose design

BL-4 BORED LOCKS

SARGENT®

J OPTIONS

ASSA ABLOY

USA & Canada Prices Effective May 1, 2021

Options	Description	Price
10▲	SARGENT Signature Key System	\$63.00 / cyl.
11▲	SARGENT XC Key System (not available with 10, 22, SC, SE options)	No addition
1160▲	Sargent XC Large Format Interchangeable Plastic Disposable Construction Core	No addition
1163▲	Sargent XC Large Format Interchangeable Core Cylinder - Includes masterkeying charges	\$83.00
1164▲	Sargent XC Large Format Interchangeable Construction Core Cylinder	\$83.00
21▲	SARGENT Construction Key System (lost ball) Standard on all new systems est. since 5/1/96	\$16.00 / cyl.
22	SARGENT Construction Key System (split key) To be used on pre-est. split key system only	\$32.00 / cyl.
23	Lockset x 3-3/4" Backset	\$10.00
25	Lockset x 5" Backset	\$17.00
28	Lockset x ANSI A-156.115 Strike – 1-1/4" Lip Standard Lip Lengths 1-1/8" or 1-3/8" Lip Lengths 1-5/8", 1-7/8", 2-1/8", 2-3/8", 2-5/8", 2-7/8"	No addition \$11.00
30▲	Lever to accept Schlage cylinder - no cylinder provided	No addition
31▲	For 2-1/4" to 2-1/2" thick doors, centered in door prep, no paneling. Consult factory for other door thicknesses available by special application.	\$281.00
36	6 Lobe security head screws	\$15.00
37	Spanner head screws	\$10.00
41▲	Lockset x 3/4" Throw (04, 05, 13, 15-3, 16, 17, 30, 37, 38 Functions)	\$106.00
60▲	SARGENT Large Format Interchangeable Plastic Disposable Construction Core	No addition
63▲	SARGENT Large Format Interchangeable Core Cylinder includes master and grandmaster keying charge	\$83.00 / cyl.
64▲	SARGENT Large Format Interchangeable Construction Core Cylinder	\$83.00
6573▲	Small Format 6 Pin Uncombined Core	\$65.00 / cyl.
65737P▲	Small Format 7 Pin Uncombined Core	\$65.00 / cyl.
70▲	Small Format Interchangeable disposable plastic construction core	No addition
72▲	Small Format Interchangeable 6-pin Construction Core (7-Pin w/11- option)	\$75.00
73▲	Small Format Interchangeable Core, 6-Pin Includes MK and GMK keying charges	\$75.00 / cyl.
737P▲	Small Format Interchangeable Core, 7-Pin (refer to CK-12 for available keyways) Includes MK and GMK keying charges	\$75.00 / cyl.
74	Lead Lining I/S Rose, O/S Rose, and Latch Tube	\$214.00 /lock
75	Tactile Warning - Milled on backside of inside lever	\$40.00
76	Tactile Warning - Milled on backside of outside lever	\$40.00
77	Tactile Warning - Milled on backside of both levers	\$80.00
80▲	Levers to accept KESO and Keso F1 cylinders – no cylinders provided	-\$94.00/cyl.
F182▲	SARGENT KESO Security Cylinder – patented –New Key Systems	\$91.00 /cyl.
82▲	SARGENT KESO Security Cylinder (existing Key Systems only)	\$91.00 /cyl.
85	Tactile Warning - Abrasive coating on inside lever	\$49.00
86	Tactile Warning - Abrasive coating on outside lever	\$49.00
87	Tactile Warning - Abrasive coating on both levers	\$98.00
BR	SARGENT Bump Resistant Cyls. (N/A w/10, 22, 30, 60, 63, 64, 70, 72, 73, 737P, KESO, SC, SE)	\$25.00 /cyl.
DG1	Patented Degree DG1 Key System	No addition
DG160	Hardware prepared for DG1-6300 Lg. Format IC cores, supplied with temporary plastic construction cores	No addition
DG163	Patented Degree DG1 Large Format Interchangeable Core Cylinder - Includes master keying charges	\$83.00
DG164	Hardware prepared for DG1-6300 Lg. Format IC cores, supplied with temporary keyed construction cores	\$83.00
DG2	Patented Degree DG2 Key System incorporating a locking sidebar	\$63.00/cyl.
DG260	Hardware prepared for DG2-6300 Lg. Format IC cores, supplied with temporary plastic construction cores	No addition
DG263	Patented Degree DG2 Large Format Interchangeable Core Cylinder - Includes master keying charges	\$146.00
DG264	Hardware prepared for DG2-6300 Lg. Format IC cores, supplied with temporary keyed construction cores	\$83.00
DG3	Patented Degree DG3 Key System incorporating a locking sidebar and UL437 listed	\$89.00/cyl.
DG360	Hardware prepared for DG3-6300 Lg. Format IC cores, supplied with temporary plastic construction cores	No addition
DG363	Patented Degree DG3 Large Format Interchangeable Core Cylinder - Includes master keying charges	\$172.00
DG364	Hardware prepared for DG3-6300 Lg. Format IC cores, supplied with temporary keyed construction cores	\$83.00
LC	Less Cylinder	-\$94.00/cyl.
SC▲	Schlage C keyway cylinder "0" bitted	No addition
SE▲	Schlage E keyway cylinder "0" bitted	No addition
SG	MicroShield® – an antimicrobial powder coat	\$73.00
SL	High Security Lever attachment (not available on non-keyed functions)	No addition
STC	STC 55 Acoustical Door System	No addition
VC	Lock provided to accept ASSA V-10 Interchangeable Core Cylinders. V-10 cylinders are available from ASSA, Inc @ 800-235-7482	No addition
WBS	Wrought Box Strike	No Addition
▲ Options	not available in 50 function.	
CPC	Clear Powder Coat over 26D – 11G05 x OL x 26D x CPC All orders will continue to be handled as a "special" when CPC is ordered.	\$67.00

Experience a safer
and more open world

Copyright © 2002-2021 Sargent Manufacturing Company, an ASSA ABLOY Group company. All rights reserved.
Reproduction in whole or in part without the express written permission of Sargent Manufacturing Company is prohibited.
Contact us at: 800-727-5477 or visit www.sargentlock.com. In Canada contact us at: 800-461-3007 or visit www.assaabloydss.ca

Rose Design:

- O Rose - 2-3/4" Dia.
- B Rose - 2-3/4" Dia.
- L Rose - 3-1/2" Dia. – Shown
- E Rose - 3-1/8" Sq.

Lever Design:

J – Shown



LJ

Function		Finish	
		10BE/26D/BSP/WSP	03/04/09/10/10B/10BL/14/15/20D/26
Single Cylinder			
11G04	Storeroom/Closet		
11G05	Entry/Office	\$771.00	\$787.00
11G37	Classroom		
11G24	Entry	\$791.00	\$807.00
11G44	Service Station		
11G50	Hotel	\$863.00	\$879.00
11G54	Dormitory		
Double Cylinder			
11G16	Classroom Security/Public Entrance		
11G17	Utility/Asylum/Institutional	\$901.00	\$917.00
11G30	Communicating		
11G38	Classroom Security		
Non Keyed			
11U15	Passage	\$584.00	\$600.00
11G13	Exit		
11G15-3	Exit	\$663.00	\$679.00
11U65	Privacy		
11U68	Hospital/Privacy		
11U93	Dummy Trim	\$261.00	\$269.00
11U94	Dummy Trim	\$516.00	\$532.00
11U94-2	Dummy Trim	\$521.00	\$537.00

Note: Split finishes are available, price as higher finish. Order outside/inside and handing must be specified. Strike and latch front will match inside finish for RH/LH and outside finish for RHR/LHR.

Strokes – See catalog for available lip lengths		Specify Finish
800	ANSI A115.2 T Strike (Standard) Lip Lengths available: 1", 1-1/4" (Standard), 1-1/2", 1-3/4", 2"	Refer to page BL-53
808	ANSI A115.2 – 4-7/8" Strike (Option 28-) Lip Lengths available: 1-1/8", 1-1/4" (Standard), 1-3/8", 1-5/8", 1-7/8", 2-1/8", 2-3/8", 2-5/8", 2-7/8"	Refer to page BL-53
AM-0044	Strike Box (Standard)	\$12.00
77-1141	Strike Box (Option 28-)	\$12.00

BL-6 BORED LOCKS

SARGENT®

Tone™ LOCK BODY ASSEMBLIES

ASSA ABLOY

USA & Canada Prices Effective May 1, 2021

Lock Body Assemblies - For non-cylinder and standard cylinder and 10-, 21-, 22-, 30- SC-, SE-		
Part No	Function	Price
11-2294	04	
* 11-2295	05	\$340.16
11-2304	37	
* 11-2301	24	
* 11-2305	44	\$372.80
* 11-2307	54	
* 11-2306	50	\$379.88
11-2299	16	
11-2300	17	\$401.19
11-2303	30	
11-2311	38	
11-2297	15	\$255.61
11-2296	13	
11-2298	15-3	\$301.80
* 11-2308	65, 68	
Lock Body Assemblies - 41- Option For non-cylinder and standard cylinder and 10-, 21-, 22-, 30- SC-, SE-		
Part No	Function	Price
11-2337	04	
* 11-2338	05	\$394.08
11-2342	37	
11-2341	16	\$450.88
11-2340	15-3	\$351.46
11-2339	15	\$305.30
Lock Body Assemblies - For Removable (60-) and Interchangeable Core (70-) Cylinder Functions		
Part No	Function	Price
11-2349	04	
* 11-2350	05	\$355.05
11-2355	37	
* 11-2353	24	
* 11-2356	44	\$383.41
* 11-2358	54	
11-2351	16	
11-2352	17	\$411.83
11-2354	30	
11-2361	38	
Lock Body Assemblies - 41- Option - For Removable (60-) and Interchangeable Core (70-) Cylinder Functions		
Part No	Function	Price
11-2380	04	
* 11-2381	05	\$404.73
11-2383	37	
* 11-2382	16	\$461.54

Note: Lockbodies are shipped with bearing assembly, inside & outside sleeve, and inside & outside collar.

* Specify finish when ordering.

Lock Body Assemblies - For 82- KESO cylinder functions

Part No	Function	Price
11-2426	04	
* 11-2427	05	\$362.13
11-2432	37	
* 11-2430	24	
* 11-2434	44	\$390.54
* 11-2435	54	
11-2428	16	
11-2429	17	\$418.92
11-2431	30	
11-2433	38	

Lock Body Assemblies - For 41- Option - For 82- KESO cylinder functions

Part No	Function	Price
11-2585	04	
* 11-2586	05	\$411.83
11-2588	37	
* 11-2587	16	\$468.64

Note: Lockbodies are shipped with bearing assembly, inside & outside sleeve, and inside & outside collar.

* Specify finish when ordering

BL-8 BORED LOCKS

SARGENT®

TZone™ SL LOCK BODY ASSEMBLIES

ASSA ABLOY

USA & Canada Prices Effective May 1, 2021

SL-Lock Body Assemblies - For non-cylinder and standard cylinder and 10-, 21-, 22-, 30- SC-, SE-		
Part No	Function	Price
11-2672	04	
* 11-2673	05	\$344.39
11-2678	37	
* 11-2676	24	
* 11-2680	44	\$372.80
* 11-2682	54	
* 11-2681	50	\$379.88
11-2674	16	
11-2675	17	
11-2677	30	\$401.19
11-2679	38	
SL-Lock Body Assemblies - 41- Option For non-cylinder and standard cylinder and 10-, 21-, 22-, 30- SC-, SE-		
Part No	Function	Price
11-2696	04	
* 11-2697	05	\$394.08
11-2699	37	
11-2698	16	\$450.88
SL-Lock Body Assemblies - For removable (60-) core cylinder functions		
Part No	Function	Price
11-2700	04	
* 11-2701	05	\$355.05
11-2706	37	
* 11-2704	24	
* 11-2708	44	\$383.43
* 11-2709	54	
11-2702	16	
11-2703	17	
11-2705	30	\$411.83
11-2707	38	
SL-Lock Body Assemblies - 41- Option - For removable (60-) core cylinder functions		
Part No	Function	Price
11-2722	04	
* 11-2723	05	\$404.73
11-2725	37	
* 11-2724	16	\$461.54
SL-Lock Body Assemblies - For interchangeable (70-) core cylinder functions		
Part No	Function	Price
11-2775	04	
* 11-2776	05	\$355.05
11-2781	37	
* 11-2779	24	
* 11-2783	44	\$383.41
* 11-2784	54	
11-2777	16	
11-2778	17	
11-2780	30	\$411.83
11-2782	38	
SL-Lock Body Assemblies - 41- Option - For interchangeable (70-) core cylinder functions		
Part No	Function	Price
11-2813	04	
* 11-2814	05	\$404.73
11-2816	37	
* 11-2815	16	\$461.54

Note: Lockbodies are shipped with bearing assembly, inside & outside sleeve, and inside & outside collar.

* Specify finish when ordering.

Experience a safer
and more open world

Copyright © 2002-2021 Sargent Manufacturing Company, an ASSA ABLOY Group company. All rights reserved.
Reproduction in whole or in part without the express written permission of Sargent Manufacturing Company is prohibited.
Contact us at: 800-727-5477 or visit www.sargentlock.com. In Canada contact us at: 800-461-3007 or visit www.assaabloydss.ca

SL-Lock Body Assemblies - For 82- KESO cylinder functions

Part No	Function	Price
11-2843	04	
* 11-2844	05	\$362.13
11-2849	37	
* 11-2847	24	
* 11-2851	44	\$390.54
* 11-2852	54	
11-2845	16	
11-2846	17	
11-2848	30	\$418.92
11-2850	38	

SL-Lock Body Assemblies - For 41- Option - For 82- KESO cylinder functions

Part No	Function	Price
11-2865	04	
* 11-2866	05	\$411.83
11-2868	37	
* 11-2867	16	\$468.64

Note: Lockbodies are shipped with bearing assembly, inside & outside sleeve, and inside & outside collar.

* Specify finish when ordering

BL-10 BORED LOCKS

SARGENT®

LEVERS & ROSES

ASSA ABLOY

USA & Canada Prices Effective May 1, 2021

Levers		Finish	
Part No.	Description (Inside or Outside)	03/04/09/10/10B/10BE/10BL/ 14/15/20D/26/26D/BSP/WSP	
11-0041	L lever, plain		
11-0043	L lever, std. cylinder, button and emergency release		
11-0044	L lever, 60- option SARGENT removable core		
11-0045	L lever, 70- option interchangeable core		
11-0046	L lever, 30- option to accept Schlage cyl		
11-0047	L lever, VC- option		
11-0048	L lever, 82- option to accept KESO		
11-0399	L lever, SF- option Schlage LFIC		
11-0441	L lever, YC- or YC-7P- option to accept Yale® 6- or 7-pin fixed core cylinder		
11-0443	L lever, YRC- option to accept Yale® 6-pin LFIC		
11-0445	L lever, YRC-7P- option to accept Yale® 7-pin LFIC		
11-0061	B lever, plain		
11-0063	B lever, std. cylinder, button and emergency release	\$89.00	
11-0064	B lever, 60- option SARGENT removable core		
11-0065	B lever, 70- option interchangeable core		
11-0066	B lever, 30- option to accept Schlage cyl		
11-0067	B lever, VC- option		
11-0068	B lever, 82- option to accept KESO		
11-0101	P lever, plain		
11-0103	P lever, std. cylinder, button and emergency release		
11-0104	P lever, 60- option SARGENT removable core		
11-0105	P lever, 70- option interchangeable core		
11-0106	P lever, 30- option to accept Schlage cyl		
11-0107	P lever, VC- option		
11-0108	P lever, 82- option to accept KESO		
11-0447	P lever, YC- or YC-7P- option to accept Yale® 6- or 7-pin fixed core cylinder		
11-0449	P lever, YRC- option to accept Yale® 6-pin LFIC		
11-0451	P lever, YRC-7P- option to accept Yale® 7-pin LFIC		
11-2558	J lever, plain		
11-2560	J lever, std. cylinder, button and emergency release		
11-2561	J lever, 60- option SARGENT removable core		
11-2562	J lever, 70- option interchangeable core	\$96.00	
11-2563	J lever, 30- option to accept Schlage cyl		
11-2564	J lever, VC- option		
11-2565	J lever, 82- option to accept KESO		
Note:	For handicapped levers, consult factory Standard Cylinder includes 10, 21, 22, SC, SE options		

Roses		Finish	
Part No.	Description	10BE/26D BSP/WSP	03/04/09/10/10B/ 10BL/14/15/20D/26
11-2444	O rose assy, inside or outside - all except O/S 15-3, 93, 94 and I/S 38 functions		
11-2482	O rose assy, outside - 15-3 function		
11-2887	O rose assy, inside - 38 function		
11-2448	O rose assy, inside or outside - 93, 94 functions	\$44.36	\$51.46
11-2445	B rose assy, inside or outside - all except O/S 15-3, 93, 94 functions		
11-2483	B rose assy, outside - 15-3 function		
11-2449	B rose assy, inside or outside - 93, 94 functions		
11-2447	E rose assy, inside or outside - all except O/S 15-3, 93, 94 and I/S 38 functions		
11-2484	E rose assy, outside - 15-3 function	\$47.92	\$54.98
11-2889	E rose assy, inside - 38 function		
11-2451	E rose assy, inside or outside - 93, 94 functions		
11-2446	L rose assy, inside or outside - all except O/S 15-3, 93, 94 and I/S 38 functions		
11-2450	L rose assy, inside or outside - 93, 94 functions	\$51.46	\$58.59
11-2485	L rose assy, outside - 15-3 function		
11-2888	L rose assy, inside - 38 function		

Experience a safer
and more open world

Copyright © 2002-2021 Sargent Manufacturing Company, an ASSA ABLOY Group company. All rights reserved.
Reproduction in whole or in part without the express written permission of Sargent Manufacturing Company is prohibited.
Contact us at: 800-727-5477 or visit www.sargentlock.com. In Canada contact us at: 800-461-3007 or visit www.assaabloydss.ca

USA & Canada Prices Effective May 1, 2021

SL-Levers		Finish
Part No.	Description (Inside or Outside)	03/04/09/10/10B/10BE/ 10BL/14/15/20D/26/26D/BSP/WSP
11-0301	SL-L lever, std. cylinder and emergency release (65)	
11-0302	SL-L lever, 60- option SARGENT removable core	
11-0303	SL-L lever, 70- option interchangeable core	
11-0304	SL-L lever, 30- option to accept Schlage cyl	
11-0305	SL-L lever, VC- option	
11-0306	SL-L lever, 82- option to accept KESO	
11-0401	SL- L Lever, SF- option Schlage LFIC	
11-0317	SL-B lever, std. cylinder and emergency release (65)	
11-0318	SL-B lever, 60- option SARGENT removable core	
11-0319	SL-B lever, 70- option interchangeable core	
11-0320	SL-B lever, 30- option to accept Schlage cyl	\$89.00
11-0321	SL-B lever, VC- option	
11-0322	SL-B lever, 82- option to accept KESO	
11-0349	SL-P lever, std. cylinder and emergency release (65)	
11-0350	SL-P lever, 60- option SARGENT removable core	
11-0351	SL-P lever, 70- option interchangeable core	
11-0352	SL-P lever, 30- option to accept Schlage cyl	
11-0353	SL-P lever, VC- option	
11-0354	SL-P lever, 82- option to accept KESO	
11-2869	SL-J lever, std. cylinder and emergency release (65)	
11-2870	SL-J lever, 60- option SARGENT removable core	
11-2871	SL-J lever, 70- option interchangeable core	\$96.00
11-2872	SL-J lever, 30- option to accept Schlage cyl	
11-2873	SL-J lever, VC- option	
11-2874	SL-J lever, 82- option to accept KESO	

Note: For handicapped levers, consult factory
Standard cylinder includes 10, 21, 22, SC, SE options

BL-12 BORED LOCKS

SLEEVE ASSEMBLIES

SARGENT®

ASSA ABLOY

USA & Canada Prices Effective May 1, 2021

Locking Sleeve Assemblies for standard cylinder functions, 10-, 21-, 22-, 30-, SC, SE-		Price
Part No	Description	
11-2009	Locking sleeve assy - 04, 05, 16, 44 function, outside	\$173.96
11-2010	Locking sleeve assy - 13 function, outside	\$92.31
11-2011	Locking sleeve assy - 16, 38 function, inside	\$230.78
11-2012	Locking sleeve assy - 17 function, outside	\$170.40
11-2013	Locking sleeve assy - 17 function, inside	\$166.85
11-2014	Locking sleeve assy - 30, 37 function, outside	\$170.40
11-2015	Locking sleeve assy - 30 function, inside	\$166.85
11-2016	Locking sleeve assy - 50 function, outside	\$173.96
11-2017	Locking sleeve assy - 38, 54 function, outside	\$195.25
11-2055	Locking sleeve assy - 65 function, outside	\$149.12
11-2909	Locking sleeve assy - 24 function, outside	\$173.96
11-2028	Locking sleeve assy, 41- option, 3/4" throw latch -4, 05, 16 function, outside	\$181.07
11-2029	Locking sleeve assy, 41- option, 3/4" throw latch -16 function, inside	\$230.78
11-2030	Locking sleeve assy, 41- option, 3/4" throw latch -37 function, outside	\$170.40

Note: for 41- option locking sleeves used with other cylinder options, consult factory for part number.

Locking Sleeve Assemblies for 63- (60-) option removable core & 73- (70-) option interchangeable core		Price
Part No	Description	
11-2031	Locking sleeve assy - 04, 05, 16, 44 function, outside	\$177.52
11-2032	Locking sleeve assy - 16, 38 function, inside	\$170.40
11-2033	Locking sleeve assy - 17 function, outside	\$170.40
11-2034	Locking sleeve assy - 17 function, inside	\$170.40
11-2035	Locking sleeve assy - 30, 37 function, outside	\$170.40
11-2036	Locking sleeve assy - 30 function, inside	\$163.30
11-2037	Locking sleeve assy - 38, 54 function, outside	\$191.72
11-2911	Locking sleeve assy - 24 function, outside	\$177.52

Note: for 63- or 73- option locking sleeve used with 31- or 41- options, consult factory for part number.

Locking Sleeve Assemblies for 82- option KESO		
Part No	Description	Price
11-2069	Locking sleeve assy - 04, 05, 16, 44 function, outside	\$177.52
11-2070	Locking sleeve assy - 16, 38 function, inside	\$170.40
11-2071	Locking sleeve assy - 17, outside	\$170.40
11-2072	Locking sleeve assy - 17, inside	\$170.40
11-2073	Locking sleeve assy - 30, 37, outside	\$170.40
11-2074	Locking sleeve assy - 30, inside	\$163.33
11-2075	Locking sleeve assy - 38, 54, outside	\$191.72
11-2915	Locking sleeve assy - 24 function, outside	\$177.52

Locking Sleeve Assemblies for VC- option interchangeable core		
Part No	Description	Price
11-2039	Locking sleeve assy - 04, 05, 16, 44 function, outside	\$173.96
11-2040	Locking sleeve assy - 16, 38 function, inside	\$127.81
11-2041	Locking sleeve assy - 17 function, outside	\$170.40
11-2042	Locking sleeve assy - 17 function, inside	\$170.40
11-2043	Locking sleeve assy - 30, 37 function, outside	\$170.40
11-2044	Locking sleeve assy - 30 function, inside	\$166.85
11-2045	Locking sleeve assy - 38, 54 function, outside	\$181.07
11-2913	Locking sleeve assy - 24 function, outside	\$173.96

Non-Locking Sleeve Assemblies (for standard cylinder functions, 10-, 21-, 22-, 30-, SC, SE-)		
Part No	Description	Price
11-2151	Non-locking sleeve assy - 04, 13 function, inside	\$81.65
* 11-2152	Non-locking sleeve assy - 05 function, inside	\$124.27
11-2153	Non-locking sleeve assy - 15, 15-3, 37 function, inside - 15 function, outside	\$81.65
* 11-2154	Non-locking sleeve assy - 44 function, inside	\$124.27
* 11-2155	Non-locking sleeve assy - 50 function, inside	\$134.93
* 11-2156	Non-locking sleeve assy - 54, 65 function, inside	\$124.27 *
11-2157	Non-locking sleeve assy - 24function, inside	\$173.96

11-2166	Non-locking sleeve assy, 41- option 3/4" throw latch -04 function, inside	\$81.65
* 11-2167	Non-locking sleeve assy, 41- option 3/4" throw latch -05 function, inside	\$124.27
11-2168	Non-locking sleeve assy, 41- option 3/4" throw latch -15, 15-3, 37 function, inside/15 function outside	\$85.21

*Specify finish when ordering

SL-Locking Sleeve Assemblies for standard cylinder functions, 10-, 21-, 22-, 30-, SC, SE-		
Part No	Description	Price
11-2597	SL-Locking sleeve assy - 04, 05, 16, 24, 44 function, outside	\$173.96
11-2598	SL-Locking sleeve assy - 16, 38 function, inside	\$230.78
11-2599	SL-Locking sleeve assy - 17 function, outside	\$170.40
11-2600	SL-Locking sleeve assy - 17 function, inside	\$166.85
11-2601	SL-Locking sleeve assy - 30, 37 function, outside	\$170.40
11-2602	SL-Locking sleeve assy - 30 function, inside	\$166.85
11-2603	SL-Locking sleeve assy - 50 function, outside	\$173.96
11-2604	SL-Locking sleeve assy - 38, 54 function, outside	\$195.25
11-2614	SL-Locking sleeve assy, 41- option, 3/4" throw latch -04, 05, 16 function, outside	\$181.07
11-2615	SL-Locking sleeve assy, 41- option, 3/4" throw latch -16 function, inside	\$230.78
11-2616	SL-Locking sleeve assy, 41- option, 3/4" throw latch -37 function, outside	\$170.40

Note: for 41- option locking sleeves used with other cylinder options, consult factory for part number.

SL-Locking Sleeve Assemblies for 63- or 73- option removable or interchangeable core		
Part No	Description	Price
11-2617	SL-Locking sleeve assy - 04, 05, 16, 24, 44 function, outside	\$177.52
11-2618	SL-Locking sleeve assy - 16, 38 function, inside	\$170.40
11-2619	SL-Locking sleeve assy - 17 function, outside	\$170.40
11-2620	SL-Locking sleeve assy - 17 function, inside	\$170.40
11-2621	SL-Locking sleeve assy - 30, 37 function, outside	\$170.40
11-2622	SL-Locking sleeve assy - 30 function, inside	\$163.33
11-2623	SL-Locking sleeve assy - 38, 54 function, outside	\$191.72

Note: for 63- or 73- option locking sleeve used with 31- or 41- options, consult factory for part number.

BL-14 BORED LOCKS

SARGENT®



SL-SLEEVE, LATCH, & BEARING ASSEMBLIES

ASSA ABLOY

USA & Canada Prices Effective May 1, 2021

SL-Locking Sleeve Assemblies for 82- option KESO		
Part No	Description	Price
11-2653	SL-Locking sleeve assy - 04, 05, 16, 24, 44 function, outside	\$177.52
11-2654	SL-Locking sleeve assy - 16, 38 function, inside	\$170.40
11-2655	SL-Locking sleeve assy - 17, outside	\$170.40
11-2656	SL-Locking sleeve assy - 17, inside	\$170.40
11-2657	SL-Locking sleeve assy - 30, 38, outside	\$170.40
11-2658	SL-Locking sleeve assy - 30, inside	\$163.33
11-2659	SL-Locking sleeve assy - 38, 54, outside	\$191.72
SL-Locking Sleeve Assemblies for VC- option interchangeable core		
Part No	Description	Price
11-2635	SL-Locking sleeve assy - 04, 05, 16, 24, 44 function, outside	\$173.96
11-2636	SL-Locking sleeve assy - 16, 38 function, inside	\$127.81
11-2637	SL-Locking sleeve assy - 17 function, outside	\$170.40
11-2638	SL-Locking sleeve assy - 17 function, inside	\$170.40
11-2639	SL-Locking sleeve assy - 30, 37 function, outside	\$170.40
11-2640	SL-Locking sleeve assy - 30 function, inside	\$166.85
11-2641	SL-Locking sleeve assy - 38, 54 function, outside	\$181.07
Latch Assemblies (specify finish when ordering)		Finish 03/04/09/10/10B/10BE/10BL/20D/32/32D/BSP/WSP
Part #	Description	Price
11-2106	2-3/4" BS, Guarded latch assy 04, 05, 13, 15-3, 16, 17, 30, 37, 38 function	\$142.01
11-2108	2-3/4" BS, Guarded latch assy 24 function	\$142.01
11-2110	2-3/4" BS, Guarded latch assy 44, 50, 54 function	\$142.01
11-2107	2-3/4" BS, Unguarded latch assy 15 function	\$142.01
11-2111	2-3/4" BS, Unguarded latch assy 65, 68 function	\$142.01
11-2112	2-3/4" BS, Unguarded latch assy 94-2 function	\$142.01
11-2113	23- Option, 3-3/4" BS, Guarded latch assy 04, 05, 13, 15-3, 16, 17, 30, 37, 38 function	\$158.17
11-2115	23- Option, 3-3/4" BS, Guarded latch assy 24 function	\$158.17
11-2117	23- Option, 3-3/4" BS, Guarded latch assy 44, 50, 54 function	\$158.17
11-2114	23- Option, 3-3/4" BS, Unguarded latch assy 15 function	\$158.17
11-2118	23- Option, 3-3/4" BS, Unguarded latch assy 65, 68 function	\$158.17
11-2119	23- Option, 3-3/4" BS, Unguarded latch assy 94-2 function	\$158.17
11-2120	25- Option, 5" BS, Guarded latch assy 04, 05, 13, 15-3, 16, 17, 30, 37, 38 function	\$166.21
11-2122	25- Option, 5" BS, Guarded latch assy 24 function	\$166.21
11-2124	25- Option, 5" BS, Guarded latch assy 44, 50, 54 function	\$166.21
11-2121	25- Option, 5" BS, Unguarded latch assy 15 function	\$166.21
11-2125	25- Option, 5" BS, Unguarded latch assy 65, 68 function	\$166.21
11-2126	25- Option, 5" BS, Unguarded latch assy 94-2 function	\$166.21
08-2517	41- Option, 3/4" throw, 2-3/4" BS, Guarded latch assy 04, 05, 15, 15-3, 16, 37, 38 function	\$219.82
Bearing Assemblies		Price
11-2899	Bearing assy 04, 05, 13, 15, 15-3, 16, 17, 24, 30, 37, 38, 44, 50, 54, 65, 68 function	\$177.52
11-2004	Bearing assy, 31- option, 04, 05, 13, 15, 15-3, 16, 17, 24, 30, 37, 38, 44, 50, 54, 65, 68 function	\$223.66
11-2005	Bearing assy, 41- option, 3/4" throw latch 04, 05, 15, 15-3, 16, 37, 38, 68 function	\$198.82

Experience a safer
and more open world

Copyright © 2002-2021 Sargent Manufacturing Company, an ASSA ABLOY Group company. All rights reserved.
Reproduction in whole or in part without the express written permission of Sargent Manufacturing Company is prohibited.
Contact us at: 800-727-5477 or visit www.sargentlock.com. In Canada contact us at: 800-461-3007 or visit www.assaabloydss.ca

Miscellaneous Parts *specify finish when ordering		Price
* 01-0225	Cup Washer	\$4.08
* 01-1018	Countersunk Flat head Screw 10-24 x 1/2" (2" Dr)	\$1.07
01-1027	Countersunk Flat head Screw 10-24 x 3/8" (1-3/4" Dr)	\$0.95
* 01-1316	Spanner set screw - for lever only (bit size #6)	\$3.96
01-1424	6-Lobe security set screw for lever only 1/4-28 x .1675" (bit size T-20)	\$5.86
01-2201	Wood Screw #4 x 1/2"	\$0.89
01-3337	Machine Screw #4-40 x 1/2"	\$4.76
* 01-4373	Countersunk Flat Head Screw 1/4-20 x 2-3/4"	\$5.63
01-4530	6-Lobe Security Tool (Torx™) – to assemble lever set screw	\$12.33
* 01-5000	Countersunk Flat Head Screw 8-32 x 3/4"	\$0.89
* 01-5001	Subfront Screws (6010 kit)	\$1.23
01-9109	Machine Screw #6-32 x 3/8"	\$0.88
* 08-0562	Subfront (6010 kit)	\$70.55
11-0031	Collar inside	\$7.12
11-0032	Collar outside	\$10.34
11-0394	Aligning pin - standard	\$16.11
11-0396	Aligning pin (2-1/4" DOOR)	\$16.11
11-0397	Aligning pin (2-1/2" DOOR)	\$16.11
11-0138	Installation wrench – to assemble rose & collars	\$9.38
11-0171	Cylinder tailpiece - interchangeable core - 6 pin	\$1.83
11-0172	Cylinder tailpiece - interchangeable core - 7 pin and 6 pin Sargent removable core	\$1.83
11-0174	Anchor Plate	\$0.82
11-0263	Threaded Plunger	\$19.36
11-0266	Screwdriver	\$6.59
11-0276	Cylinder Tailpiece Pack for 11-IC Cores	\$6.59
11-0403	Tailpiece (11 Line) for Schlage SF prefix	\$4.97
* 11-2263	Thumbturn – 68 function	\$47.48
11-2495	Mounting Flange Assy. (93 & 94 function)	\$129.11
11-2496	Mounting Flange Assy. (94 function)	\$129.11
11-2501	Tube Assy. (94-2 function)	\$242.06
11-2520	Screw pack	\$19.51
* 11-2521	93 & 94 function screw pack	\$24.86
11-2522	36- Screw pack	\$46.17
* 11-2523	36- 93 & 94 function screw pack	\$81.66
11-2524	37- Screw pack	\$46.17
* 11-2525	37- 93 & 94 function screw pack	\$81.66
11-2526	28- screw pack	\$19.51
11-2527	28-36- screw pack	\$46.17
11-2528	28-37- screw pack	\$46.17
11-2529	41- screw pack	\$19.51
11-2530	41-36 screw pack	\$46.17
11-2531	41-37 screw pack	\$46.17
11-2578	Tailpiece pack for 30- option cylinder	\$7.87
11-5003	11 Line "T-Zone" Tail Piece & Retainer Pack	\$9.10
11-5004	Cylinder spacer for 6-Pin fixed core Yale® cylinder	\$10.41
11-5005	Cylinder tailpiece pack for Yale® 6 or 7-pin LFIC	\$2.26
13-1385	Cylinder tailpiece – adapts 10L cylinder to 11L cylinder - standard cylinder	\$2.28
14-0057	Emergency key privacy function only	\$1.86
14-0299	Lockout key – 50 function	\$5.48
* C11-3	Emergency Release Cyl. (65 function)	\$58.66

BL-16 BORED LOCKS

SARGENT®

ASSA ABLOY

10X-LINE OPTIONS

USA & Canada Prices Effective May 1, 2021

Options	Description	Price
1	Adapter plates for 1-3/8" thick door	\$28.00
10▲	SARGENT Signature Key System	\$63.00 / cyl.
11▲	SARGENT XC Key System (not available with 10, 22, SC, SE options)	No addition
1160▲	Sargent XC Large Format Interchangeable Plastic Disposable Construction Core	No addition
1163▲	Sargent XC Large Format Interchangeable Core Cylinder - Includes masterkeying charges	\$83.00
1164▲	Sargent XC Large Format Interchangeable Construction Core Cylinder	\$83.00
1170	Small Format interchangeable disposable construction core - to accept 7 Pin XC permanent core	No addition
11727P	Small Format interchangeable keyed construction core - to accept 7 Pin XC permanent core	\$75.00
11737P	Small Format interchangeable core - to accept 7 pin XC permanent core	\$75.00 /cyl.
20	2-3/8" backset with 1" front	No addition
21▲	SARGENT Construction Key System (lost ball) Standard on new systems est. since 5/1/96	\$16.00 / cyl.
22▲	SARGENT Construction Key System (split key) For pre-established key systems only	\$32.00 / cyl.
23	Lockset x 3-3/4" Backset	\$10.00
25	Lockset x 5" Backset	\$15.00
29	Lockset x T-Strike - 1-1/4" Lip Lip Lengths 1" Lip lengths 1-1/2", 1-3/4", 2"	No addition \$11.00
30▲	Lever to accept Schlage cylinder - no cylinder provided	No addition
31	For 2" to 2-1/4" thick doors, centered in door prep, no paneling. Consult factory for other door thicknesses available by special application.	No addition
36	6 Lobe security head screws	\$15.00
37	Spanner head screws	\$10.00
41	3/4" Throw with latch	\$106.00
60▲	SARGENT Large Format Interchangeable Plastic Disposable Construction Core	No addition
63▲	SARGENT Large Format IC Core Cylinder includes master and grandmaster keying charge	\$83.00 / cyl
64▲	SARGENT Large Format Interchangeable Construction Core Cylinder	\$83.00
6573▲	Small Format 6 Pin Uncombined Core	\$65.00 / cyl.
65737P▲	Small Format 7 Pin Uncombined Core	\$65.00 / cyl.
70▲	Small Format Interchangeable disposable plastic construction core	No addition
72▲	Small Format Interchangeable 6-pin Construction Core (7-Pin w/11-Option)	\$75.00
73▲	Small Format Interchangeable Core, 6-Pin Includes MK and GMK keying charges	\$75.00 / cyl.
737P▲	Small Format Interchangeable Core, 7-Pin Includes MK and GMK keying charges	\$75.00 / cyl.
74	Lead Lining I/S Rose, O/S Rose, and Latch Tube	\$214.00 /lock
75	Tactile Warning - Milled on backside of inside lever (L, B, P levers only)	\$40.00
76	Tactile Warning - Milled on backside of outside lever (L, B, P levers only)	\$40.00
77	Tactile Warning - Milled on backside of both levers (L, B, P levers only)	\$80.00
80▲	Levers to accept KESO and Keso F1 cylinders – no cylinders provided (L, B, P levers only)	-\$94.00/cyl.
F182▲	SARGENT KESO Security Cylinder – patented – new key systems (L, B, P levers only)	\$91.00 /cyl.
82▲	SARGENT KESO Security Cylinder (L,B,P levers only)	\$91.00 / cyl.
85	Tactile Warning - Abrasive coating finish on inside lever	\$49.00
86	Tactile Warning - Abrasive coating finish on outside lever	\$49.00
87	Tactile Warning - Abrasive coating finish on both levers	\$98.00
BR	SARGENT Bump Resistant Cyls. (N/A w/10, 22, 30, 60, 63, 64, 70, 72, 73, 737P, KESO, SC, SE)	\$25.00 /cyl.
DG1	Patented Degree DG1 Key System	No addition
DG160	Hardware prepared for DG1-6300 Lg. Format IC cores, supplied with temporary plastic construction cores	No addition
DG163	Patented Degree DG1 Large Format Interchangeable Core Cylinder - Includes master keying charges	\$83.00
DG164	Hardware prepared for DG1-6300 Lg. Format IC cores, supplied with temporary keyed construction cores	\$83.00
DG2	Patented Degree DG2 Key System incorporating a locking sidebar	\$63.00/cyl.
DG260	Hardware prepared for DG2-6300 Lg. Format IC cores, supplied with temporary plastic construction cores	No addition
DG263	Patented Degree DG2 Large Format Interchangeable Core Cylinder - Includes master keying charges	\$146.00
DG264	Hardware prepared for DG2-6300 Lg. Format IC cores, supplied with temporary keyed construction cores	\$83.00
DG3	Patented Degree DG3 Key System incorporating a locking sidebar and UL437 listed	\$89.00/cyl.
DG360	Hardware prepared for DG3-6300 Lg. Format IC cores, supplied with temporary plastic construction cores	No addition
DG363	Patented Degree DG3 Large Format Interchangeable Core Cylinder - Includes master keying charges	\$172.00
DG364	Hardware prepared for DG3-6300 Lg. Format IC cores, supplied with temporary keyed construction cores	\$83.00
FW	Freewheeling Locking Levers	\$0.00
RX	Request to Exit (available with 04, 05, 37, 15, 70-12V & 24V, and 71-12V & 24V) functions Handing required when ordering – How to order: RX-10XG05 x LL x 26D x RH	\$206.00
LC	Less Cylinder	-\$94.00/cyl.
SC▲	Schlage C Keyway cylinder, 0 bitted	No addition
SE▲	Schlage E Keyway cylinder, 0 bitted	No addition
SF	L, B, or P Lever to accept Schlage Large Format Interchangeable Core (supplied less core, tailpiece included)	No Addition
SG	MicroShield® – an antimicrobial powder coat	\$73.00
CPC	Clear Powder Coat over 26D – 10XG05 x GL x 26D x CPC	\$67.00
WBS	Wrought Box Strike	No Addition
YC	Lever to accept Yale® 6-pin fixed core cylinder (all designs, supplied less cylinder, tailpiece included)	No addition
YC7P	Lever to accept Yale® 7-pin fixed core cylinder (all designs, supplied less cylinder, tailpiece included)	No addition
YRC	L or P Lever to accept Yale® 6-pin LFIC (supplied less core, tailpiece included)	No addition

▲ Options NOT available with 50 function.

Experience a safer
and more open world

Copyright © 2002-2021 Sargent Manufacturing Company, an ASSA ABLOY Group company. All rights reserved.
Reproduction in whole or in part without the express written permission of Sargent Manufacturing Company is prohibited.
Contact us at: 800-727-5477 or visit www.sargentlock.com. In Canada contact us at: 800-461-3007 or visit www.assaabloydss.ca

USA & Canada Prices Effective May 1, 2021

Rose Design: G, L	Lever Design: L, B, P, MB, MD, MW, ND							
L Rose / L Lever	L Rose / B Lever	L Rose / P Lever	L Rose / MB Lever	L Rose / MD Lever	L Rose / MW Lever	L Rose / ND Lever		

*Contact customer service for availability.

Function		Finish	
Single Cylinder		10BE/26D/BSP/WSP	03/04/09/10/10B/10BL/14/15/20D/26
10XG04	Storeroom/Closet		
10XG05	Entry/Office		
10XG07	Communicating Storeroom	\$704.00	\$720.00
10XG08	Communicating Classroom		
10XG37	Classroom		
10XG60	Storeroom or Public Restroom		
10XG24	Entry	\$719.00	\$735.00
10XG44	Service Station		
10XG50	Hotel		
10XG53	Corridor, Dormitory	\$781.00	\$797.00
10XG54	Corridor, Dormitory		
Double Cylinder			
10XG16	Classroom Security/Public Entrance		
10XG17	Utility/Asylum/Institutional		
10XG26	Storeroom	\$809.00	\$825.00
10XG30	Communicating		
10XG38	Classroom security		
Non Keyed			
10XU15	Passage	\$505.00	\$521.00
10XG13	Exit		
10XG14	Patio or Privacy		
10XG15-3	Exit		
10XG64	Time Out Lock	\$601.00	\$617.00
10XU65	Privacy		
10XU68	Hospital Privacy		
10XU93	1/2 Dummy Trim	\$218.00	\$226.00
10XU94	Dummy Trim	\$438.00	\$454.00
10XU94-2	Dummy Trim	\$443.00	\$459.00
Strikes		Specify Finish	
800	ANSI A115.2 T Strike Curved Lip (29 Option) Furnished with Lip Length 1-1/4" standard		\$27.00
	Lip Lengths 1"		\$37.00
	Lip Lengths 1-1/2", 1-3/4", 2"		\$49.00
808	ANSI A115.2 Strike Curved Lip With 1-1/4" Lip C to E Standard		\$37.00
	Lip Lengths 1-1/8", 1-3/8"		\$49.00
	Lip Lengths 1-5/8", 1-7/8", 2-1/8", 2-3/8", 2-5/8", 2-7/8"		\$57.00
AM-0044	Strike Box (Used with 800 strike)		\$12.00
77-1141	Strike Box (Used with 808 strike)		\$12.00

Note: Split finishes are available, price as higher finish. Order outside/inside and handing must be specified. Strike and latch front will match inside finish for RH/LH and outside finish for RHR/LHR.

BL-18 BORED LOCKS

SARGENT®

10X-LINE LEVERS

ASSA ABLOY

USA & Canada Prices Effective May 1, 2021

Lever Handles 1-3/8" to 2-1/4" Doors		Finish	
Part #	Description (Inside or Outside)	03/04/09/10/10B/10BE/10BL/14/15/20D/26/26D/BSP/WSP	Price
10-1121	"B" - Passage/plain		
10-1120	"B" - Push/turn button, T-turn (68), emergency release (65), fixed core cylinder (SARGENT® 6-pin)		
10-1122	"B" - Fixed core cylinder (Corbin Russwin 6/7-pin, Schlage® 6-pin, Yale® 6/7-pin)		
10-1123	"B" - LFIC (SARGENT® 60-, 63-, 64-)		
10-1125	"B" - LFIC (Schlage® 6-pin SF-)		
10-1124	"B" - SFIC 6/7-pin (70-, 72-, 73-)		
10-1126	"B" - KESO cylinder (SARGENT® 82-)		
10-1128	"L" - Passage/plain		
10-1127	"L" - Push/turn button, T-turn (68), emergency release (65), fixed core cylinder (SARGENT® 6-pin)		
10-1129	"L" - Fixed core cylinder (Corbin Russwin 6/7-pin, Schlage® 6-pin, Yale® 6/7-pin)		
10-1130	"L" - LFIC (SARGENT® 60-, 63-, 64-)		
10-1132	"L" - LFIC (Schlage® 6-pin SF-)		\$79.00
10-1134	"L" - LFIC (Yale® 6-pin YRC-)		
10-1131	"L" - SFIC 6/7-pin (70-, 72-, 73-)		
10-1133	"L" - KESO cylinder (SARGENT® 82-)		
10-1137	"P" - Passage/plain		
10-1136	"P" - Push/turn button, T-turn (68), emergency release (65), fixed core cylinder (SARGENT® 6-pin)		
10-1138	"P" - Fixed core cylinder (Corbin Russwin 6/7-pin, Schlage® 6-pin, Yale® 6/7-pin)		
10-1139	"P" - LFIC (SARGENT® 60-, 63-, 64-)		
10-1141	"P" - LFIC (Schlage® 6-pin SF-)		
10-1143	"P" - LFIC (Yale® 6-pin YRC-)		
10-1140	"P" - SFIC 6/7-pin (70-, 72-, 73-)		
10-1142	"P" - KESO cylinder (SARGENT® 82-)		
10-1263	"MB" - Passage/plain		
10-1264	"MB" - Push/turn button, T-turn (68), emergency release (65), fixed core cylinder (SARGENT® 6-pin)		
10-1265	"MB" - Fixed core cylinder (Corbin Russwin 6/7-pin, Schlage® 6-pin, Yale® 6/7-pin)		
10-1266	"MB" - LFIC (SARGENT® 60-, 63-, 64-)		
10-1267	"MB" - SFIC 6/7-pin (70-, 72-, 73-)		
10-1240	"MD" - Passage/plain		
10-1241	"MD" - Push/turn button, T-turn (68), emergency release (65), fixed core cylinder (SARGENT® 6-pin)		
10-1242	"MD" - Fixed core cylinder (Corbin Russwin 6/7-pin, Schlage® 6-pin, Yale® 6/7-pin)		
10-1243	"MD" - LFIC (SARGENT® 60-, 63-, 64-)		
10-1244	"MD" - SFIC 6/7-pin (70-, 72-, 73-)		
10-1268	"MW" - Passage/plain		\$79.00
10-1269	"MW" - Push/turn button, T-turn (68), emergency release (65), fixed core cylinder (SARGENT® 6-pin)		
10-1270	"MW" - Fixed core cylinder (Corbin Russwin 6/7-pin, Schlage® 6-pin, Yale® 6/7-pin)		
10-1271	"MW" - LFIC (SARGENT® 60-, 63-, 64-)		
10-1272	"MW" - SFIC 6/7-pin (70-, 72-, 73-)		
10-1245	"ND" - Passage/plain		
10-1246	"ND" - Push/turn button, T-turn (68), emergency release (65), fixed core cylinder (SARGENT® 6-pin)		
10-1247	"ND" - Fixed core cylinder (Corbin Russwin 6/7-pin, Schlage® 6-pin, Yale® 6/7-pin)		
10-1248	"ND" - LFIC (SARGENT® 60-, 63-, 64-)		
10-1249	"ND" - SFIC 6/7-pin (70-, 72-, 73-)		
Lever Handles 1-3/8" to 2-1/4" Doors with Milling (75-, 76-, 77-)			
10-1146	"B" - Passage/plain		
10-1145	"B" - Push/turn button, T-turn (68), emergency release (65), fixed core cylinder (SARGENT® 6-pin)		
10-1147	"B" - Fixed core cylinder (Corbin Russwin 6/7-pin, Schlage® 6-pin, Yale® 6/7-pin)		
10-1148	"B" - LFIC (SARGENT® 60-, 63-, 64-)		
10-1150	"B" - LFIC (Schlage® 6-pin SF-)		
10-1149	"B" - SFIC 6/7-pin (70-, 72-, 73-)		
10-1151	"B" - KESO cylinder (SARGENT® 82-)		
10-1153	"L" - Passage/plain		
10-1152	"L" - Push/turn button, T-turn (68), emergency release (65), fixed core cylinder (SARGENT® 6-pin)		
10-1154	"L" - Fixed core cylinder (Corbin Russwin 6/7-pin, Schlage® 6-pin, Yale® 6/7-pin)		
10-1155	"L" - LFIC (SARGENT® 60-, 63-, 64-)		
10-1157	"L" - LFIC (Schlage® 6-pin SF-)		\$120.00
10-1159	"L" - LFIC (Yale® 6-pin YRC-)		
10-1156	"L" - SFIC 6/7-pin (70-, 72-, 73-)		
10-1158	"L" - KESO cylinder (SARGENT® 82-)		
10-1162	"P" - Passage/plain		
10-1161	"P" - Push/turn button, T-turn (68), emergency release (65), fixed core cylinder (SARGENT® 6-pin)		
10-1163	"P" - Fixed core cylinder (Corbin Russwin 6/7-pin, Schlage® 6-pin, Yale® 6/7-pin)		
10-1164	"P" - LFIC (SARGENT® 60-, 63-, 64-)		
10-1166	"P" - LFIC (Schlage® 6-pin SF-)		
10-1168	"P" - LFIC (Yale® 6-pin YRC-)		
10-1165	"P" - SFIC 6/7-pin (70-, 72-, 73-)		
10-1167	"P" - KESO cylinder (SARGENT® 82-)		

Experience a safer
and more open world

Copyright © 2002-2021 Sargent Manufacturing Company, an ASSA ABLOY Group company. All rights reserved.
Reproduction in whole or in part without the express written permission of Sargent Manufacturing Company is prohibited.
Contact us at: 800-727-5477 or visit www.sargentlock.com. In Canada contact us at: 800-461-3007 or visit www.assaabloydss.ca

USA & Canada Prices Effective May 1, 2021

Roses		10BE/26D/BSP/WSP	03/04/09/10/10B/10BL/14/15/20D/26
10-0790*	G Rose/Scalp, All Functions	\$65.76	\$89.56
10-0804*	G Rose/Scalp Inside 38 Function	\$65.76	\$89.56
10-0798*	L Rose/Scalp, All Functions	\$47.51	\$71.24
10-0805*	L Rose/Scalp, Inside 38 Function	\$47.51	\$71.24
10-1260*	Blank Rose/Plate, 07, 08, 15-3 Functions	\$68.06	\$92.69
Latch Units			
Standard 2-3/4" Backset		03/04/09/10/10B/10BE/10BL/20D/32/32D/BSP/WSP	
10-3192	Guarded Latch		\$63.11
10-2022	Unguarded Latch		\$59.82
20 Option 2-3/8" Backset		03/04/09/10/10B/10BE/10BL/20D/32/32D/BSP/WSP	
10-3186	Guarded Latch 2-3/8"		\$76.04
10-2022	Unguarded Latch 2-3/8"		\$71.44
23 Option 3-3/4" Backset		03/04/09/10/10B/10BE/10BL/20D/32/32D/BSP/WSP	
10-2053	Guarded Latch		\$91.12
10-2054	Unguarded Latch		\$88.34
25 Option 5" Backset		03/04/09/10/10B/10BE/10BL/20D/32/32D/BSP/WSP	
10-2058	Guarded Latch		\$105.15
10-2057	Unguarded Latch		\$102.36
41 Option 2-3/4" Backset with 3/4" Throw		04/26D	
10-2634	Guarded Latch		\$139.54
Extension Only			
10-2059	3-3/4" Extension (add to 2-3/4" BS Latchbolt) 23- option		\$56.10
10-2060	5" Extension (add to 2-3/4" BS Latchbolt) 25- option		\$56.10
10-0048	Extension Cover Sleeve (Plastic)		\$4.77
Lock Body Assembly, Rigid Lever – All Cylinder/Core Preps (includes mounting plate)			
Part #	Function	Specify Finish	
10-3586	04, 13		
10-3588*	05		
10-3590	07		
10-3592	08		
10-3594*	24		
10-3596	15		
10-3597	15-3		
10-3598	16		
10-3600	17		
10-3602	26		\$295.98
10-3604	30		
10-3606	37, 38		
10-3608*	44		
10-3610*	50		
10-3612*	53		
10-3614*	54		
10-3616*	64		
10-3618*	14, 65, 68		
10-3620	60		

* Button included, finish must be specified.

BL-20 BORED LOCKS

SARGENT®

10X-LINE FW LOCKBODY ASSEMBLIES

ASSA ABLOY

USA & Canada Prices Effective May 1, 2021

Lock Body Assembly, Freewheeling Lever – All Cylinder/Core Preps (includes mounting plate)

Part #	Function	Specify Finish
10-3587	04, 13	
10-3589*	05	
10-3591	07	
10-3593	08	
10-3595*	24	
10-3599	16	
10-3601	17	
10-3603	26	
10-3605	30	\$295.98
10-3607	37,38	
10-3609*	44	
10-3611*	50	
10-3613*	53	
10-3615*	54	
10-3617*	64	
10-3619*	14, 65, 68	
10-3621	60	

* Button included, finish must be specified.

Outside Spring Housing Assemblies

Part Number	Description	List Price
10-3656	Functions 15-3, 07, 08	\$86.38
10-3571	All Functions except 07, 08, 15-3, 93, 94	\$86.38
10-3579	All Functions for Keso Cylinders	\$86.38
10-3584	All Functions for Yale® LFIC	\$86.38

Inside Spring Housing Assemblies

Part Number	Description	List Price
10-3572	Functions: 04, 05, 13,14,15,15-3, 24, 37, 44, 50, 53, 54, 60, 64, 65, 68	\$85.14
10-3622	Functions: 16, 17, 26, 30, 38	\$85.14
10-3580	All Functions for Keso Cylinders	\$85.14
10-3585	All Functions for Yale® LFIC	\$85.14

Dummy Spring Housing Assemblies

Part Number	Description	List Price
10-3573	Outside 93, 94, 94-2	\$21.24
10-3574	Inside 94, 94-2	\$21.24

Mounting Plate

Part Number	Description	List Price
10-1071	Outside Support/Mounting Plate 1-3/8" - 2-1/4" Door	\$63.43

Experience a safer
and more open world

Copyright © 2002-2021 Sargent Manufacturing Company, an ASSA ABLOY Group company. All rights reserved.
Reproduction in whole or in part without the express written permission of Sargent Manufacturing Company is prohibited.
Contact us at: 800-727-5477 or visit www.sargentlock.com. In Canada contact us at: 800-461-3007 or visit www.assaabloydss.ca

Cylinder & Miscellaneous Parts		
Part Number	Description	List Price
C10X-3	Emergency release cylinder (65 Function)	\$58.37
08-0660*	Dummy/blank front (94-2)	\$21.34
10-0042	Lockout key (50 Function)	\$3.82
10-0043	Push pin tool	\$0.58
10-1111	Spacer only - fixed core cylinder	\$2.60
10-1112	Spacer only - Keso	\$2.51
10-1115	Spacer only - LFIC/SFIC	\$2.51
10-1191	Yale® LFIC tailpiece pack, 6-pin, 1-3/8"- 2" door	\$9.99
10-1192	Yale® LFIC tailpiece pack, 6-pin, 2-1/4" door	\$9.99
10-1252	Hotel adjustment tool	\$12.00
10-3188	1-3/8" Door adapter plate pack (1- option)	\$47.94
10-3625	Schlage® fixed core tailpiece pack, 6-pin, 1-3/8"- 2" door	\$9.99
10-3626	Schlage® fixed core tailpiece pack, 6-pin, 2-1/4" door	\$9.99
10-3627	Schlage® LFIC tailpiece pack, 6-pin, 1-3/8"- 2" door	\$9.99
10-3628	Schlage® LFIC tailpiece pack, 6-pin, 2-1/4" door	\$9.99
10-3629	SARGENT fixed core cylinder tailpiece pack, 6-pin, 1-3/8"- 2" door	\$9.99
10-3630	SARGENT fixed core cylinder tailpiece pack, 6-pin, 2-1/4" door	\$9.99
10-3631	SARGENT LFIC tailpiece pack, 6-pin, 1-3/8"- 2" door	\$9.99
10-3632	SARGENT LFIC tailpiece pack, 6-pin, 2-1/4" door	\$9.99
10-3633	SFIC tailpiece pack, 6-or 7-pin, 1-3/8" - 2" door	\$9.99
10-3634	SFIC tailpiece pack, 6-or 7-pin, 2-1/4" door	\$9.99
10-3635	XC (11-) LFIC tailpiece pack, 6-pin, 1-3/8"- 2" door	\$9.99
10-3636	XC (11-) LFIC tailpiece pack, 6-pin, 2-1/4" door	\$9.99
10-3637	Keso cylinder tailpiece pack, 1-3/8" - 2" door	\$9.99
10-3638	Keso cylinder tailpiece pack, 2-1/4" door	\$9.99
10-3639	Yale® fixed core tailpiece pack, 6- or 7-pin, 1-3/8"- 2" door	\$9.99
10-3640	Yale® fixed core tailpiece pack, 6- or 7-pin, 2-1/4" door	\$9.99
10-3641	XC (11-) SFIC tailpiece pack, 6-or 7-pin, 1-3/8" - 2" door	\$9.99
10-3642	XC (11-) SFIC tailpiece pack, 6-or 7-pin, 2-1/4" door	\$9.99

* Specify Finish

10-LINE OPTIONS



USA & Canada Prices Effective May 1, 2021

Options	Description	Price
1	Adapter plates for 1-3/8" thick door	\$28.00
10▲	SARGENT Signature Key System	\$63.00 / cyl.
11▲	SARGENT XC Key System (not available with 10, 22, SC, SE options)	No addition
1160▲	Sargent XC Large Format Interchangeable Plastic Disposable Construction Core	No addition
1163▲	Sargent XC Large Format Interchangeable Core Cylinder - Includes masterkeying charges	\$83.00
1164▲	Sargent XC Large Format Interchangeable Construction Core Cylinder	\$83.00
1170	Small Format interchangeable disposable construction core - to accept 7 Pin XC permanent core	No addition
11727P	Small Format interchangeable keyed construction core - to accept 7 Pin XC permanent core	\$75.00
11737P	Small Format interchangeable core - to accept 7 pin XC permanent core	\$75.00 / cyl.
20	2-3/8" backset with 1" front	No addition
21▲	SARGENT Construction Key System (lost ball) Standard on new systems est. since 5/1/96	\$16.00 / cyl.
22▲	SARGENT Construction Key System (split key) For pre-established key systems only	\$32.00 / cyl.
23	Lockset x 3 - 3/4" Backset	\$10.00
25	Lockset x 5" Backset	\$15.00
28	Lockset x ANSI A-156.115 Strike – 1-1/4" Lip Standard	
	Lip Lengths 1-1/8" or 1-3/8"	No addition
	Lip Lengths 1-5/8", 1-7/8", 2-1/8", 2-3/8", 2-5/8", 2-7/8"	\$11.00
30▲	Lever to accept Schlage cylinder - no cylinder provided	No addition
36	6 Lobe security head screws	\$15.00
37	Spanner head screws	\$10.00
41	3/4" Throw with latch	\$106.00
60▲	SARGENT Large Format Interchangeable Plastic Disposable Construction Core	No addition
63▲	SARGENT Large Format IC Core Cylinder includes master and grandmaster keying charge	\$83.00 / cyl
64▲	SARGENT Large Format Interchangeable Construction Core Cylinder	\$83.00
6573▲	Small Format 6 Pin Uncombined Core	\$65.00 / cyl.
65737P▲	Small Format 7 Pin Uncombined Core	\$65.00 / cyl.
70▲	Small Format Interchangeable disposable plastic construction core	No addition
72▲	Small Format interchangeable 6-pin Construction Core (7-Pin w/11-Option)	\$75.00
73▲	Small Format Interchangeable Core, 6-Pin Includes MK and GMK keying charges	\$75.00 / cyl.
737P▲	Small Format Interchangeable Core, 7-Pin Includes MK and GMK keying charges	\$75.00 / cyl.
74	Lead Lining I/S Rose, O/S Rose, and Latch Tube	\$214.00 /lock
75	Tactile Warning - Milled on backside of inside lever	\$40.00
76	Tactile Warning - Milled on backside of outside lever	\$40.00
77	Tactile Warning - Milled on backside of both levers	\$80.00
80▲	Levers to accept KESO and Keso F1 cylinders – no cylinders provided	-\$94.00/cyl.
F182▲	SARGENT KESO Security Cylinder – patented – new key systems	\$91.00 /cyl.
82▲	SARGENT KESO Security Cylinder (L,B,P levers only)	\$91.00 / cyl.
85	Tactile Warning - Abrasive coating on inside lever	\$49.00
86	Tactile Warning - Abrasive coating on outside lever	\$49.00
87	Tactile Warning - Abrasive coating on both levers	\$98.00
BR	SARGENT Bump Resistant Cyls. (N/A w/10, 22, 30, 60, 63, 64, 70, 72, 73, 737P, KESO, SC, SE)	\$25.00 /cyl.
DG1	Patented Degree DG1 Key System	No addition
DG160	Hardware prepared for DG1-6300 Lg. Format IC cores, supplied with temporary plastic construction cores	No addition
DG163	Patented Degree DG1 Large Format Interchangeable Core Cylinder - Includes master keying charges	\$83.00
DG164	Hardware prepared for DG1-6300 Lg. Format IC cores, supplied with temporary keyed construction cores	\$83.00
DG2	Patented Degree DG2 Key System incorporating a locking sidebar	\$63.00/cyl.
DG260	Hardware prepared for DG2-6300 Lg. Format IC cores, supplied with temporary plastic construction cores	No addition
DG263	Patented Degree DG2 Large Format Interchangeable Core Cylinder - Includes master keying charges	\$146.00
DG264	Hardware prepared for DG2-6300 Lg. Format IC cores, supplied with temporary keyed construction cores	\$83.00
DG3	Patented Degree DG3 Key System incorporating a locking sidebar and UL437 listed	\$89.00/cyl.
DG360	Hardware prepared for DG3-6300 Lg. Format IC cores, supplied with temporary plastic construction cores	No addition
DG363	Patented Degree DG3 Large Format Interchangeable Core Cylinder - Includes master keying charges	\$172.00
DG364	Hardware prepared for DG3-6300 Lg. Format IC cores, supplied with temporary keyed construction cores	\$83.00
FW	Freewheeling Locking Levers L, B, P levers only, not available w/10G70, 10G71 functions	\$0.00
RX	Request to Exit (available with 04, 05, 37, 15, 70-12v & 24v, and 71-12v & 24v) functions	
	Handing required when ordering – How to order: RX-10G05 x LL x 26D x RH	\$206.00
LC	Less Cylinder	-\$94.00/cyl.
SC▲	Schlage C Keyway cylinder, 0 bitted	No addition
SE▲	Schlage E Keyway cylinder, 0 bitted	No addition
SF	L Lever to accept Schlage Large Format Interchangeable Core (supplied less core, tailpiece included)	No Addition
SG	MicroShield® – an antimicrobial powder coat	\$73.00
WBS	Wrought Box Strike	No Addition

▲ Options NOT available with 50 function.

CPC Clear Powder Coat over 26D – 10G05 x GL x 26D x CPC \$67.00
All orders will continue to be handled as a "special" when CPC is ordered.

USA & Canada Prices Effective May 1, 2021

Rose Design:		Lever Design:				
G Rose L Rose		L – Lever B – Lever P – Lever		GL “G” Rose with “L” Lever	LB “L” Rose with “B” Lever	GP “G” Rose with “P” Lever
Function		Finish				
Single Cylinder		10BE/26D/BSP/WSP		03/04/09/10/10B/10BL/14/15/20D/26		
10G04	Storeroom/Closet					
10G05	Entry/Office		\$680.00			\$696.00
10G37	Classroom					
10G24	Entry		\$695.00			\$711.00
10G44	Service Station					
10G50	Hotel		\$755.00			\$771.00
10G54	Dormitory					
Double Cylinder						
10G16	Classroom Security/Public Entrance					
10G17	Utility/Asylum/Institutional					
10G26	Storeroom		\$782.00			\$798.00
10G30	Communicating					
10G38	Classroom security					
Non Keyed						
10U15	Passage		\$488.00			\$504.00
10G13	Exit					
10G15-3	Exit					
10U65	Privacy		\$581.00			\$597.00
10U68	Hospital Privacy					
10U93	1/2 Dummy Trim		\$211.00			\$219.00
10U94	Dummy Trim		\$423.00			\$439.00
10U94-2	Dummy Trim		\$428.00			\$444.00
Electro-Mechanical						
10G70-12V / 10G70-24V	Fail Safe		\$991.00			\$1,007.00
10G71-12V / 10G71-24V	Fail Secure					
Strikes - See catalog for available lip lengths		Specify Finish				
800	ANSI A115.2 T Strike (Standard) Lip Lengths available: 1", 1-1/4" (Standard), 1-1/2", 1-3/4", 2"					Refer to page BL-53
808	ANSI A115.2 – 4-7/8" Strike (Option 28-) Lip Lengths available: 1-1/8", 1-1/4" (Standard), 1-3/8", 1-5/8", 1-7/8", 2-1/8", 2-3/8", 2-5/8", 2-7/8"					Refer to page BL-53
AM-0044	Strike Box (Standard)					\$12.00
77-1141	Strike Box (Option 28-)					\$12.00

Note: Split finishes are available, price as higher finish. Order outside/inside and handing must be specified. Strike and latch front will match inside finish for RH/LH and outside finish for RHR/LHR.

BL-24 BORED LOCKS

SARGENT®

ASSA ABLOY

10-LINE OPTIONS

USA & Canada Prices Effective May 1, 2021

Options	Description	Price
1	Adapter plates for 1-3/8" thick door	\$28.00
10▲	SARGENT Signature Key System	\$63.00 / cyl.
11▲	SARGENT XC Key System (not available with 10, 22, SC, SE options)	No addition
1160▲	Sargent XC Large Format Interchangeable Plastic Disposable Construction Core	No addition
1163▲	Sargent XC Large Format Interchangeable Core Cylinder - Includes masterkeying charges	\$83.00
1164▲	Sargent XC Large Format Interchangeable Construction Core Cylinder	\$83.00
20	2-3/8" backset with 1" front	No addition
21▲	SARGENT Construction Key System (lost ball) Standard on new systems est. since 5/1/96	\$16.00 / cyl.
22▲	SARGENT Construction Key System (split key) For pre-established key systems only	\$32.00 / cyl.
23	Lockset x 3 - 3/4" Backset	\$10.00
25	Lockset x 5" Backset	\$15.00
28	Lockset x ANSI A-156.115 Strike – 1-1/4" Lip Standard Lip Lengths 1-1/8" or 1-3/8"	No addition
	Lip Lengths 1-5/8", 1-7/8", 2-1/8", 2-3/8", 2-5/8", 2-7/8"	\$11.00
30	10 Line lever to accept Schlage cylinder - no cylinder provided	No addition
36	6 Lobe security head screws	\$15.00
37	Spanner head screws	\$10.00
41	3/4" Throw with latch	\$106.00
60▲	SARGENT Large Format Interchangeable Plastic Disposable Construction Core	No addition
63▲	SARGENT Large Format Interchangeable Core Cylinder includes master and grandmaster keying charge	\$83.00 / cyl.
64▲	SARGENT Large Format Interchangeable Construction Core Cylinder	\$83.00
74	Lead Lining I/S Rose, O/S Rose, and Latch Tube	\$214.00 /lock
75	Tactile Warning - Milled on backside of inside lever	\$40.00
76	Tactile Warning - Milled on backside of outside lever	\$40.00
77	Tactile Warning - Milled on backside of both levers	\$80.00
85	Tactile Warning - Abrasive coating on inside lever	\$49.00
86	Tactile Warning - Abrasive coating on outside lever	\$49.00
87	Tactile Warning - Abrasive coating on both levers	\$98.00
BR	SARGENT Bump Resistant Cyls. (N/A w/10, 22, 30, 60, 63, 64, 70, 72, 73, 737P, KESO, SC, SE)	\$25.00 /cyl.
DG1	Patented Degree DG1 Key System	No addition
DG160	Hardware prepared for DG1-6300 Lg. Format IC cores, supplied with temporary plastic construction cores	No addition
DG163	Patented Degree DG1 Large Format Interchangeable Core Cylinder - Includes master keying charges	\$83.00
DG164	Hardware prepared for DG1-6300 Lg. Format IC cores, supplied with temporary keyed construction cores	\$83.00
DG2	Patented Degree DG2 Key System incorporating a locking sidebar	\$63.00/cyl.
DG260	Hardware prepared for DG2-6300 Lg. Format IC cores, supplied with temporary plastic construction cores	No addition
DG263	Patented Degree DG2 Large Format Interchangeable Core Cylinder - Includes master keying charges	\$146.00
DG264	Hardware prepared for DG2-6300 Lg. Format IC cores, supplied with temporary keyed construction cores	\$83.00
DG3	Patented Degree DG3 Key System incorporating a locking sidebar and UL437 listed	\$89.00/cyl.
DG360	Hardware prepared for DG3-6300 Lg. Format IC cores, supplied with temporary plastic construction cores	No addition
DG363	Patented Degree DG3 Large Format Interchangeable Core Cylinder - Includes master keying charges	\$172.00
DG364	Hardware prepared for DG3-6300 Lg. Format IC cores, supplied with temporary keyed construction cores	\$83.00
LC	Less Cylinder	-\$94.00/cyl.
RX	Request to Exit (available with 04, 05, 37, 15, 70-12v & 24v, and 71-12v & 24v) functions Handing required when ordering – How to order: RX-10G05 x LL x 26D x RH	\$206.00
SC▲	Schlage C Keyway cylinder, 0 bitted	No Addition
SE▲	Schlage E Keyway cylinder, 0 bitted	No Addition
SG	MicroShield® – an antimicrobial powder coat	\$73.00
WBS	Wrought Box Strike	No Addition



▲ Options NOT available with 50 function.

CPC Clear Powder Coat over 26D – 10G05 x LJ x 26D x CPC \$67.00
All orders will continue to be handled as a "special" when CPC is ordered.

Experience a safer
and more open world

Copyright © 2002-2021 Sargent Manufacturing Company, an ASSA ABLOY Group company. All rights reserved.
Reproduction in whole or in part without the express written permission of Sargent Manufacturing Company is prohibited.
Contact us at: 800-727-5477 or visit www.sargentlock.com. In Canada contact us at: 800-461-3007 or visit www.assaabloydss.ca

USA & Canada Prices Effective May 1, 2021

Function	Finish	
	10BE/26D/BSP/WSP	03/04/09/10/10B/10BL/14/15/20D/26
Rose Design: G Rose L Rose		
Lever Design: J – Lever		
		
	“L” Rose with “J” Lever	“G” Rose with “J” Lever
Single Cylinder		
10G04 Storeroom		
10G05 Office	\$700.00	\$716.00
10G37 Classroom		
10G24 Dormitory	\$719.00	\$735.00
10G44 Service Station		
10G50 Hotel	\$791.00	\$807.00
10G54 Dormitory		
Double Cylinder		
10G16 Public Entrance		
10G17 Asylum		
10G26 Storeroom	\$826.00	\$842.00
10G30 Communicating		
10G38 Classroom Security		
Non Keyed		
10U15 Passage	\$508.00	\$524.00
10G13 Exit		
10G15-3 Exit	\$582.00	\$598.00
10U65 Privacy		
10U93 1/2 Dummy Trim	\$221.00	\$229.00
10U94 Dummy Trim	\$446.00	\$462.00
10U94-2 Dummy Trim	\$451.00	\$467.00
Electro-Mechanical		
10G70-12V / 10G70-24V Fail Safe	\$1,009.00	\$1,025.00
10G71-12V / 10G71-24V Fail Secure		
Strikes - See catalog for available lip lengths		Specify Finish
800	ANSI A115.2 T Strike (Standard) Lip Lengths available: 1", 1-1/4" (Standard), 1-1/2", 1-3/4", 2"	Refer to page BL-53
808	ANSI A115.2 – 4-7/8" Strike (Option 28-) Lip Lengths available: 1-1/8", 1-1/4" (Standard), 1-3/8", 1-5/8", 1-7/8", 2-1/8", 2-3/8", 2-5/8", 2-7/8"	Refer to page BL-53
AM -0044	Strike Box (Standard)	\$12.00
77-1141	Strike Box (Option 28-)	\$12.00



Note: Split finishes are available, price as higher finish. Order outside/inside and handing must be specified. Strike and latch front will match inside finish for RH/LH and outside finish for RHR/LHR.

10-LINE COASTAL SERIES OPTIONS

USA & Canada Prices Effective May 1, 2021

Options	Description	Price
1	Adapter plates for 1-3/8" thick door	\$28.00
10▲	SARGENT Signature Key System	\$63.00 / cyl.
11▲	SARGENT XC Key System (not available with 10, 22, SC, SE options)	No addition
1160▲	Sargent XC Large Format Interchangeable Plastic Disposable Construction Core	No addition
1163▲	Sargent XC Large Format Interchangeable Core Cylinder - Includes masterkeying charges	\$83.00
1164▲	Sargent XC Large Format Interchangeable Construction Core Cylinder	\$83.00
1170	Small Format interchangeable disposable construction core - to accept 7 Pin XC permanent core	No addition
11727P	Small Format interchangeable keyed construction core - to accept 7 Pin XC permanent core	75
11737P	Small Format interchangeable core - to accept 7 pin XC permanent core	\$75.00
20	2-3/8" backset with 1" front	No addition
21▲	SARGENT Construction Key System (lost ball) Standard on new systems est. since 5/1/96	\$16.00 / cyl.
22▲	SARGENT Construction Key System (split key) For pre-established key systems only	\$32.00 / cyl.
23	Lockset x 3 - 3/4" Backset	\$10.00
25	Lockset x 5" Backset	\$15.00
28	Lockset x ANSI A-156.115 Strike – 1-1/4" Lip Standard Lip Lengths 1-1/8" or 1-3/8"	No addition
	Lip Lengths 1-5/8", 1-7/8", 2-1/8", 2-3/8", 2-5/8", 2-7/8"	\$11.00
30	Lever to accept Schlage cylinder - no cylinder provided	No addition
36	6 Lobe security head screws	\$15.00
37	Spanner head screws	\$10.00
41	3/4" Throw with latch	\$106.00
60▲	SARGENT Large Format Interchangeable Plastic Disposable Construction Core	No addition
63▲	SARGENT Large Format Interchangeable Core Cylinder includes master and grandmaster keying charge	\$83.00 / cyl.
64▲	SARGENT Large Format Interchangeable Construction Core Cylinder	\$83.00
70	Small Format interchangeable disposable plastic construction core	No addition
72	Small Format interchangeable 6-Pin construction core	\$75.00
73	Small Format interchangeable core 6-pin Includes MK and GMK keying charges	\$75.00
737P	Small Format interchangeable core 7-pin (refer to CK-12 for available keyways) Includes MK and GMK keying charges	\$75.00
74	Lead Lining I/S Rose, O/S Rose, and Latch Tube	\$214.00 /lock
80▲	Levers to accept KESO and Keso F1 cylinders – no cylinders provided	-\$94.00/cyl.
F182▲	SARGENT KESO Security Cylinder – patented – new key systems	\$91.00 /cyl.
82▲	SARGENT KESO Security Cylinder (L,B,P levers only)	\$91.00 / cyl.
85	Tactile Warning - Abrasive coating on inside lever	\$49.00
86	Tactile Warning - Abrasive coating on outside lever	\$49.00
87	Tactile Warning - Abrasive coating on both levers	\$98.00
BR	SARGENT Bump Resistant Cyls. (N/A w/10, 22, 30, 60, 63, 64, 70, 72, 73, 737P, KESO, SC, SE)	\$25.00 /cyl.
DG1	Patented Degree DG1 Key System	No addition
DG160	Hardware prepared for DG1-6300 Lg. Format IC cores, supplied with temporary plastic construction cores	No addition
DG163	Patented Degree DG1 Large Format Interchangeable Core Cylinder - Includes master keying charges	\$83.00
DG164	Hardware prepared for DG1-6300 Lg. Format IC cores, supplied with temporary keyed construction cores	\$83.00
DG2	Patented Degree DG2 Key System incorporating a locking sidebar	\$63.00/cyl.
DG260	Hardware prepared for DG2-6300 Lg. Format IC cores, supplied with temporary plastic construction cores	No addition
DG263	Patented Degree DG2 Large Format Interchangeable Core Cylinder - Includes master keying charges	\$146.00
DG264	Hardware prepared for DG2-6300 Lg. Format IC cores, supplied with temporary keyed construction cores	\$83.00
DG3	Patented Degree DG3 Key System incorporating a locking sidebar and UL437 listed	\$89.00/cyl.
DG360	Hardware prepared for DG3-6300 Lg. Format IC cores, supplied with temporary plastic construction cores	No addition
DG363	Patented Degree DG3 Large Format Interchangeable Core Cylinder - Includes master keying charges	\$172.00
DG364	Hardware prepared for DG3-6300 Lg. Format IC cores, supplied with temporary keyed construction cores	\$83.00
FW	Freewheeling Locking Levers – Not available w/10G70, 10G71 functions	\$-
LC	Less Cylinder	-\$94.00/cyl.
RX	Request to Exit (available with 04, 05, 37, 15, 70-12v & 24v, and 71-12v & 24v) functions Handing required when ordering – How to order: RX-10G05 x LL x 26D x RH	\$206.00
SC▲	Schlage C Keyway cylinder, 0 bitted	No Addition
SE▲	Schlage E Keyway cylinder, 0 bitted	No Addition
SG	MicroShield® – an antimicrobial powder coat	\$73.00
WBS	Wrought Box Strike	No Addition
▲	Options <u>NOT</u> available with 50 function.	
CPC	Clear Powder Coat over 26D – 10G05 x GY x 26D x CPC All orders will continue to be handled as a "special" when CPC is ordered.	\$67.00

USA & Canada Prices Effective May 1, 2021

Function	Finish	
	10BE/26D/BSP/WSP	03/04/09/10/10B/10BL/14/15/20D/26
Rose Design: G – Rose L – Rose		
Lever Design: *Y – Lever *G – Lever *Handed – Specify hand when ordering		
	 GY "G" Rose with "Y" Lever	 GG "G" Rose with "G" Lever
Single Cylinder		
10G04 Storeroom/Closet		
10G05 Entry/Office	\$700.00	\$716.00
10G37 Classroom		
10G24 Entry	\$719.00	\$735.00
10G44 Service Station		
10G50 Hotel	\$791.00	\$807.00
10G54 Dormitory		
Double Cylinder		
10G16 Classroom Security/Public Entrance		
10G17 Utility/Asylum/Institutional		
10G26 Storeroom	\$826.00	\$842.00
10G30 Communicating		
10G38 Classroom security		
Non Keyed		
10U15 Passage	\$508.00	\$524.00
10G13 Exit		
10G15-3 Exit		
10U65 Privacy	\$582.00	\$598.00
10U68 Hospital Privacy		
10U93 1/2 Dummy Trim	\$221.00	\$229.00
10U94 Dummy Trim	\$446.00	\$462.00
10U94-2 Dummy Trim	\$451.00	\$467.00
Electro-Mechanical		
10G70-12V / 10G70-24V Fail Safe	\$1,009.00	\$1,025.00
10G71-12V / 10G71-24V Fail Secure		
Strikes - See catalog for available lip lengths		
		Specify Finish
800	ANSI A115.2 T Strike (Standard) Lip Lengths available: 1", 1-1/4" (Standard), 1-1/2", 1-3/4", 2"	Refer to page BL-53
808	ANSI A115.2 – 4-7/8" Strike (Option 28-) Lip Lengths available: 1-1/8", 1-1/4" (Standard), 1-3/8", 1-5/8", 1-7/8", 2-1/8", 2-3/8", 2-5/8", 2-7/8"	Refer to page BL-53
AM-0044	Strike Box (Standard)	\$12.00
77-1141	Strike Box (Option 28-)	\$12.00

Note: Split finishes are available, price as higher finish. Order outside/inside and handing must be specified. Strike and latch front will match inside finish for RH/LH and outside finish for RHR/LHR.

BL-28 BORED LOCKS

SARGENT®

10-LINE LEVERS

ASSA ABLOY

USA & Canada Prices Effective May 1, 2021

Lever Handles		Finish
Part #	Description (Inside or Outside)	03/04/09/10/10B/10BE/10BL/14/15/20D/26/26D/BSP/WSP
10-0501	"L" design, Passage	
10-0502	"L" design, Cylinder, Emergency Release (65)	
10-0503	"L" design, All Buttons	
10-0504	"L" design prepared for SARGENT Removable core cylinder	
10-0506	"L" design prepared for SARGENT KESO 82- cylinder	
10-0507	"L" design prepared for SF- option Schlage LFIC	
10-0505	"L" design prepared for Interchangeable core cylinder 70-	
10-0545	"P" design, Passage	
10-0546	"P" design, Cylinder, Emergency Release (65)	
10-0547	"P" design, Turn Button, T-Turn and 30- option	
10-0548	"P" design prepared for SARGENT Removable core cylinder	
10-0550	"P" design prepared for SARGENT KESO 82- cylinder	
10-0549	"P" design prepared for Interchangeable core cylinder 72-	\$76.00
10-0523	"B" design, Passage	
10-0524	"B" design, Cylinder, Emergency Release (65)	
10-0525	"B" design, Turn Button, T-Turn and 30- option	
10-0526	"B" design prepared for SARGENT Removable core cylinder	
10-0528	"B" design prepared for SARGENT KESO 82- cylinder	
10-0527	"B" design prepared for Interchangeable core cylinder 72-	
10-2204	"J" design, Passage	
10-2205	"J" design, Cylinder, Emergency Release (65)	\$84.00
10-2206	"J" design, Turn Button, T-Turn and 30- option	
10-2207	"J" design prepared for SARGENT Removable core cylinder 60-	

Lever Handles w/Handicap Warning		Finish
Part #	Description (Inside or Outside)	03/04/09/10/10B/10BE/10BL/14/15/20D/26/26D/BSP/WSP
10-0512	"L" design, Passage	
10-0513	"L" design, Cylinder, Emergency Release (65)	
10-0514	"L" design, Turn Button, T-Turn and 30- option	
10-0515	"L" design prepared for SARGENT Removable core cylinder	
10-0516	"L" design prepared for SARGENT Interchangeable 72- core cylinder	
10-0517	"L" design prepared for SARGENT KESO 82- cylinder	
10-0518	"L" design prepared for LFIC/SC SFIC	
10-0556	"P" design, Passage	
10-0557	"P" design, Cylinder, Emergency Release (65)	
10-0558	"P" design, Turn Button, T-Turn and 30- option	
10-0559	"P" design prepared for SARGENT Removable core cylinder	
10-0560	"P" design prepared for SARGENT Interchangeable 72- core cylinder	
10-0561	"P" design prepared for SARGENT KESO 82- cylinder	\$116.00
10-2245	"J" design, Passage	
10-2246	"J" design, Cylinder, Emergency Release (65)	
10-2247	"J" design, Turn Button, T-Turn and 30- option	
10-2248	"J" design prepared for SARGENT Removable core cylinder	
10-0534	"B" design, Passage	
10-0535	"B" design, Cylinder, Emergency Release (65)	
10-0536	"B" design, Turn Button, T-Turn and 30- option	
10-0537	"B" design prepared for SARGENT Removable core cylinder	
10-0538	"B" design prepared for SARGENT Interchangeable 72- core cylinder	
10-0539	"B" design prepared for SARGENT KESO 82- cylinder	

Experience a safer
and more open world

Copyright © 2002-2021 Sargent Manufacturing Company, an ASSA ABLOY Group company. All rights reserved.
Reproduction in whole or in part without the express written permission of Sargent Manufacturing Company is prohibited.
Contact us at: 800-727-5477 or visit www.sargentlock.com. In Canada contact us at: 800-461-3007 or visit www.assaabloydss.ca

10-LINE COASTAL SERIES LEVERS

USA & Canada Prices Effective May 1, 2021

Lever Handles - Coastal Series Design		Finish
Part #	Description (Inside or Outside)	03/04/09/10/10B/10BE/10BL/14/15/20D/26/26D/BSP/WSP
10-0611	"Y" design, Passage - Left	
10-0612	"Y" design, Passage - Right	
10-0613	"Y" design, Cylinder and emergency release (65) - Left	
10-0614	"Y" design, Cylinder and emergency release (65) - Right	
10-0615	"Y" design, Turn Button, T-Turn and 30- option - Left	
10-0616	"Y" design, Turn Button, T-Turn and 30- option - Right	
10-0617	"Y" design prepared for SARGENT Removable core cylinder - Left	
10-0618	"Y" design prepared for SARGENT Removable core cylinder - Right	
10-0619	"Y" design prepared for SARGENT Interchangeable 72- core cylinder - Left	
10-0620	"Y" design prepared for SARGENT Interchangeable 72- core cylinder - Right	
10-0621	"Y" design prepared for SARGENT KESO 82- cylinder - Left	
10-0622	"Y" design prepared for SARGENT KESO 82- cylinder - Right	
10-0567	"G" design, Passage - Left	\$76.00
10-0568	"G" design, Passage - Right	
10-0569	"G" design, Cylinder and emergency release (65)- Left	
10-0570	"G" design, Cylinder and emergency release (65)- Right	
10-0571	"G" design, Turn Button, T-Turn and 30- option - Left	
10-0572	"G" design, Turn Button, T-Turn and 30- option - Right	
10-0573	"G" design prepared for SARGENT Removable core cylinder - Left	
10-0574	"G" design prepared for SARGENT Removable core cylinder - Right	
10-0575	"G" design prepared for SARGENT Interchangeable 72- core cylinder - Left	
10-0576	"G" design prepared for SARGENT Interchangeable 72- core cylinder - Right	
10-0577	"G" design prepared for SARGENT KESO 82- cylinder - Left	
10-0578	"G" design prepared for SARGENT KESO 82- cylinder - Right	

Lock Replacement Kits - For 7600 Integra Locks (See catalog)		Finish	
Number	Description	10BE/26D	03/04/10/10B
		BSP/WSP10BL/20D/26	
* 6010	For replacing 7600 with C768 or C769 strike Specify 6010 x 800 to replace 762 strike.	\$102.00	\$112.00
6011	Lock replacement units – larger cover plates	\$234.00	\$250.00
6012	Lock replacement units – larger cover plates		

* Retro fits lock fronts with front face of 4-1/4" x 1-1/4" and strikes 2-3/4" high (800) and 4-7/8" high (808).

Note: Must specify if intending to use with 10-Line lockset.

BL-30 BORED LOCKS

SARGENT®

10-LINE ROSES/LATCHES/ASSEMBLIES

ASSA ABLOY

USA & Canada Prices Effective May 1, 2021

Roses		10BE/26D/BSP/WSP	03/04/09/10/10B/10BL/14/15/20D/26
10-0798	Inside and outside Rose Scalp – L	\$47.51	\$71.24
10-0790	Inside and outside Rose Scalp – G	\$65.76	\$89.56
10-3048	Inside Rose Spring Assy. (not finished)	\$82.26	\$82.26
10-3049	Outside Rose Spring Assy. (not finished)	\$83.46	\$83.46
10-3050	Rose Spring Assy. (10G15-3) function only	\$65.76	\$89.56
Latch Units			
Standard 2-3/4" Backset		03/04/09/10/10B/10BE/10BL/20D/32D/BSP/WSP	
10-3192	Guarded Latch		\$63.11
10-2022	Unguarded Latch		\$59.82
20 Option 2-3/8" Backset		03/04/09/10/10B/10BE/10BL/20D/32D/BSP/WSP	
10-3186	Guarded Latch 2-3/8"		\$76.04
10-3187	Unguarded Latch 2-3/8"		\$71.44
23 Option 3-3/4" Backset		03/04/09/10/10B/10BE/10BL/20D/32D/BSP/WSP	
10-2053	Guarded Latch		\$91.12
10-2054	Unguarded Latch		\$88.34
25 Option 5" Backset		03/04/09/10/10B/10BE/10BL/20D/32D/BSP/WSP	
10-2058	Guarded Latch		\$105.15
10-2057	Unguarded Latch		\$102.36
41 Option 2-3/4" Backset with 3/4" Throw		04/26D	
10-2634	Guarded Latch		\$139.54
Extension Only			
10-2059	3-3/4" Extension (add to 2-3/4" BS Latchbolt) 23- option		\$56.10
10-2060	5" Extension (add to 2-3/4" BS Latchbolt) 25- option		\$56.10
10-0048	Extension Cover Sleeve (Plastic)		\$4.77
Lock Body Assemblies For non-cylinder and standard cylinder and 10-, 21-, 22-, 30-, SC-, & SE- options			
Part #	Function	Specify Finish	
10-2538	04		
* 10-2543	05		
10-2547	13		
10-2548	15		
10-3054	15-3		
10-2550	16		
10-2555	17		
* 10-2560	24		\$295.98
10-3095	26		
10-2565	30		
10-2570	37		
10-3035	38		
* 10-2575	44		
* 10-2579	50		
* 10-2581	54		
* 10-3044	68 – emergency turn button not included		
10-2587	70		
10-2592	71		\$531.42

Experience a safer
and more open world

Copyright © 2002-2021 Sargent Manufacturing Company, an ASSA ABLOY Group company. All rights reserved.
Reproduction in whole or in part without the express written permission of Sargent Manufacturing Company is prohibited.
Contact us at: 800-727-5477 or visit www.sargentlock.com. In Canada contact us at: 800-461-3007 or visit www.assaabloydss.ca

10-LINE LOCKBODY ASSEMBLIES

USA & Canada Prices Effective May 1, 2021

Lock Body Assemblies To Accept SARGENT Removable Core Cylinders (60-, 63-, 64-Options)

Part #	Function	Specify Finish
10-2539	04	
* 10-2544	05	
10-2551	16	
10-2556	17	
* 10-2561	24	
10-3096	26	\$303.30
10-2566	30	
10-2571	37	
10-3036	38	
* 10-2576	44	
* 10-2582	54	
10-2588	70	
10-2593	71	\$538.74

Lock Body Assemblies To Accept SARGENT KESO Cylinder (82-Option)

Part #	Function	Specify Finish
10-2541	04	
* 10-2546	05	
10-2553	16	
10-2558	17	
* 10-2563	24	
10-3098	26	\$308.82
10-2568	30	
10-2573	37	
10-3038	38	
* 10-2578	44	
* 10-2584	54	
10-2590	70	
10-2595	71	\$544.25

Lock Body Assemblies To Accept Arrow, Best, Falcon Interchangeable core Cylinders

Part #	Function	(70-, 72-, 65-73-, 65-73-7P, 73, 73-7P)*	Specify Finish
10-2540	04		
* 10-2545	05		
10-2552	16		
10-2557	17		
* 10-2562	24		
10-3097	26		\$308.82
10-2567	30		
10-2572	37		
10-3037	38		
* 10-2577	44		
* 10-2583	54		
10-2589	70		
10-2594	71		\$544.25

* Order by Finish 03/04/09/10/10B/10BE/10BL/15/20D/26/26D

BL-32 BORED LOCKS

SARGENT®

ASSA ABLOY

10-LINE FW LOCKBODY ASSEMBLIES

USA & Canada Prices Effective May 1, 2021

Freewheel Lock body Assy for non-cylinder and standard cylinder (10, 11, 21, 22, SC, SE option)		Specify Finish
Part #	Function	
10-2686	04	
* 10-2691	05	
10-3085	13	
10-3086	16	
10-3090	17	
* 10-2707	24	
10-3099	26	\$309.28
10-3103	30	
10-2717	37	
* 10-3112	44	
* 10-3116	50	
* 10-3117	54	
* 10-3121	65, 68 – order emergency button separately	
Freewheel Lockbody Assy to accept SARGENT Removable Core Cylinders (51, 52, 60, 63, 64 option)		
10-2687	04	
* 10-2692	05	
10-3087	16	
10-3091	17	
* 10-2708	24	
10-3100	26	\$316.58
10-3104	30	
10-2718	37	
* 10-3113	44	
* 10-3118	54	
Freewheel Lockbody Assy to accept Interchangeable Core Cylinders (65-73, 65-73-7P, 70, 72, 73, 73-7P option)		
10-2688	04	
* 10-2693	05	
10-3088	16	
10-3092	17	
* 10-2709	24	
10-3101	26	\$322.08
10-3105	30	
10-2719	37	
10-3114	44	
* 10-3119	54	
Freewheel Lockbody Assy to accept SARGENT KESO cylinder (82 option)		
10-3083	04	
* 10-3084	05	
10-3089	16	
10-3093	17	
* 10-3094	24	
10-3102	26	\$322.08
10-3106	30	
10-3107	37	
* 10-3115	44	
* 10-3120	54	
Lock Body Assemblies For SF option		
10-3157	04	
* 10-3158	05	
10-3159	16	
10-3160	17	
* 10-3161	24	
10-3162	26	\$303.30
10-3163	30	
10-3164	37	
10-3165	38	
* 10-3166	44	
* 10-3167	54	
10-3168	70	\$538.74
10-3169	71	
Lock Body Assemblies For FW&SF option		
10-3175	04	
* 10-3176	05	
10-3177	16	
10-3178	17	
* 10-3179	24	
10-3180	26	\$316.58
10-3181	30	
10-3182	37	
10-3183	38	
* 10-3184	44	
* 10-3185	54	

Experience a safer
and more open world

Copyright © 2002-2021 Sargent Manufacturing Company, an ASSA ABLOY Group company. All rights reserved.
Reproduction in whole or in part without the express written permission of Sargent Manufacturing Company is prohibited.
Contact us at: 800-727-5477 or visit www.sargentlock.com. In Canada contact us at: 800-461-3007 or visit www.assaabloydss.ca

Miscellaneous		Price
01-0949	Washer only (30- option) for cylinder (order 2 per lock)	\$0.89
01-4414	Screw Phillips Pan-head #6 x 3/4" (order 4 per lock)	\$0.35
*08-2842	Dummy Front (94-2 function)	\$21.44
10-0019	Cylinder Spacer (white plastic disk)	\$0.71
10-0042	Lockout Key (50 function-for inside push button only)	\$3.82
10-0043	Push Pin Tool	\$0.58
10-0055	Spring (13 function)	\$0.97
10-0056	Lever Catch Plug Key - 13 function (long push pin tool)	\$2.73
10-0195	Retractor spring for lockbody (all functions, inside lockbody - 2 per lock)	\$0.84
10-0239	6-Pin Tailpiece (Removable & Interchangeable Cores)	\$2.05
10-0240	7-Pin Tailpiece (Interchangeable Core)	\$1.91
10-0288	Lead Lining Plate for Rose (1)	\$13.28
10-0312	Cylinder Retainer (required for cylinder lever - standard) - plastic	\$1.66
10-0792	Spacer Bushing	\$2.51
10-0833	Screw Retainer	\$0.35
*10-2052	Screw Pack (Standard) - for (2) latchbolt, (2) strike, & (2) surface screws	\$4.99
*10-2070	Screw Pack (28 Option) - for (2) latchbolt, (2) strike, & (2) surface screws	\$2.00
10-2071	Screw Pack (Dummy Trim - 94 & 94-2 function)	\$1.66
10-2078	Key Cam Ext. & Pin Assy. (Removable Core - standard)	\$20.27
10-2090	Cyl. Retainer & Washer Pack (30- Option)	\$9.17
10-2185	Key Cam Ext. & Pin Assy. (Removable Core - 54 function only)	\$20.27
10-3122	10U93 Support Plate	\$59.66
10-3123	10U94 Outside Support Plate	\$61.29
10-3124	10U94 Inside Support Plate	\$70.97
10-3138	Cylinder Tailpiece Pack for 11-IC cores	\$6.58
10-3188	Adapter plate pack, 1-3/8 dr (1 pack required per lock)	\$47.94
10-3428	Tailpiece Pack, SF-Option	\$9.99
13-0896	Cylinder tailpiece - 10 Line 50 function only	\$2.05
14-0057	Emergency Release Key (65 function only)	\$1.86
14-0299	Lockout Key (10G50 function-for inside button)	\$5.48
*C10-3	Emergency Release Cylinder (65 function)	\$58.66

* Order by Finish 3, 4, 9, 10,10B, 15, 26, 26D

Note: See page BL-23 for replacement kits for 7600 Integra Locks. Must specify if intending to use with 10-Line lockset.

BL-34 BORED LOCKS

SARGENT®

ASSA ABLOY

7-LINE OPTIONS



USA & Canada Prices Effective May 1, 2021

Options	Description	Price
1-	7 Line Lock for 1-3/8" door (Shim Kits)	No addition
10	SARGENT Signature Key System	\$63.00 / cyl.
11	SARGENT XC Key System (not available with 10, 22, SC, SE options)	No addition
1160	Sargent XC Large Format Interchangeable Plastic Disposable Construction Core	No addition
1163	Sargent XC Large Format Interchangeable Core Cylinder - Includes masterkeying charges	\$83.00
1164	Sargent XC Large Format Interchangeable Construction Core Cylinder	\$83.00
1170	Small Format interchangeable disposable construction core - to accept 7 Pin XC permanent core	No addition
11727P	Small Format interchangeable keyed construction core - to accept 7 Pin XC permanent core	75
11737P	Small Format interchangeable core - to accept 7 pin XC permanent core	\$75.00
14	505 Full Lip Strike	No addition
20	2-3/8" Backset Latch w/shim kits to fit 1-3/8" door	No addition
21	SARGENT Construction Key System (lost ball) Standard on all new systems est. since 5/1/96	\$16.00 / cyl.
22	SARGENT Construction Key System (split key) To be used on pre-est. split key systems only	\$32.00 / cyl.
28	Lockset x ANSI A-156.115 Strike – 1-1/4" Lip Standard	
	Lip Lengths 1-1/8" or 1-3/8"	No addition
	Lip Lengths 1-5/8", 1-7/8", 2-1/8", 2-3/8", 2-5/8", 2-7/8"	\$11.00
30	7 Line Lever to accept Schlage cylinder - no cylinder provided	No addition
36	6 Lobe Security Head Screws	\$15.00
37	Spanner Head Screws	\$10.00
60	SARGENT Large Format Interchangeable Plastic Disposable Construction Core	No addition
63	SARGENT Large Format Interchangeable Core Cylinder	
	includes master and grandmaster keying charge	\$83.00 / cyl.
64	SARGENT Large Format Interchangeable Construction Core Cylinder	\$83.00
6573	Small Format 6-Pin Uncombined Cores	\$65.00 / cyl.
65737P	Small Format 7-Pin Uncombined Cores	\$65.00 / cyl.
70	Small Format Interchangeable disposable plastic construction core	No addition
72	Small Format Interchangeable 6 Pin Construction core (7-Pin w/11- option)	\$75.00
73	Small Format Interchangeable Core, 6-Pin	
	Includes MK and GMK keying charges	\$75.00 / cyl.
737P	Small Format Interchangeable Core, 7-Pin	
	Includes MK and GMK keying charges	\$75.00 / cyl.
74	Lead Lining I/S Rose, O/S Rose, and Latch Tube	\$214.00
75	Tactile Warning - Milled on backside of inside lever	\$40.00
76	Tactile Warning - Milled on backside of outside lever	\$40.00
77	Tactile Warning - Milled on backside of both levers	\$80.00
80	Levers to accept KESO and Keso F1 cylinders – no cylinders provided	-\$94.00/cyl.
F182	SARGENT KESO Security Cylinder – patented – new key systems	\$91.00 /cyl.
82	SARGENT KESO Security Cylinder – existing key systems ONLY	\$91.00 /cyl.
85	Tactile Warning - Abrasive coating on inside lever	\$49.00
86	Tactile Warning - Abrasive coating on outside lever	\$49.00
87	Tactile Warning - Abrasive coating on both levers	\$98.00
BR	SARGENT Bump Resistant Cyls. (N/A w/10, 22, 30, 60, 63, 64, 70, 72, 73, 737P, KESO, SC, SE)	\$25.00 /cyl.
DG1	Patented Degree DG1 Key System	No addition
DG160	Hardware prepared for DG1-6300 Lg. Format IC cores, supplied with temporary plastic construction cores	No addition
DG163	Patented Degree DG1 Large Format Interchangeable Core Cylinder - Includes master keying charges	\$83.00
DG164	Hardware prepared for DG1-6300 Lg. Format IC cores, supplied with temporary keyed construction cores	\$83.00
DG2	Patented Degree DG2 Key System incorporating a locking sidebar	\$63.00/cyl.
DG260	Hardware prepared for DG2-6300 Lg. Format IC cores, supplied with temporary plastic construction cores	No addition
DG263	Patented Degree DG2 Large Format Interchangeable Core Cylinder - Includes master keying charges	\$146.00
DG264	Hardware prepared for DG2-6300 Lg. Format IC cores, supplied with temporary keyed construction cores	\$83.00
DG3	Patented Degree DG3 Key System incorporating a locking sidebar and UL437 listed	\$89.00/cyl.
DG360	Hardware prepared for DG3-6300 Lg. Format IC cores, supplied with temporary plastic construction cores	No addition
DG363	Patented Degree DG3 Large Format Interchangeable Core Cylinder - Includes master keying charges	\$172.00
DG364	Hardware prepared for DG3-6300 Lg. Format IC cores, supplied with temporary keyed construction cores	\$83.00
FW	Freewheeling Locking Levers – 04, 05, 37, 65 Functions	\$0.00
LC	Less Cylinder	-\$94.00/cyl.
SC	Schlage C Keyway Cylinder, 0-bitted	No addition
SE	Schlage E Keyway Cylinder, 0-bitted	No addition
SF	L Lever to accept Schlage Large Format Interchangeable Core (supplied less core, tailpiece included)	No addition
SG	MicroShield® – an antimicrobial powder coat	
\$73.00		
WBS	Wrought Box Strike	No Addition
CPC	Clear Powder Coat over 26D – 7G05 x LL x 26D x CPC All orders will continue to be handled as a "special" when CPC is ordered.	\$67.00

Experience a safer
and more open world

Copyright © 2002-2021 Sargent Manufacturing Company, an ASSA ABLOY Group company. All rights reserved.
Reproduction in whole or in part without the express written permission of Sargent Manufacturing Company is prohibited.
Contact us at: 800-727-5477 or visit www.sargentlock.com. In Canada contact us at: 800-461-3007 or visit www.assaabloydss.ca

USA & Canada Prices Effective May 1, 2021

Rose Design: L – Rose		Lever Design: L – Lever B – Lever P – Lever										
				LL	LB	LP						
				"L" Rose with "L" Lever			"L" Rose with "B" Lever			"L" Rose with "P" Lever		
Function							Finish					
Cylinder							10BE/26D BSP/WSP			03/04/09/10/10B, 10BL/14/15/20D/26		
7G04	Storeroom/Closet											
7G05	Entrance/Office						\$311.00					\$327.00
7G37	Classroom											
Non Keyed												
7U15	Passage						\$228.00					\$244.00
7G15-3	Communicating											
7U65	Privacy						\$249.00					\$265.00
7U68	Hospital/Privacy											
7U93	Single Lever Pull						\$130.00					\$138.00
7U94	Double lever pull											
7U94-2	Double lever pull x Latchbolt Plate						\$241.00					\$257.00
Strikes												
505	Full Lip Strike (not available in longer lip lengths)											\$18.10
800	ANSI A115.2 T Strike (Standard)											
	Lip Lengths available: 1", 1-1/4" (Standard), 1-1/2", 1-3/4", 2"											Refer to page BL-53
808	ANSI A115.2 – 4-7/8" Strike (Option 28-)											
	Lip Lengths available: 1-1/8", 1-1/4" (Standard), 1-3/8", 1-5/8", 1-7/8", 2-1/8", 2-3/8", 2-5/8", 2-7/8"											Refer to page BL-53
AM-0044	Strike Box (Standard)											\$12.00
77-1141	Strike Box (Option 28-)											\$12.00

NOTE: Split finishes are available, price as higher finish. Order outside/inside and handing must be specified. Strike and latch front will match inside finish for RH/LH and outside finish for RHR/LHR.

7-LINE COASTAL SERIES OPTIONS

USA & Canada Prices Effective May 1, 2021

Options	Description	Price
1-	7 Line Lock for 1-3/8" door (Shim Kits)	No addition
10	SARGENT Signature Key System	\$63.00 / cyl.
11	SARGENT XC Key System (not available w/10, 22, 30, 60, 63, 64, SC, SE, VA, VS options)	No addition
1160	Sargent XC Large Format Interchangeable Plastic Disposable Construction Core	No addition
1163	Sargent XC Large Format Interchangeable Core Cylinder - Includes masterkeying charges	\$83.00
1164	Sargent XC Large Format Interchangeable Construction Core Cylinder	\$83.00
1170	Small Format interchangeable disposable construction core - to accept 7 Pin XC permanent core	No addition
11727P	Small Format interchangeable keyed construction core - to accept 7 Pin XC permanent core	75
11737P	Small Format interchangeable core - to accept 7 pin XC permanent core	\$75.00
14	505 Full Lip Strike	No addition
20	2-3/8" Backset Latch w/shim kits to fit 1-3/8" door	No addition
21	SARGENT Construction Key System (lost ball) Standard on all new systems est. since 5/1/96	\$16.00 / cyl.
22	SARGENT Construction Key System (split key) To be used on pre-est. split key systems only	\$32.00 / cyl.
28	Lockset x ANSI A-156.115 Strike – 1-1/4" Lip Standard Lip Lengths 1-1/8" or 1-3/8" Lip Lengths 1-5/8", 1-7/8", 2-1/8", 2-3/8", 2-5/8", 2-7/8"	No addition \$11.00
30	7 Line Lever to accept Schlage cylinder - no cylinder provided	No addition
36	6 Lobe Security Head Screws	\$15.00
37	Spanner Head Screws	\$10.00
60	SARGENT Large Format Interchangeable Plastic Disposable Construction Core	No addition
63	SARGENT Large Format Interchangeable Core Cylinder includes master and grandmaster keying charge	\$83.00 / cyl.
64	SARGENT Large Format Interchangeable Construction Core Cylinder	\$83.00
6573	Small Format 6-Pin Uncombined Cores	\$65.00 / cyl.
65737P	Small Format 7-Pin Uncombined Cores	\$65.00 / cyl.
70	Small Format Interchangeable disposable plastic construction core	No addition
72	Small Format Interchangeable 6 Pin Construction core (7-Pin w/11- option)	\$75.00
73	Small Format Interchangeable Core, 6-Pin Includes MK and GMK keying charges	\$75.00 / cyl.
737P	Small Format Interchangeable Core, 7-Pin Includes MK and GMK keying charges	\$75.00 / cyl.
74	Lead Lining I/S Rose, O/S Rose, and Latch Tube	\$214.00
80	Levers to accept KESO and Keso F1 cylinders – no cylinders provided	-\$94.00/cyl.
F182	SARGENT KESO Security Cylinder – patented – new key systems	\$91.00 /cyl.
82	SARGENT KESO Security Cylinder – existing key systems ONLY	\$91.00 /cyl.
85	Tactile Warning - Abrasive coating on inside lever	\$49.00
86	Tactile Warning - Abrasive coating on outside lever	\$49.00
87	Tactile Warning - Abrasive coating on both levers	\$98.00
BR	SARGENT Bump Resistant Cyls. (N/A w/10, 22, 30, 60, 63, 64, 70, 72, 73, 737P, KESO, SC, SE)	\$25.00 /cyl.
DG1	Patented Degree DG1 Key System	No addition
DG160	Hardware prepared for DG1-6300 Lg. Format IC cores, supplied with temporary plastic construction cores	No addition
DG163	Patented Degree DG1 Large Format Interchangeable Core Cylinder - Includes master keying charges	\$83.00
DG164	Hardware prepared for DG1-6300 Lg. Format IC cores, supplied with temporary keyed construction cores	\$83.00
DG2	Patented Degree DG2 Key System incorporating a locking sidebar	\$63.00/cyl.
DG260	Hardware prepared for DG2-6300 Lg. Format IC cores, supplied with temporary plastic construction cores	No addition
DG263	Patented Degree DG2 Large Format Interchangeable Core Cylinder - Includes master keying charges	\$146.00
DG264	Hardware prepared for DG2-6300 Lg. Format IC cores, supplied with temporary keyed construction cores	\$83.00
DG3	Patented Degree DG3 Key System incorporating a locking sidebar and UL437 listed	\$89.00/cyl.
DG360	Hardware prepared for DG3-6300 Lg. Format IC cores, supplied with temporary plastic construction cores	No addition
DG363	Patented Degree DG3 Large Format Interchangeable Core Cylinder - Includes master keying charges	\$172.00
DG364	Hardware prepared for DG3-6300 Lg. Format IC cores, supplied with temporary keyed construction cores	\$83.00
FW	Freewheeling Locking Levers – 04, 05, 37, 65 Functions	\$-
LC	Less Cylinder	-\$94.00/cyl.
SC	Schlage C Keyway Cylinder, 0-bitted	No addition
SE	Schlage E Keyway Cylinder, 0-bitted	No addition
SG	MicroShield® – an antimicrobial powder coat	\$73.00
WBS	Wrought Box Strike	No Addition

CPC Clear Powder Coat over 26D – 7G05 x LY x 26D x CPC \$67.00
All orders will continue to be handled as a "special" when CPC is ordered.

Function Cylinder		Finish	
		10BE/26D BSP/WSP	03/04/09/10/10B/ 10BL/14/15/20D/26
7G04	Storeroom/Closet		
7G05	Entry/Office	\$329.00	\$345.00
7G37	Classroom		
Non Keyed			
7U15	Passage	\$246.00	\$262.00
7G15-3	Communicating		
7U65	Privacy	\$268.00	\$284.00
7U68	Hospital/Privacy		
7U93	Single Lever Pull	\$149.00	\$157.00
7U94	Double lever pull		
7U94-2	Double lever pull x Latchbolt Plate	\$260.00	\$276.00
Strikes - See catalog for available lip lengths		Specify Finish	
505	Full Lip strike (not available in longer lip lengths)		\$18.10
800	ANSI A115.2 T Strike (Standard) Lip Lengths available: 1", 1-1/4" (Standard), 1-1/2", 1-3/4", 2"		Refer to page BL-53
808	ANSI A115.2 – 4-7/8" Strike (Option 28-) Lip Lengths available: 1-1/8", 1-1/4" (Standard), 1-3/8", 1-5/8", 1-7/8", 2-1/8", 2-3/8", 2-5/8", 2-7/8"		Refer to page BL-53
AM-0044	Strike Box (Standard)		\$12.00
77-1141	Strike Box (Option 28-)		\$12.00

NOTE: Split finishes are available, price as higher finish. Order outside/inside and handing must be specified. Strike and latch front will match inside finish for RH/LH and outside finish for RHR/LHR.

BL-38 BORED LOCKS

7-LINE LEVERS

SARGENT®

ASSA ABLOY

USA & Canada Prices Effective May 1, 2021

Lever Handles		Finish
Part #	Description (Inside or Outside)	03/04/09/10/10B/10BE/10BL/14/15/20D/26/26D/BSP/WSP
10-0501	"L" design, Passage	
10-0502	"L" design, Cylinder, Emergency Release (65)	
10-0503	"L" design, Turn Button and 30- option	
10-0504	"L" design, prepared for SARGENT Removable core cylinder	
10-0505	"L" design, prepared for Interchangeable core cylinder 72-	
10-0506	"L" design, prepared for SARGENT Keso (82) cylinder	
10-0545	"P" design, Passage	
10-0546	"P" design, Cylinder, Emergency Release (65)	
10-0547	"P" design, Turn Button and 30- option	
10-0548	"P" design, prepared for SARGENT Removable core cylinder	\$76.00
10-0549	"P" design, prepared for Interchangeable core cylinder 72-	
10-0550	"P" design, prepared for SARGENT Keso (82) cylinder	
10-0523	"B" design, Passage	
10-0524	"B" design, Cylinder, Emergency Release (65)	
10-0525	"B" design, Turn Button and 30- option	
10-0526	"B" design, prepared for SARGENT Removable core cylinder	
10-0527	"B" design, prepared for Interchangeable core cylinder 72-	
10-0528	"B" design, prepared for SARGENT Keso (82) cylinder	
Lever Handles w/Handicap Warning		Finish
Part #	Description (Inside or Outside)	03/04/09/10/10B/10BE/10BL/14/15/20D/26/26D/BSP/WSP
10-0512	"L" design, Passage	
10-0513	"L" design, Cylinder, Emergency Release (65)	
10-0514	"L" design, Turn Button, T-Turn and 30- option	
10-0515	"L" design, prepared for SARGENT Removable core cylinder	
10-0516	"L" design, prepared for SARGENT Interchangeable 72- core cylinder	
10-0556	"P" design, Passage	
10-0557	"P" design, Cylinder, Emergency Release (65)	
10-0558	"P" design, Turn Button, T-Turn and 30- option	\$116.00
10-0559	"P" design, prepared for SARGENT Removable core cylinder	
10-0560	"P" design, prepared for SARGENT Interchangeable 72- core cylinder	
10-0534	"B" design, Passage	
10-0535	"B" design, Cylinder, Emergency Release (65)	
10-0536	"B" design, Turn Button, T-Turn and 30- option	
10-0537	"B" design, prepared for SARGENT Removable core cylinder	
10-0538	"B" design, prepared for SARGENT Interchangeable 72- core cylinder	

Experience a safer
and more open world

Copyright © 2002-2021 Sargent Manufacturing Company, an ASSA ABLOY Group company. All rights reserved.
Reproduction in whole or in part without the express written permission of Sargent Manufacturing Company is prohibited.
Contact us at: 800-727-5477 or visit www.sargentlock.com. In Canada contact us at: 800-461-3007 or visit www.assaabloydss.ca

7-LINE COASTAL SERIES LEVERS

USA & Canada Prices Effective May 1, 2021

Lever Handles - Coastal Series Design		Finish
Part #	Description (Inside or Outside)	03/04/09/10/10B/10BE/10BL/14/15/20D/26/26D/BSP/WSP
10-0611	"Y" design, Passage - Left	
10-0612	"Y" design, Passage - Right	
10-0613	"Y" design, Cylinder and emergency release (65) - Left	
10-0614	"Y" design, Cylinder and emergency release (65) - Right	
10-0615	"Y" design, Turn Button, T-Turn and 30- option - Left	
10-0616	"Y" design, Turn Button, T-Turn and 30- option - Right	
10-0617	"Y" design, prepared for SARGENT Removable core cylinder - Left	
10-0618	"Y" design, prepared for SARGENT Removable core cylinder - Right	
10-0619	"Y" design, prepared for SARGENT Interchangeable 72- core cylinder - Left	
10-0620	"Y" design, prepared for SARGENT Interchangeable 72- core cylinder - Right	
10-0621	"Y" design, prepared for SARGENT Keso (82) cylinder - Left	
10-0622	"Y" design, prepared for SARGENT Keso (82) cylinder - Right	
10-0567	"G" design, Passage - Left	\$76.00
10-0568	"G" design, Passage - Right	
10-0569	"G" design, Cylinder and emergency release (65) - Left	
10-0570	"G" design, Cylinder and emergency release (65) - Right	
10-0571	"G" design, Turn Button, T-Turn and 30- option - Left	
10-0572	"G" design, Turn Button, T-Turn and 30- option - Right	
10-0573	"G" design, prepared for SARGENT Removable core cylinder - Left	
10-0574	"G" design, prepared for SARGENT Removable core cylinder - Right	
10-0575	"G" design, prepared for SARGENT Interchangeable 72- core cylinder - Left	
10-0576	"G" design, prepared for SARGENT Interchangeable 72- core cylinder - Right	
10-0577	"G" design, prepared for SARGENT Keso (82) cylinder - Left	
10-0578	"G" design, prepared for SARGENT Keso (82) cylinder - Right	

BL-40 BORED LOCKS

SARGENT®

7-LINE ASSEMBLIES

ASSA ABLOY

USA & Canada Prices Effective May 1, 2021

Lock Body Assemblies Standard Cylinder and non cylinder Functions		
Part #	Function	Price
07-2650	04	
* 07-2660	05	
07-2670	15	
07-2675	15-3	\$153.32
07-2680	37	
* 07-2690	65, 68 – order emergency release separately	
Lock Body Assemblies To Accept SARGENT Removable Core Cylinders (60-, 63-, 64-Options)		
Part #	Function	Price
07-2651	04	
* 07-2661	05	\$170.73
07-2681	37	
Lock Body Assemblies To Accept Arrow, Best, Falcon Interchangeable Cores		
Part #	Function	Price
07-2652	04	
* 07-2662	05	\$188.09
07-2682	37	
Lock Body Assemblies To Accept SARENT Keso (82-) Cylinders		
Part #	Function	Price
07-2653	04	
* 07-2663	05	\$169.88
07-2683	37	
FW-Lock Body Assemblies Standard Cylinder and non cylinder Functions		
Part #	Function	Price
07-2654	04	
* 07-2664	05	
07-2684	37	\$165.99
* 07-2691	65, 68	
FW-Lock Body Assemblies To Accept SARENT Removable Core Cylinders (60-, 63-, 64- Options)		
Part #	Function	Price
07-2655	04	
* 07-2665	05	\$180.97
07-2685	37	
FW-Lock Body Assemblies To Accept SARENT Interchangeable Core Cylinders (70-, 72-, 73- Options)		
Part #	Function	Price
07-2656	04	
* 07-2666	05	\$198.89
07-2686	37	
FW-Lock Body Assemblies To Accept SARENT Keso (82-) Cylinders		
Part #	Function	Price
07-2657	04	
* 07-2667	05	\$180.97
07-2687	37	

Experience a safer
and more open world

Copyright © 2002-2021 Sargent Manufacturing Company, an ASSA ABLOY Group company. All rights reserved.
Reproduction in whole or in part without the express written permission of Sargent Manufacturing Company is prohibited.
Contact us at: 800-727-5477 or visit www.sargentlock.com. In Canada contact us at: 800-461-3007 or visit www.assaabloydss.ca

7-LINE ROSES/LATCHES/PARTS

USA & Canada Prices Effective May 1, 2021

Roses		10BE/26D BSP/WSP	03/04/09/10/10B/ 10BL/14/15/20D/26
07-0111	Rose Scalp (all)	\$37.94	\$47.42
07-2428	Outside Rose Spring Assy. (15-3)	\$44.27	\$55.33
Latch Units		03/10/10B/ 10BE/32D/BSP/WSP	
Standard 2-3/4" Backset			
07-2430	Deadlocking Latch		\$35.03
07-2432	Latch		
20 Option 2-3/8" Backset		03/10/10B/ 10BE/32D/BSP/WSP	
07-2431	Deadlocking Latch		\$35.03
07-2433	Latch		
Miscellaneous Parts			
Part #	Description	Price	
01-0949	Washer only – for Schlage cylinder (30 option) (2 required per lock)	\$0.89	
01-4414	Screw Pan Head (#6-3/4"), (2 per lock) – surface screws	\$0.35	
07-0100	Spacer - Cardboard	\$0.74	
07-0102	I/S Support Plate (1-3/4" door)	\$6.75	
07-0105	O/S Support Plate (1-3/4" door)	\$6.75	
07-0112	Inside Rose Spring Assy. (94, 94-2)	\$33.12	
07-0113	Outside Rose Spring Assy. (93, 94, 94-2)	\$34.78	
07-2425	Inside Rose Spring Assy. (all except 94, 94-2)	\$50.59	
07-2426	Outside Rose Spring Assy. (all except 93, 94, 94-2, 15-3)	\$50.59	
07-2648	1-3/8" Door Mounting Kit (1 plate & 2 spacers) (1 & 20 option)	\$10.61	
07-2446	Thru-Bolt Mounting Pack (standard screw pack - hollow & long screw)	\$8.47	
* 07-2447	Dummy Thru-Bolt Mounting Pack (US3 or26D finish only)	\$5.04	
* 08-2842	Blank Front Assembly - 94-2 function	\$21.44	
10-0019	Cylinder Spacer - white plastic disk	\$0.71	
10-0032	Cylinder Retainer (Standard except IC, RC & KESO Cores)	\$1.66	
10-0043	Push pin tool	\$0.58	
10-0077	Lever catch spring	\$1.66	
10-0197	Lever Retainer	\$0.77	
10-0239	6-pin tailpiece (removable & interchangeable core)	\$2.05	
10-0240	7-pin tailpiece (interchangeable core)	\$1.91	
* 10-2052	Standard Screw Pack - all functions (for strike & front and surface screws)	\$4.99	
* 10-2070	Screwpack (28- option) - all functions (for strike & front and surface screws)	\$2.00	
10-2071	Screw pack (dummy trim 94 & 94-2 function)	\$1.66	
10-2090	Cylinder retainer & washer pack (30 option)	\$9.17	
10-3138	Cylinder tailpiece for 11- IC Core	\$6.58	

*Specify finish when ordering.

BL-42 BORED LOCKS

SARGENT®

6500

USA & Canada Prices
Effective May 1, 2021



KL shown

Rose Design:
K (Shown)

Lever Design:
B
L
P

ASSA ABLOY

Expect Longer Lead times (Approx 8 weeks): split finishes,
65G15-3, KB & KP trims.

Options	Description	Price
10	SARGENT Signature Key System	\$63.00 / cyl.
11	SARGENT XC Key System (not available with 10, 22, SC, SE options)	No addition
1160	Sargent XC Large Format Interchangeable Plastic Disposable Construction Core	No addition
1163	Sargent XC Large Format Interchangeable Core Cylinder - Includes masterkeying charges	\$83.00
1164	Sargent XC Large Format Interchangeable Construction Core Cylinder	\$83.00
1170	Small Format interchangeable disposable construction core - to accept 7 Pin XC permanent core	No addition
11727P	Small Format interchangeable keyed construction core - to accept 7 Pin XC permanent core	\$75.00
11737P	Small Format interchangeable core - to accept 7 pin XC permanent core	\$75.00 /cyl.
14	505 Full Lip Strike	No addition
20	2-3/8" Backset Latch – Fits 1-3/8" Door	No addition
21	SARGENT Construction Key System (lost ball) Standard on all new systems est. since 5/1/96	\$16.00 / cyl.
22	SARGENT Construction Key System (split key) To be used on pre-est. split key systems only	\$32.00 / cyl.
28	Lockset x ANSI A115.2 Strike #808 – 1-1/4" standard lip Lip Lengths 1-1/8" , or 1-3/8"	No addition
	Lip Lengths 1-5/8", 1-7/8", 2-1/8", 2-3/8", 2-5/8", 2-7/8"	\$11.00
60	SARGENT Large Format Interchangeable Plastic Disposable Construction Core	No addition
63	SARGENT Large Format Interchangeable Core Cylinder includes master and grandmaster keying charge	\$83.00 / cyl.
64	SARGENT Large Format Interchangeable Construction Core Cylinder	\$83.00
6573	Small Format 6 Pin Uncombined Interchangeable Core	\$65.00 / cyl.
65737P	Small Format 7 Pin Uncombined Interchangeable Core	\$65.00 / cyl.
70	Small Format Interchangeable disposable plastic construction core	No addition
72	Small Format Interchangeable 6 Pin Construction Core (7-Pin w/11- option)	See page CK-2
73	Small Format Interchangeable Core, 6-Pin Includes MK and GMK keying charges	\$75.00 / cyl.
737P	Small Format Interchangeable Core, 7-Pin Includes MK and GMK keying charges	\$75.00 / cyl.
85	Tactile Warning - Abrasive coating on inside lever	\$49.00
86	Tactile Warning - Abrasive coating on outside lever	\$49.00
87	Tactile Warning - Abrasive coating on both levers	\$98.00
BR	SARGENT Bump Resistant Cyls. (N/A w/10, 22, 30, 60, 63, 64, 70, 72, 73, 737P, KESO, SC, SE)	\$25.00 /cyl.
DG1	Patented Degree DG1 Key System	No addition
DG160	Hardware prepared for DG1-6300 Lg. Format IC cores, supplied with temporary plastic construction cores	No addition
DG163	Patented Degree DG1 Large Format Interchangeable Core Cylinder - Includes master keying charges	\$83.00
DG164	Hardware prepared for DG1-6300 Lg. Format IC cores, supplied with temporary keyed construction cores	\$83.00
DG2	Patented Degree DG2 Key System incorporating a locking sidebar	\$63.00/cyl.
DG260	Hardware prepared for DG2-6300 Lg. Format IC cores, supplied with temporary plastic construction cores	No addition
DG263	Patented Degree DG2 Large Format Interchangeable Core Cylinder - Includes master keying charges	\$146.00
DG264	Hardware prepared for DG2-6300 Lg. Format IC cores, supplied with temporary keyed construction cores	\$83.00
DG3	Patented Degree DG3 Key System incorporating a locking sidebar and UL437 listed	\$89.00/cyl.
DG360	Hardware prepared for DG3-6300 Lg. Format IC cores, supplied with temporary plastic construction cores	No addition
DG363	Patented Degree DG3 Large Format Interchangeable Core Cylinder - Includes master keying charges	\$172.00
DG364	Hardware prepared for DG3-6300 Lg. Format IC cores, supplied with temporary keyed construction cores	\$83.00
LC	Less Cylinder	-\$94.00/cyl.
SC	Schlage C keyway cylinder, O-bitted	No addition
SE	Schlage E keyway cylinder, O-bitted	No addition

Function Cylinder		Finish 10BE/26D	Finish 03/04/10/10B/26
65G04	Storeroom		
65G05	Office	\$309.00	\$311.00
65G37	Classroom		

Non Keyed			
65U15	Passage	\$214.00	\$216.00
65G15-3	Exit or Twin Communicating	\$243.00	\$245.00
65U65	Privacy	\$243.00	\$245.00
65U93	Single Lever Pull	\$98.00	\$99.00
65U94	Double Lever Pull	\$190.00	\$192.00

NOTE: Split finishes are available, price as higher finish. Order outside/inside and handing must be specified. Strike and latch front will match inside finish for RH/LH and outside finish for RHR/LHR.

Latchbolts			10B/10BE/32/32D
05-2182	Guarded	(Standard 2-3/4" Backset)	\$41.19
05-2183	Unguarded	(Standard 2-3/4" Backset)	\$35.67
05-2184	Guarded	(20 Option 2-3/8" Backset)	\$40.01
05-2185	Unguarded	(20 Option 2-3/8" Backset)	\$35.67

Strikes		Specify Finish
808	ANSI A115.2 – 4-7/8" Strike (Option 28-)Lip Lengths available: 1-1/8", 1-1/4" (Standard), 1-3/8", 1-5/8", 1-7/8", 2-1/8", 2-3/8", 2-5/8", 2-7/8"	Refer to page BL-53
505	Full Lip Strike	\$18.10
77-1141	Strike Box – for 808 Strike	\$12.00
05-3124	Cylinder tailpiece for 11- IC core	\$10.56

Experience a safer
and more open world

Copyright © 2002-2021 Sargent Manufacturing Company, an ASSA ABLOY Group company. All rights reserved.
Reproduction in whole or in part without the express written permission of Sargent Manufacturing Company is prohibited.
Contact us at: 800-727-5477 or visit www.sargentlock.com. In Canada contact us at: 800-461-3007 or visit www.assaabloydss.ca

DL SERIES – STANDARD LEVERS

USA & Canada Prices Effective May 1, 2021



TOL

Rose: TO, CO, O, E2
TR•, CR•, LN•, E3•
Lever: A*, B, E, F, J, L, P, W

How to order: 28-DLU65 x TOL x 26D
Option: 28
Function: DLU65
Rose: TO
Lever: L
Finish: 26D

*Specify hand when ordering

•Roses available with DLU93 & DLU94 functions only

Options	Description	Price
12	3 Hour UL Latch	Add \$6.00
13	Lockset x Front & Strike with 1/4" Radius and 2-3/8" Backset	No addition
14	505 Full Lip Strike	No addition
20	2-3/8" backset latch with 1" front	No addition
28	Lockset x ANSI A-156.115 Strike – 1-1/4" Lip Standard	No addition
	Lip Lengths 1-1/8" or 1-3/8"	No addition
	Lip Lengths 1-5/8", 1-7/8", 2-1/8", 2-3/8", 2-5/8", 2-7/8"	\$14.00
31	1-7/8" to 2" thick door – only centered in door	No addition
SG	MicroShield® an antimicrobial powder coat	\$73.00
TB	Through-bolting (for DLU93 function only)	Add \$29.00
WBS	Wrought Box Strike	No Addition

Non-Keyed Functions		10BE/26D BSP/WSP	03/04/09/10/10B/10BL/ 14/15/20D/26/32/32D
DLU15	Passage	\$243.00	\$253.00
DLU15-3	Exit or Twin Communicating	\$243.00	\$253.00
DLU65	Privacy	\$259.00	\$269.00
* DLU93	Single Lever Pull	\$107.00	\$112.00
** DLU94	Double Lever Pull	\$203.00	\$213.00

* DLU93 is only available with TB option

** DLU94 is not available with any above options

Latchbolts	Description	10BE/26D/BSP/WSP
DL-2000	Latch - 2 3/8" backset (15 function)	\$33.86
DL-2001	Latch - 2 3/4" backset (15 function)	\$33.86
DL-2002	Latch - 2 3/8" backset (65 function)	\$33.86
DL-2003	Latch - 2 3/4" backset (65 function)	\$33.86

Part#	Description	Price
82-1038	Set Screw	\$2.08

BL-44 BORED LOCKS

SARGENT®

DL COASTAL SERIES

ASSA ABLOY

USA & Canada Prices Effective May 1, 2021



TOY

Rose: TO, CO, O, E2
TR•, CR•, LN•, E3•
Lever: G*, R, S*, Y*

How to order: 28-DLU65 x TOC x 26D
Option: 28
Function: DLU65
Rose: TO
Lever: C
Finish: 26D

***Specify hand when ordering**

•Roses available with DLU93 & DLU94 functions only

Options	Description	Price
12	3 Hour UL Latch	\$6.00
13	Lockset x Front & Strike with 1/4" Radius and 2-3/8" Backset	No Addition
14	505 Full Lip Strike	No addition
20	2-3/8" backset latch with 1" front	No addition
28	Lockset x ANSI A-156.115 Strike – 1-1/4" Lip Standard	No addition
	Lip Lengths 1-1/8" or 1-3/8"	No addition
	Lip Lengths 1-5/8", 1-7/8", 2-1/8", 2-3/8", 2-5/8", 2-7/8"	\$14.00
31	1-7/8" to 2" thick door – only centered in door	No addition
SG	MicroShield® an antimicrobial powder coat	\$73.00
TB	Through-bolting (for DLU93 function only)	\$29.00
WBS	Wrought Box Strike	No Addition

Non-Keyed Functions		10BE/26D BSP/WSP	03/04/09/10/10B/ 10BL/14/15/20D/26
DLU15	Passage	\$243.00	\$253.00
DLU15-3	Exit or Twin Communicating	\$243.00	\$253.00
DLU65	Privacy	\$259.00	\$269.00
* DLU93	Single Lever Pull	\$107.00	\$112.00
** DLU94	Double Lever Pull	\$203.00	\$213.00

* DLU93 is only available with TB option

** DLU94 is not available with any above options

Experience a safer
and more open world

Copyright © 2002-2021 Sargent Manufacturing Company, an ASSA ABLOY Group company. All rights reserved.
Reproduction in whole or in part without the express written permission of Sargent Manufacturing Company is prohibited.
Contact us at: 800-727-5477 or visit www.sargentlock.com. In Canada contact us at: 800-461-3007 or visit www.assaabloydss.ca

USA & Canada Prices Effective May 1, 2021



TOMC



COMN



OMH

Rose: TO, CO, O, E2
TR, CR, LN, E3 – available with DLU93 & DLU94 functions only.

How to order: 28-DLU65 x TOMC x 26D

Option: 28

Studio Collection Levers (except Gramercy, Grant Park, Wooster Square Series)

Function: DLU65

***Specify hand when ordering.**

Rose: TO

– Following levers not available in 32 & 32D: MA, MC, MH, MK, MM, MN, MO, MP, MQ, MS, MT, MU, MV, MX, MY, MZ, NS, NU

Lever: MC

Finish: 26D

Options	Description	Price
12	3 Hour UL Latch	\$6.00
13	Lockset x Front & Strike with 1/4" Radius and 2-3/8" Backset	No Addition
14	505 Full Lip Strike	No addition
20	2-3/8" backset latch with 1" front	No addition
28	Lockset x ANSI A-156.115 Strike – 1-1/4" Lip Standard	No addition
	Lip Lengths 1-1/8" or 1-3/8"	No addition
	Lip Lengths 1-5/8", 1-7/8", 2-1/8", 2-3/8", 2-5/8", 2-7/8"	\$14.00
31	1-7/8" to 2" thick door – only centered in door	No addition
SG	MicroShield® an antimicrobial powder coat	\$73.00
TB	Through-bolting (for DLU93 function only)	\$29.00
WBS	Wrought Box Strike	No Addition

Non-Keyed Functions		10BE/26D BSP/WSP	03/04/09/10/10B/10BL/ 14/15/20D/26/32/32D
DLU15	Passage	\$243.00	\$253.00
DLU15-3	Exit or Twin Communicating	\$243.00	\$253.00
DLU65	Privacy	\$259.00	\$269.00
* DLU93	Single Lever Pull	\$107.00	\$112.00
** DLU94	Double Lever Pull	\$203.00	\$213.00

* DLU93 is only available with TB option

** DLU94 is not available with any above options

BL-46 BORED LOCKS

SARGENT®

ASSA ABLOY

DL SERIES – STUDIO COLLECTION WOOSTER SQUARE

USA & Canada Prices Effective May 1, 2021



H001



H002

Rose: TO, CO, O, E2
TR, CR, LN, E3, E4 – available with DLU93 & DLU94 functions only.

Levers: H001, H002

***Specify hand when ordering.**

How to order: 28-DLU65 x E4H001 x 26D

Option: 28

Function: DLU65

Rose: E4

Lever: H001

Finish: 26D

Options	Description	Price
12	3 Hour UL Latch	\$6.00
13	Lockset x Front & Strike with 1/4" Radius and 2-3/8" Backset	No Addition
14	505 Full Lip Strike	No addition
20	2-3/8" backset latch with 1" front	No addition
28	Lockset x ANSI A-156.115 Strike – 1-1/4" Lip Standard	No addition
	Lip Lengths 1-1/8" or 1-3/8"	No addition
	Lip Lengths 1-5/8", 1-7/8", 2-1/8", 2-3/8", 2-5/8", 2-7/8"	\$14.00
31	1-7/8" to 2" thick door – only centered in door	No addition
SG	MicroShield® an antimicrobial powder coat	\$73.00
TB	Through-bolting (for DLU93 function only)	\$29.00
WBS	Wrought Box Strike	No Addition

Non-Keyed Functions		10BE/26D BSP/WSP	03/04/09/10/10B/10BL/ 14/15/20D/26/32/32D
DLU15	Passage	\$254.00	\$264.00
DLU15-3	Exit or Twin Communicating	\$254.00	\$264.00
DLU65	Privacy	\$270.00	\$280.00
* DLU93	Single Lever Pull	\$116.00	\$121.00
** DLU94	Double Lever Pull	\$214.00	\$224.00

* DLU93 is only available with TB option

** DLU94 is not available with any above options

Experience a safer
and more open world

Copyright © 2002-2021 Sargent Manufacturing Company, an ASSA ABLOY Group company. All rights reserved.
Reproduction in whole or in part without the express written permission of Sargent Manufacturing Company is prohibited.
Contact us at: 800-727-5477 or visit www.sargentlock.com. In Canada contact us at: 800-461-3007 or visit www.assaabloydss.ca

DL STUDIO COLLECTION WOOSTER SQUARE & GRANT PARK

USA & Canada Prices Effective May 1, 2021



H004



H005

Rose: TO, CO, O, E2
TR, CR, LN, E3, E4 – available with DLU93 & DLU94 functions only.

Levers: H003, H004, H005, H006, H007, *▲H008, ▲H009, H010, ▲H011

* **Handed – Specify hand when ordering.**

▲ **Levers not available with DLU65 function.**

How to order: 28-DLU65 x E4H004 x 26D

Option: 28

Function: DLU65

Rose: E4

Lever: H003

Finish: 26D

Options	Description	Price
12	3 Hour UL Latch	\$6.00
13	Lockset x Front & Strike with 1/4" Radius and 2-3/8" Backset	No Addition
14	505 Full Lip Strike	No addition
20	2-3/8" backset latch with 1" front	No addition
28	Lockset x ANSI A-156.115 Strike – 1-1/4" Lip Standard	No addition
	Lip Lengths 1-1/8" or 1-3/8"	No addition
	Lip Lengths 1-5/8", 1-7/8", 2-1/8", 2-3/8", 2-5/8", 2-7/8"	\$14.00
31	1-7/8" to 2" thick door – only centered in door	No addition
SG	MicroShield® an antimicrobial powder coat	\$73.00
TB	Through-bolting (for DLU93 function only)	\$29.00
WBS	Wrought Box Strike	No Addition

Non-Keyed Functions		10BE/26D BSP/WSP	03/04/09/10/10B/10BL/ 14/15/20D/26/32/32D
DLU15	Passage	\$336.00	\$346.00
DLU15-3	Exit or Twin Communicating	\$336.00	\$346.00
DLU65	Privacy	\$350.00	\$360.00
* DLU93	Single Lever Pull	\$199.00	\$204.00
** DLU94	Double Lever Pull	\$297.00	\$307.00

* DLU93 is only available with TB option

** DLU94 is not available with any above options

BL-48 BORED LOCKS

SARGENT®

DL SERIES – STUDIO COLLECTION GRAMERCY SERIES

ASSA ABLOY

USA & Canada Prices Effective May 1, 2021

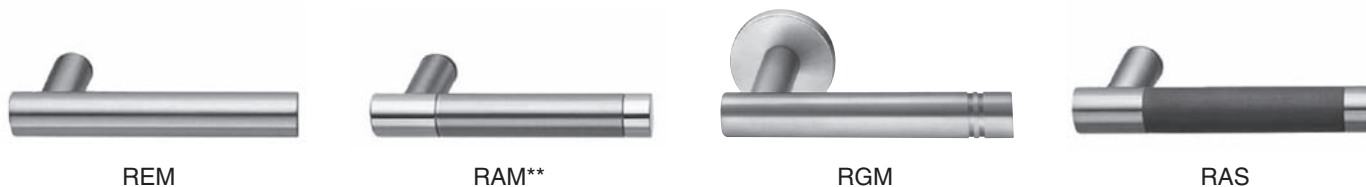

Rose Design:	Lever Design:	How to order Gramercy Series Levers:
CO	REM	Option: <u>14</u> x Function: <u>DLU15</u> x Rose: <u>O</u> x Lever: <u>RAS</u> x Finish: <u>29BK29</u> x Hand: <u>RH</u>
O	RAM	See below for available finishes:
TO	RAS	Lever Design Available Finishes
E2	RGM	REM-RGM 2929 or 3030
TR*		RAM 2930*
CR*		RAS 29BK29, 30BK30
LN*		*Two-tone - grip of lever is 32D, balance of lever is 32. Rose/escutcheon and lock finish will be 32.
E3*		See catalog for finish description.
•Roses available with DLU93 & DLU94 functions only		**RAM is not available in 10BE/BSP/WSP finish.

Options	Description	Price
12	3 Hour UL Latch	\$6.00
13	Lockset x Front & Strike with 1/4" Radius and 2-3/8" Backset	No Addition
14	505 Full Lip Strike	No addition
20	2-3/8" backset latch with 1" front	No addition
28	Lockset x ANSI A-156.115 Strike – 1-1/4" Lip Standard	No addition
	Lip Lengths 1-1/8" or 1-3/8"	No addition
	Lip Lengths 1-5/8", 1-7/8", 2-1/8", 2-3/8", 2-5/8", 2-7/8"	\$14.00
31	1-7/8" to 2" thick door – only centered in door	No addition
SG	MicroShield® an antimicrobial powder coat	\$73.00
TB	Through-bolting (for DLU93 function only)	\$29.00
WBS	Wrought Box Strike	No Addition

Non-Keyed Functions		10BE/BSP/WSP/629/630
DLU15	Passage	\$264.00
DLU15-3	Exit or Twin Communicating	\$264.00
DLU65	Privacy	\$280.00
* DLU93	Single Lever Pull	\$121.00
** DLU94	Double Lever Pull	\$224.00

* DLU93 is only available with TB option

** DLU94 is not available with any above options.

Experience a safer
and more open world

Copyright © 2002-2021 Sargent Manufacturing Company, an ASSA ABLOY Group company. All rights reserved.
Reproduction in whole or in part without the express written permission of Sargent Manufacturing Company is prohibited.
Contact us at: 800-727-5477 or visit www.sargentlock.com. In Canada contact us at: 800-461-3007 or visit www.assaabloydss.ca

DL SERIES – STUDIO COLLECTION GRAMERCY SERIES

USA & Canada Prices Effective May 1, 2021



RAL



RAG



RCM

Rose Design:

CO
O
TO
E2
TR•
CR•
LN•
E3•

Lever Design:

RAL
RAG
RCM

How to order Gramercy Series Levers:

Option: 28 x Function: DLU15-3 x Rose: TO x Lever: RAL x Finish: 30BN30 x Hand: RH

See below for available finish:

Lever Design Available Finishes

RAL	29BK29, 29BN29, 30BK30, or 30BN30
RAG	2929 or 3030
RCM	2929, 3030, or 2930*

See catalog for finish description.

•Roses available with DLU93 & DLU94 functions only

Options	Description	Price
12	3 Hour UL Latch	\$6.00
13	Lockset x Front & Strike with 1/4" Radius and 2-3/8" Backset	No Addition
14	505 Full Lip Strike	No addition
20	2-3/8" backset latch with 1" front	No addition
28	Lockset x ANSI A-156.115 Strike – 1-1/4" Lip Standard	No addition
	Lip Lengths 1-1/8" or 1-3/8"	No addition
	Lip Lengths 1-5/8", 1-7/8", 2-1/8", 2-3/8", 2-5/8", 2-7/8"	\$14.00
31	1-7/8" to 2" thick door – only centered in door	No addition
SG	MicroShield® an antimicrobial powder coat	\$73.00
TB	Through-bolting (for DLU93 function only)	\$29.00
WBS	Wrought Box Strike	No Addition

Non-Keyed Functions		10BE/BSP/WSP/629/630
DLU15	Passage	\$346.00
DLU15-3	Exit or Twin Communicating	\$346.00
DLU65	Privacy	\$360.00
* DLU93	Single Lever Pull	\$204.00
** DLU94	Double Lever Pull	\$307.00

* DLU93 is only available with TB option

** DLU94 is not available with any above options.

BL-50 BORED LOCKS

SARGENT®

SIMPLI™ ROSELESS TRIM RDL SERIES COASTAL SERIES

ASSA ABLOY

USA & Canada Prices Effective May 1, 2021

Lever: G*, R, S*, Y*



RY

Collar: R

Lever: Y

*Specify hand when ordering

How to order: 28-RDLU65 x R** Y x RH x 26D

Option: 28

Function: RDLU65

Rose: R**

Lever: Y

Hand: RH

Finish: 26D

**Specify "R" for Bored Locks compatible with roseless collar.

Options	Description	Price
1-	For doors 1-3/8" (35mm) thick	No addition
▲ 13	Lockset x Front & Strike with 1/4" Radius and 2-3/8" Backset	No addition
▲ 14	505 Full Lip Strike	No addition
▲ 20	2-3/8" backset latch with 1" front	No addition
▲ 28	Lockset x ANSI A-156.115 Strike – 1-1/4" Lip Standard	No addition
	Lip Lengths 1-1/8" or 1-3/8"	No addition
	Lip Lengths 1-5/8", 1-7/8", 2-1/8", 2-3/8", 2-5/8", 2-7/8"	\$14.00
SG	MicroShield® an antimicrobial powder coat (not available with 10B)	\$73.00
▲ WBS	Wrought Box Strike	No Addition

		10BE/26D	03/04/09/ 10/10B/10BL/ 14/15/20D/26
Non-Keyed Functions		BSP/WSP	
RDLU15	Passage	\$294.00	\$304.00
RDLU15-3	Exit or Twin Communicating	\$294.00	\$304.00
RDLU65	Privacy	\$313.00	\$323.00
RDLU93	Single Lever Pull	\$128.00	\$133.00
RDLU94	Double Lever Pull	\$242.00	\$252.00

▲ Options not available with RDLU93 and RDLU94 functions.

Experience a safer
and more open world

Copyright © 2002-2021 Sargent Manufacturing Company, an ASSA ABLOY Group company. All rights reserved.
Reproduction in whole or in part without the express written permission of Sargent Manufacturing Company is prohibited.
Contact us at: 800-727-5477 or visit www.sargentlock.com. In Canada contact us at: 800-461-3007 or visit www.assaabloydss.ca

SIMPLÍ™ ROSELESS TRIM RDL SERIES STUDIO COLLECTION LEVERS

USA & Canada Prices Effective May 1, 2021



RME

Collar: R
Lever: ME



RMI

Collar: R
Lever: MI



RMO

Collar: R
Lever: MO

Aventura Series: MB, ME, MF, MG, MI, MW, NF
 Centro Series: MD, MJ, ND, NJ
 Notting Hill Series: MQ*, MM*, MY*
 Odeon Series: MH*, MS*, MU*, MV*, MX*, NS*, NU*
 Rialto Series: MO, MZ*
 Following levers not available in 32 & 32D: MH, MM, MO,
 MQ, MS, MU, MV, MX, MY, MZ, NS, NU

How to order: 28-RDLU65 x R** MZ x LH x 26D
 Option: 28
 Function: RDLU65
 Rose: R**
 Lever: MZ
 Hand: LH
 Finish: 26D

***Specify hand when ordering**

****Specify "R" for Bored Locks compatible with roseless collar.**

Options	Description	Price
1-	For doors 1-3/8" (35mm) thick	No addition
▲ 13	Lockset x Front & Strike with 1/4" Radius and 2-3/8" Backset	No addition
▲ 14	505 Full Lip Strike	No addition
▲ 20	2-3/8" backset latch with 1" front	No addition
▲ 28	Lockset x ANSI A-156.115 Strike – 1-1/4" Lip Standard	No addition
	Lip Lengths 1-1/8" or 1-3/8"	No addition
	Lip Lengths 1-5/8", 1-7/8", 2-1/8", 2-3/8", 2-5/8", 2-7/8"	\$14.00
SG	MicroShield® an antimicrobial powder coat (not available with 10B)	\$73.00
▲ WBS	Wrought Box Strike	No Addition

Non-Keyed	Functions	03/04/09/10/10B/ 10BL/14/15/ 20D/26/32/32D	
		10BE/26D BSP/WSP	
RDLU15	Passage	\$294.00	\$304.00
RDLU15-3	Exit or Twin Communicating	\$294.00	\$304.00
RDLU65	Privacy	\$313.00	\$323.00
RDLU93	Single Lever Pull	\$128.00	\$133.00
RDLU94	Double Lever Pull	\$242.00	\$252.00

▲ Options not available with RDLU93 and RDLU94 functions.

BL-52 BORED LOCKS

SARGENT®

8X-LINE OPTIONS

ASSA ABLOY

USA & Canada Prices Effective May 1, 2021

Options	Description	Price
10	SARGENT Signature Key System	\$63.00 / cyl.
11	SARGENT XC Key System (not available with 10, 22, 30, SC, SE, KESO options)	No addition
21	SARGENT Construction Key System (lost ball) Standard on all new systems est. since 5/1/96	\$16.00 / cyl.
22	SARGENT Construction Key System (split key) To be used on pre-est. split key system only	\$32.00 / cyl.
28	Lockset x ANSI Strike – 1-1/4" Lip Standard	
	Lip Lengths 1-1/8" or 1-3/8"	\$5.00
	Lip Lengths 1-5/8", 1-7/8", 2-1/8", 2-3/8", 2-5/8", 2-7/8"	\$11.00
36	6 Lobe security head screws	\$15.00
37	Spanner head screws	\$15.00
DG1	Patented Degree DG1 Key System	No addition
DG2	Patented Degree DG2 Key System incorporating a locking sidebar	\$63.00/cyl.
DG3	Patented Degree DG3 Key System incorporating a locking sidebar and UL437 listed	\$89.00/cyl.
LC	Less Cylinder	-\$94.00/cyl.
WBS	Wrought Box Strike	No Addition

Experience a safer
and more open world

Copyright © 2002-2021 Sargent Manufacturing Company, an ASSA ABLOY Group company. All rights reserved.
Reproduction in whole or in part without the express written permission of Sargent Manufacturing Company is prohibited.
Contact us at: 800-727-5477 or visit www.sargentlock.com. In Canada contact us at: 800-461-3007 or visit www.assaabloydss.ca

USA & Canada Prices Effective May 1, 2021

L - Rose - 3-1/8" Dia.
B - Knob - 2-1/4" Dia.



Function		
Single Cylinder		03/10BE/32D
8XG04	Storeroom	
8XG05	Office	\$820.00
8XG37	Classroom	
Double Cylinder		
8XG17	Asylum	\$893.00
Non Keyed		
8XU15	Passage	\$660.00
8XU65	Privacy	\$741.00
8XU93	Dummy Trim	\$284.00
Strikes- Ordered Separate		03/04/10/10B/10BE/10BL 20D/32/32D/BSP/WSP
Number	Description	
800	ANSI T Strike Curved Lip	
	Furnished with Lip Length 1-1/4" standard	\$27.00
	Lip Lengths 1"	\$37.00
	Lip Lengths 1-1/2", 1-3/4", 2"	\$49.00
808	ANSI Strike Curved Lip	
	With 1-1/4" Lip C to E Standard	\$37.00
	Lip Lengths 1-1/8", 1-3/8"	\$49.00
	Lip Lengths 1-5/8", 1-7/8", 2-1/8", 2-3/8", 2-5/8", 2-7/8"	\$57.00
AM-0044	Strike box – 800 strike	\$12.00
77-1141	Strike box – 808 strike	\$12.00
Please Note: Specifying lip lengths other than listed above requires extra cost and lead times. Refer to Option pages for appropriate Add if ordered with lockset.		
Miscellaneous		
Number	Description	03/10BE/32D
08-5285	Screw Pack (includes 2 strikes, 2 latchbolts and 2 through-bolt screws)	\$13.00

BL-54 BORED LOCKS

SARGENT®

ASSA ABLOY

6-LINE OPTIONS

USA & Canada Prices Effective May 1, 2021

Options	Variations	Price
10▲	SARGENT Signature Key System	\$63.00 / cyl.
11▲	SARGENT XC Key System (not available with 10, 22, SC, SE options)	No addition
13	Lockset x Front & Strike 2-1/4" with 1/4" Radius (2-3/8" Backset Only)	No addition
14	1/4" radius full lip strike	No addition
15	Drive-In Guarded latchbolt (2-3/8" Backset Only)	No addition
17	Lockset x 2-3/4" Backset x 2-1/4" x 1" Front	\$3.00
21▲	SARGENT Construction Key System (lost ball) Standard on all new systems est. since 5/1/96	\$16.00 / cyl.
22▲	SARGENT Construction Key System (split key) To be used on pre-est. split key systems only	\$32.00 / cyl.
23	Lockset x 3-3/4" Backset x 2-1/4" x 1-1/8" Front	\$10.00
24	Lockset x 2-3/4" Backset x 2-1/4" x 1-1/8" Front	No addition
28	Lockset x ANSI A-156.115 Strike - #808 – 1-1/4" Lip Standard	
	Lip Lengths 1-1/8", or 1-3/8"	No addition
	Lip Lengths 1-5/8", 1-7/8", 2-1/8", 2-3/8", 2-5/8", 2-7/8"	\$11.00
36	6 Lobe security head screws	\$15.00
37	Spanner head screws	\$10.00
BR	SARGENT Bump Resistant Cyls. (N/A w/10, 22, 30, 70, 72, 73, 737P, KESO, SC, SE)	\$25.00 /cyl.
LC	Less Cylinder	-\$94.00/cyl.
SC	Schlage C Keyway Cylinder, 0-bitted	No addition
SE	Schlage E Keyway Cylinder, 0-bitted	No addition
SG	MicroShield® – an antimicrobial powder coat	\$73.00
WBS	Wrought Box Strike	No Addition

▲ Options not available for 50 function

6-LINE – KNOB DESIGN

USA & Canada Prices Effective May 1, 2021



<u>Function</u>		O, B - Rose / B, S, Knob Finish	
Single Cylinder		10BE/26D	03/04/10/10B/26
6G04	Storeroom		
6G05	Office	\$303.00	\$308.00
6G37	Classroom		
6G24	Dormitory		
6G38-2	Twin Communicating	\$359.00	\$365.00
6G50	Hotel		
Non Keyed			
6U15	Passage	\$194.00	\$205.00
6G15	Passage		
6G15-3	Exit	\$220.00	\$229.00
6U65	Privacy		
6G75-2	Twin Communicating	\$224.00	\$237.00
6U93	Single Knob Pull	\$94.00	\$97.00
6U94	Double Knob Pull	\$188.00	\$200.00

NOTE: Split finishes are available, price as higher finish. Order outside/inside and handing must be specified. Strike and latch front will match inside finish for RH/LH and outside finish for RHR/LHR.

<u>Strikes</u>			
Number	Description		
800	ANSI Strike Curved Lip Furnished with Lip Length 1-1/4" Standard Lip Lengths 1" Lip Lengths 1-1/2", 1-3/4", 2"	Refer to page BL-53	
808	ANSI Curved Lip (28- Option) Lip Length 1-1/4" Standard Lip Lengths 1-1/8" or 1-3/8" Lip Lengths 1-5/8", 1-7/8", 2-1/8", 2-5/8", 2-7/8"	Refer to page BL-53	
AM-0044	Strike box – standard	\$12.00	
77-1141	Strike box – 808 strike	\$12.00	
Number	Description	10BE/32D	03/04/10/10B/32
506	Full Lip Strike (14 Option)	\$18.00	\$21.00

* Handed – please specify hand when ordering.

BL-56 BORED LOCKS

SARGENT®

6-LINE LATCHES/DOOR KIT

ASSA ABLOY

USA & Canada Prices Effective May 1, 2021

Latch Tubes		Specify Finish	
Standard 2 - 3/8" Backset x 2 - 1/4" x 1" Front		03/10/10B/10BE/32D	
06-5083	Guarded		\$44.36
06-5225	Unguarded		\$36.66
13 Option - 2 - 3/8" Backset x 2 - 1/4" x 1" x 1/4" Radius Front		03/10/10B/10BE/32D	
06-5085	Guarded		\$44.36
06-5227	Unguarded		\$36.66
15- Option - Drive - in 2-3/8" Backset		32D	
06-5100	Guarded		\$44.36
17 Option - 2 - 3/4" Backset x 2 - 1/4" x 1" Front		03/10/10B/10BE/32D	
06-5102	Guarded		\$49.88
06-5234	Unguarded		\$42.16
23 Option - 3 - 3/4" Backset x 2 - 1/4" x 1 - 1/8" Front		03/10/10B/10BE/32D	
06-5096	Guarded		\$49.88
06-5232	Unguarded		\$42.16
24 Option - 2 - 3/4" Backset x 2 - 1/4" x 1 - 1/8" Front		03/10/10B/10BE/32D	
06-5094	Guarded		\$44.36
06-5231	Unguarded		\$36.66
Latch Tube Sleeve			
06-0578			\$3.68
Miscellaneous		10BE/26D	03/10/10B/26
530	Rabbeted Door Kit	\$66.00	\$78.00

Experience a safer
and more open world

Copyright © 2002-2021 Sargent Manufacturing Company, an ASSA ABLOY Group company. All rights reserved.
Reproduction in whole or in part without the express written permission of Sargent Manufacturing Company is prohibited.
Contact us at: 800-727-5477 or visit www.sargentlock.com. In Canada contact us at: 800-461-3007 or visit www.assaabloydss.ca

USA & Canada Prices Effective May 1, 2021

Note: All parts listed below are for product manufacturing after January, 2003

<u>Part No.</u>		<u>Price</u>
AM-0044	Strike Box (Standard)	\$12.00
01-1156	Mounting Screw	\$0.79
.01-1168	Mounting Screw	\$0.74
.01-1169	Mounting Screw	\$1.21
*01-5000	Mounting Screw	\$0.89
*06-0500	Cylinder Knob "B" O/S + I/S	\$35.96
*06-0501	Button Knob "B" O/S + I/S	\$35.96
*06-0502	Plain Knob "B" O/S + I/S	\$35.96
*06-0503	Cylinder Knob "S" O/S + I/S	\$35.96
*06-0504	Button Knob "S" O/S + I/S	\$35.96
*06-0505	Plain Knob "S" O/S + I/S	\$35.96
*06-0512	Knob Collar "B"	\$7.71
.06-0525	Knob Catch Stop	\$3.87
*06-0528	Knob Collar "S"	\$7.71
*06-2675	Screw Pack (Except 75-2, 93, 94)	\$5.89
.06-5003	Mtg. Plate (B+O Rose)	\$9.17
*06-5005	Outside Rose "B"	\$23.85
*06-5006	Outside Rose "O"	\$23.85
*06-5011	Lockbody (B, S-Knob) 15	\$148.56
*06-5012	Lockbody (S-Knob) 05	\$148.56
*06-5013	Lockbody (S-Knob) 24	\$148.56
*06-5016	Lockbody (S-Knob) 04	\$148.56
*06-5017	Lockbody (B, S-Knob) 15-3	\$148.56

<u>Part No.</u>		<u>Price</u>
*06-5018	Lockbody (S-Knob) 38-2	\$148.56
*06-5019	Lockbody (S-Knob) 65	\$148.56
*06-5020	Lockbody (S-Knob) 75-2	\$148.56
*06-5040	Lockbody (B-Knob) 05	\$133.88
*06-5041	Lockbody (B-Knob) 24	\$133.88
*06-5043	Lockbody (B-Knob) 50	\$133.88
*06-5044	Lockbody (B-Knob) 65	\$133.88
*06-5045	Lockbody (B-Knob) 75-2	\$133.88
*06-5054	Blank Rose "B" (15-3 function)	\$18.35
.06-5056	Lockset Screw Pack (Standard)	\$4.76
.06-5057	Turn Knob Assembly Screw Pack	\$7.71
*06-5058	Dummy Trim Lg Rose Screw Pk	\$2.01
.06-5059	Dummy Trim Reg Rose Screw Pk	\$2.01
.06-5069	Mounting Plate "E, L"	\$45.85
*06-5129	Inside "O" Rose Assy	\$23.85
*06-5130	Inside "B" Rose Assy	\$23.85
06-5147	Pin Asy. - Rem. Core	\$30.30
*06-5215	Lockbody (S-Knob) 37	\$148.55
*06-5240	Lockbody (B-Knob) 37	\$133.88
*06-5241	Lockbody (B-Knob) 38-2	\$133.88
*06-5349	Turn Button Assembly	\$2.29
14-0299	Lock-Out Key (50 function)	\$5.48
14-0300	Emergency Key (65 function only)	\$0.55

Note: Rose designs "B" and "O" are not interchangeable with "E" and "L" designs. They require different lock bodies.

*Specify hardware finish required. Consult catalog for available finishes

USA & Canada Prices Effective May 1, 2021

MORTISE LOCKS 7800/8200

How to Order/ANSI Finish & Function Comparison	ML-1
Indicators and Directional Engraving	ML-2
Retrofit Kits/Trim.....	ML-3

8200-Line

Options	ML-4
8200: Rose x A, E, F, W Lever	ML-5
Options	ML-6
NAC 8200: Rose x A, E, F, W Lever	ML-7
Options	ML-8
8200: Rose x B, L, P Levers	ML-9
Options	ML-10
NAC 8200: Rose x B, L, P Levers	ML-11
Options	ML-12
8200: Rose x J Lever	ML-13
Options	ML-14
NAC 8200: Rose x J Lever	ML-15
Options	ML-16
8200: LE1, LE2, LE3, LE4	
Escutcheon x A, B, E, F, J, L, P, W Levers	ML-17
Options	ML-18
NAC 8200: LE1, LE2, LE3, LE4	
Escutcheon x A, B, E, F, J, L, P, W Levers	ML-19
Options	ML-20
8200: LW1 Escutcheon x A, B, E, F, J, L, P, W Levers	ML-21
Options	ML-22
NAC 8200: LW1	
Escutcheon x A, B, E, F, J, L, P, W Levers	ML-23
Options	ML-24
8200: WT Escutcheon x A, B, E, F, J, L, P, W Lever	ML-25
Options	ML-26
NAC 8200: WT	
Escutcheon x A, B, E, F, J, L, P, W Lever	ML-27
Options	ML-28
8200: LS Escutcheon x A, B, E, F, J, L, P, W Levers	ML-29
8200 Freewheeling Options	ML-30
8200: Freewheeling FE	
Escutcheon x A, B, E, F, J, L, P, W Levers	ML-31
Options	ML-32
8200: Coastal Series Design - Rose x Lever	ML-33
Options	ML-34
NAC 8200: Coastal Series Design - Rose x Lever	ML-35
Options	ML-36
8200: Coastal Series Design - Escutcheon x Lever	ML-37
Options	ML-38
NAC 8200: Coastal Series Design - Escutcheon x Lever	ML-39
Options	ML-40
8200 Studio Collection	ML-41
Options	ML-42
8200 Studio Collection	ML-43
8200 Studio Collection Options.....	ML-44

8200 Studio Collection x Rose.....	ML-45
Options	ML-46
8200 Studio Collection	ML-47
8200 Studio Collection Options.....	ML-48
8200 Studio Collection x Rose.....	ML-49
8200 Studio Collection Options.....	ML-50
NAC 8200 Studio Collection x Rose	ML-51
8200 Studio Collection Options.....	ML-52
8200 Studio Collection x Rose.....	ML-53
8200 Studio Collection Options.....	ML-54
8200 Studio Collection x Escutcheon	ML-55
8200 Studio Collection Options.....	ML-56
8200 Studio Collection x Escutcheon	ML-57
8200 Studio Collection Options.....	ML-58
NAC 8200 Studio Collection x Escutcheon.....	ML-59
8200 Gramercy Series Options.....	ML-60
8200 Gramercy Series x Rose.....	ML-61
8200 Gramercy Series Options.....	ML-62
NAC 8200 Gramercy Series x Rose	ML-63
8200 Gramercy Series Options.....	ML-64
8200 Gramercy Series x Rose.....	ML-65
8200 Gramercy Series Options.....	ML-66
NAC 8200 Gramercy Series x Rose	ML-67
8200 Gramercy Series Options.....	ML-68
8200 Gramercy Series x Escutcheon	ML-69
8200 Gramercy Series Options.....	ML-70
NAC 8200 Gramercy Series x Escutcheon.....	ML-71
8200 Gramercy Series Options.....	ML-72
8200 Gramercy Series x Escutcheon	ML-73
8200 Gramercy Series Options.....	ML-74
NAC 8200 Gramercy Series x Escutcheon.....	ML-75
8200 Roseless – Coastal Series Options	ML-76
R8200: Coastal Series Design – Roseless Collar	ML-77
8200 Roseless – Studio Collection Options.....	ML-78
R8200 Studio Collection – Roseless Collar	ML-79
8200 Roseless – Studio Collection & Coastal Options	ML-80
NAC R8200 Studio Collection & Coastal – Roseless Collar.....	ML-81

7800-Line

Options	ML-82
7800: Rose x B, C Knob	ML-83
Options	ML-84
7800: KW1, KE1, KE2, KE3, KE4	
Escutcheon x B, C Knob	ML-85
Options	ML-86
7800: WT Escutcheon x B, C Knob	ML-87
Options	ML-88
7800: KS Escutcheon x K Knob.....	ML-89
Options	ML-90
7800: SL Rose x D Knob	ML-91
8200 Deadlocks.....	ML-92

USA & Canada Prices Effective May 1, 2021

Distributor Bulk Pack Trim Program

Features	ML-93
8200/7800 Distributor Bulk Pack - Lockbodies	ML-94
8200 Trim Packs	ML-95
8200 7800 Trim Packs	ML-96
7800/8200 Lockbodies	ML-97

7800/8200 Working Trim Sets

8200 Trim Set Program Features	ML-98
8200 Inside Trim Set.....	ML-99
8200 Inside Trim Set.....	ML-100
8200 Inside trim Set	ML-101
8200 Inside Trim Set.....	ML-102
8200 Outside Trim Set	ML-103
8200 Outside Trim Set	ML-104
8200 Outside Trim Set.....	ML-105
7800 Inside Trim Set.....	ML-106
7800 Inside Trim Set.....	ML-107
7800 Outside Trim Set	ML-108
7800 Outside Trim Set	ML-109

7800/8200 Assemblies & Parts

8200 Levers.....	ML-110
8200 Levers.....	ML-111
8200 Milled Levers & 7800 Knobs	ML-112
8200/7800 Inside Escutcheons	ML-113
8200/7800 Inside Escutcheons	ML-114
8200/7800 Outside Escutcheons	ML-115
8200/7800 Outside Escutcheons	ML-116
7800/8200 Roses/Turns	ML-117
7800/8200 Mounting Kits	ML-118
8200 Strikes & 7700/8100 Spindles/Strikes.....	ML-119

8200/7800 Parts

01-0010 to 82-0009.....	ML-120
82-0017 to 82-3085.....	ML-121
82-3088 to 97-0478.....	ML-122

MORTISE LOCKS 7900

How to Order/ANSI Finish & Function Comparison	ML-123
--	--------

7900 Mortise Lock

7900 Series Lever Locks Options	ML-124
7900 Series Rose x Levers	ML-125
7900 Series LW1 Escutcheon Lever Locks Options.....	ML-126
7900 Series LW1 Escutcheon Lever Locks	ML-127
7900 Series WT Escutcheon Lever Locks Options	ML-128
7900 Series WT Escutcheon Lever Locks	ML-128
7900 Series WT Escutcheon Lever Locks Options	ML-130
7900 Series WT Escutcheon Lever Locks	ML-131
7900 Series WT Escutcheon Lever Locks Options	ML-132
7900 Series WT Escutcheon Lever Locks	ML-133
7900 Series Studio Collection Lever Locks Options.....	ML-134
7900 Series Studio Collection Lever Locks	ML-135

7900 Series Studio Collection Lever Locks Options.....	ML-136
7900 Series Studio Collection Lever Locks	ML-137
7900 Series Studio Collection Lever Locks Options.....	ML-138
7900 Series Studio Collection Lever Locks	ML-139
7900 Series Studio Collection Lever Locks Options.....	ML-140
7900 Series Studio Collection Lever Locks	ML-141
7900 Series Studio Collection Lever Locks Options.....	ML-142
7900 Series Studio Collection Lever Locks	ML-143
7900 Series Studio Collection Lever Locks Options.....	ML-144
7900 Series Studio Collection Lever Locks	ML-145
7900 Series Studio Collection Lever Locks Options	ML-146
7900 Series Studio Collection Lever Locks	ML-147
7900 Series Studio Collection Lever Locks Options	ML-148
7900 Series Studio Collection	ML-149

Escutcheon Lever Locks

7900 Series Knob Locks Options.....	ML-150
7900 Series Rose x B Knob.....	ML-151
7900 Series KW1 Escutcheon Knob Lock Options.....	ML-152
7900 Series KW1 Escutcheon Knob Lock	ML-153
7900 Series WT Escutcheon Knob Lock Options.....	ML-154
7900 Series WT Escutcheon Knob Lock	ML-155
7900 Series Lockbodies	ML-156

HIGH SECURITY MORTISE LOCK 9200

How to Order - ANSI Finish & Function	
Comparison 9200 and M9200 - Levers.....	ML-157

9200 and M9200 - Levers

Options-9200.....	ML-158
9200: LN, L, Rose x B, J, L, P Levers	ML-159
Options-9200.....	ML-160
9200: SN, SL, Rose x B, J, L, P Levers.....	ML-161
Options	ML-162
9200: LE3, LE4 Escutcheon x B, J, L, P Levers.....	ML-163
Options-9200.....	ML-164
9200: LS Escutcheon x B, J, L, P Levers	ML-165

9200 & M9200 - Knobs

Options-9200.....	ML-166
9200: SL, SN, Rose x K Knob	ML-167
Options-9200.....	ML-168
9200: LS Escutcheon x K Knob	ML-169
Options-9200.....	ML-170
9200: SL Rose x D Knob	ML-171
Options-9200 Rose BHD Knob	ML-172
9200: 9200 Rose BHD Knob.....	ML-173
Options-9200 Behavioral Health (BHW)	ML-174
9200 Behavioral Health (BHW)	ML-175
9200 Deadlock/Lock Bodies.....	ML-176
9200 Parts.....	ML-177
9200 Inside Trim Set.....	ML-178
9200 Outside Trim Set	ML-179

USA & Canada Prices Effective May 1, 2021

How to Order		
Step	Description	Example
Quantity	Each	10 Ea.
Option	Consult catalog for options available	10 Ea. 75-
Product Series	8200 Levers, 7800 Knobs	10 Ea. 75-82
Function	Consult catalog for functions available	10 Ea. 75-8205
Trim	Consult catalog for trims available	10 Ea. 75-8205 LNL
Finish	Consult catalog for finishes available	10 Ea. 75-8205 LNL US26D
Hand	Consult catalog for handing requirements	10 Ea. 75-8205 LNL US26D RH
Options	Consult factory for options available	10 Ea. 75-8205 LNL US26D RH x 1-3/8" Lip Strike
When ordering split finishes specify outside finish first		10 Ea. 75-8205 LNL US3 x US26D RH

To price split trim/finish, defaults to higher price.

Locksets in combinations not listed should be figured by adding together the prices of the component parts.

If by any method of figuring, lower prices can be obtained than set prices shown, set prices will prevail.

It is not permissible to take full deduction for omission of a component from a lockset.

Prices are for 1-3/4" door. For other door thicknesses not listed herein, please consult factory.

ANSI Finish and Function Comparison				
Function		Finish		
SARGENT	ANSI	SARGENT	ANSI	Description
15	F01	US3	605	Polished brass, clear coated
68	F02	US4	606	Satin brass, clear coated
05, 55	F04	US9	611	Polished bronze, clear coated
37	F05	US10	612	Satin Bronze, clear coated
89	F06	US10B	613	Oxidized Satin Bronze/Oil Rubbed
04	F07	US10BE	613E	Dark Oxidized Satin Bronze - Equivalent
47	F08/F10	US10BL	---	Oxidized Satin Bronze, clear coated
14		US14	618	Bright nickel, clear coated
16	F09	US15	619	Satin nickel, clear coated
46	F11	US20D	---	Statuary dark bronze, clear coated
45	F12	US26	625	Polished chrome
25	F13	US26D	626	Satin chrome
26	F14	US32	629	Polished stainless steel
50	F15	US32D	630	Satin stainless steel
22	F16	BSP	---	Black Suede Powder Coat
21	F17	WSP	---	White Suede Powder Coat
20	F18			
66	F19			
43	F20			
24	F21			
65	F22			
67	F26			
03	F29			
17	F30			
13	F31			
38	F32			
39	F33			
40	F34			
48	F35			

ML-2 MORTISE LOCKS

SARGENT®

ASSA ABLOY

INDICATORS AND DIRECTIONAL ENGRAVING

USA & Canada Prices Effective May 1, 2021 – Rev 11/26/20

Indicators and VN1 are not available in 629 or 630 finish.

Indicators and directional arrow engraving are available with the following 7800 and 8200 Series functions:

05, 20, 21, 22, 24, 25, 26, 28, 29, 30, 36, 37, 38, 39, 40, 41, 42, 43, 45, 46, 47, 50, 51, 52, 56,
57, 58, 59, 65, 66, 67, 68, NAC-PHR-82281, NAC-PHR-82285

Sectional indicators available with the following rose designs:

O, LN, E, TR, CR, CO, TO, E2 and E3

Escutcheon indicators functions only available with the following escutcheon design:

VN1

Escutcheon indicators not available with the following lever designs:

MK & MT
H001 – H011

To order indicators with complete locksets or retrofit kits/trim, specify indicator option code.

Directional engraving must be specified on all functions if required.

Please refer to the 7800/8200 Series catalog for more information.

Indicator Option Codes:

Options	Description	Price
V10	Single Indicator Outside - Unlocked/Locked - Green/Red	\$130.00
V20	Single Indicator Outside - Vacant/Occupied - Green/Red	\$130.00
V30	Single Indicator Outside - Icons Only - Green/Red	\$130.00
V40	Single Indicator Outside - Unlocked/Locked - White/Red	\$130.00
V50	Single Indicator Outside - Vacant/Occupied - White/Red	\$130.00
V60	Single Indicator Outside - Icons Only - White/Red	\$130.00
V01	Single Indicator Inside - Unlocked/Locked - Green/Red	\$130.00
V03	Single Indicator Inside - Icons Only - Green/Red	\$130.00
V04	Single Indicator Inside - Unlocked/Locked - White/Red	\$130.00
V06	Single Indicator Inside - Icons Only - White/Red	\$130.00
V11	Double Indicator - Unlocked/Locked - Green/Red (Outside) Unlocked/Locked - Green/Red (Inside)	\$260.00
V21	Double Indicator - Vacant/Occupied - Green/Red (Outside) Unlocked/Locked - Green/Red (Inside)	\$260.00
V33	Double Indicator - Icons Only - Green/Red (Outside) Icons Only - Green/Red (Inside)	\$260.00
V44	Double Indicator - Unlocked/Locked - White/Red (Outside) Unlocked/Locked - White/Red (Inside)	\$260.00
V54	Double Indicator - Vacant/Occupied - White/Red (Outside) Unlocked/Locked - White/Red (Inside)	\$260.00
V66	Double Indicator - Icons Only - White/Red (Outside) Icons Only - White/Red (Inside)	\$260.00
EMA*	Outside Engraving with "Lock" and Directional Arrow	\$48.00
EMB*	Inside Engraving with "Lock" and Directional Arrow	\$48.00
EMC*	Engraving Both Sides with "Lock" and Directional Arrow	\$96.00

*Engraving limited to the following finishes: 3, 4, 14, 15, 26, 26D.

Lock handing must be specified.

Experience a safer
and more open world

Copyright © 2002-2021 Sargent Manufacturing Company, an ASSA ABLOY Group company. All rights reserved.
Reproduction in whole or in part without the express written permission of Sargent Manufacturing Company is prohibited.
Contact us at: 800-727-5477 or visit www.sargentlock.com. In Canada contact us at: 800-461-3007 or visit www.assaabloydss.ca

Retrofit kits are available for existing applications.

Sectional Trim:

Each kit includes single side indicator plate with mechanism, screw pack, plastic template and instructions. To order retrofit kits, specify by model number. Door thickness, handing and indicator option code must also be specified with kit. Retrofit kits with directional engraving must include lock handing.

Sectional Trim Retrofit Kits for V Series Indicators:

Model#	Description	List Price
SA190	Keyed for use with the following functions: 20, 21, 22, 24, 25, 26, 28, 29, 30, 39, 40, 41, 43, 45, 46,47, 50, 51, 52, NAC-PHR-82281	
SA191	Keyed for use with the following functions: 36, 56, 57, 58, 67	
SA192	Keyed for use with the following functions: 05, 37, 38, 42, 59	
SA193	Cointurn for use with the following functions: 65, 66, 68	\$220.00
SA194	Thumbturn for use with the following functions: 21, 24, 25, 28, 43, 45, 47, 50, 51, 66, 68, NAC-PHR-82281, NAC-PHR-82285	
SA196	Thumbturn for use with the following functions: 56, 57, 58, 65, 67	
SA197	No Input - Blank for use with the following functions: 30, 37, NAC-PHR-82285	
SA198	Thumbturn for use with the following function: 05	

Note: When ordering sectional trim retrofit kits, specify finish, hand and V code required. i.e. SA190 x RH x 26D x V01

Cylinders not included. Kits accommodate indicators on one side of the door only. If indicators are required for both sides, 2 kits must be ordered as required by function.

Escutcheon Trim Set Kits

Retrofit kits are available as complete trim packs for existing applications. Trim pack includes levers and escutcheons with mechanism for both sides of door, screw pack, door marker and instructions.

Specify by adding option code IS to complete order string. Add for indicator option also applies.

i.e. IS-V04-8256 x VN1 x 1-3/4" x RH x 26D.

Note: Specifying IS option provides complete trim kit for inside and outside of the door ONLY when used with the VN1 escutcheon.

IS Used with VN1 Escutcheon	Trim Design	Finish	
		10BE/26D/BSP/WSP	03/04/09/10/10B/ 10BL/14/15/20D/26
All Functions	All Studio Except Gramercy	\$948.00	\$974.00
	A, B, E, F, J, L, P, W	\$948.00	\$974.00
	Knobs	\$1,016.00	\$1,042.00
	Trim Design	10BE/BSP/WSP	
	Gramercy Series (RAM-RAS-REM-RGM)	\$1,116.00	
	Gramercy Series (RAG-RAL-RCM)	\$1,203.00	

Indicator option add also applies.

ML-4 MORTISE LOCKS

For V Series
Indicators
Click / See
Page ML-1A

SARGENT®

ASSA ABLOY

OPTIONS

USA & Canada Prices Effective May 1, 2021

Options	Description	Price
1▲	8200 Line with 1-1/16" wide front for 1-3/8" doors.	\$62.00
3	Stainless steel hub (not available with 8289, 8291 & 8292 functions)	\$69.00
10▲	SARGENT Signature Key System	\$63.00 / cyl.
11†▲	SARGENT XC Key System (not available w/10, KESO, SC, SE)	No addition
1160	SARGENT XC Large Format Interchangeable Plastic Disposable Construction Core	No addition
1163	SARGENT XC Large Format Interchangeable Core Cylinder - Includes masterkeying charges	\$83.00
1164	SARGENT XC Large Format Interchangeable Construction Core Cylinder	\$83.00
1170	Small Format interchangeable disposable construction core - to accept 7 Pin XC permanent core	No addition
11727P	Small Format interchangeable keyed construction core - to accept 7 Pin XC permanent core	\$75.00
11737P	Small Format interchangeable core - to accept 7 pin XC permanent core	\$75.00 / cyl.
21▲†	SARGENT Construction Key System (lost ball) Standard on all new systems established since 5/1/96	\$16.00 / cyl.
22▲†	SARGENT Construction Key System (split key) To be used on pre-established split key systems only	\$32.00 / cyl.
23	Locksets with flat 4 7/8" ANSI strike	No addition
31	Thick Doors - Extended Lip Required - Specify Length C to E - Cylinders - IMPORTANT- See catalog 7800/8200 option page for cylinder limitations - Below charges DO NOT include additional charges for special cylinder requirements Doors up to 2-1/2" thick - lock centered Doors 2-5/8" to 6" thick OR doors 1-3/4" thick w/max 1" paneling one side. For example: Specify 1-3/4" door with panel (Side) on inside or outside	No addition Non Keyed function \$50.00 Keyed function \$100.00
36	6 Lobe security head screws	\$24.00
37	Spanner head screws	\$17.00
49	Visual Status Indicator - Available with 30, 36, 37 function - Rose Trims CR, E, L, LN, O, TR - Available with 26, 29, 38, 39 40, 41 functions - Rose Trim 8200 LN	\$140.00
49	Occupancy Indicator with emergency Release - Available with 65, 66, 68 functions; Rose Trims 7800 CR, E, L, LN, O, TR	\$140.00
50	Secured Indicator Rose- doors 1-5/8" to 2-1/4" thick- Avail.w/24,25,26,28,29,30,36,37,38,39,40,41,43,45,50,51,52,57,58,67 functions	\$140.00
60	SARGENT Large Format Interchangeable Plastic Disposable Construction Core	No addition
63	SARGENT Large Format Interchangeable core cylinder, includes master keying charges	\$83.00 / cyl
64	SARGENT Large Format Interchangeable Construction Core Cylinder	\$83.00
6573▲†	Small Format 6-Pin Uncombined Core (Refer to CK-12)	\$65.00 / cyl.
65737P▲†	Small Format 7-Pin Uncombined Core (Refer to CK-12)	\$65.00 / cyl.
68	8200 Line furnished with lever handle outside x knob inside (Excludes SLD Detention Knob)	Defaults to 8200 Lever Lock Price
69	8200 Line furnished with lever handle inside x knob outside (Excludes SLD Detention Knob)	Defaults to 8200 Lever Lock Price
70▲†	Small Format interchangeable disposable plastic construction core	No addition
72▲†	Small Format interchangeable 6-Pin construction core	\$75.00
73▲†	Small Format interchangeable core 6-pin Includes MK and GMK keying charges	\$75.00 / cyl
737P▲†	Small Format interchangeable core 7-pin (refer to CK-12 for available keyways) Includes MK and GMK keying charges	\$75.00 / cyl
74	Lock case wrapped in lead - handing required (roses not available)	\$294.00
75	Tactile Warning - Milled Inside Lever	\$78.00
76	Tactile Warning - Milled Outside Lever	\$78.00
77	Tactile Warning - Milled Outside and Inside Lever	\$156.00
81▲†	Cylinder to accept Keso (83) and Keso F1 (F183) removable core - no core provided	No addition
F182†	SARGENT Keso Security Cylinder - patented - new key systems	\$91.00 / cyl.
F183▲†	SARGENT Keso Security Removable Core Cylinder - patented - new key systems	\$130.00 / cyl.
82†	SARGENT Keso Security Cylinder (For existing systems only)	\$91.00 / cyl.
83▲†	SARGENT Keso Security Removable Core Cylinder (For existing systems only)	\$130.00 / cyl.
84▲†	SARGENT Keso Security Removable Construction Core Cylinder	See CK-18
85	Tactile Warning - Abrasive Coating on Inside Lever	\$49.00
86	Tactile Warning - Abrasive Coating on Outside Lever	\$49.00
87	Tactile Warning - Abrasive Coating on Outside & Inside Lever	\$98.00
AV	Anti Vandal Pull Trim (available in 32D finish), (Not available with 8270, 8271, 8272, 8273 functions)	\$229.00
BR	SARGENT Bump Resistant Cylinders (N/A w/10, 22, 30, 60, 63, 64, 70, 72, 73, 737P, KESO, SC, & SE options)	\$25.00 /cyl.
DG1	Patented Degree DG1 Key System	No addition
DG160	Hardware prepared for DG1-6300 Lg. Format IC cores, supplied with temporary plastic construction cores	No addition
DG163	Patented Degree DG1 Large Format Interchangeable Core Cylinder - Includes master keying charges	\$83.00
DG164	Hardware prepared for DG1-6300 Lg. Format IC cores, supplied with temporary keyed construction cores	\$83.00
DG2	Patented Degree DG2 Key System incorporating a locking sidebar	\$63.00/cyl.
DG260	Hardware prepared for DG2-6300 Lg. Format IC cores, supplied with temporary plastic construction cores	No addition
DG263	Patented Degree DG2 Large Format Interchangeable Core Cylinder - Includes master keying charges	\$146.00
DG264	Hardware prepared for DG2-6300 Lg. Format IC cores, supplied with temporary keyed construction cores	\$83.00
DG3	Patented Degree DG3 Key System incorporating a locking sidebar and UL437 listed	\$89.00/cyl.
DG360	Hardware prepared for DG3-6300 Lg. Format IC cores, supplied with temporary plastic construction cores	No addition
DG363	Patented Degree DG3 Large Format Interchangeable Core Cylinder - Includes master keying charges	\$172.00
DG364	Hardware prepared for DG3-6300 Lg. Format IC cores, supplied with temporary keyed construction cores	\$83.00
DX	Deadbolt Monitoring (not available with 50, 74)	\$197.00
LB	Extra large thumbturn	\$18.00
LC	Less Cylinder	-\$96.00/cyl.
LX	Latchbolt Monitor - available with all non-deadbolt functions; not available with DX option	\$200.00
OBS	Open Back Strike	\$79.00
RX	Request to Exit	\$206.00
SC▲†	Schlage "C" Keyway cylinder, (Number 41 Cylinder Only, 0 bitted)	No addition
SE▲†	Schlage "E" Keyway cylinder, (Number 41 Cylinder Only, 0 bitted)	No addition
SG	MicroShield® - an antimicrobial powder coat finish	\$73.00
WBS	Wrought Box Strike	No addition

NOTES: ▲ Options not avail. with a standard 50 function lockout cylinder. † Not avail. with 60, 63, 64 options

CPC	Clear Powder Coat over 26D/32D - 8205 x LNA x RH x 32D x CPC All orders will continue to be handled as a "special" when CPC is ordered.	\$67.00
-----	--	---------

Experience a safer
and more open world

Copyright © 2002-2021 Sargent Manufacturing Company, an ASSA ABLOY Group company. All rights reserved.
Reproduction in whole or in part without the express written permission of Sargent Manufacturing Company is prohibited.
Contact us at: 800-727-5477 or visit www.sargentlock.com. In Canada contact us at: 800-461-3007 or visit www.assaabloydss.ca

ASSA ABLOY

8200

USA & Canada
Prices Effective
May 1, 2021



LNA
(Handed)



LNE



LNF



LNW

Rose: O, E, L, LN (Shown) Levers: A, E, F, W (All Shown)

Function		Finish	
		10BE/26D/BSP/WSP	03/04/09/10/10B/10BL/14/15/20D/26/32/32D
Single Cyl			
8204	Storeroom or Closet		
8205	Office or Entry	\$1,094.00	\$1,118.00
8237	Classroom		
8255	Office or Entry		
<hr/>			
8206	Storeroom or Service		
8231	Utility		
8236	Closet		
8256	Office or Inner Entry	\$1,121.00	\$1,145.00
8257, 8258, 8267	Institutional Privacy		
8289	Holdback		
8291	All Purpose Holdback		
<hr/>			
Single Cyl With Deadbolt			
8224	Room Door		
8225	Dormitory or Exit		
8227	Closet or Storeroom		
8228, 8230	Dummy Trim Deadlock	\$1,153.00	\$1,177.00
8235	Storeroom		
8243	Apartment Corridor		
8245	Dormitory or Exit		
8247	Front Door or Apartment Corridor		
8251	Storeroom Deadbolt		
8250	Hotel Guest Lock	\$1,188.00	\$1,212.00
<hr/>			
Double Cyl No Deadbolt			
8216	Apartment or Exit or Public Toilet		
8217	Asylum or Institutional		
8238	Classroom Security Intruder		
8242	Classroom Security Intruder Latchbolt	\$1,205.00	\$1,229.00
8259	School Security		
8290	Classroom Security Holdback		
8292	All Purpose Holdback		
<hr/>			
Double Cyl With Deadbolt			
8226	Store Door		
8229	Dummy Trim Deadlock		
8239, 8240	Classroom Security Intruder		
8241	Classroom Security	\$1,228.00	\$1,252.00
8246	Dormitory or Exit		
8248	Store Door		
8249	Security Deadbolt		
8252	Institutional		
<hr/>			
Electro Mechanical Single Cyl – Specify 12V or 24V			
8270-12V / 8270-24V	Fail Safe	\$1,290.00	\$1,314.00
8271-12V / 8271-24V	Fail Secure		
<hr/>			
Electro Mechanical Double Cyl – Specify 12V or 24V			
8272-12V / 8272-24V	Fail Safe	\$1,347.00	\$1,371.00
8273-12V / 8273-24V	Fail Secure		
<hr/>			
Non Keyed			
8213	Communication or Exit	\$877.00	\$901.00
8215	Passage or Closet		
8265	Privacy Bedroom or Bath (Latch)	\$965.00	\$989.00
8266, 8268	Privacy Bedroom or Bath (Deadbolt)	\$1,069.00	\$1,093.00
8293*	Single Dummy Trim	\$362.00	\$374.00
8294	Double Dummy Trim	\$723.00	\$747.00
8295	Single Dummy Trim w/Lockbody	\$464.00	\$476.00
8296	Double Dummy Trim w/Lockbody	\$830.00	\$854.00
8297	Double Dummy w/Active Trim	\$920.00	\$944.00

*"A" Lever Only—Specify hand and if for inside or outside of door, when ordering.

Experience a safer
and more open world

ML-6 MORTISE LOCKS

For V Series
Indicators
Click / See
Page ML-1A

SARGENT®

ASSA ABLOY

OPTIONS USA & Canada Prices Effective May 1, 2021

Options	Description	Price
1▲	8200 Line with 1-1/16" wide front for 1-3/8" doors.	\$62.00
3	Stainless steel hub (not available with 8289, 8291 & 8292 functions)	\$69.00
10▲	SARGENT Signature Key System	\$63.00 / cyl.
11†▲	SARGENT XC Key System (not available w/10, KESO, SC, SE)	No addition
1160	SARGENT XC Large Format Interchangeable Plastic Disposable Construction Core	No addition
1163	SARGENT XC Large Format Interchangeable Core Cylinder - Includes masterkeying charges	\$83.00
1164	SARGENT XC Large Format Interchangeable Construction Core Cylinder	\$83.00
1170	Small Format interchangeable disposable construction core - to accept 7 Pin XC permanent core	No addition
11727P	Small Format interchangeable keyed construction core - to accept 7 Pin XC permanent core	\$75.00
11737P	Small Format interchangeable core - to accept 7 pin XC permanent core	\$75.00 / cyl.
21▲†	SARGENT Construction Key System (lost ball) Standard on all new systems established since 5/1/96	\$16.00 / cyl.
22▲†	SARGENT Construction Key System (split key) To be used on pre-established split key systems only	\$32.00 / cyl.
23	Locksets with flat 4 7/8" ANSI strike	No addition
31	Thick Doors - Extended Lip Required - Specify Length C to E IMPORTANT: See 7800/8200 Catalog Option Page for Cylinder Limits - DOES NOT include additional Charges for Special Cylinder Requirements Doors up to 2-1/2" thick - lock centered • Doors 2-5/8" to 6" thick OR doors 1-3/4" thick w/max 1" paneling one side. For example: Specify 1-3/4" door with panel (Side) on inside or outside	No addition Non Keyed function \$50.00 Keyed function \$100.00
36	6 Lobe security head screws	\$24.00
37	Spanner head screws	\$17.00
49	Visual Status Indicator - Available with 30, 36, 37 function - Rose Trims CR, E, L, LN, O, TR - Available with 26, 29, 38, 39 40, 41 functions - Rose Trim 8200 LN	\$140.00
49	Occupancy Indicator with emergency Release - Available with 65, 66, 68 functions; Rose Trims 7800 CR, E, L, LN, O, TR	\$140.00
50	Secured Indicator Rose- doors 1-5/8" to 2-1/4" thick- Avail.w/24,25,26,28,29,30,36,37,38,39,40,41,43,45,50,51,52,57,58,67 functions	\$140.00
60	SARGENT Large Format Interchangeable Plastic Disposable Construction Core	No addition
63	SARGENT Large Format Interchangeable core cylinder, includes master keying charges	\$83.00 / cyl
64	SARGENT Large Format Interchangeable Construction Core Cylinder	\$83.00
6573▲†	Small Format 6-Pin Uncombined Core (Refer to CK-12)	\$65.00 / cyl.
65737P▲†	Small Format 7-Pin Uncombined Core (Refer to CK-12)	\$65.00 / cyl.
68	8200 Line furnished with lever handle outside x knob inside (Excludes SLD Detention Knob)	Defaults to 8200 Lever Lock Price
69	8200 Line furnished with lever handle inside x knob outside (Excludes SLD Detention Knob)	Defaults to 8200 Lever Lock Price
70▲†	Small Format interchangeable disposable plastic construction core	No addition
72▲†	Small Format interchangeable 6-Pin construction core	\$75.00
73▲†	Small Format interchangeable core 6-pin Includes MK and GMK keying charges	\$75.00 / cyl
737P▲†	Small Format interchangeable core 7-pin (refer to CK-12 for available keyways) Includes MK and GMK keying charges	\$75.00 / cyl
74	Lock case wrapped in lead - handing required (roses not available)	\$294.00
75	Tactile Warning - Milled Inside Lever	\$78.00
76	Tactile Warning - Milled Outside Lever	\$78.00
77	Tactile Warning - Milled Outside and Inside Lever	\$156.00
81▲†	Cylinder to accept Keso (83) and Keso F1 (F183) removable core - no core provided	No addition
F182†	SARGENT Keso Security Cylinder - patented - new key systems	\$91.00 / cyl.
F183▲†	SARGENT Keso Security Removable Core Cylinder - patented - new key systems	\$130.00 / cyl.
82†	SARGENT Keso Security Cylinder (For existing systems only)	\$91.00 / cyl.
83▲†	SARGENT Keso Security Removable Core Cylinder (For existing systems only)	\$130.00 / cyl.
84▲†	SARGENT Keso Security Removable Construction Core Cylinder	See CK-18
85	Tactile Warning - Abrasive Coating on Inside Lever	\$49.00
86	Tactile Warning - Abrasive Coating on Outside Lever	\$49.00
87	Tactile Warning - Abrasive Coating on Outside & Inside Lever	\$98.00
AV	Anti Vandal Pull Trim (available in 32D finish), (Not available with 8270, 8271, 8272, 8273 functions)	\$229.00
BR	SARGENT Bump Resistant Cylinders (N/A w/10, 22, 30, 60, 63, 64, 70, 72, 73, 737P, KESO, SC, & SE options)	\$25.00 /cyl.
DG1	Patented Degree DG1 Key System	No addition
DG160	Hardware prepared for DG1-6300 Lg. Format IC cores, supplied with temporary plastic construction cores	No addition
DG163	Patented Degree DG1 Large Format Interchangeable Core Cylinder - Includes master keying charges	\$83.00
DG164	Hardware prepared for DG1-6300 Lg. Format IC cores, supplied with temporary keyed construction cores	\$83.00
DG2	Patented Degree DG2 Key System incorporating a locking sidebar	\$63.00/cyl.
DG260	Hardware prepared for DG2-6300 Lg. Format IC cores, supplied with temporary plastic construction cores	No addition
DG263	Patented Degree DG2 Large Format Interchangeable Core Cylinder - Includes master keying charges	\$146.00
DG264	Hardware prepared for DG2-6300 Lg. Format IC cores, supplied with temporary keyed construction cores	\$83.00
DG3	Patented Degree DG3 Key System incorporating a locking sidebar and UL437 listed	\$89.00/cyl.
DG360	Hardware prepared for DG3-6300 Lg. Format IC cores, supplied with temporary plastic construction cores	No addition
DG363	Patented Degree DG3 Large Format Interchangeable Core Cylinder - Includes master keying charges	\$172.00
DG364	Hardware prepared for DG3-6300 Lg. Format IC cores, supplied with temporary keyed construction cores	\$83.00
IDP	Integrated Door Position Switch	\$108.00
LB	Extra large thumbturn	\$18.00
LC	Less Cylinder	-\$96.00/cyl.
OBS	Open Back Strike	\$79.00
PHR	Deadbolt Privacy Function (available w/deadbolt function only)	\$100.00
R01	Mercury and Lenel compatible 1KΩ/2KΩ resistance supervision	\$100.00
R03	Software House compatible 1KΩ/2KΩ resistance supervision	\$100.00
R04	AMAG compatible 4-state supervision	\$100.00
SC▲†	Schlage "C" Keyway cylinder, (Number 41 Cylinder Only, 0 bitted)	No addition
SE▲†	Schlage "E" Keyway cylinder, (Number 41 Cylinder Only, 0 bitted)	No addition
SG	MicroShield® - an antimicrobial powder coat finish	\$73.00
WBS	Wrought Box Strike	No addition
NOTES:	▲ Options not avail. with a standard 50 function lockout cylinder. † Not avail. with 60, 63, 64 options	
CPC	Clear Powder Coat over 26D/32D - NAC-82271-12V x LNA x RH x 32D x CPC All orders will continue to be handled as a "special" when CPC is ordered.	\$67.00

Experience a safer
and more open world

Copyright © 2002-2021 Sargent Manufacturing Company, an ASSA ABLOY Group company. All rights reserved.
Reproduction in whole or in part without the express written permission of Sargent Manufacturing Company is prohibited.
Contact us at: 800-727-5477 or visit www.sargentlock.com. In Canada contact us at: 800-461-3007 or visit www.assaabloydss.ca

USA & Canada
Prices Effective
May 1, 2021



Rose: O, E, L, LN (Shown) Levers: A, E, F, W (All Shown)

NAC 8200 Electrified Mortise Locks with High Security Monitoring				10BE/26D/ BSP/WSP	03/04/09/10/ 10B/10BL/14/15/ 20D/26/32/32D
Option	Function	Trim - Proximity Entry	Description		
NAC	82270-12V/-24V	Rose x Lever Design	Fail Safe w/Cylinder Override	\$1,465.00	\$1,489.00
NAC	82271-12V/-24V	Rose x Lever Design	Fail Secure w/Cylinder Override		
NAC	82280-12V/-24V	Rose x Lever Design	Fail Safe w/Deadbolt w/Cyl.Override	\$1,540.00	\$1,564.00
NAC	82281-12V/-24V	Rose x Lever Design	Fail Secure w/D.bolt w/Cyl.Override		
NAC	82274-12V/-24V	Rose x Lever Design	Fail Safe - No Cylinder	\$1,410.00	\$1,434.00
NAC	82275-12V/-24V	Rose x Lever Design	Fail Secure - No Cylinder		
NAC	82284-12V/-24V	Rose x Lever Design	Fail Safe w/Deadbolt - No Cylinder	\$1,485.00	\$1,509.00
NAC	82285-12V/-24V	Rose x Lever Design	Fail Secure w/Deadbolt - No Cylinder		

Note: Consult catalog for ordering information.
Specify hand and voltage (12v or 24v) when ordering.

ML-8 MORTISE LOCKS

For V Series
Indicators
Click / See
Page ML-1A

SARGENT®

ASSA ABLOY

OPTIONS

USA & Canada Prices Effective May 1, 2021

Options	Description	Price
1▲	8200 Line with 1-1/16" wide front for 1-3/8" doors.	\$62.00
3	Stainless steel hub (not available with 8289, 8291 & 8292 functions)	\$69.00
10▲	SARGENT Signature Key System	\$63.00 / cyl.
11†▲	SARGENT XC Key System (not available with 10, 22, SC, SE options)	No addition
1160	SARGENT XC Large Format Interchangeable Plastic Disposable Construction Core	No addition
1163	SARGENT XC Large Format Interchangeable Core Cylinder - Includes masterkeying charges	\$83.00
1164	SARGENT XC Large Format Interchangeable Construction Core Cylinder	\$83.00
1170	Small Format interchangeable disposable construction core - to accept 7 Pin XC permanent core	No addition
11727P	Small Format interchangeable keyed construction core - to accept 7 Pin XC permanent core	\$75.00
11737P	Small Format interchangeable core - to accept 7 pin XC permanent core	\$75.00 / cyl.
21▲†	SARGENT Construction Key System (lost ball) Standard on all new systems established since 5/1/96	\$16.00 / cyl.
22▲†	SARGENT Construction Key System (split key) To be used on pre-established split key systems only	\$32.00 / cyl.
23	Locksets with flat 4 7/8" ANSI strike	No addition
31	Thick Doors - Extended Lip Required - Specify Length C to E - Cylinders - IMPORTANT- See catalog 7800/8200 option page for cylinder limitations - Below charges DO NOT include additional charges for special cylinder requirements	No addition
	Doors up to 2-1/2" thick - lock centered	No addition
	Doors 2-5/8" to 6" thick OR doors 1-3/4" thick w/max 1" paneling one side.	
	For example: Specify 1-3/4" door with panel (Side) on inside or outside	Non Keyed function \$50.00 Keyed function \$100.00
36	6 Lobe security head screws	\$24.00
37	Spanner head screws	\$17.00
49	Visual Status Indicator - Available with 30, 36, 37 function - Rose Trims 7800 CR, E, L, LN, O, TR - Available with 26, 29, 38, 39 40, 41 functions - Rose Trim 8200 LN	\$140.00
49	Occupancy Indicator with emergency Release - Available with 65, 66, 68 functions; Rose Trims 7800 CR, E, L, LN, O, TR	\$140.00
50	Secured Indicator Rose- doors 1-5/8" to 2-1/4" thick- Avail.w/24,25,26,28,29,30,36,37,38,39,40,41,43,45,50,51,52,57,58,67 functions	\$140.00
60	SARGENT Large Format Interchangeable Plastic Disposable Construction Core	No addition
63	SARGENT Large Format Interchangeable core cylinder, includes master keying charges	\$83.00 / cyl.
64	SARGENT Large Format Interchangeable Construction Core Cylinder	\$83.00
6573▲†	Small Format 6-Pin Uncombined Core (Refer to CK-12)	\$65.00 / cyl.
65737P▲†	Small Format 7-Pin Uncombined Core (Refer to CK-12)	\$65.00 / cyl.
68	8200 Line furnished with lever handle outside x knob inside (Excludes SLD Detention Knob)	Defaults to 8200 Lever Lock Price
69	8200 Line furnished with lever handle inside x knob outside (Excludes SLD Detention Knob)	Defaults to 8200 Lever Lock Price
70▲†	Small Format interchangeable disposable plastic construction core	No addition
72▲†	Small Format interchangeable 6-pin construction core (7-pin with 11 option)	\$75.00
73▲†	Small Format 6-pin interchangeable core (refer to CK-8 for available keyways)	\$75.00 / cyl
737P▲†	Small Format 7-pin interchangeable core (refer to CK-8 for available keyways)	\$75.00 / cyl
74	Lock case wrapped in lead - handing required (roses not available)	\$294.00
75	Tactile Warning - Milled Inside Lever	\$78.00
76	Tactile Warning - Milled Outside Lever	\$78.00
77	Tactile Warning - Milled Outside and Inside Lever	\$156.00
81▲†	Cylinder to accept Keso (83) and Keso F1 (F183) removable core - no core provided	No addition
F182†	SARGENT Keso Security Cylinder - patented - new key systems	\$91.00 / cyl.
F183▲†	SARGENT Keso Security Removable Core Cylinder - patented - new key systems	\$130.00 / cyl.
82†	SARGENT Keso Security Cylinder (For existing systems only)	\$91.00 / cyl.
83▲†	SARGENT Keso Security Removable Core Cylinder (For existing systems only)	\$130.00 / cyl.
84▲†	SARGENT Keso Security Removable Construction Core Cylinder	See CK-18
85	Tactile Warning - Abrasive Coating on Inside Lever	\$49.00
86	Tactile Warning - Abrasive Coating on Outside Lever	\$49.00
87	Tactile Warning - Abrasive Coating on Outside & Inside Lever	\$98.00
AV	Anti Vandal Pull Trim (available in 32D finish), (Not available with 8270, 8271, 8272, 8273 functions)	\$229.00
BR	SARGENT Bump Resistant Cylinders (N/A w/10, 22, 30, 60, 63, 64, 70, 72, 73, 737P, KESO, SC, & SE options)	\$25.00 /cyl.
DG1	Patented Degree DG1 Key System	No addition
DG160	Hardware prepared for DG1-6300 Lg. Format IC cores, supplied with temporary plastic construction cores	No addition
DG163	Patented Degree DG1 Large Format Interchangeable Core Cylinder - Includes master keying charges	\$83.00
DG164	Hardware prepared for DG1-6300 Lg. Format IC cores, supplied with temporary keyed construction cores	\$83.00
DG2	Patented Degree DG2 Key System incorporating a locking sidebar	\$63.00/cyl.
DG260	Hardware prepared for DG2-6300 Lg. Format IC cores, supplied with temporary plastic construction cores	No addition
DG263	Patented Degree DG2 Large Format Interchangeable Core Cylinder - Includes master keying charges	\$146.00
DG264	Hardware prepared for DG2-6300 Lg. Format IC cores, supplied with temporary keyed construction cores	\$83.00
DG3	Patented Degree DG3 Key System incorporating a locking sidebar and UL437 listed	\$89.00/cyl.
DG360	Hardware prepared for DG3-6300 Lg. Format IC cores, supplied with temporary plastic construction cores	No addition
DG363	Patented Degree DG3 Large Format Interchangeable Core Cylinder - Includes master keying charges	\$172.00
DG364	Hardware prepared for DG3-6300 Lg. Format IC cores, supplied with temporary keyed construction cores	\$83.00 outside
DX	Deadbolt Monitoring (not available with 50, 74)	\$197.00
LB	Extra large thumbturn	\$18.00
LC	Less Cylinder	-\$96.00/cyl.
LX	Latchbolt Monitor - available with all non-deadbolt functions; not available with DX option	\$200.00
OBS	Open Back Strike	\$79.00
RX	Request to Exit	\$206.00
SC▲†	Schlage "C" Keyway cylinder, (Number 41 Cylinder Only, 0 bitted)	No addition
SE▲†	Schlage "E" Keyway cylinder, (Number 41 Cylinder Only, 0 bitted)	No addition
SG	MicroShield® - an antimicrobial powder coat finish	\$73.00
WBS	Wrought Box Strike	No addition

NOTES: ▲ Options not avail. with a standard 50 function lockout cylinder. † Not avail. with 60, 63, 64 options

CPC Clear Powder Coat over 26D/32D - 8205 x LNL x 32D x CPC \$67.00
All orders will continue to be handled as a "special" when CPC is ordered.

Experience a safer
and more open world

Copyright © 2002-2021 Sargent Manufacturing Company, an ASSA ABLOY Group company. All rights reserved.
Reproduction in whole or in part without the express written permission of Sargent Manufacturing Company is prohibited.
Contact us at: 800-727-5477 or visit www.sargentlock.com. In Canada contact us at: 800-461-3007 or visit www.assaabloydss.ca

ASSA ABLOY

8200



LNB



LNL



LNP

USA & Canada
Prices Effective
May 1, 2021

Rose: O, E, L, LN (Shown) Levers: B, L, P (All shown)

Function		Finish	
Single Cyl		10BE/26D/BSP/WSP	03/04/09/10/10B/10BL/14/15/20D/26/32/32D
8204	Storeroom or Closet		
8205	Office or Entry		
8237	Classroom	\$1,065.00	\$1,089.00
8255	Office or Entry		
8206	Storeroom or Service		
8231	Utility		
8236	Closet		
8256	Office or Inner Entry	\$1,084.00	\$1,108.00
8257, 8258, 8267	Institutional Privacy		
8289	Holdback		
8291	All Purpose Holdback		
Single Cyl With Deadbolt			
8224	Room Door		
8225	Dormitory or Exit		
8227	Closet or Storeroom		
8228, 8230	Dummy Trim Deadlock		
8235	Storeroom	\$1,115.00	\$1,139.00
8243	Apartment Corridor		
8245	Dormitory or Exit		
8247	Front Door or Apartment Corridor		
8251	Storeroom Deadbolt		
8250	Hotel Guest Lock	\$1,160.00	\$1,184.00
Double Cyl No Deadbolt			
8216	Apartment or Exit or Public Toilet		
8217	Asylum or Institutional		
8238	Classroom Security Intruder		
8242	Classroom Security Intruder Latchbolt	\$1,171.00	\$1,195.00
8259	School Security		
8290	Classroom Security Holdback		
8292	All Purpose Holdback		
Double Cyl With Deadbolt			
8226	Store Door		
8229	Dummy Trim Deadlock		
8239, 8240	Classroom Security Intruder		
8241	Classroom Security	\$1,184.00	\$1,208.00
8246	Dormitory or Exit		
8248	Store Door		
8249	Security Deadbolt		
8252	Institutional		
Electro Mechanical Single Cyl – Specify 12V or 24V			
8270-12V / 8270-24V	Fail Safe	\$1,261.00	\$1,285.00
8271-12V / 8271-24V	Fail Secure		
Electro Mechanical Double Cyl – Specify 12V or 24V			
8272-12V / 8272-24V	Fail Safe	\$1,318.00	\$1,342.00
8273-12V / 8273-24V	Fail Secure		
Non Keyed			
8213	Communication or Exit	\$841.00	\$865.00
8215	Passage or Closet		
8265	Privacy Bedroom or Bath (Latch)	\$949.00	\$973.00
8266, 8268	Privacy Bedroom or Bath (Deadbolt)	\$1,038.00	\$1,062.00
8293	Single Dummy Trim	\$342.00	\$354.00
8294	Double Dummy Trim	\$691.00	\$715.00
8295	Single Dummy Trim w/Lockbody	\$450.00	\$462.00
8296	Double Dummy Trim w/Lockbody	\$794.00	\$818.00
8297	Double Dummy w/Active Trim	\$884.00	\$908.00

Experience a safer
and more open world

ML-10 MORTISE LOCKS

**For V Series
Indicators
Click / See
Page ML-1A**

SARGENT®

ASSA ABLOY

OPTIONS

USA & Canada Prices Effective May 1, 2021

Options	Description	Price
1▲	8200 Line with 1-1/16" wide front for 1-3/8" doors.	\$62.00
3	Stainless steel hub (not available with 8289, 8291 & 8292 functions)	\$69.00
10▲	SARGENT Signature Key System	\$63.00 / cyl.
11▲	SARGENT XC Key System (not available w/10, KESO, SC, SE)	No addition
1160	SARGENT XC Large Format Interchangeable Plastic Disposable Construction Core	No addition
1163	SARGENT XC Large Format Interchangeable Core Cylinder - Includes masterkeying charges	\$83.00
1164	SARGENT XC Large Format Interchangeable Construction Core Cylinder	\$83.00
1170	Small Format interchangeable disposable construction core - to accept 7 Pin XC permanent core	No addition
11727P	Small Format interchangeable keyed construction core - to accept 7 Pin XC permanent core	\$75.00
11737P	Small Format interchangeable core - to accept 7 pin XC permanent core	\$75.00 / cyl.
21▲†	SARGENT Construction Key System (lost ball) Standard on all new systems established since 5/1/96	\$16.00 / cyl.
22▲†	SARGENT Construction Key System (split key) To be used on pre-established split key systems only	\$32.00 / cyl.
23	Locksets with flat 4 7/8" ANSI strike	No addition
31	Thick Doors - Extended Lip Required - Specify Length C to E IMPORTANT: See 7800/8200 Catalog Option Page for Cylinder Limits – DOES NOT include additional Charges for Special Cylinder Requirements	No addition
	Doors up to 2-1/2" thick - lock centered • Doors 2-5/8" to 6" thick OR doors 1-3/4" thick w/max 1" paneling one side. For example: Specify 1-3/4" door with panel (Side) on inside or outside	Non Keyed function \$50.00 Keyed function \$100.00
36	6 Lobe security head screws	\$24.00
37	Spanner head screws	\$17.00
49	Visual Status Indicator – Available with 30, 36, 37 function – Rose Trims CR, E, L, LN, O, TR – Available with 26, 29, 38, 39 40, 41 functions – Rose Trim 8200 LN	\$140.00
49	Occupancy Indicator with emergency Release – Available with 65, 66, 68 functions; Rose Trims 7800 CR, E, L, LN, O, TR	\$140.00
50	Secured Indicator Rose– doors 1-5/8" to 2-1/4" thick– Avail.w/24,25,26,28,29,30,36,37,38,39,40,41,43,45,50,51,52,57,58,67 functions	\$140.00
60	SARGENT Large Format Interchangeable Plastic Disposable Construction Core	No addition
63	SARGENT Large Format Interchangeable core cylinder, includes master keying charges	\$83.00 / cyl
64	SARGENT Large Format Interchangeable Construction Core Cylinder	\$83.00
6573▲†	Small Format 6-Pin Uncombined Core (Refer to CK-12)	\$65.00 / cyl.
65737P▲†	Small Format 7-Pin Uncombined Core (Refer to CK-12)	\$65.00 / cyl.
68	8200 Line furnished with lever handle outside x knob inside (Excludes SLD Detention Knob)	Defaults to 8200 Lever Lock Price
69	8200 Line furnished with lever handle inside x knob outside (Excludes SLD Detention Knob)	Defaults to 8200 Lever Lock Price
70▲†	Small Format interchangeable disposable plastic construction core	No addition
72▲†	Small Format interchangeable 6-Pin construction core	\$75.00
73▲†	Small Format interchangeable core 6-pin Includes MK and GMK keying charges	\$75.00 / cyl
737P▲†	Small Format interchangeable core 7-pin (refer to CK-12 for available keyways) Includes MK and GMK keying charges	\$75.00 / cyl
74	Lock case wrapped in lead – handing required (roses not available)	\$294.00
75	Tactile Warning - Milled Inside Lever	\$78.00
76	Tactile Warning - Milled Outside Lever	\$78.00
77	Tactile Warning - Milled Outside and Inside Lever	\$156.00
81▲†	Cylinder to accept Keso (83) and Keso F1 (F183) removable core – no core provided	No addition
F182†	SARGENT Keso Security Cylinder – patented – new key systems	\$91.00 / cyl.
F183▲†	SARGENT Keso Security Removable Core Cylinder – patented – new key systems	\$130.00 / cyl.
82†	SARGENT Keso Security Cylinder (For existing systems only)	\$91.00 / cyl.
83▲†	SARGENT Keso Security Removable Core Cylinder (For existing systems only)	\$130.00 / cyl.
84▲†	SARGENT Keso Security Removable Construction Core Cylinder	See CK-18
85	Tactile Warning - Abrasive Coating on Inside Lever	\$49.00
86	Tactile Warning - Abrasive Coating on Outside Lever	\$49.00
87	Tactile Warning - Abrasive Coating on Outside & Inside Lever	\$98.00
AV	Anti Vandal Pull Trim (available in 32D finish) (Not available with 8270, 8271, 8272, 8273 functions)	\$229.00
BR	SARGENT Bump Resistant Cylinders (N/A w/10, 22, 30, 60, 63, 64, 70, 72, 73, 737P, KESO, SC, & SE options)	\$25.00 /cyl.
DG1	Patented Degree DG1 Key System	No addition
DG160	Hardware prepared for DG1-6300 Lg. Format IC cores, supplied with temporary plastic construction cores	No addition
DG163	Patented Degree DG1 Large Format Interchangeable Core Cylinder - Includes master keying charges	\$83.00
DG164	Hardware prepared for DG1-6300 Lg. Format IC cores, supplied with temporary keyed construction cores	\$83.00
DG2	Patented Degree DG2 Key System incorporating a locking sidebar	\$63.00/cyl.
DG260	Hardware prepared for DG2-6300 Lg. Format IC cores, supplied with temporary plastic construction cores	No addition
DG263	Patented Degree DG2 Large Format Interchangeable Core Cylinder - Includes master keying charges	\$146.00
DG264	Hardware prepared for DG2-6300 Lg. Format IC cores, supplied with temporary keyed construction cores	\$83.00
DG3	Patented Degree DG3 Key System incorporating a locking sidebar and UL437 listed	\$89.00/cyl.
DG360	Hardware prepared for DG3-6300 Lg. Format IC cores, supplied with temporary plastic construction cores	No addition
DG363	Patented Degree DG3 Large Format Interchangeable Core Cylinder - Includes master keying charges	\$172.00
DG364	Hardware prepared for DG3-6300 Lg. Format IC cores, supplied with temporary keyed construction cores	\$83.00
IDP	Integrated Door Position Switch	\$108.00
LB	Extra large thumbturn	\$18.00
LC	Less Cylinder	-\$96.00/cyl.
OBS	Open Back Strike	\$79.00
PHR	Deadbolt Privacy Function (available w/deadbolt function only)	\$100.00
R01	Mercury and Lenel compatible 1KΩ/2KΩ resistance supervision	\$100.00
R03	Software House compatible 1KΩ/2KΩ resistance supervision	\$100.00
R04	AMAG compatible 4-state supervision	\$100.00
SC▲†	Schlage "C" Keyway cylinder, (Number 41 Cylinder Only, 0 bitted)	No addition
SE▲†	Schlage "E" Keyway cylinder, (Number 41 Cylinder Only, 0 bitted)	No addition
SG	MicroShield® – an antimicrobial powder coat finish	\$73.00
WBS	Wrought Box Strike	No addition
NOTES:	▲ Options not avail. with a standard 50 function lockout cylinder. † Not avail. with 60, 63, 64 options	
CPC	Clear Powder Coat over 26D/32D – NAC 82271-12V x LNA x RH x 32D x CPC	\$67.00
	All orders will continue to be handled as a "special" when CPC is ordered.	

Experience a safer
and more open world

Copyright © 2002-2021 Sargent Manufacturing Company, an ASSA ABLOY Group company. All rights reserved.
Reproduction in whole or in part without the express written permission of Sargent Manufacturing Company is prohibited.
Contact us at: 800-727-5477 or visit www.sargentlock.com. In Canada contact us at: 800-461-3007 or visit www.assaabloydss.ca

ASSA ABLOY

NAC 8200 SERIES

USA & Canada Prices Effective May 1, 2021



LNB



LNL



LNP

Rose: O, E, L, LN (Shown) Levers: B, L, P (All shown)

NAC 8200 Electrified Mortise Locks with High Security Monitoring				10BE/26D/ BSP/WSP	03/04/09/10/ 10B/10BL/14/15/ 20D/26/32/32D
Option	Function	Trim - Proximity Entry	Description		
NAC	82270-12V/-24V	Rose x Lever Design	Fail Safe w/Cylinder Override	\$1,436.00	\$1,460.00
NAC	82271-12V/-24V	Rose x Lever Design	Fail Secure w/Cylinder Override		
NAC	82280-12V/-24V	Rose x Lever Design	Fail Safe w/Deadbolt w/Cyl.Override	\$1,511.00	\$1,535.00
NAC	82281-12V/-24V	Rose x Lever Design	Fail Secure w/D.bolt w/Cyl.Override		
NAC	82274-12V/-24V	Rose x Lever Design	Fail Safe - No Cylinder	\$1,381.00	\$1,405.00
NAC	82275-12V/-24V	Rose x Lever Design	Fail Secure - No Cylinder		
NAC	82284-12V/-24V	Rose x Lever Design	Fail Safe w/Deadbolt - No Cylinder	\$1,456.00	\$1,480.00
NAC	82285-12V/-24V	Rose x Lever Design	Fail Secure w/Deadbolt - No Cylinder		

Note: Consult catalog for ordering information.

Specify hand and voltage (12v or 24v) when ordering

ML-12 MORTISE LOCKS

For V Series
Indicators
Click / See
Page ML-1A

SARGENT®

ASSA ABLOY

OPTIONS

USA & Canada Prices Effective May 1, 2021

Options	Description	Price
1▲	8200 Line with 1-1/16" wide front for 1-3/8" doors.	\$62.00
3	Stainless steel hub (not available with 8289, 8291 & 8292 functions)	\$69.00
10▲	SARGENT Signature Key System	\$63.00 / cyl.
11†▲	SARGENT XC Key System (not available with 10, 22, SC, SE options)	No addition
1160	SARGENT XC Large Format Interchangeable Plastic Disposable Construction Core	No addition
1163	SARGENT XC Large Format Interchangeable Core Cylinder - Includes masterkeying charges	\$83.00
1164	SARGENT XC Large Format Interchangeable Construction Core Cylinder	\$83.00
1170	Small Format interchangeable disposable construction core - to accept 7 Pin XC permanent core	No addition
11727P	Small Format interchangeable keyed construction core - to accept 7 Pin XC permanent core	\$75.00
11737P	Small Format interchangeable core - to accept 7 pin XC permanent core	\$75.00 / cyl.
21▲†	SARGENT Construction Key System (lost ball) Standard on all new systems established since 5/1/96	\$16.00 / cyl.
22▲†	SARGENT Construction Key System (split key) To be used on pre-established split key systems only	\$32.00 / cyl.
23	Locksets with flat 4 7/8" ANSI strike	No addition
31	Thick Doors - Extended Lip Required - Specify Length C to E - Cylinders - IMPORTANT- See catalog 7800/8200 option page for cylinder limitations - Below charges DO NOT include additional charges for special cylinder requirements Doors up to 2-1/2" thick - lock centered Doors 2-5/8" to 6" thick OR doors 1-3/4" thick w/max 1" paneling one side. For example: Specify 1-3/4" door with panel (Side) on inside or outside	No addition Non Keyed function \$50.00 Keyed function \$100.00
36	6 Lobe security head screws	\$24.00
37	Spanner head screws	\$17.00
49	Visual Status Indicator - Available with 30, 36, 37 function - Rose Trims CR, E, L, LN, O, TR - Available with 26, 29, 38, 39 40, 41 functions - Rose Trim 8200 LN	\$140.00
49	Occupancy Indicator with emergency Release - Available with 65, 66, 68 functions; Rose Trims 7800 CR, E, L, LN, O, TR	\$140.00
50	Secured Indicator Rose- doors 1-5/8" to 2-1/4" thick- Avail.w/24,25,26,28,29,30,36,37,38,39,40,41,43,45,50,51,52,57,58,67 functions	\$140.00
60	SARGENT Large Format Interchangeable Plastic Disposable Construction Core	No addition
63	SARGENT Large Format Interchangeable core cylinder, includes master keying charges	\$83.00 / cyl.
64	SARGENT Large Format Interchangeable Construction Core Cylinder	\$83.00
6573▲†	Small Format 6-Pin Uncombined Core (Refer to CK-12)	\$65.00 / cyl.
65737P▲†	Small Format 7-Pin Uncombined Core (Refer to CK-12)	\$65.00 / cyl.
68	8200 Line furnished with lever handle outside x knob inside (Excludes SLD Detention Knob)	Defaults to 8200 Lever Lock Price
69	8200 Line furnished with lever handle inside x knob inside (Excludes SLD Detention Knob)	Defaults to 8200 Lever Lock Price
70▲†	Small Format interchangeable disposable plastic construction core	No addition
72▲†	Small Format interchangeable 6-pin construction core (7-pin with 11 option)	\$75.00
73▲†	Small Format interchangeable core 6-pin Includes MK and GMK keying charges	\$75.00 / cyl
737P▲†	Small Format interchangeable core 7-pin (refer to CK-12 for available keyways) Includes MK and GMK keying charges	\$75.00 cyl
74	Lock case wrapped in lead - handing required (roses not available)	\$294.00
75	Tactile Warning - Milled Inside Lever	\$78.00
76	Tactile Warning - Milled Outside Lever	\$78.00
77	Tactile Warning - Milled Outside and Inside Lever	\$156.00
81▲†	Cylinder to accept Keso (83) and Keso F1 (F183) removable core - no core provided	No addition
F182†	SARGENT Keso Security Cylinder - patented - new key systems	\$91.00 cyl.
F183▲†	SARGENT Keso Security Removable Core Cylinder - patented - new key systems	\$130.00 / cyl.
82†	SARGENT Keso Security Cylinder (For existing systems only)	\$91.00 / cyl.
83▲†	SARGENT Keso Security Removable Core Cylinder (For existing systems only)	\$130.00 / cyl.
84▲†	SARGENT Keso Security Removable Construction Core Cylinder	See CK-18
85	Tactile Warning - Abrasive Coating on Inside Lever	\$49.00
86	Tactile Warning - Abrasive Coating on Outside Lever	\$49.00
87	Tactile Warning - Abrasive Coating on Outside & Inside Lever	\$98.00
AV	Anti Vandal Pull Trim (available in 32D finish), (Not available with 8270, 8271, 8272, 8273 functions)	\$229.00
BR	SARGENT Bump Resistant Cylinders (N/A w/10, 22, 30, 60, 63, 64, 70, 72, 73, 737P, KESO, SC, & SE options)	\$25.00 /cyl.
DG1	Patented Degree DG1 Key System	No addition
DG160	Hardware prepared for DG1-6300 Lg. Format IC cores, supplied with temporary plastic construction cores	No addition
DG163	Patented Degree DG1 Large Format Interchangeable Core Cylinder - Includes master keying charges	\$83.00
DG164	Hardware prepared for DG1-6300 Lg. Format IC cores, supplied with temporary keyed construction cores	\$83.00
DG2	Patented Degree DG2 Key System incorporating a locking sidebar	\$63.00/cyl.
DG260	Hardware prepared for DG2-6300 Lg. Format IC cores, supplied with temporary plastic construction cores	No addition
DG263	Patented Degree DG2 Large Format Interchangeable Core Cylinder - Includes master keying charges	\$146.00
DG264	Hardware prepared for DG2-6300 Lg. Format IC cores, supplied with temporary keyed construction cores	\$83.00
DG3	Patented Degree DG3 Key System incorporating a locking sidebar and UL437 listed	\$89.00/cyl.
DG360	Hardware prepared for DG3-6300 Lg. Format IC cores, supplied with temporary plastic construction cores	No addition
DG363	Patented Degree DG3 Large Format Interchangeable Core Cylinder - Includes master keying charges	\$172.00
DG364	Hardware prepared for DG3-6300 Lg. Format IC cores, supplied with temporary keyed construction cores	\$83.00
DX	Deadbolt Monitoring (not available with 50, 74)	\$197.00
LB	Extra large thumbturn	\$18.00
LC	Less Cylinder	-\$96.00/cyl.
LX	Latchbolt Monitor - available with all non-deadbolt functions; not available with DX option	\$200.00
OBS	Open Back Strike	\$79.00
RX	Request to Exit	\$206.00
SC▲†	Schlage "C" Keyway cylinder, (Number 41 Cylinder Only, 0 bitted)	No addition
SE▲†	Schlage "E" Keyway cylinder, (Number 41 Cylinder Only, 0 bitted)	No addition
SG	MicroShield® - an antimicrobial powder coat finish	\$73.00
WBS	Wrought Box Strike	No addition

NOTES: ▲ Options not avail. with a standard 50 function lockout cylinder. † Not avail. with 60, 63, 64 options

CPC	Clear Powder Coat over 26D/32D - 8205 x LNj x 32D x CPC All orders will continue to be handled as a "special" when CPC is ordered.	\$67.00
-----	---	---------

Experience a safer
and more open world

Copyright © 2002-2021 Sargent Manufacturing Company, an ASSA ABLOY Group company. All rights reserved.
Reproduction in whole or in part without the express written permission of Sargent Manufacturing Company is prohibited.
Contact us at: 800-727-5477 or visit www.sargentlock.com. In Canada contact us at: 800-461-3007 or visit www.assaabloydss.ca



LNJ

USA & Canada Prices Effective May 1, 2021

Rose: O, E, L, LN (Shown) Lever: J (Shown)

Function		Finish	
Single Cyl		10BE/26D/BSP/WSP	03/04/09/10/10B/10BL/14/15/20D/26/32/32D
8204	Storeroom or Closet		
8205	Office or Entry		
8237	Classroom	\$925.00	\$1,049.00
8255	Office or Entry		
8206	Storeroom or Service		
8231	Utility		
8236	Closet		
8256	Office or Inner Entry	\$944.00	\$1,072.00
8257, 8258, 8267	Institutional Privacy		
8289	Holdback		
8291	All Purpose Holdback		
Single Cyl With Deadbolt			
8224	Room Door		
8225	Dormitory or Exit		
8227	Closet or Storeroom		
8228, 8230	Dummy Trim Deadlock		
8235	Storeroom	\$977.00	\$1,109.00
8243	Apartment Corridor		
8245	Dormitory or Exit		
8247	Front Door or Apartment Corridor		
8251	Storeroom Deadbolt		
8250	Hotel Guest Lock	\$1,019.00	\$1,157.00
Double Cyl No Deadbolt			
8216	Apartment or Exit or Public Toilet		
8217	Asylum or Institutional		
8238	Classroom Security Intruder		
8242	Classroom Security Intruder Latchbolt	\$1,037.00	\$1,169.00
8259	School Security		
8290	Classroom Security Holdback		
8292	All Purpose Holdback		
Double Cyl With Deadbolt			
8226	Store Door		
8229	Dummy Trim Deadlock		
8239, 8240	Classroom Security Intruder		
8241	Classroom Security	\$1,065.00	\$1,204.00
8246	Dormitory or Exit		
8248	Store Door		
8249	Security Deadbolt		
8252	Institutional		
Electro Mechanical Single Cyl – Specify 12V or 24V			
8270-12V / 8270-24V	Fail Safe	\$1,187.00	\$1,338.00
8271-12V / 8271-24V	Fail Secure		
Electro Mechanical Double Cyl – Specify 12V or 24V			
8272-12V / 8272-24V	Fail Safe	\$1,262.00	\$1,421.00
8273-12V / 8273-24V	Fail Secure		
Non Keyed			
8213	Communication or Exit	\$703.00	\$807.00
8215	Passage or Closet		
8265	Privacy Bedroom or Bath (Latch)	\$815.00	\$930.00
8266, 8268	Privacy Bedroom or Bath (Deadbolt)	\$906.00	\$1,029.00
8293	Single Dummy Trim	\$264.00	\$309.00
8294	Double Dummy Trim	\$537.00	\$626.00
8295	Single Dummy Trim w/Lockbody	\$377.00	\$431.00
8296	Double Dummy Trim w/Lockbody	\$650.00	\$748.00
8297	Double Dummy w/Active Trim	\$736.00	\$844.00

ML-14 MORTISE LOCKS

For V Series
Indicators
Click / See
Page ML-1A

SARGENT®

ASSA ABLOY

OPTIONS

USA & Canada Prices Effective May 1, 2021

Options	Description	Price
1▲	8200 Line with 1-1/16" wide front for 1-3/8" doors.	\$62.00
3	Stainless steel hub (not available with 8289, 8291 & 8292 functions)	\$69.00
10▲	SARGENT Signature Key System	\$63.00 / cyl.
11▲	SARGENT XC Key System (not available w/10, KESO, SC, SE)	No addition
1160	SARGENT XC Large Format Interchangeable Plastic Disposable Construction Core	No addition
1163	SARGENT XC Large Format Interchangeable Core Cylinder - Includes masterkeying charges	\$83.00
1164	SARGENT XC Large Format Interchangeable Construction Core Cylinder	\$83.00
1170	Small Format interchangeable disposable construction core - to accept 7 Pin XC permanent core	No addition
11727P	Small Format interchangeable keyed construction core - to accept 7 Pin XC permanent core	\$75.00
11737P	Small Format interchangeable core - to accept 7 pin XC permanent core	\$75.00 / cyl.
21▲†	SARGENT Construction Key System (lost ball) Standard on all new systems established since 5/1/96	\$16.00 / cyl.
22▲†	SARGENT Construction Key System (split key) To be used on pre-established split key systems only	\$32.00 / cyl.
23	Locksets with flat 4 7/8" ANSI strike	No addition
31	Thick Doors - Extended Lip Required - Specify Length C to E IMPORTANT: See 7800/8200 Catalog Option Page for Cylinder Limits - DOES NOT include additional Charges for Special Cylinder Requirements	No addition
	Doors up to 2-1/2" thick - lock centered • Doors 2-5/8" to 6" thick OR doors 1-3/4" thick w/max 1" paneling one side. For example: Specify 1-3/4" door with panel (Side) on inside or outside	Non Keyed function \$50.00 Keyed function \$100.00
36	6 Lobe security head screws	\$24.00
37	Spanner head screws	\$17.00
49	Visual Status Indicator - Available with 30, 36, 37 function - Rose Trims CR, E, L, LN, O, TR - Available with 26, 29, 38, 39 40, 41 functions - Rose Trim 8200 LN	\$140.00
49	Occupancy Indicator with emergency Release - Available with 65, 66, 68 functions; Rose Trims 7800 CR, E, L, LN, O, TR	\$140.00
50	Secured Indicator Rose- doors 1-5/8" to 2-1/4" thick- Avail.w/24,25,26,28,29,30,36,37,38,39,40,41,43,45,50,51,52,57,58,67 functions	\$140.00
60	SARGENT Large Format Interchangeable Plastic Disposable Construction Core	No addition
63	SARGENT Large Format Interchangeable core cylinder, includes master keying charges	\$83.00 / cyl
64	SARGENT Large Format Interchangeable Construction Core Cylinder	\$83.00
6573▲†	Small Format 6-Pin Uncombined Core (Refer to CK-12)	\$65.00 / cyl.
65737P▲†	Small Format 7-Pin Uncombined Core (Refer to CK-12)	\$65.00 / cyl.
68	8200 Line furnished with lever handle outside x knob inside (Excludes SLD Detention Knob)	Defaults to 8200 Lever Lock Price
69	8200 Line furnished with lever handle inside x knob outside (Excludes SLD Detention Knob)	Defaults to 8200 Lever Lock Price
70▲†	Small Format interchangeable disposable plastic construction core	No addition
72▲†	Small Format interchangeable 6-Pin construction core	\$75.00
73▲†	Small Format interchangeable core 6-pin Includes MK and GMK keying charges	\$75.00 / cyl
737P▲†	Small Format interchangeable core 7-pin (refer to CK-12 for available keyways) Includes MK and GMK keying charges	\$75.00 / cyl
74	Lock case wrapped in lead - handing required (roses not available)	\$294.00
75	Tactile Warning - Milled Inside Lever	\$78.00
76	Tactile Warning - Milled Outside Lever	\$78.00
77	Tactile Warning - Milled Outside and Inside Lever	\$156.00
81▲†	Cylinder to accept Keso (83) and Keso F1 (F183) removable core - no core provided	No addition
F182†	SARGENT Keso Security Cylinder - patented - new key systems	\$91.00 / cyl.
F183▲†	SARGENT Keso Security Removable Core Cylinder - patented - new key systems	\$130.00 / cyl.
82†	SARGENT Keso Security Cylinder (For existing systems only)	\$91.00 / cyl.
83▲†	SARGENT Keso Security Removable Core Cylinder (For existing systems only)	\$130.00 / cyl.
84▲†	SARGENT Keso Security Removable Construction Core Cylinder	See CK-18
85	Tactile Warning - Abrasive Coating on Inside Lever	\$49.00
86	Tactile Warning - Abrasive Coating on Outside Lever	\$49.00
87	Tactile Warning - Abrasive Coating on Outside & Inside Lever	\$98.00
AV	Anti Vandal Pull Trim (available in 32D finish) (Not available with 8270, 8271, 8272, 8273 functions)	\$229.00
BR	SARGENT Bump Resistant Cylinders (N/A w/10, 22, 30, 60, 63, 64, 70, 72, 73, 737P, KESO, SC, & SE options)	\$25.00 /cyl.
DG1	Patented Degree DG1 Key System	No addition
DG160	Hardware prepared for DG1-6300 Lg. Format IC cores, supplied with temporary plastic construction cores	No addition
DG163	Patented Degree DG1 Large Format Interchangeable Core Cylinder - Includes master keying charges	\$83.00
DG164	Hardware prepared for DG1-6300 Lg. Format IC cores, supplied with temporary keyed construction cores	\$83.00
DG2	Patented Degree DG2 Key System incorporating a locking sidebar	\$63.00/cyl.
DG260	Hardware prepared for DG2-6300 Lg. Format IC cores, supplied with temporary plastic construction cores	No addition
DG263	Patented Degree DG2 Large Format Interchangeable Core Cylinder - Includes master keying charges	\$146.00
DG264	Hardware prepared for DG2-6300 Lg. Format IC cores, supplied with temporary keyed construction cores	\$83.00
DG3	Patented Degree DG3 Key System incorporating a locking sidebar and UL437 listed	\$89.00/cyl.
DG360	Hardware prepared for DG3-6300 Lg. Format IC cores, supplied with temporary plastic construction cores	No addition
DG363	Patented Degree DG3 Large Format Interchangeable Core Cylinder - Includes master keying charges	\$172.00
DG364	Hardware prepared for DG3-6300 Lg. Format IC cores, supplied with temporary keyed construction cores	\$83.00
IDP	Integrated Door Position Switch	\$108.00
LB	Extra large thumbturn	\$18.00
LC	Less Cylinder	-\$96.00/cyl.
OBS	Open Back Strike	\$79.00
PHR	Deadbolt Privacy Function (available w/deadbolt function only)	\$100.00
R01	Mercury and Lenel compatible 1KΩ/2KΩ resistance supervision	\$100.00
R03	Software House compatible 1KΩ/2KΩ resistance supervision	\$100.00
R04	AMAG compatible 4-state supervision	\$100.00
SC▲†	Schlage "C" Keyway cylinder, (Number 41 Cylinder Only, 0 bitted)	No addition
SE▲†	Schlage "E" Keyway cylinder, (Number 41 Cylinder Only, 0 bitted)	No addition
SG	MicroShield® - an antimicrobial powder coat finish	\$73.00
WBS	Wrought Box Strike	No addition
NOTES:	▲ Options not avail. with a standard 50 function lockout cylinder. † Not avail. with 60, 63, 64 options	
CPC	Clear Powder Coat over 26D/32D - NAC 82280-12V x LNA x RH x 32D x CPC All orders will continue to be handled as a "special" when CPC is ordered.	\$67.00

Experience a safer
and more open world

Copyright © 2002-2021 Sargent Manufacturing Company, an ASSA ABLOY Group company. All rights reserved.
Reproduction in whole or in part without the express written permission of Sargent Manufacturing Company is prohibited.
Contact us at: 800-727-5477 or visit www.sargentlock.com. In Canada contact us at: 800-461-3007 or visit www.assaabloydss.ca

SARGENT®

ASSA ABLOY

**For V Series
Indicators
Click / See
Page ML-1A**

Indicators only available with
NAC-82281 and NAC-82285
when used with PHR option.

ML-15 MORTISE LOCKS

NAC 8200 SERIES

USA & Canada Prices Effective May 1, 2021



LNJ

Rose: O, E, L, LN (Shown) Lever: J (Shown)

NAC 8200 Electrified Mortise Locks with High Security Monitoring				10BE/26D/ BSP/WSP	03/04/09/10/ 10B/10BL/14/15/ 20D/26/32/32D
Option	Function	Trim - Proximity Entry	Description		
NAC	82270-12V/-24V	Rose x Lever Design	Fail Safe w/Cylinder Override	\$1,362.00	\$1,513.00
NAC	82271-12V/-24V	Rose x Lever Design	Fail Secure w/Cylinder Override		
NAC	82280-12V/-24V	Rose x Lever Design	Fail Safe w/Deadbolt w/Cyl.Override	\$1,437.00	\$1,588.00
NAC	82281-12V/-24V	Rose x Lever Design	Fail Secure w/D.bolt w/Cyl.Override		
NAC	82274-12V/-24V	Rose x Lever Design	Fail Safe - No Cylinder	\$1,307.00	\$1,458.00
NAC	82275-12V/-24V	Rose x Lever Design	Fail Secure - No Cylinder		
NAC	82284-12V/-24V	Rose x Lever Design	Fail Safe w/Deadbolt - No Cylinder	\$1,382.00	\$1,533.00
NAC	82285-12V/-24V	Rose x Lever Design	Fail Secure w/Deadbolt - No Cylinder		

Note: Consult catalog for ordering information.

Specify hand and voltage (12v or 24v) when ordering

Experience a safer
and more open world

Copyright © 2002-2021 Sargent Manufacturing Company, an ASSA ABLOY Group company. All rights reserved.
Reproduction in whole or in part without the express written permission of Sargent Manufacturing Company is prohibited.
Contact us at: 800-727-5477 or visit www.sargentlock.com. In Canada contact us at: 800-461-3007 or visit www.assaabloydss.ca

ML-16 MORTISE LOCKS

**For V Series
Indicators
Click / See
Page ML-1A**

SARGENT®

ASSA ABLOY

OPTIONS

USA & Canada Prices Effective May 1, 2021

Options	Description	Price
1▲	8200 Line with 1-1/16" wide front for 1-3/8" doors.	\$62.00
3	Stainless steel hub (not available with 8289, 8291 & 8292 functions)	\$69.00
10▲	SARGENT Signature Key System	\$63.00 / cyl.
11†▲	SARGENT XC Key System (not available with 10, 22, SC, SE options)	No addition
1160	SARGENT XC Large Format Interchangeable Plastic Disposable Construction Core	No addition
1163	SARGENT XC Large Format Interchangeable Core Cylinder - Includes masterkeying charges	\$83.00
1164	SARGENT XC Large Format Interchangeable Construction Core Cylinder	\$83.00
1170	Small Format interchangeable disposable construction core - to accept 7 Pin XC permanent core	No addition
11727P	Small Format interchangeable keyed construction core - to accept 7 Pin XC permanent core	\$75.00
11737P	Small Format interchangeable core - to accept 7 pin XC permanent core	\$75.00 / cyl.
21▲†	SARGENT Construction Key System (lost ball) Standard on all new systems established since 5/1/96	\$16.00 / cyl.
22▲†	SARGENT Construction Key System (split key) To be used on pre-established split key systems only	\$32.00 / cyl.
23	Locksets with flat 4-7/8" ANSI strike	No addition
31	Thick Doors - Extended Lip Required - Specify Length C to E - Cylinders - IMPORTANT- See catalog 7800/8200 option page for cylinder limitations - Below charges DO NOT include additional charges for special cylinder requirements	No addition
	Doors up to 2-1/2" thick - lock centered	No addition
	Doors 2-5/8" to 6" thick OR doors 1-3/4" thick w/max 1" paneling one side. For example: Specify 1-3/4" door with panel (Side) on inside or outside	Non Keyed function \$50.00 Keyed function \$100.00
36	6 Lobe security head screws	\$24.00
37	Spanner head screws	\$17.00
60	SARGENT Large Format Interchangeable Plastic Disposable Construction Core	No addition
63	SARGENT Large Format Interchangeable core cylinder, includes master keying charges	\$83.00 / cyl.
64	SARGENT Large Format Interchangeable Construction Core Cylinder	\$83.00
6573▲†	Small Format 6-Pin Uncombined Core (Refer to CK-12)	\$65.00 / cyl.
65737P▲†	Small Format 7-Pin Uncombined Core (Refer to CK-12)	\$65.00 / cyl.
68	8200 Line furnished with lever handle outside x knob inside (Excludes SLD Detention Knob)	Defaults to 8200 Lever Lock Price
69	8200 Line furnished with lever handle inside x knob outside (Excludes SLD Detention Knob)	Defaults to 8200 Lever Lock Price
70▲†	Small Format Interchangeable disposable plastic construction core	No addition
72▲†	Small Format Interchangeable 6-pin construction core (7-pin with 11 option)	\$75.00
73▲†	Small Format interchangeable core 6-pin Includes MK and GMK keying charges	\$75.00 / cyl
737P▲†	Small Format interchangeable core 7-pin (refer to CK-12 for available keyways) Includes MK and GMK keying charges	\$75.00 / cyl
75	Tactile Warning - Milled Inside Lever (Not available with A lever)	\$78.00
76	Tactile Warning - Milled Outside Lever (Not available with A lever)	\$78.00
77	Tactile Warning - Milled Outside and Inside Lever (Not available with A lever)	\$156.00
81▲†	Cylinder to accept Keso (83) and Keso F1 (F183) removable core – no core provided	No addition
F182†	SARGENT Keso Security Cylinder – patented – new key systems	\$91.00 / cyl.
F183▲†	SARGENT Keso Security Removable Core Cylinder – patented – new key systems	\$130.00 / cyl.
82†	SARGENT Keso Security Cylinder (For existing systems only)	\$91.00 / cyl.
83▲†	SARGENT Keso Security Removable Core Cylinder (for existing systems only)	\$130.00 / cyl.
84▲†	SARGENT Keso Security Removable Construction Core Cylinder	See CK-18
85	Tactile Warning - Abrasive Coating on Inside Lever	\$49.00
86	Tactile Warning - Abrasive Coating on Outside Lever	\$49.00
87	Tactile Warning - Abrasive Coating on Outside & Inside Lever	\$98.00
AV	Anti Vandal Pull Trim (available in 32D finish), (Not available with 8270, 8271, 8272, 8273 functions)	\$229.00
BR	SARGENT Bump Resistant Cylinders (N/A w/10, 22, 30, 60, 63, 64, 70, 72, 73, 737P, KESO, SC, & SE options)	\$25.00 / cyl.
DG1	Patented Degree DG1 Key System	No addition
DG160	Hardware prepared for DG1-6300 Lg. Format IC cores, supplied with temporary plastic construction cores	No addition
DG163	Patented Degree DG1 Large Format Interchangeable Core Cylinder - Includes master keying charges	\$83.00
DG164	Hardware prepared for DG1-6300 Lg. Format IC cores, supplied with temporary keyed construction cores	\$83.00
DG2	Patented Degree DG2 Key System incorporating a locking sidebar	\$63.00/cyl.
DG260	Hardware prepared for DG2-6300 Lg. Format IC cores, supplied with temporary plastic construction cores	No addition
DG263	Patented Degree DG2 Large Format Interchangeable Core Cylinder - Includes master keying charges	\$146.00
DG264	Hardware prepared for DG2-6300 Lg. Format IC cores, supplied with temporary keyed construction cores	\$83.00
DG3	Patented Degree DG3 Key System incorporating a locking sidebar and UL437 listed	\$89.00/cyl.
DG360	Hardware prepared for DG3-6300 Lg. Format IC cores, supplied with temporary plastic construction cores	No addition
DG363	Patented Degree DG3 Large Format Interchangeable Core Cylinder - Includes master keying charges	\$172.00
DG364	Hardware prepared for DG3-6300 Lg. Format IC cores, supplied with temporary keyed construction cores	\$83.00
DX	Deadbolt Monitoring (not available with 50, 74)	\$197.00
LB	Extra large thumbturn	\$18.00
LC	Less Cylinder	-\$96.00/cyl.
LX	Latchbolt Monitor – available with all non-deadbolt functions; not available with DX option	\$200.00
OBS	Open Back Strike	\$79.00
RX	Request to Exit	\$206.00
SC▲†	Schlage "C" Keyway cylinder, (Number 41 Cylinder Only, 0 bitted)	No addition
SE▲†	Schlage "E" Keyway cylinder, (Number 41 Cylinder Only, 0 bitted)	No addition
SG	MicroShield® – an antimicrobial powder coat finish	\$73.00
WBS	Wrought Box Strike	No addition

NOTES: ▲ Options not avail. with a standard 50 function lockout cylinder. † Not avail. with 60, 63, 64 options

CPC Clear Powder Coat over 26D/32D – 8205 x LE1L x RH x 32D x CPC \$67.00
All orders will continue to be handled as a "special" when CPC is ordered.

Experience a safer
and more open world

Copyright © 2002-2021 Sargent Manufacturing Company, an ASSA ABLOY Group company. All rights reserved.
Reproduction in whole or in part without the express written permission of Sargent Manufacturing Company is prohibited.
Contact us at: 800-727-5477 or visit www.sargentlock.com. In Canada contact us at: 800-461-3007 or visit www.assaabloydss.ca

ASSA ABLOY

8200

USA & Canada
Prices Effective
May 1, 2021

LE1, VN1* Escutcheon Prices shown
LE2, LE3, LE4 Escutcheons – refer to below for add
• A-B-E-F-J-L-P-W Levers

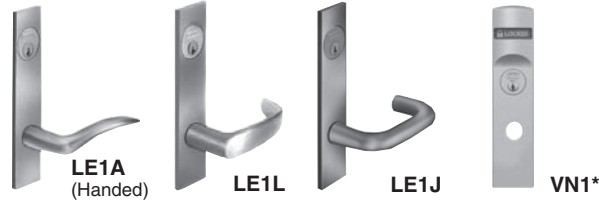

Function	Finish	
	10BE/26D/BSP/WSP	03/04/09/10/10B/10BL/14/15/20D/26/32/32D
Single Cyl		
8204 Storeroom or Closet		
8205 Office or Entry		
8237 Classroom	\$1,146.00	\$1,170.00
8255 Office or Entry		
8206 Storeroom or Service		
8231 Utility		
8236 Closet		
8256 Office or Inner Entry		
8257, 8258, 8267 Institutional Privacy	\$1,169.00	\$1,193.00
8289 Holdback		
8291 All Purpose Holdback		
Single Cyl With Deadbolt		
8224 Room Door		
8225 Dormitory or Exit		
8227 Closet or Storeroom		
8228, 8230 Dummy Trim Deadlock		
8235 Storeroom	\$1,201.00	\$1,225.00
8243 Apartment Corridor		
8245 Dormitory or Exit		
8247 Front Door or Apartment Corridor		
8251 Storeroom Deadbolt		
8250 Hotel Guest Lock	\$1,246.00	\$1,270.00
Double Cyl No Deadbolt		
8216 Apartment or Exit or Public Toilet		
8217 Asylum or Institutional		
8238 Classroom Security Intruder		
8242 Classroom Security Intruder Latchbolt	\$1,255.00	\$1,279.00
8259 School Security		
8290 Classroom Security Holdback		
8292 All Purpose Holdback		
Double Cyl With Deadbolt		
8226 Store Door		
8229 Dummy Trim Deadlock		
8239, 8240 Classroom Security Intruder		
8241 Classroom Security		
8246 Dormitory or Exit	\$1,283.00	\$1,307.00
8248 Store Door		
8249 Security Deadbolt		
8252 Institutional		
Electro Mechanical Single Cyl – Specify 12V or 24V		
8270-12V / 8270-24V Fail Safe		
8271-12V / 8271-24V Fail Secure	\$1,342.00	\$1,366.00
Electro Mechanical Double Cyl – Specify 12V or 24V		
8272-12V / 8272-24V Fail Safe		
8273-12V / 8273-24V Fail Secure	\$1,399.00	\$1,423.00
Non Keyed		
8213 Communication or Exit		
8215 Passage or Closet	\$917.00	\$941.00
8265 Privacy Bedroom or Bath (Latch)	\$1,024.00	\$1,048.00
8266, 8268 Privacy Bedroom or Bath (Deadbolt)	\$1,085.00	\$1,109.00
8293* Single Dummy Trim	\$379.00	\$391.00
8294 Double Dummy Trim	\$756.00	\$780.00
8295 Single Dummy Trim w/Lockbody	\$483.00	\$495.00
8296 Double Dummy Trim w/Lockbody	\$862.00	\$886.00
8297 Double Dummy Trim w/Active Trim	\$950.00	\$974.00

**A" Lever Only—Specify hand and if for inside or outside of door, when ordering.

Escutcheon Variations	Escutcheon	Description	Price
Standard Cylinder	LE2	x concealed mounting	\$32.00
Non-Keyed Function	LE2	x concealed mounting	\$32.00
Cylinder Barrel Only	LE3	x exposed screws (not avail. in double cyl. functions)	\$91.00 Set
Non-Keyed Function	LE3	x exposed screws	\$32.00
Cylinder Barrel Only	LE4	x concealed mounting (not avail. in double cyl. functions)	\$101.00
Non-Keyed Function	LE4	x concealed mounting	\$32.00

Experience a safer
and more open world

ML-18 MORTISE LOCKS

For V Series
Indicators
Click / See
Page ML-1A

SARGENT®

ASSA ABLOY

OPTIONS

USA & Canada Prices Effective May 1, 2021

Options	Description	Price
1▲	8200 Line with 1-1/16" wide front for 1-3/8" doors.	\$62.00
3	Stainless steel hub (not available with 8289, 8291 & 8292 functions)	\$69.00
10▲	SARGENT Signature Key System	\$63.00 / cyl.
11▲	SARGENT XC Key System (not available w/10, KESO, SC, SE)	No addition
1160	SARGENT XC Large Format Interchangeable Plastic Disposable Construction Core	No addition
1163	SARGENT XC Large Format Interchangeable Core Cylinder - Includes masterkeying charges	\$83.00
1164	SARGENT XC Large Format Interchangeable Construction Core Cylinder	\$83.00
1170	Small Format interchangeable disposable construction core - to accept 7 Pin XC permanent core	No addition
11727P	Small Format interchangeable keyed construction core - to accept 7 Pin XC permanent core	\$75.00
11737P	Small Format interchangeable core - to accept 7 pin XC permanent core	\$75.00 /cyl.
21▲†	SARGENT Construction Key System (lost ball) Standard on all new systems established since 5/1/96	\$16.00 / cyl.
22▲†	SARGENT Construction Key System (split key) To be used on pre-established split key systems only	\$32.00 / cyl.
23	Locksets with flat 4 7/8" ANSI strike	No addition
31	Thick Doors - Extended Lip Required - Specify Length C to E IMPORTANT: See 7800/8200 Catalog Option Page for Cylinder Limits – DOES NOT include additional Charges for Special Cylinder Requirements Doors up to 2-1/2" thick - lock centered • Doors 2-5/8" to 6" thick OR doors 1-3/4" thick w/max 1" paneling one side. For example: Specify 1-3/4" door with panel (Side) on inside or outside	No addition Non Keyed function \$50.00 Keyed function \$100.00
36	6 Lobe security head screws	\$24.00
37	Spanner head screws	\$17.00
60	SARGENT Large Format Interchangeable Plastic Disposable Construction Core	No addition
63	SARGENT Large Format Interchangeable core cylinder, includes master keying charges	\$83.00 / cyl
64	SARGENT Large Format Interchangeable Construction Core Cylinder	\$83.00
6573▲†	Small Format 6-Pin Uncombined Core (Refer to CK-12)	\$65.00 / cyl.
65737P▲†	Small Format 7-Pin Uncombined Core (Refer to CK-12)	\$65.00 / cyl.
68	8200 Line furnished with lever handle outside x knob inside (Excludes SLD Detention Knob)	Defaults to 8200 Lever Lock Price
69	8200 Line furnished with lever handle inside x knob outside (Excludes SLD Detention Knob)	Defaults to 8200 Lever Lock Price
70▲†	Small Format interchangeable disposable plastic construction core	No addition
72▲†	Small Format interchangeable 6-Pin construction core	\$75.00
73▲†	Small Format interchangeable core 6-pin Includes MK and GMK keying charges	\$75.00 / cyl
737P▲†	Small Format interchangeable core 7-pin (refer to CK-12 for available keyways) Includes MK and GMK keying charges	\$75.00 / cyl
75	Tactile Warning - Milled Inside Lever	\$78.00
76	Tactile Warning - Milled Outside Lever	\$78.00
77	Tactile Warning - Milled Outside and Inside Lever	\$156.00
81▲†	Cylinder to accept Keso (83) and Keso F1 (F183) removable core – no core provided	No addition
F182†	SARGENT Keso Security Cylinder – patented – new key systems	\$91.00 / cyl.
F183▲†	SARGENT Keso Security Removable Core Cylinder – patented – new key systems	\$130.00 / cyl.
82†	SARGENT Keso Security Cylinder (For existing systems only)	\$91.00 / cyl.
83▲†	SARGENT Keso Security Removable Core Cylinder (For existing systems only)	\$130.00 / cyl.
84▲†	SARGENT Keso Security Removable Construction Core Cylinder	See CK-18
85	Tactile Warning - Abrasive Coating on Inside Lever	\$49.00
86	Tactile Warning - Abrasive Coating on Outside Lever	\$49.00
87	Tactile Warning - Abrasive Coating on Outside & Inside Lever	\$98.00
AV	Anti Vandal Pull Trim (available in 32D finish), (Not available with 8270, 8271, 8272, 8273 functions)	\$229.00
BR	SARGENT Bump Resistant Cylinders (N/A w/10, 22, 30, 60, 63, 64, 70, 72, 73, 737P, KESO, SC, & SE options)	\$25.00 /cyl.
DG1	Patented Degree DG1 Key System	No addition
DG160	Hardware prepared for DG1-6300 Lg. Format IC cores, supplied with temporary plastic construction cores	No addition
DG163	Patented Degree DG1 Large Format Interchangeable Core Cylinder - Includes master keying charges	\$83.00
DG164	Hardware prepared for DG1-6300 Lg. Format IC cores, supplied with temporary keyed construction cores	\$83.00
DG2	Patented Degree DG2 Key System incorporating a locking sidebar	\$63.00/cyl.
DG260	Hardware prepared for DG2-6300 Lg. Format IC cores, supplied with temporary plastic construction cores	No addition
DG263	Patented Degree DG2 Large Format Interchangeable Core Cylinder - Includes master keying charges	\$146.00
DG264	Hardware prepared for DG2-6300 Lg. Format IC cores, supplied with temporary keyed construction cores	\$83.00
DG3	Patented Degree DG3 Key System incorporating a locking sidebar and UL437 listed	\$89.00/cyl.
DG360	Hardware prepared for DG3-6300 Lg. Format IC cores, supplied with temporary plastic construction cores	No addition
DG363	Patented Degree DG3 Large Format Interchangeable Core Cylinder - Includes master keying charges	\$172.00
DG364	Hardware prepared for DG3-6300 Lg. Format IC cores, supplied with temporary keyed construction cores	\$83.00
IDP	Integrated Door Position Switch	\$108.00
LB	Extra large thumbturn	\$18.00
LC	Less Cylinder	-\$96.00/cyl.
OBS	Open Back Strike	\$79.00
PHR	Deadbolt Privacy Function (available w/deadbolt function only)	\$100.00
R01	Mercury and Lenel compatible 1KΩ/2KΩ resistance supervision	\$100.00
R03	Software House compatible 1KΩ/2KΩ resistance supervision	\$100.00
R04	AMAG compatible 4-state supervision	\$100.00
SC▲†	Schlage "C" Keyway cylinder, (Number 41 Cylinder Only, 0 bitted)	No addition
SE▲†	Schlage "E" Keyway cylinder, (Number 41 Cylinder Only, 0 bitted)	No addition
SG	MicroShield® – an antimicrobial powder coat finish	\$73.00
WBS	Wrought Box Strike	No addition
NOTES: ▲ Options not avail. with a standard 50 function lockout cylinder. † Not avail. with 60, 63, 64 options		
CPC	Clear Powder Coat over 26D/32D – NAC 82280-24V x LE1A x RH x 32D x CPC All orders will continue to be handled as a "special" when CPC is ordered.	\$67.00

Experience a safer
and more open world

Copyright © 2002-2021 Sargent Manufacturing Company, an ASSA ABLOY Group company. All rights reserved.
Reproduction in whole or in part without the express written permission of Sargent Manufacturing Company is prohibited.
Contact us at: 800-727-5477 or visit www.sargentlock.com. In Canada contact us at: 800-461-3007 or visit www.assaabloydss.ca

USA & Canada Prices Effective May 1, 2021

LE1, VN1* Escutcheon Prices shown
LE2, LE3, LE4 Escutcheons – refer to ML-17 for add
• A-B-E-F-J-L-P-W Levers



NAC 8200 Electrified Mortise Locks with High Security Monitoring				10BE/26D/ BSP/WSP	03/04/09/10/ 10B/10BL/14/15/ 20D/26/32/32D
Option	Function	Trim - Proximity Entry	Description		
NAC	82270-12V/-24V	Rose x Lever Design	Fail Safe w/Cylinder Override	\$1,517.00	\$1,541.00
NAC	82271-12V/-24V	Rose x Lever Design	Fail Secure w/Cylinder Override		
NAC	82280-12V/-24V	Rose x Lever Design	Fail Safe w/Deadbolt w/Cyl.Override	\$1,592.00	\$1,616.00
NAC	82281-12V/-24V	Rose x Lever Design	Fail Secure w/D.bolt w/Cyl.Override		
NAC	82274-12V/-24V	Rose x Lever Design	Fail Safe - No Cylinder	\$1,462.00	\$1,486.00
NAC	82275-12V/-24V	Rose x Lever Design	Fail Secure - No Cylinder		
NAC	82284-12V/-24V	Rose x Lever Design	Fail Safe w/Deadbolt - No Cylinder	\$1,537.00	\$1,561.00
NAC	82285-12V/-24V	Rose x Lever Design	Fail Secure w/Deadbolt - No Cylinder		

Note: Consult catalog for ordering information.
Specify hand and voltage (12v or 24v) when ordering

ML-20 MORTISE LOCKS

SARGENT®

ASSA ABLOY

OPTIONS

USA & Canada Prices Effective May 1, 2021

Options	Description	Price
1▲	8200 Line with 1-1/16" wide front for 1-3/8" doors.	\$62.00
3	Stainless steel hub (not available with 8289, 8291 & 8292 functions)	\$69.00
10▲	SARGENT Signature Key System	\$63.00 / cyl.
11†▲	SARGENT XC Key System (not available with 10, 22, SC, SE options)	No addition
1160	SARGENT XC Large Format Interchangeable Plastic Disposable Construction Core	No addition
1163	SARGENT XC Large Format Interchangeable Core Cylinder - Includes masterkeying charges	\$83.00
1164	SARGENT XC Large Format Interchangeable Construction Core Cylinder	\$83.00
1170	Small Format interchangeable disposable construction core - to accept 7 Pin XC permanent core	No addition
11727P	Small Format interchangeable keyed construction core - to accept 7 Pin XC permanent core	\$75.00
11737P	Small Format interchangeable core - to accept 7 pin XC permanent core	\$75.00 /cyl.
21▲†	SARGENT Construction Key System (lost ball) Standard on all new systems established since 5/1/96	\$16.00 / cyl.
22▲†	SARGENT Construction Key System (split key) To be used on pre-established split key systems only	\$32.00 / cyl.
23	Locksets with flat 4-7/8" ANSI strike	No addition
31	Thick Doors - Extended Lip Required - Specify Length C to E - Cylinders - IMPORTANT- See catalog 7800/8200 option page for cylinder limitations - Below charges DO NOT include additional charges for special cylinder requirements Doors up to 2-1/2" thick - lock centered Doors 2-5/8" to 6" thick OR doors 1-3/4" thick w/max 1" paneling one side. For example: Specify 1-3/4" door with panel (Side) on inside or outside	No addition Non Keyed function \$50.00 Keyed function \$100.00
36	6 Lobe security head screws	\$24.00
37	Spanner head screws	\$17.00
60	SARGENT Large Format Interchangeable Plastic Disposable Construction Core	No addition
63	SARGENT Large Format Interchangeable core cylinder, includes master keying charges	\$83.00 / cyl.
64	SARGENT Large Format Interchangeable Construction Core Cylinder	\$83.00
6573▲†	Small Format 6-Pin Uncombined Core (Refer to CK-12)	\$65.00 / cyl.
65737P▲†	Small Format 7-Pin Uncombined Core (Refer to CK-12)	\$65.00 / cyl.
68	8200 Line furnished with lever handle outside x knob inside (Excludes SLD Detention Knob)	Defaults to 8200 Lever Lock Price
69	8200 Line furnished with lever handle inside x knob outside (Excludes SLD Detention Knob)	Defaults to 8200 Lever Lock Price
70▲†	Small Format Interchangeable disposable plastic construction core	No addition
72▲†	Small Format Interchangeable 6-pin construction core (7-pin with 11 option)	\$75.00
73▲†	Small Format interchangeable core 6-pin Includes MK and GMK keying charges	\$75.00 / cyl
737P▲†	Small Format interchangeable core 7-pin (refer to CK-12 for available keyways) Includes MK and GMK keying charges	\$75.00 / cyl
75	Tactile Warning - Milled Inside Lever (Not available with A lever)	\$78.00
76	Tactile Warning - Milled Outside Lever (Not available with A lever)	\$78.00
77	Tactile Warning - Milled Outside and Inside Lever (Not available with A lever)	\$156.00
81▲†	Cylinder to accept Keso (83) and Keso F1 (F183) removable core – no core provided	No addition
F182†	SARGENT Keso Security Cylinder – patented – new key systems	\$91.00 / cyl.
F183▲†	SARGENT Keso Security Removable Core Cylinder – patented – new key systems	\$130.00 / cyl.
82†	SARGENT Keso Security Cylinder (For existing systems only)	\$91.00 / cyl.
83▲†	SARGENT Keso Security Removable Core Cylinder (For existing systems only)	\$130.00 / cyl.
84▲†	SARGENT Keso Security Removable Construction Core Cylinder	See CK-18
85	Tactile Warning - Abrasive Coating on Inside Lever	\$49.00
86	Tactile Warning - Abrasive Coating on Outside Lever	\$49.00
87	Tactile Warning - Abrasive Coating on Outside & Inside Lever	\$98.00
AV	Anti Vandal Pull Trim (available in 32D finish), (Not available with 8270, 8271, 8272, 8273 functions)	\$229.00
BR	SARGENT Bump Resistant Cylinders (N/A w/10, 22, 30, 60, 63, 64, 70, 72, 73, 737P, KESO, SC, & SE options)	\$25.00 /cyl.
DG1	Patented Degree DG1 Key System	No addition
DG160	Hardware prepared for DG1-6300 Lg. Format IC cores, supplied with temporary plastic construction cores	No addition
DG163	Patented Degree DG1 Large Format Interchangeable Core Cylinder - Includes master keying charges	\$83.00
DG164	Hardware prepared for DG1-6300 Lg. Format IC cores, supplied with temporary keyed construction cores	\$83.00
DG2	Patented Degree DG2 Key System incorporating a locking sidebar	\$63.00/cyl.
DG260	Hardware prepared for DG2-6300 Lg. Format IC cores, supplied with temporary plastic construction cores	No addition
DG263	Patented Degree DG2 Large Format Interchangeable Core Cylinder - Includes master keying charges	\$146.00
DG264	Hardware prepared for DG2-6300 Lg. Format IC cores, supplied with temporary keyed construction cores	\$83.00
DG3	Patented Degree DG3 Key System incorporating a locking sidebar and UL437 listed	\$89.00/cyl.
DG360	Hardware prepared for DG3-6300 Lg. Format IC cores, supplied with temporary plastic construction cores	No addition
DG363	Patented Degree DG3 Large Format Interchangeable Core Cylinder - Includes master keying charges	\$172.00
DG364	Hardware prepared for DG3-6300 Lg. Format IC cores, supplied with temporary keyed construction cores	\$83.00
DX	Deadbolt Monitoring (not available with 50, 74)	\$197.00
LB	Extra large thumbturn	\$18.00
LC	Less Cylinder	-\$96.00/cyl.
LX	Latchbolt Monitor – available with all non-deadbolt functions; not available with DX option	\$200.00
OBS	Open Back Strike	\$79.00
RX	Request to Exit	\$206.00
SC▲†	Schlage "C" Keyway cylinder, (Number 41 Cylinder Only, 0 bitted)	No addition
SE▲†	Schlage "E" Keyway cylinder, (Number 41 Cylinder Only, 0 bitted)	No addition
SG	MicroShield® – an antimicrobial powder coat finish	\$73.00
WBS	Wrought Box Strike	No addition

NOTES: ▲ Options not avail. with a standard 50 function lockout cylinder. † Not avail. with 60, 63, 64 options

CPC	Clear Powder Coat over 26D/32D – 8205 x LW1L x RH x 32D x CPC All orders will continue to be handled as a "special" when CPC is ordered.	\$67.00
-----	---	---------

Experience a safer
and more open world

Copyright © 2002-2021 Sargent Manufacturing Company, an ASSA ABLOY Group company. All rights reserved.
Reproduction in whole or in part without the express written permission of Sargent Manufacturing Company is prohibited.
Contact us at: 800-727-5477 or visit www.sargentlock.com. In Canada contact us at: 800-461-3007 or visit www.assaabloydss.ca

ASSA ABLOY

8200

USA & Canada
Prices Effective
May 1, 2021

LW1 Escutcheon
• A-B-E-F-J-L-P-W Levers



Function		Finish	
		10BE/26D/BSP/WSP	03/04/09/10/10B/10BL/14/15/20D/26/32/32D
Single Cyl			
8204	Storeroom or Closet		
8205	Office or Entry		
8237	Classroom	\$1,097.00	\$1,121.00
8255	Office or Entry		
8206	Storeroom or Service		
8231	Utility		
8236	Closet	\$1,123.00	\$1,147.00
8256	Office or Inner Entry		
8257, 8258, 8267	Institutional Privacy		
8289	Holdback		
8291	All Purpose Holdback		
Single Cyl With Deadbolt			
8224	Room Door		
8225	Dormitory or Exit		
8227	Closet or Storeroom		
8228, 8230	Dummy Trim Deadlock		
8235	Storeroom	\$1,154.00	\$1,178.00
8243	Apartment Corridor		
8245	Dormitory or Exit		
8247	Front Door or Apartment Corridor		
8251	Storeroom Deadbolt		
8250	Hotel Guest Lock	\$1,192.00	\$1,216.00
Double Cyl No Deadbolt			
8216	Apartment or Exit or Public Toilet		
8217	Asylum or Institutional		
8238	Classroom Security Intruder		
8242	Classroom Security Intruder Latchbolt	\$1,212.00	\$1,236.00
8259	School Security		
8290	Classroom Security Holdback		
8292	All Purpose Holdback		
Double Cyl With Deadbolt			
8226	Store Door		
8229	Dummy Trim Deadlock		
8239, 8240	Classroom Security Intruder		
8241	Classroom Security	\$1,235.00	\$1,259.00
8246	Dormitory or Exit		
8248	Store Door		
8249	Security Deadbolt		
8252	Institutional		
Electro Mechanical Single Cyl – Specify 12V or 24V			
8270-12V / 8270-24V	Fail Safe	\$1,293.00	\$1,317.00
8271-12V / 8271-24V	Fail Secure		
Electro Mechanical Double Cyl – Specify 12V or 24V			
8272-12V / 8272-24V	Fail Safe	\$1,350.00	\$1,374.00
8273-12V / 8273-24V	Fail Secure		
Non Keyed			
8213	Communication or Exit	\$900.00	\$924.00
8215	Passage or Closet		
8265	Privacy Bedroom or Bath (Latch)	\$993.00	\$1,017.00
8266, 8268	Privacy Bedroom or Bath (Deadbolt)	\$1,058.00	\$1,082.00
8293*	Single Dummy Trim	\$348.00	\$360.00
8294	Double Dummy Trim	\$706.00	\$730.00
8295	Single Dummy Trim w/Lockbody	\$458.00	\$470.00
8296	Double Dummy Trim w/Lockbody	\$813.00	\$837.00
8297	Double Dummy w/Active Trim	\$900.00	\$924.00

*“A” Lever Only—Specify hand and if for inside or outside of door, when ordering.

Experience a safer
and more open world

Copyright © 2002-2021 Sargent Manufacturing Company, an ASSA ABLOY Group company. All rights reserved.
Reproduction in whole or in part without the express written permission of Sargent Manufacturing Company is prohibited.
Contact us at: 800-727-5477 or visit www.sargentlock.com. In Canada contact us at: 800-461-3007 or visit www.assaabloydss.ca

ML-22 MORTISE LOCKS

SARGENT®

ASSA ABLOY

OPTIONS

USA & Canada Prices Effective May 1, 2021

Options	Description	Price
1▲	8200 Line with 1-1/16" wide front for 1-3/8" doors.	\$62.00
3	Stainless steel hub (not available with 8289, 8291 & 8292 functions)	\$69.00
10▲	SARGENT Signature Key System	\$63.00 / cyl.
11†▲	SARGENT XC Key System (not available w/10, KESO, SC, SE)	No addition
1160	SARGENT XC Large Format Interchangeable Plastic Disposable Construction Core	No addition
1163	SARGENT XC Large Format Interchangeable Core Cylinder - Includes masterkeying charges	\$83.00
1164	SARGENT XC Large Format Interchangeable Construction Core Cylinder	\$83.00
1170	Small Format interchangeable disposable construction core - to accept 7 Pin XC permanent core	No addition
11727P	Small Format interchangeable keyed construction core - to accept 7 Pin XC permanent core	\$75.00
11737P	Small Format interchangeable core - to accept 7 pin XC permanent core	\$75.00 /cyl.
21▲†	SARGENT Construction Key System (lost ball) Standard on all new systems established since 5/1/96	\$16.00 / cyl.
22▲†	SARGENT Construction Key System (split key) To be used on pre-established split key systems only	\$32.00 / cyl.
23	Locksets with flat 4 7/8" ANSI strike	No addition
31	Thick Doors - Extended Lip Required - Specify Length C to E IMPORTANT: See 7800/8200 Catalog Option Page for Cylinder Limits – DOES NOT include additional Charges for Special Cylinder Requirements	No addition
	Doors up to 2-1/2" thick - lock centered • Doors 2-5/8" to 6" thick OR doors 1-3/4" thick w/max 1" paneling one side. For example: Specify 1-3/4" door with panel (Side) on inside or outside	Non Keyed function \$50.00 Keyed function \$100.00
36	6 Lobe security head screws	\$24.00
37	Spanner head screws	\$17.00
60	SARGENT Large Format Interchangeable Plastic Disposable Construction Core	No addition
63	SARGENT Large Format Interchangeable core cylinder, includes master keying charges	\$83.00 / cyl
64	SARGENT Large Format Interchangeable Construction Core Cylinder	\$83.00
6573▲†	Small Format 6-Pin Uncombined Core (Refer to CK-12)	\$65.00 / cyl.
65737P▲†	Small Format 7-Pin Uncombined Core (Refer to CK-12)	\$65.00 / cyl.
68	8200 Line furnished with lever handle outside x knob inside (Excludes SLD Detention Knob)	Defaults to 8200 Lever Lock Price
69	8200 Line furnished with lever handle inside x knob outside (Excludes SLD Detention Knob)	Defaults to 8200 Lever Lock Price
70▲†	Small Format interchangeable disposable plastic construction core	No addition
72▲†	Small Format interchangeable 6-Pin construction core	\$75.00
73▲†	Small Format interchangeable core 6-pin Includes MK and GMK keying charges	\$75.00 / cyl
737P▲†	Small Format interchangeable core 7-pin (refer to CK-12 for available keyways) Includes MK and GMK keying charges	\$75.00 / cyl
75	Tactile Warning - Milled Inside Lever	\$78.00
76	Tactile Warning - Milled Outside Lever	\$78.00
77	Tactile Warning - Milled Outside and Inside Lever	\$156.00
81▲†	Cylinder to accept Keso (83) and Keso F1 (F183) removable core – no core provided	No addition
F182†	SARGENT Keso Security Cylinder – patented – new key systems	\$91.00 / cyl.
F183▲†	SARGENT Keso Security Removable Core Cylinder – patented – new key systems	\$130.00 / cyl.
82†	SARGENT Keso Security Cylinder (For existing systems only)	\$91.00 / cyl.
83▲†	SARGENT Keso Security Removable Core Cylinder (For existing systems only)	\$130.00 / cyl.
84▲†	SARGENT Keso Security Removable Construction Core Cylinder	See CK-18
85	Tactile Warning - Abrasive Coating on Inside Lever	\$49.00
86	Tactile Warning - Abrasive Coating on Outside Lever	\$49.00
87	Tactile Warning - Abrasive Coating on Outside & Inside Lever	\$98.00
AV	Anti Vandal Pull Trim (available in 32D finish), (Not available with 8270, 8271, 8272, 8273 functions)	\$229.00
BR	SARGENT Bump Resistant Cylinders (N/A w/10, 22, 30, 60, 63, 64, 70, 72, 73, 737P, KESO, SC, & SE options)	\$25.00 /cyl.
DG1	Patented Degree DG1 Key System	No addition
DG160	Hardware prepared for DG1-6300 Lg. Format IC cores, supplied with temporary plastic construction cores	No addition
DG163	Patented Degree DG1 Large Format Interchangeable Core Cylinder - Includes master keying charges	\$83.00
DG164	Hardware prepared for DG1-6300 Lg. Format IC cores, supplied with temporary keyed construction cores	\$83.00
DG2	Patented Degree DG2 Key System incorporating a locking sidebar	\$63.00/cyl.
DG260	Hardware prepared for DG2-6300 Lg. Format IC cores, supplied with temporary plastic construction cores	No addition
DG263	Patented Degree DG2 Large Format Interchangeable Core Cylinder - Includes master keying charges	\$146.00
DG264	Hardware prepared for DG2-6300 Lg. Format IC cores, supplied with temporary keyed construction cores	\$83.00
DG3	Patented Degree DG3 Key System incorporating a locking sidebar and UL437 listed	\$89.00/cyl.
DG360	Hardware prepared for DG3-6300 Lg. Format IC cores, supplied with temporary plastic construction cores	No addition
DG363	Patented Degree DG3 Large Format Interchangeable Core Cylinder - Includes master keying charges	\$172.00
DG364	Hardware prepared for DG3-6300 Lg. Format IC cores, supplied with temporary keyed construction cores	\$83.00
IDP	Integrated Door Position Switch	\$108.00
LB	Extra large thumbturn	\$18.00
LC	Less Cylinder	-\$96.00/cyl.
OBS	Open Back Strike	\$79.00
PHR	Deadbolt Privacy Function (available w/deadbolt function only)	\$100.00
R01	Mercury and Lenel compatible 1KΩ/2KΩ resistance supervision	\$100.00
R03	Software House compatible 1KΩ/2KΩ resistance supervision	\$100.00
R04	AMAG compatible 4-state supervision	\$100.00
SC▲†	Schlage "C" Keyway cylinder, (Number 41 Cylinder Only, 0 bitting)	No addition
SE▲†	Schlage "E" Keyway cylinder, (Number 41 Cylinder Only, 0 bitting)	No addition
SG	MicroShield® – an antimicrobial powder coat finish	\$73.00
WBS	Wrought Box Strike	No addition
NOTES:	▲ Options not avail. with a standard 50 function lockout cylinder. † Not avail. with 60, 63, 64 options	
CPC	Clear Powder Coat over 26D/32D – NAC-82280-24V x LW1A x RH x 32D x CPC All orders will continue to be handled as a "special" when CPC is ordered.	\$67.00

Experience a safer
and more open world

Copyright © 2002-2021 Sargent Manufacturing Company, an ASSA ABLOY Group company. All rights reserved.
Reproduction in whole or in part without the express written permission of Sargent Manufacturing Company is prohibited.
Contact us at: 800-727-5477 or visit www.sargentlock.com. In Canada contact us at: 800-461-3007 or visit www.assaabloydss.ca

USA & Canada Prices Effective May 1, 2021

LW1 Escutcheon
• A-B-E-F-J-L-P-W Levers



NAC 8200 Electrified Mortise Locks with High Security Monitoring				10BE/26D/ BSP/WSP	03/04/09/10/ 10B/10BL/14/15/ 20D/26/32/32D
Option	Function	Trim - Proximity Entry	Description		
NAC	82270-12V/-24V	Rose x Lever Design	Fail Safe w/Cylinder Override	\$1,468.00	\$1,492.00
NAC	82271-12V/-24V	Rose x Lever Design	Fail Secure w/Cylinder Override		
NAC	82280-12V/-24V	Rose x Lever Design	Fail Safe w/Deadbolt w/Cyl.Override	\$1,543.00	\$1,567.00
NAC	82281-12V/-24V	Rose x Lever Design	Fail Secure w/D.bolt w/Cyl.Override		
NAC	82274-12V/-24V	Rose x Lever Design	Fail Safe - No Cylinder	\$1,413.00	\$1,437.00
NAC	82275-12V/-24V	Rose x Lever Design	Fail Secure - No Cylinder		
NAC	82284-12V/-24V	Rose x Lever Design	Fail Safe w/Deadbolt - No Cylinder	\$1,488.00	\$1,512.00
NAC	82285-12V/-24V	Rose x Lever Design	Fail Secure w/Deadbolt - No Cylinder		

Note: Consult catalog for ordering information.
Specify hand and voltage (12v or 24v) when ordering

ML-24 MORTISE LOCKS

SARGENT®

ASSA ABLOY

OPTIONS

USA & Canada Prices Effective May 1, 2021

Options	Description	Price
1▲	8200 Line with 1-1/16" wide front for 1-3/8" doors.	\$62.00
3	Stainless steel hub (not available with 8289, 8291 & 8292 functions)	\$69.00
10▲	SARGENT Signature Key System	\$63.00 / cyl.
11†▲	SARGENT XC Key System (not available with 10, 22, SC, SE options)	No addition
1160	SARGENT XC Large Format Interchangeable Plastic Disposable Construction Core	No addition
1163	SARGENT XC Large Format Interchangeable Core Cylinder - Includes masterkeying charges	\$83.00
1164	SARGENT XC Large Format Interchangeable Construction Core Cylinder	\$83.00
1170	Small Format interchangeable disposable construction core - to accept 7 Pin XC permanent core	No addition
11727P	Small Format interchangeable keyed construction core - to accept 7 Pin XC permanent core	\$75.00
11737P	Small Format interchangeable core - to accept 7 pin XC permanent core	\$75.00 / cyl.
21▲†	SARGENT Construction Key System (lost ball) Standard on all new systems established since 5/1/96	\$16.00 / cyl.
22▲†	SARGENT Construction Key System (split key) To be used on pre-established split key systems only	\$32.00 / cyl.
23	Locksets with flat 4-7/8" ANSI strike	No addition
31	Thick Doors - Extended Lip Required - Specify Length C to E - Cylinders - IMPORTANT- See catalog 7800/8200 option page for cylinder limitations - Below charges DO NOT include additional charges for special cylinder requirements Doors up to 2-1/2" thick - lock centered Doors 2-5/8" to 6" thick OR doors 1-3/4" thick w/max 1" paneling one side. For example: Specify 1-3/4" door with panel (Side) on inside or outside	No addition Non Keyed function \$50.00 Keyed function \$100.00
36	6 Lobe security head screws	\$24.00
37	Spanner head screws	\$17.00
60	SARGENT Large Format Interchangeable Plastic Disposable Construction Core	No addition
63	SARGENT Large Format Interchangeable core cylinder, includes master keying charges	\$83.00 / cyl.
64	SARGENT Large Format Interchangeable Construction Core Cylinder	\$83.00
6573▲†	Small Format 6-Pin Uncombined Core (Refer to CK-12)	\$65.00 / cyl.
65737P▲†	Small Format 7-Pin Uncombined Core (Refer to CK-12)	\$65.00 / cyl.
68	8200 Line furnished with lever handle outside x knob inside (Excludes SLD Detention Knob)	Defaults to 8200 Lever Lock Price
69	8200 Line furnished with lever handle inside x knob outside (Excludes SLD Detention Knob)	Defaults to 8200 Lever Lock Price
70▲†	Small Format interchangeable disposable plastic construction core	No addition
72▲†	Small Format Interchangeable 6-pin construction core (7-pin with 11 option)	\$75.00
73▲†	Small Format interchangeable core 6-pin Includes MK and GMK keying charges	\$75.00 / cyl
737P▲†	Small Format interchangeable core 7-pin (refer to CK-12 for available keyways) Includes MK and GMK keying charges	\$75.00 / cyl
75	Tactile Warning - Milled Inside Lever (Not available with A lever)	\$78.00
76	Tactile Warning - Milled Outside Lever (Not available with A lever)	\$78.00
77	Tactile Warning - Milled Outside and Inside Lever (Not available with A lever)	\$156.00
81▲†	Cylinder to accept Keso (83) and Keso F1 (F183) removable core – no core provided	No addition
F182†	SARGENT Keso Security Cylinder – patented – new key systems	\$91.00 / cyl.
F183▲†	SARGENT Keso Security Removable Core Cylinder – patented – new key systems	\$130.00 / cyl.
82†	SARGENT Keso Security Cylinder (For existing systems only)	\$91.00 / cyl.
83▲†	SARGENT Keso Security Removable Core Cylinder (For existing systems only)	\$130.00 cyl.
84▲†	SARGENT Keso Security Removable Construction Core Cylinder	See CK-18
85	Tactile Warning - Abrasive Coating on Inside Lever	\$49.00
86	Tactile Warning - Abrasive Coating on Outside Lever	\$49.00
87	Tactile Warning - Abrasive Coating on Outside & Inside Lever	\$98.00
AV	Anti Vandal Pull Trim (available in 32D finish), (Not available with 8270, 8271, 8272, 8273 functions)	\$229.00
BR	SARGENT Bump Resistant Cylinders (N/A w/10, 22, 30, 60, 63, 64, 70, 72, 73, 737P, KESO, SC, & SE options)	\$25.00 /cyl.
DG1	Patented Degree DG1 Key System	No addition
DG160	Hardware prepared for DG1-6300 Lg. Format IC cores, supplied with temporary plastic construction cores	No addition
DG163	Patented Degree DG1 Large Format Interchangeable Core Cylinder - Includes master keying charges	\$83.00
DG164	Hardware prepared for DG1-6300 Lg. Format IC cores, supplied with temporary keyed construction cores	\$83.00
DG2	Patented Degree DG2 Key System incorporating a locking sidebar	\$63.00/cyl.
DG260	Hardware prepared for DG2-6300 Lg. Format IC cores, supplied with temporary plastic construction cores	No addition
DG263	Patented Degree DG2 Large Format Interchangeable Core Cylinder - Includes master keying charges	\$146.00
DG264	Hardware prepared for DG2-6300 Lg. Format IC cores, supplied with temporary keyed construction cores	\$83.00
DG3	Patented Degree DG3 Key System incorporating a locking sidebar and UL437 listed	\$89.00/cyl.
DG360	Hardware prepared for DG3-6300 Lg. Format IC cores, supplied with temporary plastic construction cores	No addition
DG363	Patented Degree DG3 Large Format Interchangeable Core Cylinder - Includes master keying charges	\$172.00
DG364	Hardware prepared for DG3-6300 Lg. Format IC cores, supplied with temporary keyed construction cores	\$83.00
DX	Deadbolt Monitoring (not available with 50, 74)	\$197.00
LB	Extra large thumbturn	\$18.00
LC	Less Cylinder	-\$96.00/cyl.
LX	Latchbolt Monitor – available with all non-deadbolt functions; not available with DX option	\$200.00
OBS	Open Back Strike	\$79.00
RX	Request to Exit	\$206.00
SC▲†	Schlage "C" Keyway cylinder, (Number 41 Cylinder Only, 0 bitted)	No addition
SE▲†	Schlage "E" Keyway cylinder, (Number 41 Cylinder Only, 0 bitted)	No addition
SG	MicroShield® – an antimicrobial powder coat finish	\$73.00
TL	SARGuide™ – Illuminated escutcheon – refer to catalog for function limitations – not available w/RX & DX option	\$232.00
WBS	Wrought Box Strike	No addition

NOTES: ▲ Options not avail. with a standard 50 function lockout cylinder. † Not avail. with 60, 63, 64 options

CPC	Clear Powder Coat over 26D/32D – 8205 x WTL x RH x 32D x CPC All orders will continue to be handled as a "special" when CPC is ordered.	\$67.00
-----	--	---------

Experience a safer
and more open world

Copyright © 2002-2021 Sargent Manufacturing Company, an ASSA ABLOY Group company. All rights reserved.
Reproduction in whole or in part without the express written permission of Sargent Manufacturing Company is prohibited.
Contact us at: 800-727-5477 or visit www.sargentlock.com. In Canada contact us at: 800-461-3007 or visit www.assaabloydss.ca

WT Escutcheon
• A-B-E-F-J-L-P-W Levers



Function		Finish	
Single Cyl		10BE/26D/BSP/WSP	03/04/09/10/10B/10BL/14/15/20D/26/32/32D
8204	Storeroom or Closet		
8205	Office or Entry		
8237	Classroom	\$1,029.00	\$1,053.00
8255	Office or Entry		
8206	Storeroom or Service		
8231	Utility		
8236	Closet		
8256	Office or Inner Entry	\$1,053.00	\$1,077.00
8257, 8258, 8267	Institutional Privacy		
8289	Holdback		
8291	All Purpose Holdback		
Single Cyl With Deadbolt			
8224	Room Door		
8225	Dormitory or Exit		
8227	Closet or Storeroom		
8228, 8230	Dummy Trim Deadlock		
8235	Storeroom	\$1,085.00	\$1,109.00
8243	Apartment Corridor		
8245	Dormitory or Exit		
8247	Front Door or Apartment Corridor		
8251	Storeroom Deadbolt		
8250	Hotel Guest Lock	\$1,126.00	\$1,150.00
Double Cyl No Deadbolt			
8216	Apartment or Exit or Public Toilet		
8217	Asylum or Institutional		
8238	Classroom Security Intruder		
8242	Classroom Security Intruder Latchbolt	\$1,138.00	\$1,162.00
8259	School Security		
8290	Classroom Security Holdback		
8292	All Purpose Holdback		
Double Cyl With Deadbolt			
8226	Store Door		
8229	Dummy Trim Deadlock		
8239, 8240	Classroom Security Intruder		
8241	Classroom Security	\$1,163.00	\$1,187.00
8246	Dormitory or Exit		
8248	Store Door		
8249	Security Deadbolt		
8252	Institutional		
Electro Mechanical Single Cyl – Specify 12V or 24V			
8270-12V / 8270-24V	Fail Safe	\$1,225.00	\$1,249.00
8271-12V / 8271-24V	Fail Secure		
Electro Mechanical Double Cyl – Specify 12V or 24V			
8272-12V / 8272-24V	Fail Safe	\$1,282.00	\$1,306.00
8273-12V / 8273-24V	Fail Secure		
Non Keyed			
8213	Communication or Exit	\$847.00	\$871.00
8215	Passage or Closet		
8265	Privacy Bedroom or Bath (Latch)	\$956.00	\$980.00
8266, 8268	Privacy Bedroom or Bath (Deadbolt)	\$1,017.00	\$1,041.00
8293*	Single Dummy Trim	\$329.00	\$341.00
8294	Double Dummy Trim	\$652.00	\$676.00
8295	Single Dummy Trim w/Lockbody	\$432.00	\$444.00
8296	Double Dummy Trim w/Lockbody	\$757.00	\$781.00
8297	Double Dummy w/Active Trim	\$847.00	\$871.00

* "A" Lever Only – Specify hand and if for inside or outside of door, when ordering.

Experience a safer
and more open world

ML-26 MORTISE LOCKS

SARGENT®

ASSA ABLOY

OPTIONS

USA & Canada Prices Effective May 1, 2021

Options	Description	Price
1▲	8200 Line with 1-1/16" wide front for 1-3/8" doors.	\$62.00
3	Stainless steel hub (not available with 8289, 8291 & 8292 functions)	\$69.00
10▲	SARGENT Signature Key System	\$63.00 / cyl.
11†▲	SARGENT XC Key System (not available w/10, KESO, SC, SE)	No addition
1160	SARGENT XC Large Format Interchangeable Plastic Disposable Construction Core	No addition
1163	SARGENT XC Large Format Interchangeable Core Cylinder - Includes masterkeying charges	\$83.00
1164	SARGENT XC Large Format Interchangeable Construction Core Cylinder	\$83.00
1170	Small Format interchangeable disposable construction core - to accept 7 Pin XC permanent core	No addition
11727P	Small Format interchangeable keyed construction core - to accept 7 Pin XC permanent core	\$75.00
11737P	Small Format interchangeable core - to accept 7 pin XC permanent core	\$75.00 /cyl.
21▲†	SARGENT Construction Key System (lost ball) Standard on all new systems established since 5/1/96	\$16.00 / cyl.
22▲†	SARGENT Construction Key System (split key) To be used on pre-established split key systems only	\$32.00 / cyl.
23	Locksets with flat 4 7/8" ANSI strike	No addition
31	Thick Doors - Extended Lip Required - Specify Length C to E IMPORTANT: See 7800/8200 Catalog Option Page for Cylinder Limits – DOES NOT include additional Charges for Special Cylinder Requirements	No addition
	Doors up to 2-1/2" thick - lock centered • Doors 2-5/8" to 6" thick OR doors 1-3/4" thick w/max 1" paneling one side. For example: Specify 1-3/4" door with panel (Side) on inside or outside	Non Keyed function \$50.00 Keyed function \$100.00
36	6 Lobe security head screws	\$24.00
37	Spanner head screws	\$17.00
60	SARGENT Large Format Interchangeable Plastic Disposable Construction Core	No addition
63	SARGENT Large Format Interchangeable core cylinder, includes master keying charges	\$83.00 / cyl
64	SARGENT Large Format Interchangeable Construction Core Cylinder	\$83.00
6573▲†	Small Format 6-Pin Uncombined Core (Refer to CK-12)	\$65.00 / cyl.
65737P▲†	Small Format 7-Pin Uncombined Core (Refer to CK-12)	\$65.00 / cyl.
68	8200 Line furnished with lever handle outside x knob inside (Excludes SLD Detention Knob)	Defaults to 8200 Lever Lock Price
69	8200 Line furnished with lever handle inside x knob outside (Excludes SLD Detention Knob)	Defaults to 8200 Lever Lock Price
70▲†	Small Format interchangeable disposable plastic construction core	No addition
72▲†	Small Format interchangeable 6-Pin construction core	\$75.00
73▲†	Small Format interchangeable core 6-pin Includes MK and GMK keying charges	\$75.00 / cyl
737P▲†	Small Format interchangeable core 7-pin (refer to CK-12 for available keyways) Includes MK and GMK keying charges	\$75.00 / cyl
75	Tactile Warning - Milled Inside Lever	\$78.00
76	Tactile Warning - Milled Outside Lever	\$78.00
77	Tactile Warning - Milled Outside and Inside Lever	\$156.00
81▲†	Cylinder to accept Keso (83) and Keso F1 (F183) removable core – no core provided	No addition
F182†	SARGENT Keso Security Cylinder – patented – new key systems	\$91.00 / cyl.
F183▲†	SARGENT Keso Security Removable Core Cylinder – patented – new key systems	\$130.00 / cyl.
82†	SARGENT Keso Security Cylinder (For existing systems only)	\$91.00 / cyl.
83▲†	SARGENT Keso Security Removable Core Cylinder (For existing systems only)	\$130.00 / cyl.
84▲†	SARGENT Keso Security Removable Construction Core Cylinder	See CK-18
85	Tactile Warning - Abrasive Coating on Inside Lever	\$49.00
86	Tactile Warning - Abrasive Coating on Outside Lever	\$49.00
87	Tactile Warning - Abrasive Coating on Outside & Inside Lever	\$98.00
AV	Anti Vandal Pull Trim (available in 32D finish), (Not available with 8270, 8271, 8272, 8273 functions)	\$229.00
BR	SARGENT Bump Resistant Cylinders (N/A w/10, 22, 30, 60, 63, 64, 70, 72, 73, 737P, KESO, SC, & SE options)	\$25.00 /cyl.
DG1	Patented Degree DG1 Key System	No addition
DG160	Hardware prepared for DG1-6300 Lg. Format IC cores, supplied with temporary plastic construction cores	No addition
DG163	Patented Degree DG1 Large Format Interchangeable Core Cylinder - Includes master keying charges	\$83.00
DG164	Hardware prepared for DG1-6300 Lg. Format IC cores, supplied with temporary keyed construction cores	\$83.00
DG2	Patented Degree DG2 Key System incorporating a locking sidebar	\$63.00/cyl.
DG260	Hardware prepared for DG2-6300 Lg. Format IC cores, supplied with temporary plastic construction cores	No addition
DG263	Patented Degree DG2 Large Format Interchangeable Core Cylinder - Includes master keying charges	\$146.00
DG264	Hardware prepared for DG2-6300 Lg. Format IC cores, supplied with temporary keyed construction cores	\$83.00
DG3	Patented Degree DG3 Key System incorporating a locking sidebar and UL437 listed	\$89.00/cyl.
DG360	Hardware prepared for DG3-6300 Lg. Format IC cores, supplied with temporary plastic construction cores	No addition
DG363	Patented Degree DG3 Large Format Interchangeable Core Cylinder - Includes master keying charges	\$172.00
DG364	Hardware prepared for DG3-6300 Lg. Format IC cores, supplied with temporary keyed construction cores	\$83.00
IDP	Integrated Door Position Switch	\$108.00
LB	Extra large thumbturn	\$18.00
LC	Less Cylinder	-\$96.00/cyl.
OBS	Open Back Strike	\$79.00
PHR	Deadbolt Privacy Function (available w/deadbolt function only)	\$100.00
R01	Mercury and Lenel compatible 1KΩ/2KΩ resistance supervision	\$100.00
R03	Software House compatible 1KΩ/2KΩ resistance supervision	\$100.00
R04	AMAG compatible 4-state supervision	\$100.00
SC▲†	Schlage "C" Keyway cylinder, (Number 41 Cylinder Only, 0 bitted)	No addition
SE▲†	Schlage "E" Keyway cylinder, (Number 41 Cylinder Only, 0 bitted)	No addition
SG	MicroShield® – an antimicrobial powder coat finish	\$73.00
WBS	Wrought Box Strike	No addition
NOTES:	▲ Options not avail. with a standard 50 function lockout cylinder. † Not avail. with 60, 63, 64 options	
CPC	Clear Powder Coat over 26D/32D – NAC-82280-24V x WTA x RH x 32D x CPC All orders will continue to be handled as a "special" when CPC is ordered.	\$67.00

Experience a safer
and more open world

Copyright © 2002-2021 Sargent Manufacturing Company, an ASSA ABLOY Group company. All rights reserved.
Reproduction in whole or in part without the express written permission of Sargent Manufacturing Company is prohibited.
Contact us at: 800-727-5477 or visit www.sargentlock.com. In Canada contact us at: 800-461-3007 or visit www.assaabloydss.ca

USA & Canada
Prices Effective
May 1, 2021

WT Escutcheon
• A-B-E-F-J-L-P-W Levers



WTA



WTL



WTJ

NAC 8200 Electrified Mortise Locks with High Security Monitoring				10BE/26D/ BSP/WSP	03/04/09/10/ 10B/10BL/14/15/ 20D/26/32/32D
Option	Function	Trim - Proximity Entry	Description		
NAC	82270-12V/-24V	Rose x Lever Design	Fail Safe w/Cylinder Override	\$1,400.00	\$1,424.00
NAC	82271-12V/-24V	Rose x Lever Design	Fail Secure w/Cylinder Override		
NAC	82280-12V/-24V	Rose x Lever Design	Fail Safe w/Deadbolt w/Cyl.Override	\$1,475.00	\$1,499.00
NAC	82281-12V/-24V	Rose x Lever Design	Fail Secure w/D.bolt w/Cyl.Override		
NAC	82274-12V/-24V	Rose x Lever Design	Fail Safe - No Cylinder	\$1,345.00	\$1,369.00
NAC	82275-12V/-24V	Rose x Lever Design	Fail Secure - No Cylinder		
NAC	82284-12V/-24V	Rose x Lever Design	Fail Safe w/Deadbolt - No Cylinder	\$1,420.00	\$1,444.00
NAC	82285-12V/-24V	Rose x Lever Design	Fail Secure w/Deadbolt - No Cylinder		

Note: Consult catalog for ordering information.
Specify hand and voltage (12v or 24v) when ordering

ML-28 MORTISE LOCKS

SARGENT®

ASSA ABLOY

OPTIONS

USA & Canada Prices Effective May 1, 2021

Options	Description	Price
3	Stainless steel hub (not available with 8289, 8291 & 8292 functions)	\$69.00
10▲	SARGENT Signature Key System	\$63.00 / cyl.
11▲	SARGENT XC Key System (not available with 10, 22, SC, SE options)	No addition
21▲	SARGENT Construction Key System (lost ball) Standard on all new systems established since 5/1/96	\$16.00 / cyl.
22▲	SARGENT Construction Key System (split key) To be used on pre-established split key systems only	\$32.00 / cyl.
23	Locksets with flat 4-7/8" ANSI strike	No addition
31	Thick Doors - Extended Lip Required - Specify Length C to E - Cylinders - IMPORTANT- See catalog 7800/8200 option page for cylinder limitations - Below charges DO NOT include additional charges for special cylinder requirements	
	Doors up to 2-1/2" thick - lock centered	No addition
	Doors 2-5/8" to 6" thick OR doors 1-3/4" thick w/max 1" paneling one side. For example: Specify 1-3/4" door with panel (Side) on inside or outside	Non Keyed function \$50.00 Keyed function \$100.00
36	6 Lobe security head screws	\$24.00
68	8200 Line furnished with lever handle outside x knob inside (Excludes SLD Detention Knob)	Defaults to 8200 Lever Lock Price
69	8200 Line furnished with lever handle inside x knob outside (Excludes SLD Detention Knob)	Defaults to 8200 Lever Lock Price
75	Tactile Warning - Milled Inside Lever (Not available with A lever)	\$78.00
76	Tactile Warning - Milled Outside Lever (Not available with A lever)	\$78.00
77	Tactile Warning - Milled Outside and Inside Lever (Not available with A lever)	\$156.00
F182	SARGENT Keso Security Cylinder – patented – new key systems	\$91.00 cyl.
82	SARGENT KESO Security Cylinder (For existing systems only)	\$91.00 cyl.
85	Tactile Warning - Abrasive Coating on Inside Lever	\$49.00
86	Tactile Warning - Abrasive Coating on Outside Lever	\$49.00
87	Tactile Warning - Abrasive Coating on Outside & Inside Lever	\$98.00
BR	SARGENT Bump Resistant Cylinders (N/A w/10, 22, 30, 60, 63, 64, 70, 72, 73, 737P, KESO, SC, & SE options)	\$25.00 /cyl.
DX	Deadbolt Monitoring (not available with 74)	\$197.00
LB	Extra large thumbturn	\$18.00
LC	Less Cylinder	-\$96.00/cyl.
LX	Latchbolt Monitor – available with all non-deadbolt functions; not available with DX option	\$200.00
OBS	Open Back Strike	\$79.00
SC▲	Schlage "C" Keyway cylinder, (Number 41 Cylinder Only, 0 bitted)	No addition
SE▲	Schlage "E" Keyway cylinder, (Number 41 Cylinder Only, 0 bitted)	No addition
SG	MicroShield® – an antimicrobial powder coat finish	\$73.00
WBS	Wrought Box Strike	No addition

NOTES: ▲ Options not available with a standard 50 function lockout cylinder.

CPC	Clear Powder Coat over 26D/32D – 8205 x LSL x RH x 32D x CPC All orders will continue to be handled as a "special" when CPC is ordered.	\$67.00
-----	--	---------



LS

LS Escutcheon • A-B-E-F-J-L-P-W Levers

USA & Canada Prices Effective May 1, 2021

Function		Finish	
		10BE/26D/BSP/WSP	03/04/09/10/10B/10BL/14/15/20D/26/32/32D
Single Cyl			
8204	Storeroom or Closet		
8205	Office or Entry	\$1,732.00	\$1,756.00
8237	Classroom		
8255	Office or Entry		
<hr/>			
8206	Storeroom or Service		
8231	Utility		
8236	Closet		
8256	Office or Inner Entry	\$1,760.00	\$1,784.00
8257, 8258, 8267	Institutional Privacy		
8289	Holdback		
8291	All Purpose Holdback		
<hr/>			
Single Cyl With Deadbolt			
8224	Room Door		
8225	Dormitory or Exit		
8235	Storeroom		
8227	Closet or Storeroom	\$1,784.00	\$1,808.00
8228, 8230	Dummy Trim Deadlock		
8243	Apartment Corridor		
8245	Dormitory or Exit		
8247	Front Door or Apartment Corridor		
8251	Storeroom Deadbot		
8250	Hotel Guest Lock	\$1,830.00	\$1,854.00
<hr/>			
Double Cyl No Deadbolt			
8216	Apartment or Exit or Public Toilet		
8217	Asylum or Institutional		
8238	Classroom Security Intruder		
8242	Classroom Security Intruder Latchbolt	\$1,845.00	\$1,869.00
8259	School Security		
8290	Classroom Security Holdback		
8292	All Purpose Holdback		
<hr/>			
Double Cyl With Deadbolt			
8226	Store Door		
8229	Dummy Trim Deadlock		
8239, 8240	Classroom Security Intruder		
8241	Classroom Security	\$1,863.00	\$1,887.00
8246	Dormitory or Exit		
8248	Store Door		
8249	Security Deadbot		
8252	Institutional		
<hr/>			
Non Keyed			
8213	Communication or Exit	\$1,530.00	\$1,554.00
8215	Passage or Closet		
8265	Privacy Bedroom or Bath (Latch)	\$1,648.00	\$1,672.00
8266, 8268	Privacy Bedroom or Bath (Deadbolt)	\$1,720.00	\$1,744.00
8293	Single Dummy Trim	\$570.00	\$582.00
8294	Double Dummy Trim	\$1,143.00	\$1,167.00
8295	Single Dummy Trim w/Lockbody	\$730.00	\$742.00
8296	Double Dummy Trim w/Lockbody	\$1,303.00	\$1,327.00
8297	Double Dummy w/Active Trim	\$1,436.00	\$1,460.00

NOTE

Available with size #41 cylinder only. Cylinder lip sits behind escutcheon.

Consult factory for 70, 71, 72, and 73 functions.

Locks supplied standard with 4 spanner head screws on escutcheon only.

Experience a safer
and more open world

ML-30 8200 FREEWHEELING

SARGENT®

ASSA ABLOY

OPTIONS

USA & Canada Prices Effective May 1, 2021

Options	Description	Price
1-	8200 Line with 1-1/16" wide front for 1-3/8" door	\$62.00
3	Stainless steel hub (not available with 8289, 8291 & 8292 functions)	\$69.00
10	Signature Key System	\$63.00 /cyl.
11†	SARGENT XC Key System (not available with 10, 22, SC, SE options)	No addition
1160	SARGENT XC Large Format Interchangeable Plastic Disposable Construction Core	No addition
1163	SARGENT XC Large Format Interchangeable Core Cylinder - Includes masterkeying charges	\$83.00
1164	SARGENT XC Large Format Interchangeable Construction Core Cylinder	\$83.00
1170	Small Format interchangeable disposable construction core - to accept 7 Pin XC permanent core	No addition
11727P	Small Format interchangeable keyed construction core - to accept 7 Pin XC permanent core	75
11737P	Small Format interchangeable core - to accept 7 pin XC permanent core	\$75.00
21†	SARGENT Construction Keying System (Lost Ball) standard on all new systems est. since 5/1/96	\$16.00 /cyl.
22†	SARGENT Construction Keying System (Split Key) to be used on pre-established split keys only	\$32.00 /cyl.
23	Locksets with flat 4-7/8" ANSI strike	No addition
31◆	Doors over 1-3/4" thick	Consult Factory
36	6 Lobe security screws	\$24.00
37	Spanner head security screws	\$17.00
60	SARGENT Large Format Interchangeable Plastic Disposable Construction Core	No addition
63	SARGENT Large Format Interchangeable core cylinder, includes master keying charges	\$83.00 /cyl.
64	SARGENT Large Format Interchangeable Construction Core Cylinder	\$83.00
70	Small Format interchangeable disposable plastic construction core (Not available with J lever)	No addition
72	Small Format interchangeable 6-Pin construction core (not available with J lever)	\$75.00
73	Small Format interchangeable core 6-pin Includes MK and GMK keying charges (Not available with J lever)	\$75.00
737P	Small Format interchangeable core 7-pin (refer to CK-12 for available keyways) - Includes MK and GMK keying charges (Not available with J lever)	\$75.00
75	Tactile Warning - Milled Inside Lever (Not available with A lever)	\$78.00
76	Tactile Warning - Milled Outside Lever (Not available with A lever)	\$78.00
77	Tactile Warning - Milled Outside and Inside Lever (Not available with A lever)	\$156.00
F182†	SARGENT Keso Security Cylinder – patented – new key systems	\$91.00 /cyl.
82†	SARGENT KESO Security Cylinder (For existing systems only)	\$91.00 /cyl.
85	Tactile Warning - Abrasive coating on inside lever	\$49.00
86	Tactile Warning - Abrasive coating on outside lever	\$49.00
87	Tactile Warning - Abrasive coating on both levers	\$98.00
BR	SARGENT Bump Resistant Cylinders (N/A w/10, 22, 30, 60, 63, 64, 70, 72, 73, 737P, KESO, SC, & SE options)	\$25.00 /cyl.
DG1	Patented Degree DG1 Key System	No addition
DG160	Hardware prepared for DG1-6300 Lg. Format IC cores, supplied with temporary plastic construction cores	No addition
DG163	Patented Degree DG1 Large Format Interchangeable Core Cylinder - Includes master keying charges	\$83.00
DG164	Hardware prepared for DG1-6300 Lg. Format IC cores, supplied with temporary keyed construction cores	\$83.00
DG2	Patented Degree DG2 Key System incorporating a locking sidebar	\$63.00/cyl.
DG260	Hardware prepared for DG2-6300 Lg. Format IC cores, supplied with temporary plastic construction cores	No addition
DG263	Patented Degree DG2 Large Format Interchangeable Core Cylinder - Includes master keying charges	\$146.00
DG264	Hardware prepared for DG2-6300 Lg. Format IC cores, supplied with temporary keyed construction cores	\$83.00
DG3	Patented Degree DG3 Key System incorporating a locking sidebar and UL437 listed	\$89.00/cyl.
DG360	Hardware prepared for DG3-6300 Lg. Format IC cores, supplied with temporary plastic construction cores	No addition
DG363	Patented Degree DG3 Large Format Interchangeable Core Cylinder - Includes master keying charges	\$172.00
DG364	Hardware prepared for DG3-6300 Lg. Format IC cores, supplied with temporary keyed construction cores	\$83.00
LB	Extra large thumbturn	\$18.00
LC	Less Cylinder	-\$96.00/cyl.
OBS	Open Back Strike	\$79.00
SG	MicroShield® – an antimicrobial powder coat finish	\$73.00
WBS	Wrought Box Strike	No addition

NOTES: † Not available with 60, 63, 64 options. ◆ Consult factory for availability of cylinders for thick doors.

CPC	Clear Powder Coat over 26D/32D – 8205 x FEL x RH x 32D x CPC All orders will continue to be handled as a "special" when CPC is ordered.	\$67.00
-----	--	---------

Experience a safer
and more open world

Copyright © 2002-2021 Sargent Manufacturing Company, an ASSA ABLOY Group company. All rights reserved.
Reproduction in whole or in part without the express written permission of Sargent Manufacturing Company is prohibited.
Contact us at: 800-727-5477 or visit www.sargentlock.com. In Canada contact us at: 800-461-3007 or visit www.assaabloydss.ca



Trim is handed — Please specify hand when ordering.

FE Escutcheon • A-B-E-F-J-L-P-W Levers

Function		Finish	
		10BE/26D/BSP/WSP	03/04/09/10/10B/10BL/14/15/20D/26
Single Cyl			
8204	Storeroom or Closet		
8205	Office or Entry	\$1,246.00	\$1,270.00
8237	Classroom		
8231	Utility		
8236	Closet	\$1,272.00	\$1,296.00
Single Cyl With Deadbolt			
8224	Room Door		
8225	Dormitory or Exit	\$1,300.00	\$1,324.00
8235	Storeroom		
8251	Storeroom Deadbolt		
Double Cyl With Deadbolt			
8216	Apartment or Exit or Public Toilet		
8217	Asylum or Institutional	\$1,351.00	\$1,375.00
8238	Classroom Security Intruder		
8242	Classroom Security Intruder Latchbolt		
Double Cyl With Deadbolt		\$1,374.00	\$1,398.00
8226	Store Door		
8239, 8240	Classroom Security Intruder		
Non Keyed		\$1,167.00	\$1,191.00
8265	Privacy Bedroom or Bath (Latch)	\$1,200.00	\$1,224.00
8266	Privacy Bedroom or Bath (Deadbolt)		

ML-32 MORTISE LOCKS

For V Series
Indicators
Click / See
Page ML-1A

SARGENT®

ASSA ABLOY

OPTIONS

USA & Canada Prices Effective May 1, 2021

Options	Description	Price
1▲	8200 Line with 1-1/16" wide front for 1-3/8" doors.	\$62.00
3	Stainless steel hub (not available with 8289, 8291 & 8292 functions)	\$69.00
10▲	SARGENT Signature Key System	\$63.00/ cyl.
11†▲	SARGENT XC Key System (not available with 10, 22, SC, SE options)	No addition
1160	SARGENT XC Large Format Interchangeable Plastic Disposable Construction Core	No addition
1163	SARGENT XC Large Format Interchangeable Core Cylinder - Includes masterkeying charges	\$83.00
1164	SARGENT XC Large Format Interchangeable Construction Core Cylinder	\$83.00
1170	Small Format interchangeable disposable construction core - to accept 7 Pin XC permanent core	No addition
11727P	Small Format interchangeable keyed construction core - to accept 7 Pin XC permanent core	\$75.00
11737P	Small Format interchangeable core - to accept 7 pin XC permanent core	\$75.00/cyl.
21▲†	SARGENT Construction Key System (lost ball) Standard on all new systems established since 5/1/96	\$16.00/ cyl.
22▲†	SARGENT Construction Key System (split key) To be used on pre-established split key systems only	\$32.00/ cyl.
31	Thick Doors - Extended Lip Required - Specify Length C to E - Cylinders - IMPORTANT- See catalog 7800/8200 option page for cylinder limitations - Below charges DO NOT include additional charges for special cylinder requirements	
	Doors up to 2-1/2" thick - lock centered	No addition
	Doors 2-5/8" to 6" thick OR doors 1-3/4" thick w/max 1" paneling one side. For example: Specify 1-3/4" door with panel (Side) on inside or outside	Non Keyed function \$50.00 Keyed function \$100.00
36	6 Lobe security head screws	\$24.00
37	Spanner head screws	\$17.00
49	Visual Status Indicator - Available with 30, 36, 37 function - Rose Trims CR, E, L, LN, O, TR - Available with 26, 29, 38, 39 40, 41 functions - Rose Trim 8200 LN	\$140.00
49	Occupancy Indicator with emergency Release - Available with 65, 66, 68 functions; Rose Trims 7800 CR, E, L, LN, O, TR	\$140.00
50	Secured Indicator Rose- doors 1-5/8" to 2-1/4" thick- Avail.w/ 24,25,26,28,29,30,36,37,38,39,40,41,43,45,50,51,52,67 functs.	\$140.00
60	SARGENT Large Format Interchangeable Plastic Disposable Construction Core	No addition
63	SARGENT Large Format Interchangeable core cylinder, includes master keying charges	\$83.00/ cyl.
64	SARGENT Large Format Interchangeable Construction Core Cylinder	\$83.00
6573▲†	Small Format 6-Pin Uncombined Core (Refer to CK-12)	\$65.00/ cyl.
65737P▲†	Small Format 7-Pin Uncombined Core (Refer to CK-12)	\$65.00/ cyl.
68	8200 Line furnished with lever handle outside x knob inside (Excludes SLD Detention Knob)	Defaults to 8200 Lever Lock Price
69	8200 Line furnished with lever handle inside x knob outside (Excludes SLD Detention Knob)	Defaults to 8200 Lever Lock Price
70▲†	Small Format Interchangeable disposable plastic construction core	No addition
72▲†	Small Format interchangeable core 6-pin Includes MK and GMK keying charges	\$75.00
73▲†	Small Format interchangeable core 6-pin Includes MK and GMK keying charges	\$75.00/ cyl
737P▲†	Small Format interchangeable core 7-pin (refer to CK-12 for available keyways) Includes MK and GMK keying charges	\$75.00 cyl
74	Lock case wrapped in lead - handling required (roses not available)	\$294.00
81▲†	Cylinder to accept Keso (83) and Keso F1 (F183) removable core - no core provided	No addition
F182†	SARGENT Keso Security Cylinder - patented - new key systems	\$91.00/ cyl.
F183▲†	SARGENT Keso Security Removable Core Cylinder - patented - new key systems	\$130.00/ cyl.
82†	SARGENT Keso Security Cylinder (For existing systems only)	\$91.00/ cyl.
83▲†	SARGENT Keso Security Removable Core Cylinder (For existing systems only)	\$130.00/ cyl.
84▲†	SARGENT Keso Security Removable Construction Core Cylinder	See CK-18
85	Tactile Warning - Abrasive coating on inside lever	\$49.00
86	Tactile Warning - Abrasive coating on outside lever	\$49.00
87	Tactile Warning - Abrasive coating on both levers	\$98.00
AV	Anti Vandal Pull Trim (available in 32D finish), (Not available with 8270, 8271, 8272, 8273 functions)	\$229.00
BR	SARGENT Bump Resistant Cylinders (N/A w/10, 22, 30, 60, 63, 64, 70, 72, 73, 737P, KESO, SC, SE)	\$25.00/cyl.
DX	Deadbolt Monitoring (not available with 50, 74)	\$197.00
DG1	Patented Degree DG1 Key System	No addition
DG160	Hardware prepared for DG1-6300 Lg. Format IC cores, supplied with temporary plastic construction cores	No addition
DG163	Patented Degree DG1 Large Format Interchangeable Core Cylinder - Includes master keying charges	\$83.00
DG164	Hardware prepared for DG1-6300 Lg. Format IC cores, supplied with temporary keyed construction cores	\$83.00
DG2	Patented Degree DG2 Key System incorporating a locking sidebar	\$63.00/cyl.
DG260	Hardware prepared for DG2-6300 Lg. Format IC cores, supplied with temporary plastic construction cores	No addition
DG263	Patented Degree DG2 Large Format Interchangeable Core Cylinder - Includes master keying charges	\$146.00
DG264	Hardware prepared for DG2-6300 Lg. Format IC cores, supplied with temporary keyed construction cores	\$83.00
DG3	Patented Degree DG3 Key System incorporating a locking sidebar and UL437 listed	\$89.00/cyl.
DG360	Hardware prepared for DG3-6300 Lg. Format IC cores, supplied with temporary plastic construction cores	No addition
DG363	Patented Degree DG3 Large Format Interchangeable Core Cylinder - Includes master keying charges	\$172.00
DG364	Hardware prepared for DG3-6300 Lg. Format IC cores, supplied with temporary keyed construction cores	\$83.00
LB	Extra large thumbturn	\$18.00
LC	Less Cylinder	-\$96.00/cyl.
LX	Latchbolt Monitor - available with all non-deadbolt functions; not available with DX option	\$200.00
OBS	Open Back Strike	\$79.00
RX	Request to Exit	\$206.00
SC▲†	Schlage "C" Keyway cylinder, (Number 41 Cylinder Only, 0 bitted)	No addition
SE▲†	Schlage "E" Keyway cylinder, (Number 41 Cylinder Only, 0 bitted)	No addition
SG	MicroShield® - an antimicrobial powder coat finish	\$73.00
T1	Decorative thumbturn; backplate matches rose design chosen	No Addition
T2	Decorative square thumbturn; backplate matches rose design chosen	No Addition
T3	Decorative cylinder thumbturn; backplate matches rose design chosen	No Addition
WBS	Wrought Box Strike	No addition

NOTES: ▲ Options not avail. with a standard 50 function lockout cylinder. † Not avail. with 60, 63, 64 options

CPC Clear Powder Coat over 26D/32D - 8205 x TRY x RH x 32D x CPC \$67.00
All orders will continue to be handled as a "special" when CPC is ordered.

Experience a safer
and more open world

Copyright © 2002-2021 Sargent Manufacturing Company, an ASSA ABLOY Group company. All rights reserved.
Reproduction in whole or in part without the express written permission of Sargent Manufacturing Company is prohibited.
Contact us at: 800-727-5477 or visit www.sargentlock.com. In Canada contact us at: 800-461-3007 or visit www.assaabloydss.ca

ASSA ABLOY

COASTAL SERIES DESIGN - 8200



USA & Canada Prices Effective May 1, 2021

TR Rose - 2" Dia • CR Rose - 2-3/16" Dia • G-R-S-Y Levers

Note: hands required when ordering G-S-Y Levers

TRY shown.

Function		Finish	
		10BE/26D/BSP/WSP	03/04/09/10/10B/10BL/14/15/20D/26
Single Cyl			
8204	Storeroom or Closet		
8205	Office or Entry		
8237	Classroom	\$1,094.00	\$1,118.00
8255	Office or Entry		
8206	Storeroom or Service		
8231	Utility		
8236	Closet		
8256	Office or Inner Entry	\$1,121.00	\$1,145.00
8257, 8258, 8267	Institutional Privacy		
8289	Holdback		
8291	All Purpose Holdback		
Single Cyl With Deadbolt			
8224	Room Door		
8225	Dormitory or Exit		
8227	Closet or Storeroom		
8228, 8230	Dummy Trim Deadlock		
8235	Storeroom	\$1,153.00	\$1,177.00
8243	Apartment Corridor		
8245	Dormitory or Exit		
8247	Front Door or Apartment Corridor		
8251	Storeroom Deadbolt		
8250	Hotel Guest Lock	\$1,188.00	\$1,212.00
Double Cyl No Deadbolt			
8216	Apartment or Exit or Public Toilet		
8217	Asylum or Institutional		
8238	Classroom Security Intruder	\$1,205.00	\$1,229.00
8242	Classroom Security Intruder Latchbolt		
8259	School Security		
8290	Classroom Security Holdback		
8292	All Purpose Holdback		
Double Cyl With Deadbolt			
8226	Store Door		
8229	Dummy Trim Deadlock		
8239, 8240	Classroom Security Intruder	\$1,228.00	\$1,252.00
8241	Classroom Security		
8246	Dormitory or Exit		
8248	Store Door		
8249	Security Deadbolt		
8252	Institutional		
Electro Mechanical Single Cyl – Specify 12V or 24V		\$1,290.00	\$1,314.00
8270-12V / 8270-24V	Fail Safe		
8271-12V / 8271-24V	Fail Secure		
Electro Mechanical Double Cyl – Specify 12V or 24V		\$1,347.00	\$1,371.00
8272-12V / 8272-24V	Fail Safe		
8273-12V / 8273-24V	Fail Secure		
Non Keyed			
8213	Communication or Exit	\$877.00	\$901.00
8215	Passage or Closet	\$965.00	\$989.00
8265	Privacy Bedroom or Bath (Latch)	\$1,069.00	\$1,093.00
8266, 8268	Privacy Bedroom or Bath (Deadbolt)	\$362.00	\$374.00
8293	Single Dummy Trim	\$723.00	\$747.00
8294	Double Dummy Trim	\$464.00	\$476.00
8295	Single Dummy Trim w/Lockbody	\$830.00	\$854.00
8296	Double Dummy Trim w/Lockbody	\$920.00	\$944.00
8297	Double Dummy Trim w/Active Trim		

Experience a safer
and more open world

ML-34 MORTISE LOCKS

For V Series
Indicators
Click / See
Page ML-1A

SARGENT®

ASSA ABLOY

OPTIONS

USA & Canada Prices Effective May 1, 2021

Options	Description	Price
1▲	8200 Line with 1-1/16" wide front for 1-3/8" doors.	\$62.00
3	Stainless steel hub (not available with 8289, 8291 & 8292 functions)	\$69.00
10▲	SARGENT Signature Key System	\$63.00/ cyl.
11†▲	SARGENT XC Key System (not available w/10, KESO, SC, SE)	No addition
1160	SARGENT XC Large Format Interchangeable Plastic Disposable Construction Core	No addition
1163	SARGENT XC Large Format Interchangeable Core Cylinder - Includes masterkeying charges	\$83.00
1164	SARGENT XC Large Format Interchangeable Construction Core Cylinder	\$83.00
1170	Small Format interchangeable disposable construction core - to accept 7 Pin XC permanent core	No addition
11727P	Small Format interchangeable keyed construction core - to accept 7 Pin XC permanent core	\$75.00
11737P	Small Format interchangeable core - to accept 7 pin XC permanent core	\$75.00/cyl.
21▲†	SARGENT Construction Key System (lost ball) Standard on all new systems established since 5/1/96	\$16.00/ cyl.
22▲†	SARGENT Construction Key System (split key) To be used on pre-established split key systems only	\$32.00/ cyl.
23	Locksets with flat 4 7/8" ANSI strike	No addition
31	Thick Doors - Extended Lip Required - Specify Length C to E IMPORTANT: See 7800/8200 Catalog Option Page for Cylinder Limits - DOES NOT include additional Charges for Special Cylinder Requirements	No addition
	Doors up to 2-1/2" thick - lock centered • Doors 2-5/8" to 6" thick OR doors 1-3/4" thick w/max 1" paneling one side. For example: Specify 1-3/4" door with panel (Side) on inside or outside	Non Keyed function \$50.00 Keyed function \$100.00
36	6 Lobe security head screws	\$24.00
37	Spanner head screws	\$17.00
49	Visual Status Indicator - Available with 30, 36, 37 function - Rose Trims CR, E, L, LN, O, TR - Available with 26, 29, 38, 39 40, 41 functions - Rose Trim 8200 LN	\$140.00
49	Occupancy Indicator with emergency Release - Available with 65, 66, 68 functions; Rose Trims 7800 CR, E, L, LN, O, TR	\$140.00
50	Secured Indicator Rose- doors 1-5/8" to 2-1/4" thick- Avail.w/24,25,26,28,29,30,36,37,38,39,40,41,43,45,50,51,52,57,58,67 functions	\$140.00
60	SARGENT Large Format Interchangeable Plastic Disposable Construction Core	No addition
63	SARGENT Large Format Interchangeable core cylinder, includes master keying charges	\$83.00/ cyl
64	SARGENT Large Format Interchangeable Construction Core Cylinder	\$83.00
6573▲†	Small Format 6-Pin Uncombined Core (Refer to CK-12)	\$65.00/ cyl.
65737P▲†	Small Format 7-Pin Uncombined Core (Refer to CK-12)	\$65.00/ cyl.
70▲†	Small Format interchangeable disposable plastic construction core	No addition
72▲†	Small Format interchangeable 6-Pin construction core	\$75.00
73▲†	Small Format interchangeable core 6-pin Includes MK and GMK keying charges	\$75.00/ cyl
737P▲†	Small Format interchangeable core 7-pin (refer to CK-12 for available keyways) Includes MK and GMK keying charges	\$75.00/ cyl
81▲†	Cylinder to accept Keso (83) and Keso F1 (F183) removable core - no core provided	No addition
F182†	SARGENT Keso Security Cylinder - patented - new key systems	\$91.00/ cyl.
F183▲†	SARGENT Keso Security Removable Core Cylinder - patented - new key systems	\$130.00/ cyl.
82†	SARGENT Keso Security Cylinder (For existing systems only)	\$91.00/ cyl.
83▲†	SARGENT Keso Security Removable Core Cylinder (For existing systems only)	\$130.00/ cyl.
84▲†	SARGENT Keso Security Removable Construction Core Cylinder	See CK-18
85	Tactile Warning - Abrasive Coating on Inside Lever	\$49.00
86	Tactile Warning - Abrasive Coating on Outside Lever	\$49.00
87	Tactile Warning - Abrasive Coating on Outside & Inside Lever	\$98.00
AV	Anti Vandal Pull Trim (available in 32D finish) (Not available with 8270, 8271, 8272, 8273 functions)	\$229.00
BR	SARGENT Bump Resistant Cylinders (N/A w/10, 22, 30, 60, 63, 64, 70, 72, 73, 737P, KESO, SC, & SE options)	\$25.00/cyl.
DG1	Patented Degree DG1 Key System	No addition
DG160	Hardware prepared for DG1-6300 Lg. Format IC cores, supplied with temporary plastic construction cores	No addition
DG163	Patented Degree DG1 Large Format Interchangeable Core Cylinder - Includes master keying charges	\$83.00
DG164	Hardware prepared for DG1-6300 Lg. Format IC cores, supplied with temporary keyed construction cores	\$83.00
DG2	Patented Degree DG2 Key System incorporating a locking sidebar	\$63.00/cyl.
DG260	Hardware prepared for DG2-6300 Lg. Format IC cores, supplied with temporary plastic construction cores	No addition
DG263	Patented Degree DG2 Large Format Interchangeable Core Cylinder - Includes master keying charges	\$146.00
DG264	Hardware prepared for DG2-6300 Lg. Format IC cores, supplied with temporary keyed construction cores	\$83.00
DG3	Patented Degree DG3 Key System incorporating a locking sidebar and UL437 listed	\$89.00/cyl.
DG360	Hardware prepared for DG3-6300 Lg. Format IC cores, supplied with temporary plastic construction cores	No addition
DG363	Patented Degree DG3 Large Format Interchangeable Core Cylinder - Includes master keying charges	\$172.00
DG364	Hardware prepared for DG3-6300 Lg. Format IC cores, supplied with temporary keyed construction cores	\$83.00
IDP	Integrated Door Position Switch	\$108.00
LB	Extra large thumbturn	\$18.00
LC	Less Cylinder	-\$96.00/cyl.
OBS	Open Back Strike	\$79.00
PHR	Deadbolt Privacy Function (available w/deadbolt function only)	\$100.00
R01	Mercury and Lenel compatible 1KΩ/2KΩ resistance supervision	\$100.00
R03	Software House compatible 1KΩ/2KΩ resistance supervision	\$100.00
R04	AMAG compatible 4-state supervision	\$100.00
SC▲†	Schlage "C" Keyway cylinder, (Number 41 Cylinder Only, 0 bitted)	No addition
SE▲†	Schlage "E" Keyway cylinder, (Number 41 Cylinder Only, 0 bitted)	No addition
SG	MicroShield® - an antimicrobial powder coat finish	\$73.00
WBS	Wrought Box Strike	No addition
NOTES:	▲ Options not avail. with a standard 50 function lockout cylinder. † Not avail. with 60, 63, 64 options	
CPC	Clear Powder Coat over 26D/32D - NAC-82280-24V x TRY x RH x 32D x CPC All orders will continue to be handled as a "special" when CPC is ordered.	\$67.00

Experience a safer
and more open world

Copyright © 2002-2021 Sargent Manufacturing Company, an ASSA ABLOY Group company. All rights reserved.
Reproduction in whole or in part without the express written permission of Sargent Manufacturing Company is prohibited.
Contact us at: 800-727-5477 or visit www.sargentlock.com. In Canada contact us at: 800-461-3007 or visit www.assaabloydss.ca

SARGENT®

ASSA ABLOY

**For V Series
Indicators
Click / See
Page ML-1A**

Indicators only available with
NAC-82281 and NAC-82285
when used with PHR option.

ML-35 MORTISE LOCKS

NAC 8200 SERIES

USA & Canada Prices Effective May 1, 2021

TR Rose - 2" Dia • CR Rose - 2-3/16" Dia • G-R-S-Y Levers



TRY shown.

Note: hands required when ordering -G-S-Y Levers

NAC 8200 Electrified Mortise Locks with High Security Monitoring				10BE/26D/ BSP/WSP	03/04/09/10/ 10B/10BL/14/15/ 20D/26
Option	Function	Trim - Proximity Entry	Description		
NAC	82270-12V/-24V	Rose x Lever Design	Fail Safe w/Cylinder Override	\$1,465.00	\$1,489.00
NAC	82271-12V/-24V	Rose x Lever Design	Fail Secure w/Cylinder Override		
NAC	82280-12V/-24V	Rose x Lever Design	Fail Safe w/Deadbolt w/Cyl.Override	\$1,540.00	\$1,564.00
NAC	82281-12V/-24V	Rose x Lever Design	Fail Secure w/D.bolt w/Cyl.Override		
NAC	82274-12V/-24V	Rose x Lever Design	Fail Safe - No Cylinder	\$1,410.00	\$1,434.00
NAC	82275-12V/-24V	Rose x Lever Design	Fail Secure - No Cylinder		
NAC	82284-12V/-24V	Rose x Lever Design	Fail Safe w/Deadbolt - No Cylinder	\$1,485.00	\$1,509.00
NAC	82285-12V/-24V	Rose x Lever Design	Fail Secure w/Deadbolt - No Cylinder		

Note: Consult catalog for ordering information.

Specify hand and voltage (12v or 24v) when ordering

Experience a safer
and more open world

Copyright © 2002-2021 Sargent Manufacturing Company, an ASSA ABLOY Group company. All rights reserved.
Reproduction in whole or in part without the express written permission of Sargent Manufacturing Company is prohibited.
Contact us at: 800-727-5477 or visit www.sargentlock.com. In Canada contact us at: 800-461-3007 or visit www.assaabloydss.ca

ML-36 MORTISE LOCKS

For V Series
Indicators
Click / See
Page ML-1A

SARGENT®

ASSA ABLOY

OPTIONS

USA & Canada Prices Effective May 1, 2021

Options	Description	Price
1▲	8200 Line with 1-1/16" wide front for 1-3/8" doors.	\$62.00
3	Stainless steel hub (not available with 8289, 8291 & 8292 functions)	\$69.00
10▲	SARGENT Signature Key System	\$63.00 / cyl.
11†▲	SARGENT XC Key System (not available with 10, 22, SC, SE options)	No addition
1160	SARGENT XC Large Format Interchangeable Plastic Disposable Construction Core	No addition
1163	SARGENT XC Large Format Interchangeable Core Cylinder - Includes masterkeying charges	\$83.00
1164	SARGENT XC Large Format Interchangeable Construction Core Cylinder	\$83.00
1170	Small Format interchangeable disposable construction core - to accept 7 Pin XC permanent core	No addition
11727P	Small Format interchangeable keyed construction core - to accept 7 Pin XC permanent core	\$75.00
11737P	Small Format interchangeable core - to accept 7 pin XC permanent core	\$75.00 / cyl.
21▲†	SARGENT Construction Key System (lost ball) Standard on all new systems established since 5/1/96	\$16.00 / cyl.
22▲†	SARGENT Construction Key System (split key) To be used on pre-established split key systems only	\$32.00 / cyl.
23	Locksets with flat 4-7/8" ANSI strike	No addition
31	Thick Doors - Extended Lip Required - Specify Length C to E - Cylinders - IMPORTANT- See catalog 7800/8200 option page for cylinder limitations - Below charges DO NOT include additional charges for special cylinder requirements Doors up to 2-1/2" thick - lock centered Doors 2-5/8" to 6" thick OR doors 1-3/4" thick w/max 1" paneling one side. For example: Specify 1-3/4" door with panel (Side) on inside or outside	No addition Non Keyed function \$50.00 Keyed function \$100.00
36	6 Lobe security head screws	\$24.00
37	Spanner head screws	\$17.00
60	SARGENT Large Format Interchangeable Plastic Disposable Construction Core	No addition
63	SARGENT Large Format Interchangeable core cylinder, includes master keying charges	\$83.00 / cyl.
64	SARGENT Large Format Interchangeable Construction Core Cylinder	\$83.00
6573▲†	Small Format 6-Pin Uncombined Core (Refer to CK-12)	\$65.00 / cyl.
65737P▲†	Small Format 7-Pin Uncombined Core (Refer to CK-12)	\$65.00 / cyl.
68	8200 Line furnished with lever handle outside x knob inside (Excludes SLD Detention Knob)	Defaults to 8200 Lever Lock Price
69	8200 Line furnished with lever handle inside x knob outside (Excludes SLD Detention Knob)	Defaults to 8200 Lever Lock Price
70▲†	Small Format Interchangeable disposable plastic construction core	No addition
72▲†	Small Format Interchangeable 6-pin construction core (7-pin with 11 option)	\$75.00
73▲†	Small Format interchangeable core 6-pin Includes MK and GMK keying charges	\$75.00 / cyl
737P▲†	Small Format interchangeable core 7-pin (refer to CK-12 for available keyways) Includes MK and GMK keying charges	\$75.00 / cyl
81▲†	Cylinder to accept Keso (83) and Keso F1 (F183) removable core – no core provided	No addition
F182†	SARGENT Keso Security Cylinder – patented – new key systems	\$91.00 / cyl.
F183▲†	SARGENT Keso Security Removable Core Cylinder – patented – new key systems	\$130.00 / cyl.
82†	SARGENT Keso Security Cylinder (For existing systems only)	\$91.00 / cyl.
83▲†	SARGENT Keso Security Removable Core Cylinder (For existing systems only)	\$130.00 / cyl.
84▲†	SARGENT Keso Security Removable Construction Core Cylinder	See CK-18
85	Tactile Warning - Abrasive coating on inside lever	\$49.00
86	Tactile Warning - Abrasive coating on outside lever	\$49.00
87	Tactile Warning - Abrasive coating on both levers	\$98.00
AV	Anti Vandal Pull Trim (available in 32D finish), (Not available with 8270, 8271, 8272, 8273 functions)	\$229.00
BR	SARGENT Bump Resistant Cylinders (N/A w/10, 22, 30, 60, 63, 64, 70, 72, 73, 737P, KESO, SC, & SE options)	\$25.00 /cyl.
DG1	Patented Degree DG1 Key System	No addition
DG160	Hardware prepared for DG1-6300 Lg. Format IC cores, supplied with temporary plastic construction cores	No addition
DG163	Patented Degree DG1 Large Format Interchangeable Core Cylinder - Includes master keying charges	\$83.00
DG164	Hardware prepared for DG1-6300 Lg. Format IC cores, supplied with temporary keyed construction cores	\$83.00
DG2	Patented Degree DG2 Key System incorporating a locking sidebar	\$63.00/cyl.
DG260	Hardware prepared for DG2-6300 Lg. Format IC cores, supplied with temporary plastic construction cores	No addition
DG263	Patented Degree DG2 Large Format Interchangeable Core Cylinder - Includes master keying charges	\$146.00
DG264	Hardware prepared for DG2-6300 Lg. Format IC cores, supplied with temporary keyed construction cores	\$83.00
DG3	Patented Degree DG3 Key System incorporating a locking sidebar and UL437 listed	\$89.00/cyl.
DG360	Hardware prepared for DG3-6300 Lg. Format IC cores, supplied with temporary plastic construction cores	No addition
DG363	Patented Degree DG3 Large Format Interchangeable Core Cylinder - Includes master keying charges	\$172.00
DG364	Hardware prepared for DG3-6300 Lg. Format IC cores, supplied with temporary keyed construction cores	\$83.00
DX	Deadbolt Monitoring (not available with 50, 74)	\$197.00
LB	Extra large thumbturn	\$18.00
LC	Less Cylinder	-\$96.00/cyl.
LX	Latchbolt Monitor – available with all non-deadbolt functions; not available with DX option	\$200.00
OBS	Open Back Strike	\$79.00
RX	Request to Exit	\$206.00
SC▲†	Schlage "C" Keyway cylinder, (Number 41 Cylinder Only, 0 bitted)	No addition
SE▲†	Schlage "E" Keyway cylinder, (Number 41 Cylinder Only, 0 bitted)	No addition
SG	MicroShield® – an antimicrobial powder coat finish	\$73.00
WBS	Wrought Box Strike	No addition

NOTES: ▲ Options not avail. with a standard 50 function lockout cylinder. † Not avail. with 60, 63, 64 options

CPC	Clear Powder Coat over 26D/32D – 8205 x TEG x RH x 32D x CPC All orders will continue to be handled as a "special" when CPC is ordered.	\$67.00
-----	--	---------

Experience a safer
and more open world

Copyright © 2002-2021 Sargent Manufacturing Company, an ASSA ABLOY Group company. All rights reserved.
Reproduction in whole or in part without the express written permission of Sargent Manufacturing Company is prohibited.
Contact us at: 800-727-5477 or visit www.sargentlock.com. In Canada contact us at: 800-461-3007 or visit www.assaabloydss.ca

ASSA ABLOY

COASTAL SERIES DESIGN - 8200



USA & Canada Prices Effective May 1, 2021

TE Escutcheon • CE Escutcheon • *VN1 Escutcheon • G-R-S-Y Levers

TEG Shown.

Note: hands required when ordering G-S-Y Levers

Function		Finish	
		10BE/26D/BSP/WSP	03/04/09/10/10B/10BL/14/15/20D/26
Single Cyl			
8204	Storeroom or Closet		
8205	Office or Entry	\$1,146.00	\$1,170.00
8237	Classroom		
8255	Office or Entry		
8206	Storeroom or Service		
8231	Utility		
8236	Closet		
8256	Office or Inner Entry	\$1,169.00	\$1,193.00
8257, 8258, 8267	Institutional Privacy		
8289	Holdback		
8291	All Purpose Holdback		
Single Cyl With Deadbolt			
8224	Room Door		
8225	Dormitory or Exit		
8227	Closet or Storeroom		
8228, 8230	Dummy Trim Deadlock	\$1,201.00	\$1,225.00
8235	Storeroom		
8243	Apartment Corridor		
8245	Dormitory or Exit		
8247	Front Door or Apartment Corridor		
8251	Storeroom Deadbolt		
8250	Hotel Guest Lock	\$1,246.00	\$1,270.00
Double Cyl No Deadbolt			
8216	Apartment or Exit or Public Toilet		
8217	Asylum or Institutional		
8238	Classroom Security Intruder	\$1,255.00	\$1,279.00
8242	Classroom Security Intruder Latchbolt		
8259	School Security		
8290	Classroom Security Holdback		
8292	All Purpose Holdback		
Double Cyl With Deadbolt			
8226	Store Door		
8229	Dummy Trim Deadlock		
8239, 8240	Classroom Security Intruder	\$1,283.00	\$1,307.00
8241	Classroom Security		
8246	Dormitory or Exit		
8248	Store Door		
8249	Security Deadbolt		
8252	Institutional		
Electro Mechanical Single Cyl – Specify 12V or 24V			
8270-12V / 8270-24V	Fail Safe	\$1,342.00	\$1,366.00
8271-12V / 8271-24V	Fail Secure		
Electro Mechanical Double Cyl – Specify 12V or 24V			
8272-12V / 8272-24V	Fail Safe	\$1,399.00	\$1,423.00
8273-12V / 8273-24V	Fail Secure		
Non Keyed			
8213	Communication or Exit	\$917.00	\$941.00
8215	Passage or Closet		
8265	Privacy Bedroom or Bath (Latch)	\$1,024.00	\$1,048.00
8266, 8268	Privacy Bedroom or Bath (Deadbolt)	\$1,085.00	\$1,109.00
8293	Single Dummy Trim	\$379.00	\$391.00
8294	Double Dummy Trim	\$756.00	\$780.00
8295	Single Dummy Trim w/Lockbody	\$483.00	\$495.00
8296	Double Dummy Trim w/Lockbody	\$862.00	\$886.00
8297	Double Dummy w/Active Trim	\$950.00	\$974.00

Experience a safer
and more open world

ML-38 MORTISE LOCKS

For V Series
Indicators
Click / See
Page ML-1A

SARGENT®

ASSA ABLOY

OPTION

USA & Canada Prices Effective May 1, 2021

Options	Description	Price
1▲	8200 Line with 1-1/16" wide front for 1-3/8" doors.	\$62.00
3	Stainless steel hub (not available with 8289, 8291 & 8292 functions)	\$69.00
10▲	SARGENT Signature Key System	\$63.00 / cyl.
11†▲	SARGENT XC Key System (not available w/10, KESO, SC, SE)	No addition
1160	SARGENT XC Large Format Interchangeable Plastic Disposable Construction Core	No addition
1163	SARGENT XC Large Format Interchangeable Core Cylinder - Includes masterkeying charges	\$83.00
1164	SARGENT XC Large Format Interchangeable Construction Core Cylinder	\$83.00
1170	Small Format interchangeable disposable construction core - to accept 7 Pin XC permanent core	No addition
11727P	Small Format interchangeable keyed construction core - to accept 7 Pin XC permanent core	\$75.00
11737P	Small Format interchangeable core - to accept 7 pin XC permanent core	\$75.00 / cyl.
21▲†	SARGENT Construction Key System (lost ball) Standard on all new systems established since 5/1/96	\$16.00 / cyl.
22▲†	SARGENT Construction Key System (split key) To be used on pre-established split key systems only	\$32.00 / cyl.
23	Locksets with flat 4 7/8" ANSI strike	No addition
31	Thick Doors - Extended Lip Required - Specify Length C to E IMPORTANT: See 7800/8200 Catalog Option Page for Cylinder Limits - DOES NOT include additional Charges for Special Cylinder Requirements	No addition
	Doors up to 2-1/2" thick - lock centered • Doors 2-5/8" to 6" thick OR doors 1-3/4" thick w/max 1" paneling one side. For example: Specify 1-3/4" door with panel (Side) on inside or outside	Non Keyed function \$50.00 Keyed function \$100.00
36	6 Lobe security head screws	\$24.00
37	Spanner head screws	\$17.00
49	Visual Status Indicator - Available with 30, 36, 37 function - Rose Trims CR, E, L, LN, O, TR - Available with 26, 29, 38, 39 40, 41 functions - Rose Trim 8200 LN	\$140.00
49	Occupancy Indicator with emergency Release - Available with 65, 66, 68 functions; Rose Trims 7800 CR, E, L, LN, O, TR	\$140.00
50	Secured Indicator Rose- doors 1-5/8" to 2-1/4" thick- Avail.w/24,25,26,28,29,30,36,37,38,39,40,41,43,45,50,51,52,57,58,67 functions	\$140.00
60	SARGENT Large Format Interchangeable Plastic Disposable Construction Core	No addition
63	SARGENT Large Format Interchangeable core cylinder, includes master keying charges	\$83.00 / cyl
64	SARGENT Large Format Interchangeable Construction Core Cylinder	\$83.00
6573▲†	Small Format 6-Pin Uncombined Core (Refer to CK-12)	\$65.00 / cyl.
65737P▲†	Small Format 7-Pin Uncombined Core (Refer to CK-12)	\$65.00 / cyl.
68	8200 Line furnished with lever handle outside x knob inside (Excludes SLD Detention Knob)	Defaults to 8200 Lever Lock Price
69	8200 Line furnished with lever handle inside x knob outside (Excludes SLD Detention Knob)	Defaults to 8200 Lever Lock Price
70▲†	Small Format interchangeable disposable plastic construction core	No addition
72▲†	Small Format interchangeable 6-Pin construction core	\$75.00
73▲†	Small Format interchangeable core 6-pin Includes MK and GMK keying charges	\$75.00 / cyl
737P▲†	Small Format interchangeable core 7-pin (refer to CK-12 for available keyways) Includes MK and GMK keying charges	\$75.00 / cyl
81▲†	Cylinder to accept Keso (83) and Keso F1 (F183) removable core - no core provided	No addition
F182†	SARGENT Keso Security Cylinder - patented - new key systems	\$91.00 / cyl.
F183▲†	SARGENT Keso Security Removable Core Cylinder - patented - new key systems	\$130.00 / cyl.
82†	SARGENT Keso Security Cylinder (For existing systems only)	\$91.00 / cyl.
83▲†	SARGENT Keso Security Removable Core Cylinder (For existing systems only)	\$130.00 / cyl.
84▲†	SARGENT Keso Security Removable Construction Core Cylinder	See CK-18
85	Tactile Warning - Abrasive Coating on Inside Lever	\$49.00
86	Tactile Warning - Abrasive Coating on Outside Lever	\$49.00
87	Tactile Warning - Abrasive Coating on Outside & Inside Lever	\$98.00
AV	Anti Vandal Pull Trim (available in 32D finish), (Not available with 8270, 8271, 8272, 8273 functions)	\$229.00
BR	SARGENT Bump Resistant Cylinders (N/A w/10, 22, 30, 60, 63, 64, 70, 72, 73, 737P, KESO, SC, & SE options)	\$25.00 /cyl.
DG1	Patented Degree DG1 Key System	No addition
DG160	Hardware prepared for DG1-6300 Lg. Format IC cores, supplied with temporary plastic construction cores	No addition
DG163	Patented Degree DG1 Large Format Interchangeable Core Cylinder - Includes master keying charges	\$83.00
DG164	Hardware prepared for DG1-6300 Lg. Format IC cores, supplied with temporary keyed construction cores	\$83.00
DG2	Patented Degree DG2 Key System incorporating a locking sidebar	\$63.00/cyl.
DG260	Hardware prepared for DG2-6300 Lg. Format IC cores, supplied with temporary plastic construction cores	No addition
DG263	Patented Degree DG2 Large Format Interchangeable Core Cylinder - Includes master keying charges	\$146.00
DG264	Hardware prepared for DG2-6300 Lg. Format IC cores, supplied with temporary keyed construction cores	\$83.00
DG3	Patented Degree DG3 Key System incorporating a locking sidebar and UL437 listed	\$89.00/cyl.
DG360	Hardware prepared for DG3-6300 Lg. Format IC cores, supplied with temporary plastic construction cores	No addition
DG363	Patented Degree DG3 Large Format Interchangeable Core Cylinder - Includes master keying charges	\$172.00
DG364	Hardware prepared for DG3-6300 Lg. Format IC cores, supplied with temporary keyed construction cores	\$83.00
IDP	Integrated Door Position Switch	\$108.00
LB	Extra large thumbturn	\$18.00
LC	Less Cylinder	-\$96.00/cyl.
OBS	Open Back Strike	\$79.00
PHR	Deadbolt Privacy Function (available w/deadbolt function only)	\$100.00
R01	Mercury and Lenel compatible 1KΩ/2KΩ resistance supervision	\$100.00
R03	Software House compatible 1KΩ/2KΩ resistance supervision	\$100.00
R04	AMAG compatible 4-state supervision	\$100.00
SC▲†	Schlage "C" Keyway cylinder, (Number 41 Cylinder Only, 0 bitted)	No addition
SE▲†	Schlage "E" Keyway cylinder, (Number 41 Cylinder Only, 0 bitted)	No addition
SG	MicroShield® - an antimicrobial powder coat finish	\$73.00
WBS	Wrought Box Strike	No addition
NOTES:	▲ Options not avail. with a standard 50 function lockout cylinder. † Not avail. with 60, 63, 64 options	
CPC	Clear Powder Coat over 26D/32D - NAC-82280-24V x TEG x RH x 32D x CPC All orders will continue to be handled as a "special" when CPC is ordered.	\$67.00

Experience a safer
and more open world

Copyright © 2002-2021 Sargent Manufacturing Company, an ASSA ABLOY Group company. All rights reserved.
Reproduction in whole or in part without the express written permission of Sargent Manufacturing Company is prohibited.
Contact us at: 800-727-5477 or visit www.sargentlock.com. In Canada contact us at: 800-461-3007 or visit www.assaabloydss.ca

SARGENT®

ASSA ABLOY

**For V Series
Indicators
Click / See
Page ML-1A**

Indicators only available with
NAC-82281 and NAC-82285
when used with PHR option.

ML-39 MORTISE LOCKS

NAC 8200 SERIES

USA & Canada Prices Effective May 1, 2021

TE Escutcheon • CE Escutcheon • VN1* Escutcheon • G-R-S-Y Levers

Note: hands required when ordering -G-S-Y Levers

*Note: VN1 escutcheon used with indicator only. Refer to page ML-1A for more information. Indicator option code must be specified.



TEG Shown.

NAC 8200 Electrified Mortise Locks with High Security Monitoring				10BE/26D/ BSP/WSP	03/04/09/10/ 10B/10BL/14/15/ 20D/26
Option	Function	Trim - Proximity Entry	Description		
NAC	82270-12V/-24V	Rose x Lever Design	Fail Safe w/Cylinder Override	\$1,517.00	\$1,541.00
NAC	82271-12V/-24V	Rose x Lever Design	Fail Secure w/Cylinder Override		
NAC	82280-12V/-24V	Rose x Lever Design	Fail Safe w/Deadbolt w/Cyl.Override	\$1,592.00	\$1,616.00
NAC	82281-12V/-24V	Rose x Lever Design	Fail Secure w/D.bolt w/Cyl.Override		
NAC	82274-12V/-24V	Rose x Lever Design	Fail Safe - No Cylinder	\$1,462.00	\$1,486.00
NAC	82275-12V/-24V	Rose x Lever Design	Fail Secure - No Cylinder		
NAC	82284-12V/-24V	Rose x Lever Design	Fail Safe w/Deadbolt - No Cylinder	\$1,537.00	\$1,561.00
NAC	82285-12V/-24V	Rose x Lever Design	Fail Secure w/Deadbolt - No Cylinder		

Note: Consult catalog for ordering information.

Specify hand and voltage (12v or 24v) when ordering

Experience a safer
and more open world

Copyright © 2002-2021 Sargent Manufacturing Company, an ASSA ABLOY Group company. All rights reserved.
Reproduction in whole or in part without the express written permission of Sargent Manufacturing Company is prohibited.
Contact us at: 800-727-5477 or visit www.sargentlock.com. In Canada contact us at: 800-461-3007 or visit www.assaabloydss.ca

ML-40 MORTISE LOCKS

For V Series
Indicators
Click / See
Page ML-1A

SARGENT®

ASSA ABLOY

OPTION

USA & Canada Prices Effective May 1, 2021

Options	Description	Price
1▲	8200 Line with 1-1/16" wide front for 1-3/8" doors.	\$62.00
3	Stainless steel hub (not available with 8289, 8291 & 8292 functions)	\$69.00
10▲	SARGENT Signature Key System	\$63.00 / cyl.
11†▲	SARGENT XC Key System (not available with 10, 22, SC, SE options)	No addition
1160	SARGENT XC Large Format Interchangeable Plastic Disposable Construction Core	No addition
1163	SARGENT XC Large Format Interchangeable Core Cylinder - Includes masterkeying charges	\$83.00
1164	SARGENT XC Large Format Interchangeable Construction Core Cylinder	\$83.00
1170	Small Format interchangeable disposable construction core - to accept 7 Pin XC permanent core	No addition
11727P	Small Format interchangeable keyed construction core - to accept 7 Pin XC permanent core	\$75.00
11737P	Small Format interchangeable core - to accept 7 pin XC permanent core	\$75.00 /cyl.
21▲†	SARGENT Construction Key System (lost ball) Standard on all new systems established since 5/1/96	\$16.00 / cyl.
22▲†	SARGENT Construction Key System (split key) To be used on pre-established split key systems only	\$32.00 / cyl.
23	Locksets with flat 4 7/8" ANSI strike	No addition
31	Thick Doors - Extended Lip Required - Specify Length C to E - Cylinders - IMPORTANT- See catalog 7800/8200 option page for cylinder limitations - Below charges DO NOT include additional charges for special cylinder requirements Doors up to 2-1/2" thick - lock centered Doors 2-5/8" to 6" thick OR doors 1-3/4" thick w/max 1" paneling one side. For example: Specify 1-3/4" door with panel (Side) on inside or outside	No addition Non Keyed function \$50.00 Keyed function \$100.00
49	Visual Status Indicator - Available with 30, 36, 37 function - Rose Trims CR, E, L, LN, O, TR - Available with 26, 29, 38, 39 40, 41 functions - Rose Trim 8200 LN	\$140.00
49	Occupancy Indicator with emergency Release - Available with 65, 66, 68 functions; Rose Trims 7800 CR, E, L, LN, O, TR	\$140.00
50	Secured Indicator Rose- doors 1-5/8" to 2-1/4" thick- Avail.w/24,25,26,28,29,30,36,37,38,39,40,41,43,45,50,51,52,57,58,67 functions	\$140.00
60	SARGENT Large Format Interchangeable Plastic Disposable Construction Core	No addition
63	SARGENT Large Format Interchangeable core cylinder, includes master keying charges	\$83.00 / cyl.
64	SARGENT Large Format Interchangeable Construction Core Cylinder	\$83.00
6573▲†	Small Format 6-Pin Uncombined Core (Refer to CK-12)	\$65.00 / cyl.
65737P▲†	Small Format 7-Pin Uncombined Core (Refer to CK-12)	\$65.00 / cyl.
68	8200 Line furnished with lever handle outside x knob inside (Excludes SLD Detention Knob)	Defaults to 8200 Lever Lock Price
69	8200 Line furnished with lever handle inside x knob outside (Excludes SLD Detention Knob)	Defaults to 8200 Lever Lock Price
70▲†	Small Format interchangeable disposable plastic construction core	No addition
72▲†	Small Format interchangeable 6-pin construction core (7-pin with 11 option)	\$75.00
73▲†	Small Format 6-pin interchangeable core (refer to CK-8 for available keyways)	\$75.00 / cyl
737P▲†	Small Format interchangeable core (refer to CK 8 for available keyways)	\$75.00 / cyl
74	Lock case wrapped in lead - handing required (roses not available)	\$294.00
81▲†	Cylinder to accept Keso (83) and Keso F1 (F183) removable core - no core provided	No addition
F182†	SARGENT Keso Security Cylinder - patented - new key systems	\$91.00 / cyl.
F183▲†	SARGENT Keso Security Removable Core Cylinder - patented - new key systems	\$130.00 / cyl.
82†	SARGENT Keso Security Cylinder (For existing systems only)	\$91.00 / cyl.
83▲†	SARGENT Keso Security Removable Core Cylinder (For existing systems only)	\$130.00 / cyl.
84▲†	SARGENT Keso Security Removable Construction Core Cylinder	See CK-18
85	Tactile Warning - Abrasive coating on inside lever	\$49.00
86	Tactile Warning - Abrasive coating on outside lever	\$49.00
87	Tactile Warning - Abrasive coating on both levers	\$98.00
AV	Anti Vandal Pull Trim (available in 32D finish), (Not available with 8270, 8271, 8272, 8273 functions)	\$229.00
BR	SARGENT Bump Resistant Cylinders (N/A w/10, 22, 30, 60, 63, 64, 70, 72, 73, 737P, KESO, SC, & SE options)	\$25.00 /cyl.
DG1	Patented Degree DG1 Key System	No addition
DG160	Hardware prepared for DG1-6300 Lg. Format IC cores, supplied with temporary plastic construction cores	No addition
DG163	Patented Degree DG1 Large Format Interchangeable Core Cylinder - Includes master keying charges	\$83.00
DG164	Hardware prepared for DG1-6300 Lg. Format IC cores, supplied with temporary keyed construction cores	\$83.00
DG2	Patented Degree DG2 Key System incorporating a locking sidebar	\$63.00/cyl.
DG260	Hardware prepared for DG2-6300 Lg. Format IC cores, supplied with temporary plastic construction cores	No addition
DG263	Patented Degree DG2 Large Format Interchangeable Core Cylinder - Includes master keying charges	\$146.00
DG264	Hardware prepared for DG2-6300 Lg. Format IC cores, supplied with temporary keyed construction cores	\$83.00
DG3	Patented Degree DG3 Key System incorporating a locking sidebar and UL437 listed	\$89.00/cyl.
DG360	Hardware prepared for DG3-6300 Lg. Format IC cores, supplied with temporary plastic construction cores	No addition
DG363	Patented Degree DG3 Large Format Interchangeable Core Cylinder - Includes master keying charges	\$172.00
DG364	Hardware prepared for DG3-6300 Lg. Format IC cores, supplied with temporary keyed construction cores	\$83.00
DX	Deadbolt Monitoring (not available with 50, 74)	\$197.00
LC	Less Cylinder	-\$96.00/cyl.
LB	Extra large thumbturn	\$18.00
LX	Latchbolt Monitor - available with all non-deadbolt functions; not available with DX option	\$200.00
OBS	Open Back Strike	\$79.00
RX	Request to Exit	\$206.00
SC▲†	Schlage "C" Keyway cylinder, (Number 41 Cylinder Only, 0 bitted)	No addition
SE▲†	Schlage "E" Keyway cylinder, (Number 41 Cylinder Only, 0 bitted)	No addition
SG	MicroShield® - an antimicrobial powder coat finish	\$73.00
T1	Decorative thumbturn; backplate matches rose design chosen	No Addition
T2	Decorative square thumbturn; backplate matches rose design chosen	No Addition
T3	Decorative cylinder thumbturn; backplate matches rose design chosen	No Addition
WBS	Wrought Box Strike	No addition

NOTES: ▲ Options not avail. with a standard 50 function lockout cylinder. † Not avail. with 60, 63, 64 options

CPC	Clear Powder Coat over 26D/32D - 8205 x CRH001 x RH x 32D x CPC All orders will continue to be handled as a "special" when CPC is ordered.	\$67.00
-----	---	---------

Experience a safer
and more open world

Copyright © 2002-2021 Sargent Manufacturing Company, an ASSA ABLOY Group company. All rights reserved.
Reproduction in whole or in part without the express written permission of Sargent Manufacturing Company is prohibited.
Contact us at: 800-727-5477 or visit www.sargentlock.com. In Canada contact us at: 800-461-3007 or visit www.assaabloydss.ca

ASSA ABLOY

8200 STUDIO COLLECTION WOOSTER SQUARE

Rose Design:

CO (2-3/4")
CR (2-3/16")
LN (2")
O (2-3/4")
TO (2-3/4")
TR (2-3/16")
E2 (2-11/16")
E3 (2-1/16")
E4 (3-1/4")

Lever Design:

H001, H002



H001



H002

How to order:

21-8205 x E4H001 x RH x 10BE
Option 21
Function 8205
Rose E4
Lever H001
Hand RH
Finish 10BE

USA & Canada Prices Effective May 1, 2021

Function		Finish	
		10BE/26D/BSP/WSP	03/04/09/10/10B/10BL/14/15/20D/26/32/32D
Single Cyl			
8204	Storeroom or Closet		
8205	Office or Entry	\$1,187.00	\$1,211.00
8237	Classroom		
8255	Office or Entry		
8206	Storeroom or Service		
8231	Utility		
8236	Closet		
8256	Office or Inner Entry	\$1,211.00	\$1,235.00
8257, 8258, 8267	Institutional Privacy		
8289	Holdback		
8291	All Purpose Holdback		
Single Cyl With Deadbolt			
8224	Room Door		
8225	Dormitory or Exit		
8227	Closet or Storeroom		
8228, 8230	Dummy Trim Deadlock	\$1,239.00	\$1,263.00
8235	Storeroom		
8243	Apartment Corridor		
8245	Dormitory or Exit		
8247	Front Door or Apartment Corridor		
8251	Storeroom Deadbolt		
8250	Hotel Guest Lock	\$1,279.00	\$1,303.00
Double Cyl No Deadbolt			
8216	Apartment or Exit or Public Toilet		
8217	Asylum or Institutional		
8238	Classroom Security Intruder	\$1,290.00	\$1,314.00
8242	Classroom Security Intruder Latchbolt		
8259	School Security		
8290	Classroom Security Holdback		
8292	All Purpose Holdback		
Double Cyl With Deadbolt			
8226	Store Door		
8229	Dummy Trim Deadlock		
8239, 8240	Classroom Security Intruder		
8241	Classroom Security		
8246	Dormitory or Exit	\$1,314.00	\$1,338.00
8248	Store Door		
8249	Security Deadbolt		
8252	Institutional		
Electro Mechanical Single Cyl – Specify 12V or 24V			
8270-12V / 8270-24V	Fail Safe	\$1,383.00	\$1,407.00
8271-12V / 8271-24V	Fail Secure		
Electro Mechanical Double Cyl – Specify 12V or 24V			
8272-12V / 8272-24V	Fail Safe	\$1,440.00	\$1,464.00
8273-12V / 8273-24V	Fail Secure		
Non Keyed			
8213	Communication or Exit	\$1,020.00	\$1,044.00
8215	Passage or Closet		
8265	Privacy Bedroom or Bath (Latch)	\$1,129.00	\$1,153.00
8266, 8268	Privacy Bedroom or Bath (Deadbolt)	\$1,166.00	\$1,190.00
8293*	Single Dummy Trim	\$408.00	\$432.00
8294	Double Dummy Trim	\$836.00	\$860.00
8295	Single Dummy Trim w/Lockbody	\$506.00	\$530.00
8296	Double Dummy Trim w/Lockbody	\$934.00	\$958.00
8297	Double Dummy w/Active Trim	\$1,020.00	\$1,044.00

ML-42 MORTISE LOCKS

For V Series
Indicators
Click / See
Page ML-1A

SARGENT®

ASSA ABLOY

OPTION

USA & Canada Prices Effective May 1, 2021

Options	Description	Price
1▲	8200 Line with 1-1/16" wide front for 1-3/8" doors.	\$62.00
3	Stainless steel hub (not available with 8289, 8291 & 8292 functions)	\$69.00
10▲	SARGENT Signature Key System	\$63.00 / cyl.
11†▲	SARGENT XC Key System (not available with 10, 22, SC, SE options)	No addition
1160	SARGENT XC Large Format Interchangeable Plastic Disposable Construction Core	No addition
1163	SARGENT XC Large Format Interchangeable Core Cylinder - Includes masterkeying charges	\$83.00
1164	SARGENT XC Large Format Interchangeable Construction Core Cylinder	\$83.00
1170	Small Format interchangeable disposable construction core - to accept 7 Pin XC permanent core	No addition
11727P	Small Format interchangeable keyed construction core - to accept 7 Pin XC permanent core	\$75.00
11737P	Small Format interchangeable core - to accept 7 pin XC permanent core	\$75.00 /cyl.
21▲†	SARGENT Construction Key System (lost ball) Standard on all new systems established since 5/1/96	\$16.00 / cyl.
22▲†	SARGENT Construction Key System (split key) To be used on pre-established split key systems only	\$32.00 / cyl.
23	Locksets with flat 4-7/8" ANSI strike	No addition
31	Thick Doors - Extended Lip Required - Specify Length C to E - Cylinders - IMPORTANT- See catalog 7800/8200 option page for cylinder limitations - Below charges DO NOT include additional charges for special cylinder requirements Doors up to 2-1/2" thick - lock centered Doors 2-5/8" to 6" thick OR doors 1-3/4" thick w/max 1" paneling one side. For example: Specify 1-3/4" door with panel (Side) on inside or outside	No addition Non Keyed function \$50.00 Keyed function \$100.00
49	Visual Status Indicator - Available with 30, 36, 37 function - Rose Trims CR, E, L, LN, O, TR - Available with 26, 29, 38, 39 40, 41 functions - Rose Trim 8200 LN	\$140.00
49	Occupancy Indicator with emergency Release - Available with 65, 66, 68 functions; Rose Trims 7800 CR, E, L, LN, O, TR	\$140.00
50	Secured Indicator Rose- doors 1-5/8" to 2-1/4" thick- Avail.w/24,25,26,28,29,30,36,37,38,39,40,41,43,45,50,51,52,57,58,67 functions	\$140.00
60	SARGENT Large Format Interchangeable Plastic Disposable Construction Core	No addition
63	SARGENT Large Format Interchangeable core cylinder, includes master keying charges	\$83.00 / cyl.
64	SARGENT Large Format Interchangeable Construction Core Cylinder	\$83.00
6573▲†	Small Format 6-Pin Uncombined Core (Refer to CK-12)	\$65.00 / cyl.
65737P▲†	Small Format 7-Pin Uncombined Core (Refer to CK-12)	\$65.00 / cyl.
68	8200 Line furnished with lever handle outside x knob inside (Excludes SLD Detention Knob)	Defaults to 8200 Lever Lock Price
69	8200 Line furnished with lever handle inside x knob outside (Excludes SLD Detention Knob)	Defaults to 8200 Lever Lock Price
70▲†	Small Format Interchangeable disposable plastic construction core	No addition
72▲†	Small Format Interchangeable 6-pin construction core (7-pin with 11 option)	\$75.00
73▲†	Small Format 6-pin interchangeable core (refer to CK-8 for available keyways)	\$75.00 / cyl
737P▲†	Small Format Interchangeable core (refer to CK 8 for available keyways)	\$75.00 / cyl
74	Lock case wrapped in lead - handing required (roses not available)	\$294.00
81▲†	Cylinder to accept Keso (83) and Keso F1 (F183) removable core - no core provided	No addition
F182†	SARGENT Keso Security Cylinder - patented - new key systems	\$91.00 / cyl.
F183▲†	SARGENT Keso Security Removable Core Cylinder - patented - new key systems	\$130.00 / cyl.
82†	SARGENT Keso Security Cylinder (For existing systems only)	\$91.00 / cyl.
83▲†	SARGENT Keso Security Removable Core Cylinder (For existing systems only)	\$130.00 / cyl.
84▲†	SARGENT Keso Security Removable Construction Core Cylinder	See CK-18
85	Tactile Warning - Abrasive coating on inside lever	\$49.00
86	Tactile Warning - Abrasive coating on outside lever	\$49.00
87	Tactile Warning - Abrasive coating on both levers	\$98.00
AV	Anti Vandal Pull Trim (available in 32D finish), (Not available with 8270, 8271, 8272, 8273 functions)	\$229.00
BR	SARGENT Bump Resistant Cylinders (N/A w/10, 22, 30, 60, 63, 64, 70, 72, 73, 737P, KESO, SC, & SE options)	\$25.00 /cyl.
DG1	Patented Degree DG1 Key System	No addition
DG160	Hardware prepared for DG1-6300 Lg. Format IC cores, supplied with temporary plastic construction cores	No addition
DG163	Patented Degree DG1 Large Format Interchangeable Core Cylinder - Includes master keying charges	\$83.00
DG164	Hardware prepared for DG1-6300 Lg. Format IC cores, supplied with temporary keyed construction cores	\$83.00
DG2	Patented Degree DG2 Key System incorporating a locking sidebar	\$63.00/cyl.
DG260	Hardware prepared for DG2-6300 Lg. Format IC cores, supplied with temporary plastic construction cores	No addition
DG263	Patented Degree DG2 Large Format Interchangeable Core Cylinder - Includes master keying charges	\$146.00
DG264	Hardware prepared for DG2-6300 Lg. Format IC cores, supplied with temporary keyed construction cores	\$83.00
DG3	Patented Degree DG3 Key System incorporating a locking sidebar and UL437 listed	\$89.00/cyl.
DG360	Hardware prepared for DG3-6300 Lg. Format IC cores, supplied with temporary plastic construction cores	No addition
DG363	Patented Degree DG3 Large Format Interchangeable Core Cylinder - Includes master keying charges	\$172.00
DG364	Hardware prepared for DG3-6300 Lg. Format IC cores, supplied with temporary keyed construction cores	\$83.00
IDP	Integrated door position switch	\$108.00
LC	Less Cylinder	-\$96.00/cyl.
LB	Extra large thumbturn	\$18.00
OBS	Open Back Strike	\$79.00
PHR	Deadbolt Privacy Function (available w/deadbolt function only)	\$100.00
R01	Mercury and Lenel compatible 1KΩ/2KΩ resistance supervision	\$100.00
R03	Software House compatible 1KΩ/2KΩ resistance supervision	\$100.00
R04	AMAG compatible 4-state supervision	\$100.00
SC▲†	Schlage "C" Keyway cylinder, (Number 41 Cylinder Only, 0 bitted)	No addition
SE▲†	Schlage "E" Keyway cylinder, (Number 41 Cylinder Only, 0 bitted)	No addition
SG	MicroShield® - an antimicrobial powder coat finish	\$73.00
T1	Decorative thumbturn; backplate matches rose design chosen	No Addition
T2	Decorative square thumbturn; backplate matches rose design chosen	No Addition
T3	Decorative cylinder thumbturn; backplate matches rose design chosen	No Addition
WBS	Wrought Box Strike	No addition

NOTES: ▲ Options not avail. with a standard 50 function lockout cylinder. † Not avail. with 60, 63, 64 options

CPC	Clear Powder Coat over 26D/32D - 8205 x CRH001 x RH x 32D x CPC All orders will continue to be handled as a "special" when CPC is ordered.	\$67.00
-----	---	---------

Experience a safer
and more open world

Copyright © 2002-2021 Sargent Manufacturing Company, an ASSA ABLOY Group company. All rights reserved.
Reproduction in whole or in part without the express written permission of Sargent Manufacturing Company is prohibited.
Contact us at: 800-727-5477 or visit www.sargentlock.com. In Canada contact us at: 800-461-3007 or visit www.assaabloydss.ca

ASSA ABLOY

8200 STUDIO COLLECTION WOOSTER SQUARE

Rose Design:

CO (2-3/4")
CR (2-3/16")
LN (2")
O (2-3/4")
TO (2-3/4")
TR (2-3/16")
E2 (2-11/16")
E3 (2-1/16")
E4 (3-1/4")

Lever Design:

H001, H002



H001



H002

How to order:

21-8205 x E4H001 x RH x 10BE
Option 21
Function 8205
Rose E4
Lever H001
Hand RH
Finish 10BE

USA & Canada Prices Effective
May 1, 2021

NAC 8200 Electrified Mortise Locks with High Security Monitoring				10BE/26D/ BSP/WSP	03/04/09/10/ 10B/10BL/14/15/ 20D/26
Option	Function	Trim - Proximity Entry	Description		
NAC	82270-12V/-24V	Rose x Lever Design	Fail Safe w/Cylinder Override	\$1,558.00	\$1,582.00
NAC	82271-12V/-24V	Rose x Lever Design	Fail Secure w/Cylinder Override		
NAC	82280-12V/-24V	Rose x Lever Design	Fail Safe w/Deadbolt w/Cyl.Override	\$1,633.00	\$1,657.00
NAC	82281-12V/-24V	Rose x Lever Design	Fail Secure w/D.bolt w/Cyl.Override		
NAC	82274-12V/-24V	Rose x Lever Design	Fail Safe - No Cylinder	\$1,503.00	\$1,527.00
NAC	82275-12V/-24V	Rose x Lever Design	Fail Secure - No Cylinder		
NAC	82284-12V/-24V	Rose x Lever Design	Fail Safe w/Deadbolt - No Cylinder	\$1,578.00	\$1,602.00
NAC	82285-12V/-24V	Rose x Lever Design	Fail Secure w/Deadbolt - No Cylinder		

Note: Consult catalog for ordering information.

Specify hand and voltage (12v or 24v) when ordering

ML-44 MORTISE LOCKS

For V Series
Indicators
Click / See
Page ML-1A

SARGENT®

ASSA ABLOY

OPTION

USA & Canada Prices Effective May 1, 2021

Options	Description	Price
1▲	8200 Line with 1-1/16" wide front for 1-3/8" doors.	\$62.00
3	Stainless steel hub (not available with 8289, 8291 & 8292 functions)	\$69.00
10▲	SARGENT Signature Key System	\$63.00 / cyl.
11†▲	SARGENT XC Key System (not available with 10, 22, SC, SE options)	No addition
1160	SARGENT XC Large Format Interchangeable Plastic Disposable Construction Core	No addition
1163	SARGENT XC Large Format Interchangeable Core Cylinder - Includes masterkeying charges	\$83.00
1164	SARGENT XC Large Format Interchangeable Construction Core Cylinder	\$83.00
1170	Small Format interchangeable disposable construction core - to accept 7 Pin XC permanent core	No addition
11727P	Small Format interchangeable keyed construction core - to accept 7 Pin XC permanent core	\$75.00
11737P	Small Format interchangeable core - to accept 7 pin XC permanent core	\$75.00 / cyl.
21▲†	SARGENT Construction Key System (lost ball) Standard on all new systems established since 5/1/96	\$16.00 / cyl.
22▲†	SARGENT Construction Key System (split key) To be used on pre-established split key systems only	\$32.00 / cyl.
23	Locksets with flat 4 7/8" ANSI strike	No addition
31	Thick Doors - Extended Lip Required - Specify Length C to E - Cylinders - IMPORTANT- See catalog 7800/8200 option page for cylinder limitations - Below charges DO NOT include additional charges for special cylinder requirements	No addition
	Doors up to 2-1/2" thick - lock centered	No addition
	Doors 2-5/8" to 6" thick OR doors 1-3/4" thick w/max 1" paneling one side. For example: Specify 1-3/4" door with panel (Side) on inside or outside	Non Keyed function \$50.00 Keyed function \$100.00
49	Visual Status Indicator - Available with 30, 36, 37 function - Rose Trims CR, E, L, LN, O, TR - Available with 26, 29, 38, 39 40, 41 functions - Rose Trim 8200 LN	\$140.00
49	Occupancy Indicator with emergency Release - Available with 65, 66, 68 functions; Rose Trims 7800 CR, E, L, LN, O, TR	\$140.00
50	Secured Indicator Rose- doors 1-5/8" to 2-1/4" thick- Avail.w/24,25,26,28,29,30,36,37,38,39,40,41,43,45,50,51,52,57,58,67 functions	\$140.00
60	SARGENT Large Format Interchangeable Plastic Disposable Construction Core	No addition
63	SARGENT Large Format Interchangeable core cylinder, includes master keying charges	\$83.00 / cyl.
64	SARGENT Large Format Interchangeable Construction Core Cylinder	\$83.00
6573▲†	Small Format 6-Pin Uncombined Core (Refer to CK-12)	\$65.00 / cyl.
65737P▲†	Small Format 7-Pin Uncombined Core (Refer to CK-12)	\$65.00 / cyl.
68	8200 Line furnished with lever handle outside x knob inside (Excludes SLD Detention Knob)	Defaults to 8200 Lever Lock Price
69	8200 Line furnished with lever handle inside x knob outside (Excludes SLD Detention Knob)	Defaults to 8200 Lever Lock Price
70▲†	Small Format interchangeable disposable plastic construction core	No addition
72▲†	Small Format Interchangeable 6-pin construction core (7-pin with 11 option)	See CK-2
73▲†	Small Format 6-pin interchangeable core (refer to CK-8 for available keyways)	\$75.00 / cyl
737P▲†	Small Format interchangeable core (refer to CK 8 for available keyways)	\$75.00 / cyl
74	Lock case wrapped in lead - handing required (roses not available)	\$294.00
81▲†	Cylinder to accept Keso (83) and Keso F1 (F183) removable core - no core provided	No addition
F182†	SARGENT Keso Security Cylinder - patented - new key systems	\$91.00 / cyl.
F183▲†	SARGENT Keso Security Removable Core Cylinder - patented - new key systems	\$130.00 / cyl.
82†	SARGENT Keso Security Cylinder (For existing systems only)	\$91.00 / cyl.
83▲†	SARGENT Keso Security Removable Core Cylinder (For existing systems only)	\$130.00 / cyl.
84▲†	SARGENT Keso Security Removable Construction Core Cylinder	See CK-18
85	Tactile Warning - Abrasive coating on inside lever	\$49.00
86	Tactile Warning - Abrasive coating on outside lever	\$49.00
87	Tactile Warning - Abrasive coating on both levers	\$98.00
AV	Anti Vandal Pull Trim (available in 32D finish), (Not available with 8270, 8271, 8272, 8273 functions)	\$229.00
BR	SARGENT Bump Resistant Cylinders (N/A w/10, 22, 30, 60, 63, 64, 70, 72, 73, 737P, KESO, SC, & SE options)	\$25.00 /cyl.
DG1	Patented Degree DG1 Key System	No addition
DG160	Hardware prepared for DG1-6300 Lg. Format IC cores, supplied with temporary plastic construction cores	No addition
DG163	Patented Degree DG1 Large Format Interchangeable Core Cylinder - Includes master keying charges	\$83.00
DG164	Hardware prepared for DG1-6300 Lg. Format IC cores, supplied with temporary keyed construction cores	\$83.00
DG2	Patented Degree DG2 Key System incorporating a locking sidebar	\$63.00/cyl.
DG260	Hardware prepared for DG2-6300 Lg. Format IC cores, supplied with temporary plastic construction cores	No addition
DG263	Patented Degree DG2 Large Format Interchangeable Core Cylinder - Includes master keying charges	\$146.00
DG264	Hardware prepared for DG2-6300 Lg. Format IC cores, supplied with temporary keyed construction cores	\$83.00
DG3	Patented Degree DG3 Key System incorporating a locking sidebar and UL437 listed	\$89.00/cyl.
DG360	Hardware prepared for DG3-6300 Lg. Format IC cores, supplied with temporary plastic construction cores	No addition
DG363	Patented Degree DG3 Large Format Interchangeable Core Cylinder - Includes master keying charges	\$172.00
DG364	Hardware prepared for DG3-6300 Lg. Format IC cores, supplied with temporary keyed construction cores	\$83.00
DX	Deadbolt Monitoring (not available with 50, 74)	\$197.00
LC	Less Cylinder	-\$96.00/cyl.
LB	Extra large thumbturn	\$18.00
LX	Latchbolt Monitor - available with all non-deadbolt functions; not available with DX option	\$200.00
OBS	Open Back Strike	\$79.00
RX	Request to Exit	\$206.00
SC▲†	Schlage "C" Keyway cylinder, (Number 41 Cylinder Only, 0 bitted)	No addition
SE▲†	Schlage "E" Keyway cylinder, (Number 41 Cylinder Only, 0 bitted)	No addition
SG	MicroShield® - an antimicrobial powder coat finish	\$73.00
T1	Decorative thumbturn; backplate matches rose design chosen	No Addition
T2	Decorative square thumbturn; backplate matches rose design chosen	No Addition
T3	Decorative cylinder thumbturn; backplate matches rose design chosen	No Addition
WBS	Wrought Box Strike	No addition

NOTES: ▲ Options not avail. with a standard 50 function lockout cylinder. † Not avail. with 60, 63, 64 options

CPC Clear Powder Coat over 26D/32D - 8205 x CRH004 x RH x 32D x CPC \$67.00
All orders will continue to be handled as a "special" when CPC is ordered.

Experience a safer
and more open world

Copyright © 2002-2021 Sargent Manufacturing Company, an ASSA ABLOY Group company. All rights reserved.
Reproduction in whole or in part without the express written permission of Sargent Manufacturing Company is prohibited.
Contact us at: 800-727-5477 or visit www.sargentlock.com. In Canada contact us at: 800-461-3007 or visit www.assaabloydss.ca

ASSA ABLOY

8200 STUDIO COLLECTION WOOSTER SQUARE & GRANT PARK

Rose Design:

CO (2-3/4")
CR (2-3/16")
LN (2")
O (2-3/4")
TO (2-3/4")
TR (2-3/16")
E2 (2-11/16")
E3 (2-1/16")
E4 (3-1/4")

Lever Design:

H003, H004, H005, H006, H007,
*H008, H009, H010, H011



H004



H005

How to order:

21-8205 x E4H003 x RH x 10BE
Option 21
Function 8205
Rose E4
Lever H003
Hand RH
Finish 10BE

USA & Canada Prices Effective May 1, 2021

* Handed - specify hand when ordering.

Function	Finish	
	10BE/26D/BSP/WSP	03/04/09/10/10B/10BL/14/15/20D/26/32/32D
Single Cyl		
8204 Storeroom or Closet		
8205 Office or Entry	\$1,274.00	\$1,298.00
8237 Classroom		
8255 Office or Entry		
8206 Storeroom or Service		
8231 Utility		
8236 Closet		
8256 Office or Inner Entry	\$1,299.00	\$1,323.00
8257, 8258, 8267 Institutional Privacy		
8289 Holdback		
8291 All Purpose Holdback		
Single Cyl With Deadbolt		
8224 Room Door		
8225 Dormitory or Exit		
8227 Closet or Storeroom		
8228, 8230 Dummy Trim Deadlock		
8235 Storeroom	\$1,329.00	\$1,353.00
8243 Apartment Corridor		
8245 Dormitory or Exit		
8247 Front Door or Apartment Corridor		
8251 Storeroom Deadbolt		
8250 Hotel Guest Lock	\$1,368.00	\$1,392.00
Double Cyl No Deadbolt		
8216 Apartment or Exit or Public Toilet		
8217 Asylum or Institutional		
8238 Classroom Security Intruder		
8242 Classroom Security Intruder Latchbolt	\$1,378.00	\$1,402.00
8259 School Security		
8290 Classroom Security Holdback		
8292 All Purpose Holdback		
Double Cyl With Deadbolt		
8226 Store Door		
8229 Dummy Trim Deadlock		
8239, 8240 Classroom Security Intruder		
8241 Classroom Security	\$1,400.00	\$1,424.00
8246 Dormitory or Exit		
8248 Store Door		
8249 Security Deadbolt		
8252 Institutional		
Electro Mechanical Single Cyl – Specify 12V or 24V		
8270-12V / 8270-24V Fail Safe	\$1,470.00	\$1,494.00
8271-12V / 8271-24V Fail Secure		
Electro Mechanical Double Cyl – Specify 12V or 24V		
8272-12V / 8272-24V Fail Safe	\$1,527.00	\$1,551.00
8273-12V / 8273-24V Fail Secure		
Non Keyed		
8213 Communication or Exit	\$1,108.00	\$1,132.00
8215 Passage or Closet		
8265 Privacy Bedroom or Bath (Latch)	\$1,214.00	\$1,238.00
8266, 8268 Privacy Bedroom or Bath (Deadbolt)	\$1,255.00	\$1,279.00
8293* Single Dummy Trim	\$494.00	\$518.00
8294 Double Dummy Trim	\$925.00	\$949.00
8295 Single Dummy Trim w/Lockbody	\$593.00	\$617.00
8296 Double Dummy Trim w/Lockbody	\$1,021.00	\$1,045.00
8297 Double Dummy w/Active Trim	\$1,108.00	\$1,132.00

Experience a safer
and more open world

ML-46 MORTISE LOCKS

For V Series
Indicators
Click / See
Page ML-1A

SARGENT®

ASSA ABLOY

OPTION

USA & Canada Prices Effective May 1, 2021

Options	Description	Price
1▲	8200 Line with 1-1/16" wide front for 1-3/8" doors.	\$62.00
3	Stainless steel hub (not available with 8289, 8291 & 8292 functions)	\$69.00
10▲	SARGENT Signature Key System	\$63.00 / cyl.
11†▲	SARGENT XC Key System (not available with 10, 22, SC, SE options)	No addition
1160	SARGENT XC Large Format Interchangeable Plastic Disposable Construction Core	No addition
1163	SARGENT XC Large Format Interchangeable Core Cylinder - Includes masterkeying charges	\$83.00
1164	SARGENT XC Large Format Interchangeable Construction Core Cylinder	\$83.00
1170	Small Format interchangeable disposable construction core - to accept 7 Pin XC permanent core	No addition
11727P	Small Format interchangeable keyed construction core - to accept 7 Pin XC permanent core	\$75.00
11737P	Small Format interchangeable core - to accept 7 pin XC permanent core	\$75.00 /cyl.
21▲†	SARGENT Construction Key System (lost ball) Standard on all new systems established since 5/1/96	\$16.00 / cyl.
22▲†	SARGENT Construction Key System (split key) To be used on pre-established split key systems only	\$32.00 / cyl.
23	Locksets with flat 4 7/8" ANSI strike	No addition
31	Thick Doors - Extended Lip Required - Specify Length C to E - Cylinders - IMPORTANT- See catalog 7800/8200 option page for cylinder limitations - Below charges DO NOT include additional charges for special cylinder requirements Doors up to 2-1/2" thick - lock centered Doors 2-5/8" to 6" thick OR doors 1-3/4" thick w/max 1" paneling one side. For example: Specify 1-3/4" door with panel (Side) on inside or outside	No addition Non Keyed function \$50.00 Keyed function \$100.00
49	Visual Status Indicator - Available with 30, 36, 37 function - Rose Trims CR, E, L, LN, O, TR - Available with 26, 29, 38, 39 40, 41 functions - Rose Trim 8200 LN	\$140.00
49	Occupancy Indicator with emergency Release - Available with 65, 66, 68 functions; Rose Trims 7800 CR, E, L, LN, O, TR	\$140.00
50	Secured Indicator Rose- doors 1-5/8" to 2-1/4" thick- Avail.w/24,25,26,28,29,30,36,37,38,39,40,41,43,45,50,51,52,57,58,67 functions	\$140.00
60	SARGENT Large Format Interchangeable Plastic Disposable Construction Core	No addition
63	SARGENT Large Format Interchangeable core cylinder, includes master keying charges	\$83.00 / cyl.
64	SARGENT Large Format Interchangeable Construction Core Cylinder	\$83.00
6573▲†	Small Format 6-Pin Uncombined Core (Refer to CK-12)	\$65.00 / cyl.
65737P▲†	Small Format 7-Pin Uncombined Core (Refer to CK-12)	\$65.00 / cyl.
68	8200 Line furnished with lever handle outside x knob inside (Excludes SLD Detention Knob)	Defaults to 8200 Lever Lock Price
69	8200 Line furnished with lever handle inside x knob outside (Excludes SLD Detention Knob)	Defaults to 8200 Lever Lock Price
70▲†	Small Format Interchangeable disposable plastic construction core	No addition
72▲†	Small Format Interchangeable 6-pin construction core (7-pin with 11 option)	\$75.00
73▲†	Small Format 6-pin interchangeable core (refer to CK-8 for available keyways)	\$75.00 / cyl
737P▲†	Small Format Interchangeable core (refer to CK 8 for available keyways)	\$75.00 / cyl
74	Lock case wrapped in lead - handing required (roses not available)	\$294.00
81▲†	Cylinder to accept Keso (83) and Keso F1 (F183) removable core - no core provided	No addition
F182†	SARGENT Keso Security Cylinder - patented - new key systems	\$91.00 / cyl.
F183▲†	SARGENT Keso Security Removable Core Cylinder - patented - new key systems	\$130.00 / cyl.
82†	SARGENT Keso Security Cylinder (For existing systems only)	\$91.00 / cyl.
83▲†	SARGENT Keso Security Removable Core Cylinder (For existing systems only)	\$130.00 / cyl.
84▲†	SARGENT Keso Security Removable Construction Core Cylinder	See CK-18
85	Tactile Warning - Abrasive coating on inside lever	\$49.00
86	Tactile Warning - Abrasive coating on outside lever	\$49.00
87	Tactile Warning - Abrasive coating on both levers	\$98.00
AV	Anti Vandal Pull Trim (available in 32D finish), (Not available with 8270, 8271, 8272, 8273 functions)	\$229.00
BR	SARGENT Bump Resistant Cylinders (N/A w/10, 22, 30, 60, 63, 64, 70, 72, 73, 737P, KESO, SC, & SE options)	\$25.00 /cyl.
DG1	Patented Degree DG1 Key System	No addition
DG160	Hardware prepared for DG1-6300 Lg. Format IC cores, supplied with temporary plastic construction cores	No addition
DG163	Patented Degree DG1 Large Format Interchangeable Core Cylinder - Includes master keying charges	\$83.00
DG164	Hardware prepared for DG1-6300 Lg. Format IC cores, supplied with temporary keyed construction cores	\$83.00
DG2	Patented Degree DG2 Key System incorporating a locking sidebar	\$63.00/cyl.
DG260	Hardware prepared for DG2-6300 Lg. Format IC cores, supplied with temporary plastic construction cores	No addition
DG263	Patented Degree DG2 Large Format Interchangeable Core Cylinder - Includes master keying charges	\$146.00
DG264	Hardware prepared for DG2-6300 Lg. Format IC cores, supplied with temporary keyed construction cores	\$83.00
DG3	Patented Degree DG3 Key System incorporating a locking sidebar and UL437 listed	\$89.00/cyl.
DG360	Hardware prepared for DG3-6300 Lg. Format IC cores, supplied with temporary plastic construction cores	No addition
DG363	Patented Degree DG3 Large Format Interchangeable Core Cylinder - Includes master keying charges	\$172.00
DG364	Hardware prepared for DG3-6300 Lg. Format IC cores, supplied with temporary keyed construction cores	\$83.00
IDP	Integrated door position switch	\$108.00
LC	Less Cylinder	-\$96.00/cyl.
LB	Extra large thumbturn	\$18.00
OBS	Open Back Strike	\$79.00
PHR	Deadbolt Privacy Function (available w/deadbolt function only)	\$100.00
R01	Mercury and Lenel compatible 1KΩ/2KΩ resistance supervision	\$100.00
R03	Software House compatible 1KΩ/2KΩ resistance supervision	\$100.00
R04	AMAG compatible 4-state supervision	\$100.00
SC▲†	Schlage "C" Keyway cylinder, (Number 41 Cylinder Only, 0 bitted)	No addition
SE▲†	Schlage "E" Keyway cylinder, (Number 41 Cylinder Only, 0 bitted)	No addition
SG	MicroShield® - an antimicrobial powder coat finish	\$73.00
T1	Decorative thumbturn; backplate matches rose design chosen	No Addition
T2	Decorative square thumbturn; backplate matches rose design chosen	No Addition
T3	Decorative cylinder thumbturn; backplate matches rose design chosen	No Addition
WBS	Wrought Box Strike	No addition

NOTES: ▲ Options not avail. with a standard 50 function lockout cylinder. † Not avail. with 60, 63, 64 options

CPC	Clear Powder Coat over 26D/32D - 8205 x CRH001 x RH x 32D x CPC All orders will continue to be handled as a "special" when CPC is ordered.	\$67.00
-----	---	---------

Experience a safer
and more open world

Copyright © 2002-2021 Sargent Manufacturing Company, an ASSA ABLOY Group company. All rights reserved.
Reproduction in whole or in part without the express written permission of Sargent Manufacturing Company is prohibited.
Contact us at: 800-727-5477 or visit www.sargentlock.com. In Canada contact us at: 800-461-3007 or visit www.assaabloydss.ca

ASSA ABLOY

8200 STUDIO COLLECTION WOOSTER SQUARE

Rose Design:

- CO (2-3/4")
- CR (2-3/16")
- LN (2")
- O (2-3/4")
- TO (2-3/4")
- TR (2-3/16")
- E2 (2-11/16")
- E3 (2-1/16")
- E4 (3-1/4")

Lever Design:

- H003, H004, H005, H006, H007,
- *H008, H009, H010, H011



How to order:

- 21-8205 x E4H003 x RH x 10BE**
- Option 21
- Function 8205
- Rose E4
- Lever H003
- Hand RH
- Finish 10BE

* Handed - specify hand when ordering.

USA & Canada Prices Effective May 1, 2021

NAC 8200 Electrified Mortise Locks with High Security Monitoring				10BE/26D/ BSP/WSP	03/04/09/10/ 10B/10BL/14/15/ 20D/26
Option	Function	Trim - Proximity Entry	Description		
NAC	82270-12V/-24V	Rose x Lever Design	Fail Safe w/Cylinder Override	\$1,645.00	\$1,669.00
NAC	82271-12V/-24V	Rose x Lever Design	Fail Secure w/Cylinder Override		
NAC	82280-12V/-24V	Rose x Lever Design	Fail Safe w/Deadbolt w/Cyl.Override	\$1,720.00	\$1,744.00
NAC	82281-12V/-24V	Rose x Lever Design	Fail Secure w/D.bolt w/Cyl.Override		
NAC	82274-12V/-24V	Rose x Lever Design	Fail Safe - No Cylinder	\$1,590.00	\$1,614.00
NAC	82275-12V/-24V	Rose x Lever Design	Fail Secure - No Cylinder		
NAC	82284-12V/-24V	Rose x Lever Design	Fail Safe w/Deadbolt - No Cylinder	\$1,665.00	\$1,689.00
NAC	82285-12V/-24V	Rose x Lever Design	Fail Secure w/Deadbolt - No Cylinder		

Note: Consult catalog for ordering information.

Specify hand and voltage (12v or 24v) when ordering

ML-48 MORTISE LOCKS

For V Series
Indicators
Click / See
Page ML-1A

SARGENT®

ASSA ABLOY

OPTIONS

USA & Canada Prices Effective May 1, 2021

Options	Description	Price
1▲	8200 Line with 1-1/16" wide front for 1-3/8" doors.	\$62.00
3	Stainless steel hub (not available with 8289, 8291 & 8292 functions)	\$69.00
10▲	SARGENT Signature Key System	\$63.00 / cyl.
11†▲	SARGENT XC Key System (not available with 10, 22, SC, SE options)	No addition
1160	SARGENT XC Large Format Interchangeable Plastic Disposable Construction Core	No addition
1163	SARGENT XC Large Format Interchangeable Core Cylinder - Includes masterkeying charges	\$83.00
1164	SARGENT XC Large Format Interchangeable Construction Core Cylinder	\$83.00
1170	Small Format interchangeable disposable construction core - to accept 7 Pin XC permanent core	No addition
11727P	Small Format interchangeable keyed construction core - to accept 7 Pin XC permanent core	\$75.00
11737P	Small Format interchangeable core - to accept 7 pin XC permanent core	\$75.00 / cyl.
21▲†	SARGENT Construction Key System (lost ball) Standard on all new systems established since 5/1/96	\$16.00 / cyl.
22▲†	SARGENT Construction Key System (split key) To be used on pre-established split key systems only	\$32.00 / cyl.
23	Locksets with flat 4 7/8" ANSI strike	No addition
31	Thick Doors - Extended Lip Required - Specify Length C to E - Cylinders - IMPORTANT- See catalog 7800/8200 option page for cylinder limitations - Below charges DO NOT include additional charges for special cylinder requirements	
	Doors up to 2-1/2" thick - lock centered	No addition
	Doors 2-5/8" to 6" thick OR doors 1-3/4" thick w/max 1" paneling one side. For example: Specify 1-3/4" door with panel (Side) on inside or outside	Non Keyed function \$50.00 Keyed function \$100.00
49	Visual Status Indicator - Available with 30, 36, 37 function - Rose Trims CR, E, L, LN, O, TR - Available with 26, 29, 38, 39 40, 41 functions - Rose Trim 8200 LN	\$140.00
49	Occupancy Indicator with emergency Release - Available with 65, 66, 68 functions; Rose Trims 7800 CR, E, L, LN, O, TR	\$140.00
50	Secured Indicator Rose- doors 1-5/8" to 2-1/4" thick- Avail.w/24,25,26,28,29,30,36,37,38,39,40,41,43,45,50,51,52,57,58,67 functions	\$140.00
60	SARGENT Large Format Interchangeable Plastic Disposable Construction Core	No addition
63	SARGENT Large Format Interchangeable core cylinder, includes master keying charges	\$83.00 / cyl.
64	SARGENT Large Format Interchangeable Construction Core Cylinder	\$83.00
6573▲†	Small Format 6-Pin Uncombined Core (Refer to CK-12)	\$65.00 / cyl.
65737P▲†	Small Format 7-Pin Uncombined Core (Refer to CK-12)	\$65.00 / cyl.
68	8200 Line furnished with lever handle outside x knob inside (Excludes SLD Detention Knob)	Defaults to 8200 Lever Lock Price
69	8200 Line furnished with lever handle inside x knob outside (Excludes SLD Detention Knob)	Defaults to 8200 Lever Lock Price
70▲†	Small Format Interchangeable disposable plastic construction core	No addition
72▲†	Small Format Interchangeable 6-pin construction core (7-pin with 11 option)	See CK-2
73▲†	Small Format 6-pin interchangeable core (refer to CK-8 for available keyways)	\$75.00 / cyl
737P▲†	Small Format Interchangeable core (refer to CK 8 for available keyways)	\$75.00 / cyl
74	Lock case wrapped in lead - handing required (roses not available)	\$294.00
81▲†	Cylinder to accept Keso (83) and Keso F1 (F183) removable core - no core provided	No addition
F182†	SARGENT Keso Security Cylinder - patented - new key systems	\$91.00 / cyl.
F183▲†	SARGENT Keso Security Removable Core Cylinder - patented - new key systems	\$130.00 / cyl.
82†	SARGENT Keso Security Cylinder (For existing systems only)	\$91.00 / cyl.
83▲†	SARGENT Keso Security Removable Core Cylinder (For existing systems only)	\$130.00 / cyl.
84▲†	SARGENT Keso Security Removable Construction Core Cylinder	See CK-18
85	Tactile Warning - Abrasive coating on inside lever	\$49.00
86	Tactile Warning - Abrasive coating on outside lever	\$49.00
87	Tactile Warning - Abrasive coating on both levers	\$98.00
AV	Anti Vandal Pull Trim (available in 32D finish), (Not available with 8270, 8271, 8272, 8273 functions)	\$229.00
BR	SARGENT Bump Resistant Cylinders (N/A w/10, 22, 30, 60, 63, 64, 70, 72, 73, 737P, KESO, SC, & SE options)	\$25.00 /cyl.
DG1	Patented Degree DG1 Key System	No addition
DG160	Hardware prepared for DG1-6300 Lg. Format IC cores, supplied with temporary plastic construction cores	No addition
DG163	Patented Degree DG1 Large Format Interchangeable Core Cylinder - Includes master keying charges	\$83.00
DG164	Hardware prepared for DG1-6300 Lg. Format IC cores, supplied with temporary keyed construction cores	\$83.00
DG2	Patented Degree DG2 Key System incorporating a locking sidebar	\$63.00/cyl.
DG260	Hardware prepared for DG2-6300 Lg. Format IC cores, supplied with temporary plastic construction cores	No addition
DG263	Patented Degree DG2 Large Format Interchangeable Core Cylinder - Includes master keying charges	\$146.00
DG264	Hardware prepared for DG2-6300 Lg. Format IC cores, supplied with temporary keyed construction cores	\$83.00
DG3	Patented Degree DG3 Key System incorporating a locking sidebar and UL437 listed	\$89.00/cyl.
DG360	Hardware prepared for DG3-6300 Lg. Format IC cores, supplied with temporary plastic construction cores	No addition
DG363	Patented Degree DG3 Large Format Interchangeable Core Cylinder - Includes master keying charges	\$172.00
DG364	Hardware prepared for DG3-6300 Lg. Format IC cores, supplied with temporary keyed construction cores	\$83.00
DX	Deadbolt Monitoring (not available with 50, 74)	\$197.00
LC	Less Cylinder	-\$96.00/cyl.
LB	Extra large thumbturn	\$18.00
LX	Latchbolt Monitor - available with all non-deadbolt functions; not available with DX option	\$200.00
OBS	Open Back Strike	\$79.00
RX	Request to Exit	\$206.00
SC▲†	Schlage "C" Keyway cylinder, (Number 41 Cylinder Only, 0 bitted)	No addition
SE▲†	Schlage "E" Keyway cylinder, (Number 41 Cylinder Only, 0 bitted)	No addition
SG	MicroShield® - an antimicrobial powder coat finish	\$73.00
T1	Decorative thumbturn; backplate matches rose design chosen	No Addition
T2	Decorative square thumbturn; backplate matches rose design chosen	No Addition
T3	Decorative cylinder thumbturn; backplate matches rose design chosen	No Addition
WBS	Wrought Box Strike	No addition

NOTES: ▲ Options not avail. with a standard 50 function lockout cylinder. † Not avail. with 60, 63, 64 options

CPC Clear Powder Coat over 26D/32D - 8205 x CRMD x RH x 32D x CPC \$67.00
All orders will continue to be handled as a "special" when CPC is ordered.

Experience a safer
and more open world

Copyright © 2002-2021 Sargent Manufacturing Company, an ASSA ABLOY Group company. All rights reserved.
Reproduction in whole or in part without the express written permission of Sargent Manufacturing Company is prohibited.
Contact us at: 800-727-5477 or visit www.sargentlock.com. In Canada contact us at: 800-461-3007 or visit www.assaabloydss.ca

ASSA ABLOY

8200 STUDIO COLLECTION

USA & Canada Prices Effective May 1, 2021

Rose Design:

CO (2-3/4")
CR (2-3/16")
LN (2")
O (2-3/4")
TO (2-3/4")
TR (2-3/16")
E2 (2-11/16")
E3 (2-1/16")
E4 (3-1/4")

Studio Lever Series Designs:

Studio Collection Levers Except for Gramercy, Wooster Square, & Grant Park
* Following levers not available in 32 & 32D: MA, MC, MH, MK, MM, MN, MO, MP, MQ, MS, MT, MU, MV, MX, MY, MZ, NS, NU

How to order:

21-8205 x CRMD x RH x 26D
Option 21
Function 8205
Rose CR
Lever MD
Hand RH
Finish 26D

Function		Finish	
		10BE/26D/BSP/WSP	03/04/09/10/10B/10BL/14/15/20D/26/*32/*32D
Single Cyl			
8204	Storeroom or Closet		
8205	Office or Entry	\$1,094.00	\$1,118.00
8237	Classroom		
8255	Office or Entry		
<hr/>			
8206	Storeroom or Service		
8231	Utility		
8236	Closet		
8256	Office or Inner Entry	\$1,121.00	\$1,145.00
8257, 8258, 8267	Institutional Privacy		
8289	Holdback		
8291	All Purpose Holdback		
<hr/>			
Single Cyl With Deadbolt			
8224	Room Door		
8225	Dormitory or Exit		
8227	Closet or Storeroom		
8228, 8230	Dummy Trim Deadlock	\$1,153.00	\$1,177.00
8235	Storeroom		
8243	Apartment Corridor		
8245	Dormitory or Exit		
8247	Front Door or Apartment Corridor		
8251	Storeroom Deadbolt		
8250	Hotel Guest Lock	\$1,188.00	\$1,212.00
<hr/>			
Double Cyl No Deadbolt			
8216	Apartment or Exit or Public Toilet		
8217	Asylum or Institutional		
8238	Classroom Security Intruder		
8242	Classroom Security Intruder Latchbolt		
8259	School Security		
8290	Classroom Security Holdback	\$1,205.00	\$1,229.00
8292	All Purpose Holdback		
<hr/>			
Double Cyl With Deadbolt			
8226	Store Door		
8229	Dummy Trim Deadlock		
8239, 8240	Classroom Security Intruder		
8241	Classroom Security		
8246	Dormitory or Exit		
8248	Store Door	\$1,228.00	\$1,252.00
8249	Security Deadbolt		
8252	Institutional		
<hr/>			
Electro Mechanical Single Cyl – Specify 12V or 24V			
8270-12V / 8270-24V	Fail Safe	\$1,290.00	\$1,314.00
8271-12V / 8271-24V	Fail Secure		
<hr/>			
Electro Mechanical Double Cyl – Specify 12V or 24V			
8272-12V / 8272-24V	Fail Safe	\$1,347.00	\$1,371.00
8273-12V / 8273-24V	Fail Secure		
<hr/>			
Non Keyed			
8213	Communication or Exit	\$877.00	\$901.00
8215	Passage or Closet		
8265	Privacy Bedroom or Bath (Latch)	\$965.00	\$989.00
8266, 8268	Privacy Bedroom or Bath (Deadbolt)	\$1,069.00	\$1,093.00
8293*	Single Dummy Trim	\$362.00	\$374.00
8294	Double Dummy Trim	\$723.00	\$747.00
8295	Single Dummy Trim w/Lockbody	\$464.00	\$476.00
8296	Double Dummy Trim w/Lockbody	\$830.00	\$854.00
8297	Double Dummy w/Active Trim	\$920.00	\$944.00

Experience a safer
and more open world

ML-50 MORTISE LOCKS

For V Series
Indicators
Click / See
Page ML-1A

SARGENT®

ASSA ABLOY

OPTION

USA & Canada Prices Effective May 1, 2021

Options	Description	Price
1▲	8200 Line with 1-1/16" wide front for 1-3/8" doors.	\$62.00
3	Stainless steel hub (not available with 8289, 8291 & 8292 functions)	\$69.00
10▲	SARGENT Signature Key System	\$63.00 / cyl.
11†▲	SARGENT XC Key System (not available w/10, KESO, SC, SE)	No addition
1160	SARGENT XC Large Format Interchangeable Plastic Disposable Construction Core	No addition
1163	SARGENT XC Large Format Interchangeable Core Cylinder - Includes masterkeying charges	\$83.00
1164	SARGENT XC Large Format Interchangeable Construction Core Cylinder	\$83.00
1170	Small Format interchangeable disposable construction core - to accept 7 Pin XC permanent core	No addition
11727P	Small Format interchangeable keyed construction core - to accept 7 Pin XC permanent core	\$75.00
11737P	Small Format interchangeable core - to accept 7 pin XC permanent core	\$75.00 / cyl.
21▲†	SARGENT Construction Key System (lost ball) Standard on all new systems established since 5/1/96	\$16.00 / cyl.
22▲†	SARGENT Construction Key System (split key) To be used on pre-established split key systems only	\$32.00 / cyl.
23	Locksets with flat 4 7/8" ANSI strike	No addition
31	Thick Doors - Extended Lip Required - Specify Length C to E IMPORTANT: See 7800/8200 Catalog Option Page for Cylinder Limits – DOES NOT include additional Charges for Special Cylinder Requirements	No addition
	Doors up to 2-1/2" thick - lock centered • Doors 2-5/8" to 6" thick OR doors 1-3/4" thick w/max 1" paneling one side. For example: Specify 1-3/4" door with panel (Side) on inside or outside	Non Keyed function \$50.00 Keyed function \$100.00
36	6 Lobe security head screws	\$24.00
37	Spanner head screws	\$17.00
49	Visual Status Indicator – Available with 30, 36, 37 function – Rose Trims CR, E, L, LN, O, TR – Available with 26, 29, 38, 39 40, 41 functions – Rose Trim 8200 LN	\$140.00
49	Occupancy Indicator with emergency Release – Available with 65, 66, 68 functions; Rose Trims 7800 CR, E, L, LN, O, TR	\$140.00
50	Secured Indicator Rose– doors 1-5/8" to 2-1/4" thick– Avail.w/24,25,26,28,29,30,36,37,38,39,40,41,43,45,50,51,52,57,58,67 functions	\$140.00
60	SARGENT Large Format Interchangeable Plastic Disposable Construction Core	No addition
63	SARGENT Large Format Interchangeable core cylinder, includes master keying charges	\$83.00 / cyl
64	SARGENT Large Format Interchangeable Construction Core Cylinder	\$83.00
6573▲†	Small Format 6-Pin Uncombined Core (Refer to CK-12)	\$65.00 / cyl.
65737P▲†	Small Format 7-Pin Uncombined Core (Refer to CK-12)	\$65.00 / cyl.
68	8200 Line furnished with lever handle outside x knob inside (Excludes SLD Detention Knob)	Defaults to 8200 Lever Lock Price
69	8200 Line furnished with lever handle inside x knob outside (Excludes SLD Detention Knob)	Defaults to 8200 Lever Lock Price
70▲†	Small Format interchangeable disposable plastic construction core	No addition
72▲†	Small Format interchangeable 6-Pin construction core	\$75.00
73▲†	Small Format interchangeable core 6-pin Includes MK and GMK keying charges	\$75.00 / cyl
737P▲†	Small Format interchangeable core 7-pin (refer to CK-12 for available keyways) Includes MK and GMK keying charges	\$75.00 / cyl
74	Lock case wrapped in lead – handing required (roses not available)	\$262.00
81▲†	Cylinder to accept Keso (83) and Keso F1 (F183) removable core – no core provided	No addition
F182†	SARGENT Keso Security Cylinder – patented – new key systems	\$91.00 / cyl.
F183▲†	SARGENT Keso Security Removable Core Cylinder – patented – new key systems	\$130.00 / cyl.
82†	SARGENT Keso Security Cylinder (For existing systems only)	\$91.00 / cyl.
83▲†	SARGENT Keso Security Removable Core Cylinder (For existing systems only)	\$130.00 / cyl.
84▲†	SARGENT Keso Security Removable Construction Core Cylinder	See CK-18
85	Tactile Warning - Abrasive Coating on Inside Lever	\$49.00
86	Tactile Warning - Abrasive Coating on Outside Lever	\$49.00
87	Tactile Warning - Abrasive Coating on Outside & Inside Lever	\$98.00
AV	Anti Vandal Pull Trim (available in 32D finish), (Not available with 8270, 8271, 8272, 8273 functions)	\$229.00
BR	SARGENT Bump Resistant Cylinders (N/A w/10, 22, 30, 60, 63, 64, 70, 72, 73, 737P, KESO, SC, & SE options)	\$25.00 / cyl.
DG1	Patented Degree DG1 Key System	No addition
DG160	Hardware prepared for DG1-6300 Lg. Format IC cores, supplied with temporary plastic construction cores	No addition
DG163	Patented Degree DG1 Large Format Interchangeable Core Cylinder - Includes master keying charges	\$83.00
DG164	Hardware prepared for DG1-6300 Lg. Format IC cores, supplied with temporary keyed construction cores	\$83.00
DG2	Patented Degree DG2 Key System incorporating a locking sidebar	\$63.00/cyl.
DG260	Hardware prepared for DG2-6300 Lg. Format IC cores, supplied with temporary plastic construction cores	No addition
DG263	Patented Degree DG2 Large Format Interchangeable Core Cylinder - Includes master keying charges	\$146.00
DG264	Hardware prepared for DG2-6300 Lg. Format IC cores, supplied with temporary keyed construction cores	\$83.00
DG3	Patented Degree DG3 Key System incorporating a locking sidebar and UL437 listed	\$89.00/cyl.
DG360	Hardware prepared for DG3-6300 Lg. Format IC cores, supplied with temporary plastic construction cores	No addition
DG363	Patented Degree DG3 Large Format Interchangeable Core Cylinder - Includes master keying charges	\$172.00
DG364	Hardware prepared for DG3-6300 Lg. Format IC cores, supplied with temporary keyed construction cores	\$83.00
IDP	Integrated Door Position Switch	\$108.00
LB	Extra large thumbturn	\$18.00
LC	Less Cylinder	-\$96.00/cyl.
OBS	Open Back Strike	\$79.00
PHR	Deadbolt Privacy Function (available w/deadbolt function only)	\$100.00
R01	Mercury and Lenel compatible 1KΩ/2KΩ resistance supervision	\$100.00
R03	Software House compatible 1KΩ/2KΩ resistance supervision	\$100.00
R04	AMAG compatible 4-state supervision	\$100.00
SC▲†	Schlage "C" Keyway cylinder, (Number 41 Cylinder Only, 0 bitted)	No addition
SE▲†	Schlage "E" Keyway cylinder, (Number 41 Cylinder Only, 0 bitted)	No addition
SG	MicroShield® – an antimicrobial powder coat finish	\$73.00
WBS	Wrought Box Strike	No addition

NOTES: ▲ Options not avail. with a standard 50 function lockout cylinder. † Not avail. with 60, 63, 64 options
CPC Clear Powder Coat over 26D/32D – 8205 x LNA x RH x 32D x CPC \$67.00
All orders will continue to be handled as a "special" when CPC is ordered.

Experience a safer
and more open world

Copyright © 2002-2021 Sargent Manufacturing Company, an ASSA ABLOY Group company. All rights reserved.
Reproduction in whole or in part without the express written permission of Sargent Manufacturing Company is prohibited.
Contact us at: 800-727-5477 or visit www.sargentlock.com. In Canada contact us at: 800-461-3007 or visit www.assaabloydss.ca

USA & Canada Prices Effective May 1, 2021

Rose Design:

CO (2-3/4")
CR (2-3/16")
LN (2")
O (2-3/4")
TO (2-3/4")
TR (2-3/16")
E2 (2-11/16")
E3 (2-1/16")
E4 (3-1/4")

Studio Lever Series Designs:

All Studio Collection Levers Except for Gramercy, Wooster Square, & Grant Park
* Following levers not available in 32 & 32D: MA, MC, MH, MK, MM, MN, MO, MP, MQ, MS, MT, MU, MV, MX, MY, MZ, NS, NU

How to order:

NAC 82270-12V x CRMD x RH x 26D
Option 21
Function 8205
Rose CR
Lever MD
Hand RH
Finish 26D

NAC 8200 Electrified Mortise Locks with High Security Monitoring				10BE/26D/ BSP/WSP	03/04/09/10/ 10B/10BL/14/15/ 20D/26/*32/*32D
Option	Function	Trim - Proximity Entry	Description		
NAC	82270-12V/-24V	Rose x Lever Design	Fail Safe w/Cylinder Override	\$1,465.00	\$1,489.00
NAC	82271-12V/-24V	Rose x Lever Design	Fail Secure w/Cylinder Override		
NAC	82280-12V/-24V	Rose x Lever Design	Fail Safe w/Deadbolt w/Cyl.Override	\$1,540.00	\$1,564.00
NAC	82281-12V/-24V	Rose x Lever Design	Fail Secure w/D.bolt w/Cyl.Override		
NAC	82274-12V/-24V	Rose x Lever Design	Fail Safe - No Cylinder	\$1,410.00	\$1,434.00
NAC	82275-12V/-24V	Rose x Lever Design	Fail Secure - No Cylinder		
NAC	82284-12V/-24V	Rose x Lever Design	Fail Safe w/Deadbolt - No Cylinder	\$1,485.00	\$1,509.00
NAC	82285-12V/-24V	Rose x Lever Design	Fail Secure w/Deadbolt - No Cylinder		

Note: Consult catalog for ordering information.

Specify hand and voltage (12v or 24v) when ordering

ML-52 MORTISE LOCKS

SARGENT®

ASSA ABLOY

OPTIONS

USA & Canada Prices Effective May 1, 2021

Options	Description	Price
1▲	8200 Line with 1-1/16" wide front for 1-3/8" doors.	\$62.00
3	Stainless steel hub (not available with 8289, 8291 & 8292 functions)	\$69.00
10▲	SARGENT Signature Key System	\$63.00 / cyl.
11†▲	SARGENT XC Key System (not available with 10, 22, SC, SE options)	No addition
1160	SARGENT XC Large Format Interchangeable Plastic Disposable Construction Core	No addition
1163	SARGENT XC Large Format Interchangeable Core Cylinder - Includes masterkeying charges	\$83.00
1164	SARGENT XC Large Format Interchangeable Construction Core Cylinder	\$83.00
1170	Small Format interchangeable disposable construction core - to accept 7 Pin XC permanent core	No addition
11727P	Small Format interchangeable keyed construction core - to accept 7 Pin XC permanent core	\$75.00
11737P	Small Format interchangeable core - to accept 7 pin XC permanent core	\$75.00 /cyl.
21▲†	SARGENT Construction Key System (lost ball) Standard on all new systems established since 5/1/96	\$16.00 / cyl.
22▲†	SARGENT Construction Key System (split key) To be used on pre-established split key systems only	\$32.00 / cyl.
23	Locksets with flat 4 7/8" ANSI strike	No addition
31	Thick Doors - Extended Lip Required - Specify Length C to E - Cylinders - IMPORTANT- See catalog 7800/8200 option page for cylinder limitations - Below charges DO NOT include additional charges for special cylinder requirements	No addition
	Doors up to 2-1/2" thick - lock centered	No addition
	Doors 2-5/8" to 6" thick OR doors 1-3/4" thick w/max 1" paneling one side. For example: Specify 1-3/4" door with panel (Side) on inside or outside	Non Keyed function \$50.00 Keyed function \$100.00
60	SARGENT Large Format Interchangeable Plastic Disposable Construction Core	No addition
63	SARGENT Large Format Interchangeable core cylinder, includes master keying charges	\$83.00 / cyl.
64	SARGENT Large Format Interchangeable Construction Core Cylinder	\$83.00
6573▲†	Small Format 6-Pin Uncombined Core (Refer to CK-12)	\$65.00 / cyl.
65737P▲†	Small Format 7-Pin Uncombined Core (Refer to CK-12)	\$65.00 / cyl.
68	8200 Line furnished with lever handle outside x knob inside (Excludes SLD Detention Knob)	Defaults to 8200 Lever Lock Price
69	8200 Line furnished with lever handle inside x knob outside (Excludes SLD Detention Knob)	Defaults to 8200 Lever Lock Price
70▲†	Small Format Interchangeable disposable plastic construction core	No addition
72▲†	Small Format Interchangeable 6-pin construction core (7-pin with 11 option)	\$75.00
73▲†	Small Format interchangeable core 6-pin Includes MK and GMK keying charges	\$75.00 / cyl
737P▲†	Small Format interchangeable core 7-pin (refer to CK-12 for available keyways) Includes MK and GMK keying charges	\$75.00 / cyl
81▲†	Cylinder to accept Keso (83) and Keso F1 (F183) removable core – no core provided	No addition
F182†	SARGENT Keso Security Cylinder – patented – new key systems	\$91.00 / cyl.
F183▲†	SARGENT Keso Security Removable Core Cylinder – patented – new key systems	\$130.00 / cyl.
82†	SARGENT Keso Security Cylinder (For existing systems only)	\$91.00 / cyl.
83▲†	SARGENT Keso Security Removable Core Cylinder (For existing systems only)	\$130.00 / cyl.
84▲†	SARGENT Keso Security Removable Construction Core Cylinder	See CK-18
85	Tactile Warning - Abrasive coating on inside lever	\$49.00
86	Tactile Warning - Abrasive coating on outside lever	\$49.00
87	Tactile Warning - Abrasive coating on both levers	\$98.00
AV	Anti Vandal Pull Trim (available in 32D finish), (Not available with 8270, 8271, 8272, 8273 functions)	\$229.00
BR	SARGENT Bump Resistant Cylinders (N/A w/10, 22, 30, 60, 63, 64, 70, 72, 73, 737P, KESO, SC, & SE options)	\$25.00 /cyl.
DG1	Patented Degree DG1 Key System	No addition
DG160	Hardware prepared for DG1-6300 Lg. Format IC cores, supplied with temporary plastic construction cores	No addition
DG163	Patented Degree DG1 Large Format Interchangeable Core Cylinder - Includes master keying charges	\$83.00
DG164	Hardware prepared for DG1-6300 Lg. Format IC cores, supplied with temporary keyed construction cores	\$83.00
DG2	Patented Degree DG2 Key System incorporating a locking sidebar	\$63.00/cyl.
DG260	Hardware prepared for DG2-6300 Lg. Format IC cores, supplied with temporary plastic construction cores	No addition
DG263	Patented Degree DG2 Large Format Interchangeable Core Cylinder - Includes master keying charges	\$146.00
DG264	Hardware prepared for DG2-6300 Lg. Format IC cores, supplied with temporary keyed construction cores	\$83.00
DG3	Patented Degree DG3 Key System incorporating a locking sidebar and UL437 listed	\$89.00/cyl.
DG360	Hardware prepared for DG3-6300 Lg. Format IC cores, supplied with temporary plastic construction cores	No addition
DG363	Patented Degree DG3 Large Format Interchangeable Core Cylinder - Includes master keying charges	\$172.00
DG364	Hardware prepared for DG3-6300 Lg. Format IC cores, supplied with temporary keyed construction cores	\$83.00
DX	Deadbolt Monitoring (not available with 50, 74)	\$197.00
LB	Extra large thumbturn	\$18.00
LC	Less Cylinder	-\$96.00/cyl.
LX	Latchbolt Monitor – available with all non-deadbolt functions; not available with DX option	\$200.00
OBS	Open Back Strike	\$79.00
RX	Request to Exit	\$206.00
SC▲†	Schlage "C" Keyway cylinder, (Number 41 Cylinder Only, 0 bitted)	No addition
SE▲†	Schlage "E" Keyway cylinder, (Number 41 Cylinder Only, 0 bitted)	No addition
SG	MicroShield® – an antimicrobial powder coat finish	\$73.00
WBS	Wrought Box Strike	No addition
NOTES: ▲ Options not avail. with a standard 50 function lockout cylinder. † Not avail. with 60, 63, 64 options		
CPC	Clear Powder Coat over 26D/32D – 8205 x CEH001 x RH x 32D x CPC All orders will continue to be handled as a "special" when CPC is ordered.	\$67.00

Experience a safer
and more open world

Copyright © 2002-2021 Sargent Manufacturing Company, an ASSA ABLOY Group company. All rights reserved.
Reproduction in whole or in part without the express written permission of Sargent Manufacturing Company is prohibited.
Contact us at: 800-727-5477 or visit www.sargentlock.com. In Canada contact us at: 800-461-3007 or visit www.assaabloydss.ca

ASSA ABLOY

8200 STUDIO COLLECTION WOOSTER SQUARE

Escutcheon Designs:
CE
TE
LE1

Lever Design:
H001, H002



H001



H002

How to order:
21-8205 x CEH001x RH x 10BE
Option 21
Function 8205
Rose CE
Lever H001
Hand RH
Finish 10BE

USA & Canada Prices Effective May 1, 2021

Function		Finish	
		10BE/26D/BSP/WSP	03/04/09/10/10B/10BL/14/15/20D/26/32/32D
Single Cyl			
8204	Storeroom or Closet		
8205	Office or Entry	\$1,290.00	\$1,314.00
8237	Classroom		
8255	Office or Entry		
8206	Storeroom or Service		
8231	Utility		
8236	Closet		
8256	Office or Inner Entry	\$1,314.00	\$1,338.00
8257, 8258, 8267	Institutional Privacy		
8289	Holdback		
8291	All Purpose Holdback		
Single Cyl With Deadbolt			
8224	Room Door		
8225	Dormitory or Exit		
8227	Closet or Storeroom		
8228, 8230	Dummy Trim Deadlock		
8235	Storeroom	\$1,344.00	\$1,368.00
8243	Apartment Corridor		
8245	Dormitory or Exit		
8247	Front Door or Apartment Corridor		
8251	Storeroom Deadbolt		
8250	Hotel Guest Lock	\$1,377.00	\$1,401.00
Double Cyl No Deadbolt			
8216	Apartment or Exit or Public Toilet		
8217	Asylum or Institutional		
8238	Classroom Security Intruder		
8242	Classroom Security Intruder Latchbolt	\$1,397.00	\$1,421.00
8259	School Security		
8290	Classroom Security Holdback		
8292	All Purpose Holdback		
Double Cyl With Deadbolt			
8226	Store Door		
8229	Dummy Trim Deadlock		
8239, 8240	Classroom Security Intruder		
8241	Classroom Security		
8246	Dormitory or Exit	\$1,420.00	\$1,444.00
8248	Store Door		
8249	Security Deadbolt		
8252	Institutional		
Electro Mechanical Single Cyl – Specify 12V or 24V			
8270-12V / 8270-24V	Fail Safe	\$1,486.00	\$1,510.00
8271-12V / 8271-24V	Fail Secure		
Electro Mechanical Double Cyl – Specify 12V or 24V			
8272-12V / 8272-24V	Fail Safe	\$1,543.00	\$1,567.00
8273-12V / 8273-24V	Fail Secure		
Non Keyed			
8213	Communication or Exit	\$1,126.00	\$1,150.00
8215	Passage or Closet		
8265	Privacy Bedroom or Bath (Latch)	\$1,232.00	\$1,256.00
8266, 8268	Privacy Bedroom or Bath (Deadbolt)	\$1,268.00	\$1,292.00
8293*	Single Dummy Trim	\$458.00	\$482.00
8294	Double Dummy Trim	\$941.00	\$965.00
8295	Single Dummy Trim w/Lockbody	\$555.00	\$579.00
8296	Double Dummy Trim w/Lockbody	\$1,042.00	\$1,066.00
8297	Double Dummy w/Active Trim	\$1,126.00	\$1,150.00

Experience a safer
and more open world

ML-54 MORTISE LOCKS

SARGENT®

ASSA ABLOY

OPTIONS

USA & Canada Prices Effective May 1, 2021

Options	Description	Price
1▲	8200 Line with 1-1/16" wide front for 1-3/8" doors.	\$62.00
3	Stainless steel hub (not available with 8289, 8291 & 8292 functions)	\$69.00
10▲	SARGENT Signature Key System	\$63.00 / cyl.
11†▲	SARGENT XC Key System (not available with 10, 22, SC, SE options)	No addition
1160	SARGENT XC Large Format Interchangeable Plastic Disposable Construction Core	No addition
1163	SARGENT XC Large Format Interchangeable Core Cylinder - Includes masterkeying charges	\$83.00
1164	SARGENT XC Large Format Interchangeable Construction Core Cylinder	\$83.00
1170	Small Format interchangeable disposable construction core - to accept 7 Pin XC permanent core	No addition
11727P	Small Format interchangeable keyed construction core - to accept 7 Pin XC permanent core	\$75.00
11737P	Small Format interchangeable core - to accept 7 pin XC permanent core	\$75.00 /cyl.
21▲†	SARGENT Construction Key System (lost ball) Standard on all new systems established since 5/1/96	\$16.00 / cyl.
22▲†	SARGENT Construction Key System (split key) To be used on pre-established split key systems only	\$32.00 / cyl.
23	Locksets with flat 4 7/8" ANSI strike	No addition
31	Thick Doors - Extended Lip Required - Specify Length C to E - Cylinders - IMPORTANT- See catalog 7800/8200 option page for cylinder limitations - Below charges DO NOT include additional charges for special cylinder requirements	No addition
	Doors up to 2-1/2" thick - lock centered	No addition
	Doors 2-5/8" to 6" thick OR doors 1-3/4" thick w/max 1" paneling one side. For example: Specify 1-3/4" door with panel (Side) on inside or outside	Non Keyed function \$50.00 Keyed function \$100.00
60	SARGENT Large Format Interchangeable Plastic Disposable Construction Core	No addition
63	SARGENT Large Format Interchangeable core cylinder, includes master keying charges	\$83.00 / cyl.
64	SARGENT Large Format Interchangeable Construction Core Cylinder	\$83.00
6573▲†	Small Format 6-Pin Uncombined Core (Refer to CK-12)	\$65.00 / cyl.
65737P▲†	Small Format 7-Pin Uncombined Core (Refer to CK-12)	\$65.00 / cyl.
68	8200 Line furnished with lever handle outside x knob inside (Excludes SLD Detention Knob)	Defaults to 8200 Lever Lock Price
69	8200 Line furnished with lever handle inside x knob outside (Excludes SLD Detention Knob)	Defaults to 8200 Lever Lock Price
70▲†	Small Format Interchangeable disposable plastic construction core	No addition
72▲†	Small Format Interchangeable 6-pin construction core (7-pin with 11 option)	\$75.00
73▲†	Small Format interchangeable core 6-pin Includes MK and GMK keying charges	\$75.00 / cyl
737P▲†	Small Format interchangeable core 7-pin (refer to CK-12 for available keyways) Includes MK and GMK keying charges	\$75.00 / cyl
81▲†	Cylinder to accept Keso (83) and Keso F1 (F183) removable core – no core provided	No addition
F182†	SARGENT Keso Security Cylinder – patented – new key systems	\$91.00 / cyl.
F183▲†	SARGENT Keso Security Removable Core Cylinder – patented – new key systems	\$130.00 / cyl.
82†	SARGENT Keso Security Cylinder (For existing systems only)	\$91.00 / cyl.
83▲†	SARGENT Keso Security Removable Core Cylinder (For existing systems only)	\$130.00 / cyl.
84▲†	SARGENT Keso Security Removable Construction Core Cylinder	See CK-18
85	Tactile Warning - Abrasive coating on inside lever	\$49.00
86	Tactile Warning - Abrasive coating on outside lever	\$49.00
87	Tactile Warning - Abrasive coating on both levers	\$98.00
AV	Anti Vandal Pull Trim (available in 32D finish), (Not available with 8270, 8271, 8272, 8273 functions)	\$229.00
BR	SARGENT Bump Resistant Cylinders (N/A w/10, 22, 30, 60, 63, 64, 70, 72, 73, 737P, KESO, SC, & SE options)	\$25.00 /cyl.
DG1	Patented Degree DG1 Key System	No addition
DG160	Hardware prepared for DG1-6300 Lg. Format IC cores, supplied with temporary plastic construction cores	No addition
DG163	Patented Degree DG1 Large Format Interchangeable Core Cylinder - Includes master keying charges	\$83.00
DG164	Hardware prepared for DG1-6300 Lg. Format IC cores, supplied with temporary keyed construction cores	\$83.00
DG2	Patented Degree DG2 Key System incorporating a locking sidebar	\$63.00/cyl.
DG260	Hardware prepared for DG2-6300 Lg. Format IC cores, supplied with temporary plastic construction cores	No addition
DG263	Patented Degree DG2 Large Format Interchangeable Core Cylinder - Includes master keying charges	\$146.00
DG264	Hardware prepared for DG2-6300 Lg. Format IC cores, supplied with temporary keyed construction cores	\$83.00
DG3	Patented Degree DG3 Key System incorporating a locking sidebar and UL437 listed	\$89.00/cyl.
DG360	Hardware prepared for DG3-6300 Lg. Format IC cores, supplied with temporary plastic construction cores	No addition
DG363	Patented Degree DG3 Large Format Interchangeable Core Cylinder - Includes master keying charges	\$172.00
DG364	Hardware prepared for DG3-6300 Lg. Format IC cores, supplied with temporary keyed construction cores	\$83.00
DX	Deadbolt Monitoring (not available with 50, 74)	\$197.00
LB	Extra large thumbturn	\$18.00
LC	Less Cylinder	-\$96.00/cyl.
LX	Latchbolt Monitor – available with all non-deadbolt functions; not available with DX option	\$200.00
OBS	Open Back Strike	\$79.00
RX	Request to Exit	\$206.00
SC▲†	Schlage "C" Keyway cylinder, (Number 41 Cylinder Only, 0 bitted)	No addition
SE▲†	Schlage "E" Keyway cylinder, (Number 41 Cylinder Only, 0 bitted)	No addition
SG	MicroShield® – an antimicrobial powder coat finish	\$73.00
WBS	Wrought Box Strike	No addition

NOTES: ▲ Options not avail. with a standard 50 function lockout cylinder. † Not avail. with 60, 63, 64 options

CPC	Clear Powder Coat over 26D/32D – 8205 x CEH010 x RH x 32D x CPC All orders will continue to be handled as a "special" when CPC is ordered.	\$67.00
-----	---	---------

Experience a safer
and more open world

Copyright © 2002-2021 Sargent Manufacturing Company, an ASSA ABLOY Group company. All rights reserved.
Reproduction in whole or in part without the express written permission of Sargent Manufacturing Company is prohibited.
Contact us at: 800-727-5477 or visit www.sargentlock.com. In Canada contact us at: 800-461-3007 or visit www.assaabloydss.ca

ASSA ABLOY

Escutcheon Designs:
CE
TE
LE1

Lever Design:

H003, H004, H005, H006, H007,
*H008, H009, H010, H011



H010



H011

How to order:

21-8205 x CEH003 x RH x 10BE
Option 21
Function 8205
Rose CE
Lever H010
Hand RH
Finish 10BE

* Handed - specify hand when ordering.

8200 STUDIO COLLECTION WOOSTER SQUARE & GRANT PARK

USA & Canada Prices Effective May 1, 2021

Function		Finish	
		10BE/26D/BSP/WSP	03/04/09/10/10B/10BL/14/15/20D/26/32/32D
Single Cyl			
8204	Storeroom or Closet		
8205	Office or Entry		
8237	Classroom	\$1,373.00	\$1,397.00
8255	Office or Entry		
<hr/>			
8206	Storeroom or Service		
8231	Utility		
8236	Closet		
8256	Office or Inner Entry	\$1,396.00	\$1,420.00
8257, 8258, 8267	Institutional Privacy		
8289	Holdback		
8291	All Purpose Holdback		
<hr/>			
Single Cyl With Deadbolt			
8224	Room Door		
8225	Dormitory or Exit		
8227	Closet or Storeroom		
8228, 8230	Dummy Trim Deadlock		
8235	Storeroom	\$1,426.00	\$1,450.00
8243	Apartment Corridor		
8245	Dormitory or Exit		
8247	Front Door or Apartment Corridor		
8251	Storeroom Deadbolt		
8250	Hotel Guest Lock	\$1,457.00	\$1,481.00
<hr/>			
Double Cyl No Deadbolt			
8216	Apartment or Exit or Public Toilet		
8217	Asylum or Institutional		
8238	Classroom Security Intruder		
8242	Classroom Security Intruder Latchbolt	\$1,478.00	\$1,502.00
8259	School Security		
8290	Classroom Security Holdback		
8292	All Purpose Holdback		
<hr/>			
Double Cyl With Deadbolt			
8226	Store Door		
8229	Dummy Trim Deadlock		
8239, 8240	Classroom Security Intruder		
8241	Classroom Security		
8246	Dormitory or Exit	\$1,499.00	\$1,523.00
8248	Store Door		
8249	Security Deadbolt		
8252	Institutional		
<hr/>			
Electro Mechanical Single Cyl – Specify 12V or 24V			
8270-12V / 8270-24V	Fail Safe	\$1,569.00	\$1,593.00
8271-12V / 8271-24V	Fail Secure		
<hr/>			
Electro Mechanical Double Cyl – Specify 12V or 24V			
8272-12V / 8272-24V	Fail Safe	\$1,626.00	\$1,650.00
8273-12V / 8273-24V	Fail Secure		
<hr/>			
Non Keyed			
8213	Communication or Exit	\$1,205.00	\$1,229.00
8215	Passage or Closet		
8265	Privacy Bedroom or Bath (Latch)	\$1,314.00	\$1,338.00
8266, 8268	Privacy Bedroom or Bath (Deadbolt)	\$1,349.00	\$1,373.00
8293*	Single Dummy Trim	\$538.00	\$562.00
8294	Double Dummy Trim	\$1,021.00	\$1,045.00
8295	Single Dummy Trim w/Lockbody	\$635.00	\$659.00
8296	Double Dummy Trim w/Lockbody	\$1,120.00	\$1,144.00
8297	Double Dummy w/Active Trim	\$1,205.00	\$1,229.00

ML-56 MORTISE LOCKS

For V Series
Indicators
Click / See
Page ML-1A

SARGENT®

ASSA ABLOY

OPTIONS

USA & Canada Prices Effective May 1, 2021

Options	Description	Price
1▲	8200 Line with 1-1/16" wide front for 1-3/8" doors.	\$62.00
3	Stainless steel hub (not available with 8289, 8291 & 8292 functions)	\$69.00
10▲	SARGENT Signature Key System	\$63.00 / cyl.
11†▲	SARGENT XC Key System (not available with 10, 22, SC, SE options)	No addition
1160	SARGENT XC Large Format Interchangeable Plastic Disposable Construction Core	No addition
1163	SARGENT XC Large Format Interchangeable Core Cylinder - Includes masterkeying charges	\$83.00
1164	SARGENT XC Large Format Interchangeable Construction Core Cylinder	\$83.00
1170	Small Format interchangeable disposable construction core - to accept 7 Pin XC permanent core	No addition
11727P	Small Format interchangeable keyed construction core - to accept 7 Pin XC permanent core	\$75.00
11737P	Small Format interchangeable core - to accept 7 pin XC permanent core	\$75.00 /cyl.
21▲†	SARGENT Construction Key System (lost ball) Standard on all new systems established since 5/1/96	\$16.00 / cyl.
22▲†	SARGENT Construction Key System (split key) To be used on pre-established split key systems only	\$32.00 / cyl.
23	Locksets with flat 4 7/8" ANSI strike	No addition
31	Thick Doors - Extended Lip Required - Specify Length C to E - Cylinders - IMPORTANT- See catalog 7800/8200 option page for cylinder limitations - Below charges DO NOT include additional charges for special cylinder requirements	No addition
	Doors up to 2-1/2" thick - lock centered	No addition
	Doors 2-5/8" to 6" thick OR doors 1-3/4" thick w/max 1" paneling one side. For example: Specify 1-3/4" door with panel (Side) on inside or outside	
	Non Keyed function \$50.00 Keyed function \$100.00	
60	SARGENT Large Format Interchangeable Plastic Disposable Construction Core	No addition
63	SARGENT Large Format Interchangeable core cylinder, includes master keying charges	\$83.00 / cyl.
64	SARGENT Large Format Interchangeable Construction Core Cylinder	\$83.00
6573▲†	Small Format 6-Pin Uncombined Core (Refer to CK-12)	\$65.00 / cyl.
65737P▲†	Small Format 7-Pin Uncombined Core (Refer to CK-12)	\$65.00 / cyl.
68	8200 Line furnished with lever handle outside x knob inside (Excludes SLD Detention Knob)	Defaults to 8200 Lever Lock Price
69	8200 Line furnished with lever handle inside x knob outside (Excludes SLD Detention Knob)	Defaults to 8200 Lever Lock Price
70▲†	Small Format Interchangeable disposable plastic construction core	No addition
72▲†	Small Format Interchangeable 6-pin construction core (7-pin with 11 option)	\$75.00
73▲†	Small Format interchangeable core 6-pin Includes MK and GMK keying charges	\$75.00 / cyl
737P▲†	Small Format interchangeable core 7-pin (refer to CK-12 for available keyways) Includes MK and GMK keying charges	\$75.00 / cyl
81▲†	Cylinder to accept Keso (83) and Keso F1 (F183) removable core – no core provided	No addition
F182†	SARGENT Keso Security Cylinder – patented – new key systems	\$91.00 / cyl.
F183▲†	SARGENT Keso Security Removable Core Cylinder – patented – new key systems	\$130.00 / cyl.
82†	SARGENT Keso Security Cylinder (For existing systems only)	\$91.00 / cyl.
83▲†	SARGENT Keso Security Removable Core Cylinder (For existing systems only)	\$130.00 / cyl.
84▲†	SARGENT Keso Security Removable Construction Core Cylinder	See CK-18
85	Tactile Warning - Abrasive coating on inside lever	\$49.00
86	Tactile Warning - Abrasive coating on outside lever	\$49.00
87	Tactile Warning - Abrasive coating on both levers	\$98.00
AV	Anti Vandal Pull Trim (available in 32D finish), (Not available with 8270, 8271, 8272, 8273 functions)	\$229.00
BR	SARGENT Bump Resistant Cylinders (N/A w/10, 22, 30, 60, 63, 64, 70, 72, 73, 737P, KESO, SC, & SE options)	\$25.00 /cyl.
DG1	Patented Degree DG1 Key System	No addition
DG160	Hardware prepared for DG1-6300 Lg. Format IC cores, supplied with temporary plastic construction cores	No addition
DG163	Patented Degree DG1 Large Format Interchangeable Core Cylinder - Includes master keying charges	\$83.00
DG164	Hardware prepared for DG1-6300 Lg. Format IC cores, supplied with temporary keyed construction cores	\$83.00
DG2	Patented Degree DG2 Key System incorporating a locking sidebar	\$63.00/cyl.
DG260	Hardware prepared for DG2-6300 Lg. Format IC cores, supplied with temporary plastic construction cores	No addition
DG263	Patented Degree DG2 Large Format Interchangeable Core Cylinder - Includes master keying charges	\$146.00
DG264	Hardware prepared for DG2-6300 Lg. Format IC cores, supplied with temporary keyed construction cores	\$83.00
DG3	Patented Degree DG3 Key System incorporating a locking sidebar and UL437 listed	\$89.00/cyl.
DG360	Hardware prepared for DG3-6300 Lg. Format IC cores, supplied with temporary plastic construction cores	No addition
DG363	Patented Degree DG3 Large Format Interchangeable Core Cylinder - Includes master keying charges	\$172.00
DG364	Hardware prepared for DG3-6300 Lg. Format IC cores, supplied with temporary keyed construction cores	\$83.00
DX	Deadbolt Monitoring (not available with 50, 74)	\$197.00
EMA*	"Lock" directional arrow engraving provided for outside LE1 escutcheon trim only	\$48.00
EMB*	"Lock" directional arrow engraving provided for inside LE1 escutcheon trim only	\$48.00
EMC*	"Lock" directional arrow engraving provided for both sides of LE1 escutcheon trim	\$96.00
LB	Extra large thumbturn	\$18.00
LC	Less Cylinder	-\$96.00/cyl.
LX	Latchbolt Monitor – available with all non-deadbolt functions; not available with DX option	\$200.00
OBS	Open Back Strike	\$79.00
RX	Request to Exit	\$206.00
SC▲†	Schlage "C" Keyway cylinder, (Number 41 Cylinder Only, 0 bitted)	No addition
SE▲†	Schlage "E" Keyway cylinder, (Number 41 Cylinder Only, 0 bitted)	No addition
SG	MicroShield® – an antimicrobial powder coat finish	\$73.00
WBS	Wrought Box Strike	No addition

NOTES: ▲ Options not avail. with a standard 50 function lockout cylinder. † Not avail. with 60, 63, 64 options

CPC	Clear Powder Coat over 26D/32D – 8205 x CEMD x RH x 32D x CPC All orders will continue to be handled as a "special" when CPC is ordered.	\$67.00
-----	---	---------

Experience a safer
and more open world

Copyright © 2002-2021 Sargent Manufacturing Company, an ASSA ABLOY Group company. All rights reserved.
Reproduction in whole or in part without the express written permission of Sargent Manufacturing Company is prohibited.
Contact us at: 800-727-5477 or visit www.sargentlock.com. In Canada contact us at: 800-461-3007 or visit www.assaabloydss.ca

ASSA ABLOY

8200 STUDIO COLLECTION

Escutcheon Designs:

CE
TE
LE1
VN1*

Studio Lever Designs:

All Studio Collection Levers
Except for Gramercy, Wooster
Square, & Grant Park.
*MK and MT levers are not avail-
able with VN1 escutcheon.

How to order: 21-8205 x CEMD x RH x 26D

Option 21
Function 8205
Rose CE
Lever MD
Hand RH
Finish 26D

USA & Canada

Prices Effective
May 1, 2021

Function		Finish	
		10BE/26D/BSP/WSP	03/04/09/10/10B/10BL/14/15/20D/26/32/32D
Single Cyl			
8204	Storeroom or Closet		
8205	Office or Entry		
8237	Classroom	\$1,146.00	\$1,170.00
8255	Office or Entry		
8206	Storeroom or Service		
8231	Utility		
8236	Closet		
8256	Office or Inner Entry	\$1,169.00	\$1,193.00
8257, 8258, 8267	Institutional Privacy		
8289	Holdback		
8291	All Purpose Holdback		
Single Cyl With Deadbolt			
8224	Room Door		
8225	Dormitory or Exit		
8227	Closet or Storeroom		
8228, 8230	Dummy Trim Deadlock		
8235	Storeroom	\$1,201.00	\$1,225.00
8243	Apartment Corridor		
8245	Dormitory or Exit		
8247	Front Door or Apartment Corridor		
8251	Storeroom Deadbolt		
8250	Hotel Guest Lock	\$1,246.00	\$1,270.00
Double Cyl No Deadbolt			
8216	Apartment or Exit or Public Toilet		
8217	Asylum or Institutional		
8238	Classroom Security Intruder	\$1,255.00	\$1,279.00
8242	Classroom Security Intruder Latchbolt		
8259	School Security		
8290	Classroom Security Holdback		
8292	All Purpose Holdback		
Double Cyl With Deadbolt			
8226	Store Door		
8229	Dummy Trim Deadlock		
8239, 8240	Classroom Security Intruder		
8241	Classroom Security	\$1,283.00	\$1,307.00
8246	Dormitory or Exit		
8248	Store Door		
8249	Security Deadbolt		
8252	Institutional		
Electro Mechanical Single Cyl – Specify 12V or 24V			
8270-12V / 8270-24V	Fail Safe	\$1,342.00	\$1,366.00
8271-12V / 8271-24V	Fail Secure		
Electro Mechanical Double Cyl – Specify 12V or 24V			
8272-12V / 8272-24V	Fail Safe	\$1,399.00	\$1,423.00
8273-12V / 8273-24V	Fail Secure		
Non Keyed			
8213	Communication or Exit	\$917.00	\$941.00
8215	Passage or Closet		
8265	Privacy Bedroom or Bath (Latch)	\$1,024.00	\$1,048.00
8266, 8268	Privacy Bedroom or Bath (Deadbolt)	\$1,085.00	\$1,109.00
8293*	Single Dummy Trim	\$379.00	\$391.00
8294	Double Dummy Trim	\$756.00	\$780.00
8295	Single Dummy Trim w/Lockbody	\$483.00	\$495.00
8296	Double Dummy Trim w/Lockbody	\$862.00	\$886.00
8297	Double Dummy w/Active Trim	\$950.00	\$974.00

ML-58 MORTISE LOCKS

For V Series
Indicators
Click / See
Page ML-1A

SARGENT®

ASSA ABLOY

OPTIONS USA & Canada Prices Effective May 1, 2021

Options	Description	Price
1▲	8200 Line with 1-1/16" wide front for 1-3/8" doors.	\$62.00
3	Stainless steel hub (not available with 8289, 8291 & 8292 functions)	\$69.00
10▲	SARGENT Signature Key System	\$63.00 / cyl.
11†▲	SARGENT XC Key System (not available with 10, 22, SC, SE options)	No addition
1160	SARGENT XC Large Format Interchangeable Plastic Disposable Construction Core	No addition
1163	SARGENT XC Large Format Interchangeable Core Cylinder - Includes masterkeying charges	\$83.00
1164	SARGENT XC Large Format Interchangeable Construction Core Cylinder	\$83.00
1170	Small Format interchangeable disposable construction core - to accept 7 Pin XC permanent core	No addition
11727P	Small Format interchangeable keyed construction core - to accept 7 Pin XC permanent core	\$75.00
11737P	Small Format interchangeable core - to accept 7 pin XC permanent core	\$75.00 / cyl.
21▲†	SARGENT Construction Key System (lost ball) Standard on all new systems established since 5/1/96	\$16.00 / cyl.
22▲†	SARGENT Construction Key System (split key) To be used on pre-established split key systems only	\$32.00 / cyl.
23	Locksets with flat 4 7/8" ANSI strike	No addition
31	Thick Doors - Extended Lip Required - Specify Length C to E	
	- Cylinders - IMPORTANT- See catalog 7800/8200 option page for cylinder limitations	
	- Below charges DO NOT include additional charges for special cylinder requirements	
	Doors up to 2-1/2" thick - lock centered	No addition
	Doors 2-5/8" to 6" thick OR doors 1-3/4" thick w/max 1" paneling one side.	
	For example: Specify 1-3/4" door with panel (Side) on inside or outside	
	Non Keyed function \$50.00 Keyed function \$100.00	
60	SARGENT Large Format Interchangeable Plastic Disposable Construction Core	No addition
63	SARGENT Large Format Interchangeable core cylinder, includes master keying charges	\$83.00 / cyl.
64	SARGENT Large Format Interchangeable Construction Core Cylinder	\$83.00
6573▲†	Small Format 6-Pin Uncombined Core (Refer to CK-12)	\$65.00 / cyl.
65737P▲†	Small Format 7-Pin Uncombined Core (Refer to CK-12)	\$65.00 / cyl.
68	8200 Line furnished with lever handle outside x knob inside (Excludes SLD Detention Knob)	Defaults to 8200 Lever Lock Price
69	8200 Line furnished with lever handle inside x knob outside (Excludes SLD Detention Knob)	Defaults to 8200 Lever Lock Price
70▲†	Small Format Interchangeable disposable plastic construction core	No addition
72▲†	Small Format Interchangeable 6-pin construction core (7-pin with 11 option)	\$75.00
73▲†	Small Format interchangeable core 6-pin Includes MK and GMK keying charges	\$75.00 / cyl
737P▲†	Small Format interchangeable core 7-pin (refer to CK-12 for available keyways) Includes MK and GMK keying charges	\$75.00 / cyl
81▲†	Cylinder to accept Keso (83) and Keso F1 (F183) removable core – no core provided	No addition
F182†	SARGENT Keso Security Cylinder – patented – new key systems	\$91.00 / cyl.
F183▲†	SARGENT Keso Security Removable Core Cylinder – patented – new key systems	\$130.00 / cyl.
82†	SARGENT Keso Security Cylinder (For existing systems only)	\$91.00 / cyl.
83▲†	SARGENT Keso Security Removable Core Cylinder (For existing systems only)	\$130.00 / cyl.
84▲†	SARGENT Keso Security Removable Construction Core Cylinder	See CK-18
85	Tactile Warning - Abrasive coating on inside lever	\$49.00
86	Tactile Warning - Abrasive coating on outside lever	\$49.00
87	Tactile Warning - Abrasive coating on both levers	\$98.00
AV	Anti Vandal Pull Trim (available in 32D finish), (Not available with 8270, 8271, 8272, 8273 functions)	\$229.00
BR	SARGENT Bump Resistant Cylinders (N/A w/10, 22, 30, 60, 63, 64, 70, 72, 73, 737P, KESO, SC, & SE options)	\$25.00 / cyl.
DG1	Patented Degree DG1 Key System	No addition
DG160	Hardware prepared for DG1-6300 Lg. Format IC cores, supplied with temporary plastic construction cores	No addition
DG163	Patented Degree DG1 Large Format Interchangeable Core Cylinder - Includes master keying charges	\$83.00
DG164	Hardware prepared for DG1-6300 Lg. Format IC cores, supplied with temporary keyed construction cores	\$83.00
DG2	Patented Degree DG2 Key System incorporating a locking sidebar	\$63.00/cyl.
DG260	Hardware prepared for DG2-6300 Lg. Format IC cores, supplied with temporary plastic construction cores	No addition
DG263	Patented Degree DG2 Large Format Interchangeable Core Cylinder - Includes master keying charges	\$146.00
DG264	Hardware prepared for DG2-6300 Lg. Format IC cores, supplied with temporary keyed construction cores	\$83.00
DG3	Patented Degree DG3 Key System incorporating a locking sidebar and UL437 listed	\$89.00/cyl.
DG360	Hardware prepared for DG3-6300 Lg. Format IC cores, supplied with temporary plastic construction cores	No addition
DG363	Patented Degree DG3 Large Format Interchangeable Core Cylinder - Includes master keying charges	\$172.00
DG364	Hardware prepared for DG3-6300 Lg. Format IC cores, supplied with temporary keyed construction cores	\$83.00
IDP	Integrated Door Position Switch	\$108.00
LB	Extra large thumbturn	\$18.00
LC	Less Cylinder	-\$96.00/cyl.
OBS	Open Back Strike	\$79.00
PHR	Deadbolt Privacy Function (available w/deadbolt function only)	\$100.00
R01	Mercury and Lenel compatible 1KΩ/2KΩ resistance supervision	\$100.00
R03	Software House compatible 1KΩ/2KΩ resistance supervision	\$100.00
R04	AMAG compatible 4-state supervision	\$100.00
SC▲†	Schlage "C" Keyway cylinder, (Number 41 Cylinder Only, 0 bitting)	No addition
SE▲†	Schlage "E" Keyway cylinder, (Number 41 Cylinder Only, 0 bitting)	No addition
SG	MicroShield® – an antimicrobial powder coat finish	\$73.00
WBS	Wrought Box Strike	No addition

NOTES: ▲ Options not avail. with a standard 50 function lockout cylinder. † Not avail. with 60, 63, 64 options

CPC Clear Powder Coat over 26D/32D – NAC-82280-24V x CEMD x RH x 32D x CPC \$67.00
All orders will continue to be handled as a "special" when CPC is ordered.

Experience a safer
and more open world

Copyright © 2002-2021 Sargent Manufacturing Company, an ASSA ABLOY Group company. All rights reserved.
Reproduction in whole or in part without the express written permission of Sargent Manufacturing Company is prohibited.
Contact us at: 800-727-5477 or visit www.sargentlock.com. In Canada contact us at: 800-461-3007 or visit www.assaabloydss.ca

USA & Canada Prices Effective May 1, 2021

Escutcheon Designs:

CE
TE
LE1
VN1*

Studio Lever Designs:

All Studio Collection Levers
Except for Gramercy, Wooster
Square, & Grant Park.
*MK and MT levers are not
available with VN1 escutcheon.

How to order: NAC-82280-24V x CEMD x RH x 26D

Option NAC
Function 82280-24V
Rose CE
Lever MD
Hand RH
Finish 26D

NAC 8200 Electrified Mortise Locks with High Security Monitoring				10BE/26D/ BSP/WSP	03/04/09/10/ 10B/10BL/14/15/ 20D/26/32/32D
Option	Function	Trim - Proximity Entry	Description		
NAC	82270-12V/-24V	Rose x Lever Design	Fail Safe w/Cylinder Override	\$1,517.00	\$1,541.00
NAC	82271-12V/-24V	Rose x Lever Design	Fail Secure w/Cylinder Override		
NAC	82280-12V/-24V	Rose x Lever Design	Fail Safe w/Deadbolt w/Cyl.Override	\$1,592.00	\$1,616.00
NAC	82281-12V/-24V	Rose x Lever Design	Fail Secure w/D.bolt w/Cyl.Override		
NAC	82274-12V/-24V	Rose x Lever Design	Fail Safe - No Cylinder	\$1,462.00	\$1,486.00
NAC	82275-12V/-24V	Rose x Lever Design	Fail Secure - No Cylinder		
NAC	82284-12V/-24V	Rose x Lever Design	Fail Safe w/Deadbolt - No Cylinder	\$1,537.00	\$1,561.00
NAC	82285-12V/-24V	Rose x Lever Design	Fail Secure w/Deadbolt - No Cylinder		

Note: Consult catalog for ordering information.

Specify hand and voltage (12v or 24v) when ordering

ML-60 MORTISE LOCKS

For V Series
Indicators
Click / See
Page ML-1A

SARGENT®

ASSA ABLOY

OPTIONS

USA & Canada Prices Effective May 1, 2021

Options	Description	Price
1▲	8200 Line with 1-1/16" wide front for 1-3/8" doors.	\$62.00
3	Stainless steel hub (not available with 8289, 8291 & 8292 functions)	\$69.00
10▲	SARGENT Signature Key System	\$63.00 / cyl.
11†▲	SARGENT XC Key System (not available with 10, 22, SC, SE options)	No addition
1160	SARGENT XC Large Format Interchangeable Plastic Disposable Construction Core	No addition
1163	SARGENT XC Large Format Interchangeable Core Cylinder - Includes masterkeying charges	\$83.00
1164	SARGENT XC Large Format Interchangeable Construction Core Cylinder	\$83.00
1170	Small Format interchangeable disposable construction core - to accept 7 Pin XC permanent core	No addition
11727P	Small Format interchangeable keyed construction core - to accept 7 Pin XC permanent core	\$75.00
11737P	Small Format interchangeable core - to accept 7 pin XC permanent core	\$75.00 / cyl.
21▲†	SARGENT Construction Key System (lost ball) Standard on all new systems established since 5/1/96	\$16.00 / cyl.
22▲†	SARGENT Construction Key System (split key) To be used on pre-established split key systems only	\$32.00 / cyl.
23	Locksets with flat 4 7/8" ANSI strike	No addition
31	Thick Doors - Extended Lip Required - Specify Length C to E - Cylinders - IMPORTANT- See catalog 7800/8200 option page for cylinder limitations - Below charges DO NOT include additional charges for special cylinder requirements	
	Doors up to 2-1/2" thick - lock centered	No addition
	Doors 2-5/8" to 6" thick OR doors 1-3/4" thick w/max 1" paneling one side.	
	For example: Specify 1-3/4" door with panel (Side) on inside or outside	Non Keyed function \$50.00 Keyed function \$100.00
49	Visual Status Indicator - Available with 30, 36, 37 function - Rose Trims CR, E, L, LN, O, TR - Available with 26, 29, 38, 39 40, 41 functions - Rose Trim 8200 LN	\$140.00
49	Occupancy Indicator with emergency Release - Available with 65, 66, 68 functions; Rose Trims 7800 CR, E, L, LN, O, TR	\$140.00
50	Secured Indicator Rose- doors 1-5/8" to 2-1/4" thick- Avail.w/24,25,26,28,29,30,36,37,38,39,40,41,43,45,50,51,52,57,58,67 functions	\$140.00
60	SARGENT Large Format Interchangeable Plastic Disposable Construction Core	No addition
63	SARGENT Large Format Interchangeable core cylinder, includes master keying charges	\$83.00 / cyl.
64	SARGENT Large Format Interchangeable Construction Core Cylinder	\$83.00
6573▲†	Small Format 6-Pin Uncombined Core (Refer to CK-12)	\$65.00 / cyl.
65737P▲†	Small Format 7-Pin Uncombined Core (Refer to CK-12)	\$65.00 / cyl.
68	8200 Line furnished with lever handle outside x knob inside (Excludes SLD Detention Knob)	Defaults to 8200 Lever Lock Price
69	8200 Line furnished with lever handle inside x knob outside (Excludes SLD Detention Knob)	Defaults to 8200 Lever Lock Price
70▲†	Small Format Interchangeable disposable plastic construction core	No addition
72▲†	Small Format Interchangeable 6-pin construction core (7-pin with 11 option)	\$75.00
73▲†	Small Format interchangeable core 6-pin Includes MK and GMK keying charges	\$75.00 / cyl
737P▲†	Small Format interchangeable core 7-pin (refer to CK-12 for available keyways) Includes MK and GMK keying charges	\$75.00 / cyl
74	Lock case wrapped in lead - handing required (roses not available)	\$294.00
81▲†	Cylinder to accept Keso (83) and Keso F1 (F183) removable core - no core provided	No addition
F182†	SARGENT Keso Security Cylinder - patented - new key systems	\$91.00 / cyl.
F183▲†	SARGENT Keso Security Removable Core Cylinder - patented - new key systems	\$130.00 / cyl.
82†	SARGENT Keso Security Cylinder (For existing systems only)	\$91.00 / cyl.
83▲†	SARGENT Keso Security Removable Core Cylinder (For existing systems only)	\$130.00 / cyl.
84▲†	SARGENT Keso Security Removable Construction Core Cylinder	See CK-18
AV	Anti Vandal Pull Trim (available in 32D finish), (Not available with 8270, 8271, 8272, 8273 functions)	\$229.00
BR	SARGENT Bump Resistant Cylinders (N/A w/10, 22, 30, 60, 63, 64, 70, 72, 73, 737P, KESO, SC, & SE options)	\$25.00 /cyl.
DG1	Patented Degree DG1 Key System	No addition
DG160	Hardware prepared for DG1-6300 Lg. Format IC cores, supplied with temporary plastic construction cores	No addition
DG163	Patented Degree DG1 Large Format Interchangeable Core Cylinder - Includes master keying charges	\$83.00
DG164	Hardware prepared for DG1-6300 Lg. Format IC cores, supplied with temporary keyed construction cores	\$83.00
DG2	Patented Degree DG2 Key System incorporating a locking sidebar	\$63.00/cyl.
DG260	Hardware prepared for DG2-6300 Lg. Format IC cores, supplied with temporary plastic construction cores	No addition
DG263	Patented Degree DG2 Large Format Interchangeable Core Cylinder - Includes master keying charges	\$146.00
DG264	Hardware prepared for DG2-6300 Lg. Format IC cores, supplied with temporary keyed construction cores	\$83.00
DG3	Patented Degree DG3 Key System incorporating a locking sidebar and UL437 listed	\$89.00/cyl.
DG360	Hardware prepared for DG3-6300 Lg. Format IC cores, supplied with temporary plastic construction cores	No addition
DG363	Patented Degree DG3 Large Format Interchangeable Core Cylinder - Includes master keying charges	\$172.00
DG364	Hardware prepared for DG3-6300 Lg. Format IC cores, supplied with temporary keyed construction cores	See CK-2
DX	Deadbolt Monitoring (not available with 50, 74)	\$197.00
LC	Less Cylinder	-\$96.00/cyl.
LB	Extra large thumbturn	\$18.00
LX	Latchbolt Monitor - available with all non-deadbolt functions; not available with DX option	\$200.00
OBS	Open Back Strike	\$79.00
RX	Request to Exit	\$206.00
SC▲†	Schlage "C" Keyway cylinder, (Number 41 Cylinder Only, 0 bitted)	No addition
SE▲†	Schlage "E" Keyway cylinder, (Number 41 Cylinder Only, 0 bitted)	No addition
SG	MicroShield® - an antimicrobial powder coat finish (Not available with RAS lever)	\$73.00
T1	Decorative thumbturn; backplate matches rose design chosen	No Addition
T2	Decorative square thumbturn; backplate matches rose design chosen	No Addition
T3	Decorative cylinder thumbturn; backplate matches rose design chosen	No Addition
WBS	Wrought Box Strike	No addition

NOTES: ▲ Options not avail. with a standard 50 function lockout cylinder. † Not avail. with 60, 63, 64 options

CPC	Clear Powder Coat over 26D/32D - 8205 x CRREM x RH x 32D x CPC All orders will continue to be handled as a "special" when CPC is ordered.	\$67.00
-----	--	---------

Experience a safer
and more open world

Copyright © 2002-2021 Sargent Manufacturing Company, an ASSA ABLOY Group company. All rights reserved.
Reproduction in whole or in part without the express written permission of Sargent Manufacturing Company is prohibited.
Contact us at: 800-727-5477 or visit www.sargentlock.com. In Canada contact us at: 800-461-3007 or visit www.assaabloydss.ca

ASSA ABLOY

8200 STUDIO COLLECTION - GRAMERCY SERIES

USA & Canada Prices Effective May 1, 2021

Rose Design:

CO (2-3/4")
CR (2-3/16")
LN (2")
O (2-3/4")
TO (2-3/4")
TR (2-3/16")
E2 (2-11/16")
E3 (2-1/16")
E4 (3-1/3")

Lever Design:

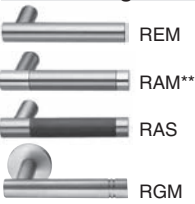

How to order Gramercy Series Levers:

Option: 63 x Function: 8204 x Rose: LN x Lever: RAS x Finish: 29BK29 x Hand: RH
See below for available finishes:

Lever Design	Available Finishes
REM-RGM	2929, 3030, 3E3E, BSBS, WSWWS
RAM	2930*
RAS	29BK29, 30BK30, 3E3E, BSBS, WSWWS

*Two-tone - grip of lever is 32D, balance of lever is 32. Rose/escutcheon and lock finish will be 32.
See catalog for finish description.

**RAM is not available in 10BE/BSP/WSP finish.

Function – Single Cylinder		Finish – 10BE/BSP/WSP/629/630
8204	Storeroom or Closet	
8205	Office or Entry	\$1,211.00
8237	Classroom	
8255	Office or Entry	
8206	Storeroom or Service	
8231	Utility	
8236	Closet	
8256	Office or Inner Entry	\$1,235.00
8257, 8258, 8267	Institutional Privacy	
8289	Holdback	
8291	All Purpose Holdback	
Single Cylinder With Deadbolt		
8224	Room Door	
8225	Dormitory or Exit	
8227	Closet or Storeroom	
8228, 8230	Dummy Trim Deadlock	
8235	Storeroom	\$1,263.00
8243	Apartment Corridor	
8245	Dormitory or Exit	
8247	Front Door or Apartment Corridor	
8251	Storeroom Deadbolt	
8250	Hotel Guest Lock	\$1,303.00
Double Cylinder No Deadbolt		
8216	Apartment or Exit or Public Toilet	
8217	Asylum or Institutional	
8238	Classroom Security Intruder	\$1,314.00
8242	Classroom Security Intruder Latchbolt	
8259	School Security	
8290	Classroom Security Holdback	
8292	All Purpose Holdback	
Double Cylinder With Deadbolt		
8226	Store Door	
8229	Dummy Trim Deadlock	
8239, 8240	Classroom Security Intruder	
8241	Classroom Security	\$1,338.00
8246	Dormitory or Exit	
8248	Store Door	
8249	Security	
8252	Institutional	
Electro Mechanical Single Cylinder – Specify 12V or 24V		
8270-12V / 8270-24V	Fail Safe	\$1,407.00
8271-12V / 8271-24V	Fail Secure	
Electro Mechanical Double Cylinder – Specify 12V or 24V		
8272-12V / 8272-24V	Fail Safe	\$1,464.00
8273-12V / 8273-24V	Fail Secure	
Non Keyed		
8213	Communication or Exit	\$1,044.00
8215	Passage or Closet	
8265	Privacy Bedroom or Bath (Latch)	\$1,153.00
8266, 8268	Privacy Bedroom or Bath (Deadbolt)	\$1,190.00
8293*	Single Dummy Trim	\$432.00
8294	Double Dummy Trim	\$860.00
8295	Single Dummy Trim w/Lockbody	\$530.00
8296	Double Dummy Trim w/Lockbody	\$958.00
8297	Double Dummy w/Active Trim	\$1,044.00

ML-62 MORTISE LOCKS

**For V Series
Indicators
Click / See
Page ML-1A**

SARGENT®

ASSA ABLOY

OPTIONS

USA & Canada Prices Effective May 1, 2021

Options	Description	Price
1▲	8200 Line with 1-1/16" wide front for 1-3/8" doors.	\$62.00
3	Stainless steel hub (not available with 8289, 8291 & 8292 functions)	\$69.00
10▲	SARGENT Signature Key System	\$63.00 / cyl.
11†▲	SARGENT XC Key System (not available with 10, 22, SC, SE options)	No addition
1160	SARGENT XC Large Format Interchangeable Plastic Disposable Construction Core	No addition
1163	SARGENT XC Large Format Interchangeable Core Cylinder - Includes masterkeying charges	\$83.00
1164	SARGENT XC Large Format Interchangeable Construction Core Cylinder	\$83.00
1170	Small Format interchangeable disposable construction core - to accept 7 Pin XC permanent core	No addition
11727P	Small Format interchangeable keyed construction core - to accept 7 Pin XC permanent core	\$75.00
11737P	Small Format interchangeable core - to accept 7 pin XC permanent core	\$75.00 /cyl.
21▲†	SARGENT Construction Key System (lost ball) Standard on all new systems established since 5/1/96	\$16.00 / cyl.
22▲†	SARGENT Construction Key System (split key) To be used on pre-established split key systems only	\$32.00 / cyl.
23	Locksets with flat 4 7/8" ANSI strike	No addition
31	Thick Doors - Extended Lip Required - Specify Length C to E	
	- Cylinders - IMPORTANT- See catalog 7800/8200 option page for cylinder limitations	
	- Below charges DO NOT include additional charges for special cylinder requirements	
	Doors up to 2-1/2" thick - lock centered	No addition
	Doors 2-5/8" to 6" thick OR doors 1-3/4" thick w/max 1" paneling one side.	
	For example: Specify 1-3/4" door with panel (Side) on inside or outside	
	Non Keyed function \$50.00 Keyed function \$100.00	
60	SARGENT Large Format Interchangeable Plastic Disposable Construction Core	No addition
63	SARGENT Large Format Interchangeable core cylinder, includes master keying charges	\$83.00 / cyl.
64	SARGENT Large Format Interchangeable Construction Core Cylinder	\$83.00
6573▲†	Small Format 6-Pin Uncombined Core (Refer to CK-12)	\$65.00 / cyl.
65737P▲†	Small Format 7-Pin Uncombined Core (Refer to CK-12)	\$65.00 / cyl.
68	8200 Line furnished with lever handle outside x knob inside (Excludes SLD Detention Knob)	Defaults to 8200 Lever Lock Price
69	8200 Line furnished with lever handle inside x knob outside (Excludes SLD Detention Knob)	Defaults to 8200 Lever Lock Price
70▲†	Small Format Interchangeable disposable plastic construction core	No addition
72▲†	Small Format Interchangeable 6-pin construction core (7-pin with 11 option)	\$75.00
73▲†	Small Format interchangeable core 6-pin Includes MK and GMK keying charges	\$75.00 / cyl
737P▲†	Small Format interchangeable core 7-pin (refer to CK-12 for available keyways) Includes MK and GMK keying charges	\$75.00 / cyl
81▲†	Cylinder to accept Keso (83) and Keso F1 (F183) removable core – no core provided	No addition
F182†	SARGENT Keso Security Cylinder – patented – new key systems	\$91.00 / cyl.
F183▲†	SARGENT Keso Security Removable Core Cylinder – patented – new key systems	\$130.00 / cyl.
82†	SARGENT Keso Security Cylinder (For existing systems only)	\$91.00 / cyl.
83▲†	SARGENT Keso Security Removable Core Cylinder (For existing systems only)	\$130.00 / cyl.
84▲†	SARGENT Keso Security Removable Construction Core Cylinder	See CK-18
85	Tactile Warning - Abrasive coating on inside lever	\$49.00
86	Tactile Warning - Abrasive coating on outside lever	\$49.00
87	Tactile Warning - Abrasive coating on both levers	\$98.00
AV	Anti Vandal Pull Trim (available in 32D finish), (Not available with 8270, 8271, 8272, 8273 functions)	\$229.00
BR	SARGENT Bump Resistant Cylinders (N/A w/10, 22, 30, 60, 63, 64, 70, 72, 73, 737P, KESO, SC, & SE options)	\$25.00 /cyl.
DG1	Patented Degree DG1 Key System	No addition
DG160	Hardware prepared for DG1-6300 Lg. Format IC cores, supplied with temporary plastic construction cores	No addition
DG163	Patented Degree DG1 Large Format Interchangeable Core Cylinder - Includes master keying charges	\$83.00
DG164	Hardware prepared for DG1-6300 Lg. Format IC cores, supplied with temporary keyed construction cores	\$83.00
DG2	Patented Degree DG2 Key System incorporating a locking sidebar	\$63.00/cyl.
DG260	Hardware prepared for DG2-6300 Lg. Format IC cores, supplied with temporary plastic construction cores	No addition
DG263	Patented Degree DG2 Large Format Interchangeable Core Cylinder - Includes master keying charges	\$146.00
DG264	Hardware prepared for DG2-6300 Lg. Format IC cores, supplied with temporary keyed construction cores	\$83.00
DG3	Patented Degree DG3 Key System incorporating a locking sidebar and UL437 listed	\$89.00/cyl.
DG360	Hardware prepared for DG3-6300 Lg. Format IC cores, supplied with temporary plastic construction cores	No addition
DG363	Patented Degree DG3 Large Format Interchangeable Core Cylinder - Includes master keying charges	\$172.00
DG364	Hardware prepared for DG3-6300 Lg. Format IC cores, supplied with temporary keyed construction cores	\$83.00
IDP	Integrated Door Position Switch	\$108.00
LB	Extra large thumbturn	\$18.00
LC	Less Cylinder	-\$96.00/cyl.
OBS	Open Back Strike	\$79.00
PHR	Deadbolt Privacy Function (available w/deadbolt function only)	\$100.00
R01	Mercury and Lenel compatible 1KΩ/2KΩ resistance supervision	\$100.00
R03	Software House compatible 1KΩ/2KΩ resistance supervision	\$100.00
R04	AMAG compatible 4-state supervision	\$100.00
SC▲†	Schlage "C" Keyway cylinder, (Number 41 Cylinder Only, 0 bitted)	No addition
SE▲†	Schlage "E" Keyway cylinder, (Number 41 Cylinder Only, 0 bitted)	No addition
SG	MicroShield® – an antimicrobial powder coat finish	\$73.00
WBS	Wrought Box Strike	No addition

NOTES: ▲ Options not avail. with a standard 50 function lockout cylinder. † Not avail. with 60, 63, 64 options

CPC	Clear Powder Coat over 26D/32D – NAC-82280-24V x CEMD x RH x 32D x CPC	\$67.00
	All orders will continue to be handled as a "special" when CPC is ordered.	

Experience a safer
and more open world

Copyright © 2002-2021 Sargent Manufacturing Company, an ASSA ABLOY Group company. All rights reserved.
Reproduction in whole or in part without the express written permission of Sargent Manufacturing Company is prohibited.
Contact us at: 800-727-5477 or visit www.sargentlock.com. In Canada contact us at: 800-461-3007 or visit www.assaabloydss.ca

Rose Design:

- CO (2-3/4")
- CR (2-3/16")
- LN (2")
- O (2-3/4")
- TO (2-3/4")
- TR (2-3/16")
- E2 (2-11/16")
- E3 (2-1/16")
- E4 (3-1/3")

Lever Design:

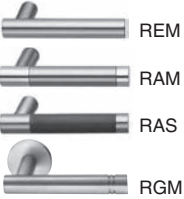

How to order Gramercy Series Levers:

Option: NAC x Function: 82271-24V x Rose: LN x Lever: RAS x Finish: 29BK29 x Hand: RH

See below for available finishes:

Lever Design Available Finishes

REM-RGM	2929, 3030, 3E3E, BSBS, WSWWS
RAM	2930*
RAS	29BK29, 30BK30, 3E3E, BSBS, WSWWS

*Two-tone - grip of lever is 32D, balance of lever is 32. Rose/escutcheon and lock finish will be 32. See catalog for finish description.

**RAM is not available in 10BE/BSP/WSP finish.

NAC 8200 Electrified Mortise Locks with High Security Monitoring				10BE/BSP/WSP/ 629/630
Option	Function	Trim - Proximity Entry	Description	
NAC	82270-12V/-24V	Rose x Lever Design	Fail Safe w/Cylinder Override	\$1,582.00
NAC	82271-12V/-24V	Rose x Lever Design	Fail Secure w/Cylinder Override	
NAC	82280-12V/-24V	Rose x Lever Design	Fail Safe w/Deadbolt w/Cyl.Override	\$1,657.00
NAC	82281-12V/-24V	Rose x Lever Design	Fail Secure w/D.bolt w/Cyl.Override	
NAC	82274-12V/-24V	Rose x Lever Design	Fail Safe - No Cylinder	\$1,527.00
NAC	82275-12V/-24V	Rose x Lever Design	Fail Secure - No Cylinder	
NAC	82284-12V/-24V	Rose x Lever Design	Fail Safe w/Deadbolt - No Cylinder	\$1,602.00
NAC	82285-12V/-24V	Rose x Lever Design	Fail Secure w/Deadbolt - No Cylinder	

Note: Consult catalog for ordering information.

Specify hand and voltage (12v or 24v) when ordering

ML-64 MORTISE LOCKS

For V Series
Indicators
Click / See
Page ML-1A

SARGENT®

ASSA ABLOY

OPTIONS

USA & Canada Prices Effective May 1, 2021

Options	Description	Price
1▲	8200 Line with 1-1/16" wide front for 1-3/8" doors.	\$62.00
3	Stainless steel hub (not available with 8289, 8291 & 8292 functions)	\$69.00
10▲	SARGENT Signature Key System	\$63.00 / cyl.
11†▲	SARGENT XC Key System (not available with 10, 22, SC, SE options)	No addition
1160	SARGENT XC Large Format Interchangeable Plastic Disposable Construction Core	No addition
1163	SARGENT XC Large Format Interchangeable Core Cylinder - Includes masterkeying charges	\$83.00
1164	SARGENT XC Large Format Interchangeable Construction Core Cylinder	\$83.00
1170	Small Format interchangeable disposable construction core - to accept 7 Pin XC permanent core	No addition
11727P	Small Format interchangeable keyed construction core - to accept 7 Pin XC permanent core	\$75.00
11737P	Small Format interchangeable core - to accept 7 pin XC permanent core	\$75.00 /cyl.
21▲†	SARGENT Construction Key System (lost ball) Standard on all new systems established since 5/1/96	\$16.00 / cyl.
22▲†	SARGENT Construction Key System (split key) To be used on pre-established split key systems only	\$32.00 / cyl.
23	Locksets with flat 4 7/8" ANSI strike	No addition
31	Thick Doors - Extended Lip Required - Specify Length C to E - Cylinders - IMPORTANT- See catalog 7800/8200 option page for cylinder limitations - Below charges DO NOT include additional charges for special cylinder requirements Doors up to 2-1/2" thick - lock centered Doors 2-5/8" to 6" thick OR doors 1-3/4" thick w/max 1" paneling one side. For example: Specify 1-3/4" door with panel (Side) on inside or outside	No addition Non Keyed function \$50.00 Keyed function \$100.00
49	Visual Status Indicator - Available with 30, 36, 37 function - Rose Trims CR, E, L, LN, O, TR - Available with 26, 29, 38, 39 40, 41 functions - Rose Trim 8200 LN	\$140.00
49	Occupancy Indicator with emergency Release - Available with 65, 66, 68 functions; Rose Trims 7800 CR, E, L, LN, O, TR	\$140.00
50	Secured Indicator Rose- doors 1-5/8" to 2-1/4" thick- Avail.w/24,25,26,28,29,30,36,37,38,39,40,41,43,45,50,51,52,57,58,67 functions	\$140.00
60	SARGENT Large Format Interchangeable Plastic Disposable Construction Core	No addition
63	SARGENT Large Format Interchangeable core cylinder, includes master keying charges	\$83.00 / cyl.
64	SARGENT Large Format Interchangeable Construction Core Cylinder	\$83.00
6573▲†	Small Format 6-Pin Uncombined Core (Refer to CK-12)	\$65.00 / cyl.
65737P▲†	Small Format 7-Pin Uncombined Core (Refer to CK-12)	\$65.00 / cyl.
68	8200 Line furnished with lever handle outside x knob inside (Excludes SLD Detention Knob)	Defaults to 8200 Lever Lock Price
69	8200 Line furnished with lever handle inside x knob outside (Excludes SLD Detention Knob)	Defaults to 8200 Lever Lock Price
70▲†	Small Format Interchangeable disposable plastic construction core	No addition
72▲†	Small Format Interchangeable 6-pin construction core (7-pin with 11 option)	\$75.00
73▲†	Small Format interchangeable core 6-pin Includes MK and GMK keying charges	\$75.00 / cyl
737P▲†	Small Format interchangeable core 7-pin (refer to CK-12 for available keyways) Includes MK and GMK keying charges	\$75.00 / cyl
74	Lock case wrapped in lead - handing required (roses not available)	\$294.00
81▲†	Cylinder to accept Keso (83) and Keso F1 (F183) removable core - no core provided	No addition
F182†	SARGENT Keso Security Cylinder - patented - new key systems	\$91.00 / cyl.
F183▲†	SARGENT Keso Security Removable Core Cylinder - patented - new key systems	\$130.00 / cyl.
82†	SARGENT Keso Security Cylinder (For existing systems only)	\$91.00 / cyl.
83▲†	SARGENT Keso Security Removable Core Cylinder (For existing systems only)	\$130.00 / cyl.
84▲†	SARGENT Keso Security Removable Construction Core Cylinder	See CK-18
AV	Anti Vandal Pull Trim (available in 32D finish), (Not available with 8270, 8271, 8272, 8273 functions)	\$229.00
BR	SARGENT Bump Resistant Cylinders (N/A w/10, 22, 30, 60, 63, 64, 70, 72, 73, 737P, KESO, SC, & SE options)	\$25.00 /cyl.
DG1	Patented Degree DG1 Key System	No addition
DG160	Hardware prepared for DG1-6300 Lg. Format IC cores, supplied with temporary plastic construction cores	No addition
DG163	Patented Degree DG1 Large Format Interchangeable Core Cylinder - Includes master keying charges	\$83.00
DG164	Hardware prepared for DG1-6300 Lg. Format IC cores, supplied with temporary keyed construction cores	\$83.00
DG2	Patented Degree DG2 Key System incorporating a locking sidebar	\$63.00/cyl.
DG260	Hardware prepared for DG2-6300 Lg. Format IC cores, supplied with temporary plastic construction cores	No addition
DG263	Patented Degree DG2 Large Format Interchangeable Core Cylinder - Includes master keying charges	\$146.00
DG264	Hardware prepared for DG2-6300 Lg. Format IC cores, supplied with temporary keyed construction cores	\$83.00
DG3	Patented Degree DG3 Key System incorporating a locking sidebar and UL437 listed	\$89.00/cyl.
DG360	Hardware prepared for DG3-6300 Lg. Format IC cores, supplied with temporary plastic construction cores	No addition
DG363	Patented Degree DG3 Large Format Interchangeable Core Cylinder - Includes master keying charges	\$172.00
DG364	Hardware prepared for DG3-6300 Lg. Format IC cores, supplied with temporary keyed construction cores	\$83.00
DX	Deadbolt Monitoring (not available with 50, 74)	\$197.00
LC	Less Cylinder	-\$96.00/cyl.
LB	Extra large thumbturn	\$18.00
LX	Latchbolt Monitor - available with all non-deadbolt functions; not available with DX option	\$200.00
OBS	Open Back Strike	\$79.00
RX	Request to Exit	\$206.00
SC▲†	Schlage "C" Keyway cylinder, (Number 41 Cylinder Only, 0 bitted)	No addition
SE▲†	Schlage "E" Keyway cylinder, (Number 41 Cylinder Only, 0 bitted)	No addition
SG	MicroShiel™ - an antimicrobial powder coat finish (Not available with RAL levers)	\$73.00
T1	Decorative thumbturn; backplate matches rose design chosen	No Addition
T2	Decorative square thumbturn; backplate matches rose design chosen	No Addition
T3	Decorative cylinder thumbturn; backplate matches rose design chosen	No Addition
WBS	Wrought Box Strike	No addition

NOTES: ▲ Options not avail. with a standard 50 function lockout cylinder. † Not avail. with 60, 63, 64 options

CPC	Clear Powder Coat over 26D/32D - 8205 x CRRCM x RH x 32D x CPC All orders will continue to be handled as a "special" when CPC is ordered.	\$67.00
-----	--	---------

Experience a safer
and more open world

Copyright © 2002-2021 Sargent Manufacturing Company, an ASSA ABLOY Group company. All rights reserved.
Reproduction in whole or in part without the express written permission of Sargent Manufacturing Company is prohibited.
Contact us at: 800-727-5477 or visit www.sargentlock.com. In Canada contact us at: 800-461-3007 or visit www.assaabloydss.ca

ASSA ABLOY

8200 STUDIO COLLECTION - GRAMERCY SERIES

USA & Canada Prices Effective May 1, 2021

Rose Design:

CO (2-3/4")
CR (2-3/16")
LN (2")
O (2-3/4")
TO (2-3/4")
TR (2-3/16")
E2 (2-11/16")
E3 (2-1/16")
E4 (3-1/3")

Lever Design:

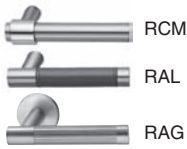

How to order Gramercy Series Levers:

Option: 10 x Function: 8204 x Rose: TQ x Lever: RAL x Finish: 29BK29 x Hand: RH
See below for available finishes:

Lever Design Available Finishes

RCM 2929, 3030, 2930*, 3E3E, BSBS, WSWWS
RAL 29BK29, 29BN29, 30BK30, or 30BN30, 3EBK3E, 3EBN3E, BSBKBS, BSNBNS, WSBKWS, WSNBWS
RAG 2929 or 3030

*Two-tone - grip of lever is 32D, balance of lever is 32. Rose/escutcheon and lock finish will be 32. See catalog for finish description.

Function – Single Cylinder		Finish – 10BE/BSP/WSP/629/630
8204	Storeroom or Closet	
8205	Office or Entry	\$1,298.00
8237	Classroom	
8255	Office or Entry	
8206	Storeroom or Service	
8231	Utility	
8236	Closet	
8256	Office or Inner Entry	\$1,323.00
8257, 8258, 8267	Institutional Privacy	
8289	Holdback	
8291	All Purpose Holdback	
Single Cylinder With Deadbolt		
8224	Room Door	
8225	Dormitory or Exit	
8227	Closet or Storeroom	
8228, 8230	Dummy Trim Deadlock	
8235	Storeroom	\$1,353.00
8243	Apartment Corridor	
8245	Dormitory or Exit	
8247	Front Door or Apartment Corridor	
8251	Storeroom Deadbolt	
8250	Hotel Guest Lock	\$1,392.00
Double Cylinder No Deadbolt		
8216	Apartment or Exit or Public Toilet	
8217	Asylum or Institutional	
8238	Classroom Security Intruder	\$1,402.00
8242	Classroom Security Intruder Latchbolt	
8259	School Security	
8290	Classroom Security Holdback	
8292	All Purpose Holdback	
Double Cylinder With Deadbolt		
8226	Store Door	
8229	Dummy Trim Deadlock	
8239, 8240	Classroom Security Intruder	
8241	Classroom Security	\$1,424.00
8246	Dormitory or Exit	
8248	Store Door	
8249	Security	
8252	Institutional	
Electro Mechanical Single Cylinder – Specify 12V or 24V		
8270-12V / 8270-24V	Fail Safe	\$1,494.00
8271-12V / 8271-24V	Fail Secure	
Electro Mechanical Double Cylinder – Specify 12V or 24V		
8272-12V / 8272-24V	Fail Safe	\$1,551.00
8273-12V / 8273-24V	Fail Secure	
Non Keyed		
8213	Communication or Exit	\$1,132.00
8215	Passage or Closet	
8265	Privacy Bedroom or Bath (Latch)	\$1,238.00
8266, 8268	Privacy Bedroom or Bath (Deadbolt)	\$1,279.00
8293*	Single Dummy Trim	\$518.00
8294	Double Dummy Trim	\$949.00
8295	Single Dummy Trim w/Lockbody	\$617.00
8296	Double Dummy Trim w/Lockbody	\$1,045.00
8297	Double Dummy w/Active Trim	\$1,132.00

OPTIONS

USA & Canada Prices Effective May 1, 2021

Options	Description	Price
1▲	8200 Line with 1-1/16" wide front for 1-3/8" doors.	\$62.00
3	Stainless steel hub (not available with 8289, 8291 & 8292 functions)	\$69.00
10▲	SARGENT Signature Key System	\$63.00 / cyl.
11†▲	SARGENT XC Key System (not available with 10, 22, SC, SE options)	No addition
1160	SARGENT XC Large Format Interchangeable Plastic Disposable Construction Core	No addition
1163	SARGENT XC Large Format Interchangeable Core Cylinder - Includes masterkeying charges	\$83.00
1164	SARGENT XC Large Format Interchangeable Construction Core Cylinder	\$83.00
1170	Small Format interchangeable disposable construction core - to accept 7 Pin XC permanent core	No addition
11727P	Small Format interchangeable keyed construction core - to accept 7 Pin XC permanent core	\$75.00
11737P	Small Format interchangeable core - to accept 7 pin XC permanent core	\$75.00 /cyl.
21▲†	SARGENT Construction Key System (lost ball) Standard on all new systems established since 5/1/96	\$16.00 / cyl.
22▲†	SARGENT Construction Key System (split key) To be used on pre-established split key systems only	\$32.00 / cyl.
23	Locksets with flat 4 7/8" ANSI strike	No addition
31	Thick Doors - Extended Lip Required - Specify Length C to E	
	- Cylinders - IMPORTANT- See catalog 7800/8200 option page for cylinder limitations	
	- Below charges DO NOT include additional charges for special cylinder requirements	
	Doors up to 2-1/2" thick - lock centered	No addition
	Doors 2-5/8" to 6" thick OR doors 1-3/4" thick w/max 1" paneling one side.	
	For example: Specify 1-3/4" door with panel (Side) on inside or outside	
	Non Keyed function \$50.00 Keyed function \$100.00	
60	SARGENT Large Format Interchangeable Plastic Disposable Construction Core	No addition
63	SARGENT Large Format Interchangeable core cylinder, includes master keying charges	\$83.00 / cyl.
64	SARGENT Large Format Interchangeable Construction Core Cylinder	\$83.00
6573▲†	Small Format 6-Pin Uncombined Core (Refer to CK-12)	\$65.00 / cyl.
65737P▲†	Small Format 7-Pin Uncombined Core (Refer to CK-12)	\$65.00 / cyl.
68	8200 Line furnished with lever handle outside x knob inside (Excludes SLD Detention Knob)	Defaults to 8200 Lever Lock Price
69	8200 Line furnished with lever handle inside x knob outside (Excludes SLD Detention Knob)	Defaults to 8200 Lever Lock Price
70▲†	Small Format Interchangeable disposable plastic construction core	No addition
72▲†	Small Format Interchangeable 6-pin construction core (7-pin with 11 option)	\$75.00
73▲†	Small Format interchangeable core 6-pin Includes MK and GMK keying charges	\$75.00 / cyl
737P▲†	Small Format interchangeable core 7-pin (refer to CK-12 for available keyways) Includes MK and GMK keying charges	\$75.00 / cyl
81▲†	Cylinder to accept Keso (83) and Keso F1 (F183) removable core – no core provided	No addition
F182†	SARGENT Keso Security Cylinder – patented – new key systems	\$91.00 / cyl.
F183▲†	SARGENT Keso Security Removable Core Cylinder – patented – new key systems	\$130.00 / cyl.
82†	SARGENT Keso Security Cylinder (For existing systems only)	\$91.00 / cyl.
83▲†	SARGENT Keso Security Removable Core Cylinder (For existing systems only)	\$130.00 / cyl.
84▲†	SARGENT Keso Security Removable Construction Core Cylinder	See CK-18
85	Tactile Warning - Abrasive coating on inside lever	\$49.00
86	Tactile Warning - Abrasive coating on outside lever	\$49.00
87	Tactile Warning - Abrasive coating on both levers	\$98.00
AV	Anti Vandal Pull Trim (available in 32D finish), (Not available with 8270, 8271, 8272, 8273 functions)	\$229.00
BR	SARGENT Bump Resistant Cylinders (N/A w/10, 22, 30, 60, 63, 64, 70, 72, 73, 737P, KESO, SC, & SE options)	\$25.00 /cyl.
DG1	Patented Degree DG1 Key System	No addition
DG160	Hardware prepared for DG1-6300 Lg. Format IC cores, supplied with temporary plastic construction cores	No addition
DG163	Patented Degree DG1 Large Format Interchangeable Core Cylinder - Includes master keying charges	\$83.00
DG164	Hardware prepared for DG1-6300 Lg. Format IC cores, supplied with temporary keyed construction cores	\$83.00
DG2	Patented Degree DG2 Key System incorporating a locking sidebar	\$63.00/cyl.
DG260	Hardware prepared for DG2-6300 Lg. Format IC cores, supplied with temporary plastic construction cores	No addition
DG263	Patented Degree DG2 Large Format Interchangeable Core Cylinder - Includes master keying charges	\$146.00
DG264	Hardware prepared for DG2-6300 Lg. Format IC cores, supplied with temporary keyed construction cores	\$83.00
DG3	Patented Degree DG3 Key System incorporating a locking sidebar and UL437 listed	\$89.00/cyl.
DG360	Hardware prepared for DG3-6300 Lg. Format IC cores, supplied with temporary plastic construction cores	No addition
DG363	Patented Degree DG3 Large Format Interchangeable Core Cylinder - Includes master keying charges	\$172.00
DG364	Hardware prepared for DG3-6300 Lg. Format IC cores, supplied with temporary keyed construction cores	\$83.00
IDP	Integrated Door Position Switch	\$108.00
LB	Extra large thumbturn	\$18.00
LC	Less Cylinder	-\$96.00/cyl.
OBS	Open Back Strike	\$79.00
PHR	Deadbolt Privacy Function (available w/deadbolt function only)	\$100.00
R01	Mercury and Lenel compatible 1KΩ/2KΩ resistance supervision	\$100.00
R03	Software House compatible 1KΩ/2KΩ resistance supervision	\$100.00
R04	AMAG compatible 4-state supervision	\$100.00
SC▲†	Schlage "C" Keyway cylinder, (Number 41 Cylinder Only, 0 bitted)	No addition
SE▲†	Schlage "E" Keyway cylinder, (Number 41 Cylinder Only, 0 bitted)	No addition
SG	MicroShield® – an antimicrobial powder coat finish	\$73.00
WBS	Wrought Box Strike	No addition

NOTES: ▲ Options not avail. with a standard 50 function lockout cylinder. † Not avail. with 60, 63, 64 options

CPC	Clear Powder Coat over 26D/32D – NAC-82280-24V x CEMD x RH x 32D x CPC All orders will continue to be handled as a "special" when CPC is ordered.	\$67.00
-----	--	---------

Experience a safer
and more open world

Rose Design:

- CO (2-3/4")
- CR (2-3/16")
- LN (2")
- O (2-3/4")
- TO (2-3/4")
- TR (2-3/16")
- E2 (2-11/16")
- E3 (2-1/16")
- E4 (3-1/3")

Lever Design:

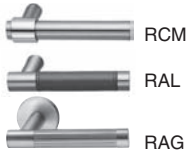

How to order Gramercy Series Levers:

Option: NAC x Function: 82280-24V x Rose: TO x Lever: RAL x Finish: 29BK29 x Hand: RH
See below for available finishes:

Lever Design Available Finishes

- RCM 2929, 3030, 2930*, 3E3E, BSBS, WSWWS
- RAL 29BK29, 29BN29, 30BK30, or 30BN30, 3EBK3E, 3EBN3E, BSBKBS, BSNBNS, WSBKWS, WSNBWS
- RAG 2929 or 3030

*Two-tone - grip of lever is 32D, balance of lever is 32. Rose/escutcheon and lock finish will be 32. See catalog for finish description.

NAC 8200 Electrified Mortise Locks with High Security Monitoring				10BE/BSP/WSP/629/630
Option	Function	Trim - Proximity Entry	Description	
NAC	82270-12V/-24V	Rose x Lever Design	Fail Safe w/Cylinder Override	\$1,669.00
NAC	82271-12V/-24V	Rose x Lever Design	Fail Secure w/Cylinder Override	
NAC	82280-12V/-24V	Rose x Lever Design	Fail Safe w/Deadbolt w/Cyl.Override	\$1,744.00
NAC	82281-12V/-24V	Rose x Lever Design	Fail Secure w/D.bolt w/Cyl.Override	
NAC	82274-12V/-24V	Rose x Lever Design	Fail Safe - No Cylinder	\$1,614.00
NAC	82275-12V/-24V	Rose x Lever Design	Fail Secure - No Cylinder	
NAC	82284-12V/-24V	Rose x Lever Design	Fail Safe w/Deadbolt - No Cylinder	\$1,689.00
NAC	82285-12V/-24V	Rose x Lever Design	Fail Secure w/Deadbolt - No Cylinder	

Note: Consult catalog for ordering information.

Specify hand and voltage (12v or 24v) when ordering

ML-68 MORTISE LOCKS

For V Series
Indicators
Click / See
Page ML-1A

SARGENT®

ASSA ABLOY

OPTIONS

USA & Canada Prices Effective May 1, 2021

Options	Description	Price
1▲	8200 Line with 1-1/16" wide front for 1-3/8" doors.	\$62.00
3	Stainless steel hub (not available with 8289, 8291 & 8292 functions)	\$69.00
10▲	SARGENT Signature Key System	\$63.00 / cyl.
11†▲	SARGENT XC Key System (not available with 10, 22, SC, SE options)	No addition
1160	SARGENT XC Large Format Interchangeable Plastic Disposable Construction Core	No addition
1163	SARGENT XC Large Format Interchangeable Core Cylinder - Includes masterkeying charges	\$83.00
1164	SARGENT XC Large Format Interchangeable Construction Core Cylinder	\$83.00
1170	Small Format interchangeable disposable construction core - to accept 7 Pin XC permanent core	No addition
11727P	Small Format interchangeable keyed construction core - to accept 7 Pin XC permanent core	\$75.00
11737P	Small Format interchangeable core - to accept 7 pin XC permanent core	\$75.00 / cyl.
21▲†	SARGENT Construction Key System (lost ball) Standard on all new systems established since 5/1/96	\$16.00 / cyl.
22▲†	SARGENT Construction Key System (split key) To be used on pre-established split key systems only	\$32.00 / cyl.
23	Locksets with flat 4 7/8" ANSI strike	No addition
31	Thick Doors - Extended Lip Required - Specify Length C to E - Cylinders - IMPORTANT- See catalog 7800/8200 option page for cylinder limitations - Below charges DO NOT include additional charges for special cylinder requirements Doors up to 2-1/2" thick - lock centered Doors 2-5/8" to 6" thick OR doors 1-3/4" thick w/max 1" paneling one side. For example: Specify 1-3/4" door with panel (Side) on inside or outside	No addition Non Keyed function \$50.00 Keyed function \$100.00
60	SARGENT Large Format Interchangeable Plastic Disposable Construction Core	No addition
63	SARGENT Large Format Interchangeable core cylinder, includes master keying charges	\$83.00 / cyl.
64	SARGENT Large Format Interchangeable Construction Core Cylinder	\$83.00
6573▲†	Small Format 6-Pin Uncombined Core (Refer to CK-12)	\$65.00 / cyl.
65737P▲†	Small Format 7-Pin Uncombined Core (Refer to CK-12)	\$65.00 / cyl.
68	8200 Line furnished with lever handle outside x knob inside (Excludes SLD Detention Knob)	Defaults to 8200 Lever Lock Price
69	8200 Line furnished with lever handle inside x knob outside (Excludes SLD Detention Knob)	Defaults to 8200 Lever Lock Price
70▲†	Small Format Interchangeable disposable plastic construction core	No addition
72▲†	Small Format Interchangeable 6-pin construction core (7-pin with 11 option)	\$75.00
73▲†	Small Format interchangeable core 6-pin Includes MK and GMK keying charges	\$75.00 / cyl
737P▲†	Small Format interchangeable core 7-pin (refer to CK-12 for available keyways) Includes MK and GMK keying charges	\$75.00 / cyl
81▲†	Cylinder to accept Keso (83) and Keso F1 (F183) removable core – no core provided	No addition
F182†	SARGENT Keso Security Cylinder – patented – new key systems	\$91.00 / cyl.
F183▲†	SARGENT Keso Security Removable Core Cylinder – patented – new key systems	\$130.00 / cyl.
82†	SARGENT Keso Security Cylinder (For existing systems only)	\$91.00 / cyl.
83▲†	SARGENT Keso Security Removable Core Cylinder (For existing systems only)	\$130.00 / cyl.
84▲†	SARGENT Keso Security Removable Construction Core Cylinder	See CK-18
AV	Anti Vandal Pull Trim (available in 32D finish), (Not available with 8270, 8271, 8272, 8273 functions)	\$229.00
BR	SARGENT Bump Resistant Cylinders (N/A w/10, 22, 30, 60, 63, 64, 70, 72, 73, 737P, KESO, SC, & SE options)	\$25.00 /cyl.
DG1	Patented Degree DG1 Key System	No addition
DG160	Hardware prepared for DG1-6300 Lg. Format IC cores, supplied with temporary plastic construction cores	No addition
DG163	Patented Degree DG1 Large Format Interchangeable Core Cylinder - Includes master keying charges	\$83.00
DG164	Hardware prepared for DG1-6300 Lg. Format IC cores, supplied with temporary keyed construction cores	\$83.00
DG2	Patented Degree DG2 Key System incorporating a locking sidebar	\$63.00/cyl.
DG260	Hardware prepared for DG2-6300 Lg. Format IC cores, supplied with temporary plastic construction cores	No addition
DG263	Patented Degree DG2 Large Format Interchangeable Core Cylinder - Includes master keying charges	\$146.00
DG264	Hardware prepared for DG2-6300 Lg. Format IC cores, supplied with temporary keyed construction cores	\$83.00
DG3	Patented Degree DG3 Key System incorporating a locking sidebar and UL437 listed	\$89.00/cyl.
DG360	Hardware prepared for DG3-6300 Lg. Format IC cores, supplied with temporary plastic construction cores	No addition
DG363	Patented Degree DG3 Large Format Interchangeable Core Cylinder - Includes master keying charges	\$172.00
DG364	Hardware prepared for DG3-6300 Lg. Format IC cores, supplied with temporary keyed construction cores	\$83.00
DX	Deadbolt Monitoring (not available with 50, 74)	\$197.00
LB	Extra large thumbturn	\$18.00
LC	Less Cylinder	-\$96.00/cyl.
LX	Latchbolt Monitor – available with all non-deadbolt functions; not available with DX option	\$200.00
OBS	Open Back Strike	\$79.00
RX	Request to Exit	\$206.00
SC▲†	Schlage "C" Keyway cylinder, (Number 41 Cylinder Only, 0 bitted)	No addition
SE▲†	Schlage "E" Keyway cylinder, (Number 41 Cylinder Only, 0 bitted)	No addition
SG	MicroShield® – an antimicrobial powder coat finish (Not available with RAS lever)	\$73.00
WBS	Wrought Box Strike	No addition
NOTES: ▲ Options not avail. with a standard 50 function lockout cylinder. † Not avail. with 60, 63, 64 options		
CPC	Clear Powder Coat over 26D/32D – 8205 x CEREM x RH x 32D x CPC All orders will continue to be handled as a "special" when CPC is ordered.	\$67.00

Experience a safer
and more open world

Copyright © 2002-2021 Sargent Manufacturing Company, an ASSA ABLOY Group company. All rights reserved.
Reproduction in whole or in part without the express written permission of Sargent Manufacturing Company is prohibited.
Contact us at: 800-727-5477 or visit www.sargentlock.com. In Canada contact us at: 800-461-3007 or visit www.assaabloydss.ca

ASSA ABLOY

8200 STUDIO COLLECTION - GRAMERCY SERIES

USA & Canada Prices Effective May 1, 2021

Esc. Design:

CE
TE
LE1*
VN1^

Lever Design:

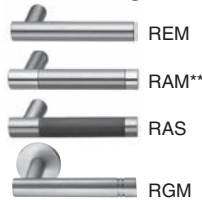

How to order Gramercy Series Levers:

Option: 10 x Function: 8204 x Esc.: CE x Lever: REM x Finish: 2930 x Hand: RH

See below for available finishes:

Lever Design Available Finishes

REM-RGM 2929, 3030, 3E3E, BSBS, WSWWS

RAM 2930*

RAS 29BK29, 30BK30, 3E3E, BSBS, WSWWS

*Two-tone - grip of lever is 32D, balance of lever is 32. Rose/escutcheon and lock finish will be 32.

See catalog for finish description.

**RAM is not available in 10BE/BSP/WSP finish.

Function – Single Cylinder		Finish – 10BE/BSP/WSP/629/630
8204	Storeroom or Closet	
8205	Office or Entry	\$1,314.00
8237	Classroom	
8255	Office or Entry	
8206	Storeroom or Service	
8231	Utility	
8236	Closet	
8256	Office or Inner Entry	\$1,338.00
8257, 8258, 8267	Institutional Privacy	
8289	Holdback	
8291	All Purpose Holdback	
Single Cylinder With Deadbolt		
8224	Room Door	
8225	Dormitory or Exit	
8227	Closet or Storeroom	
8228, 8230	Dummy Trim Deadlock	
8235	Storeroom	\$1,368.00
8243	Apartment Corridor	
8245	Dormitory or Exit	
8247	Front Door or Apartment Corridor	
8251	Storeroom Deadbolt	
8250	Hotel Guest Lock	\$1,401.00
Double Cylinder No Deadbolt		
8216	Apartment or Exit or Public Toilet	
8217	Asylum or Institutional	
8238	Classroom Security Intruder	\$1,421.00
8242	Classroom Security Intruder Latchbolt	
8259	School Security	
8290	Classroom Security Holdback	
8292	All Purpose Holdback	
Double Cylinder With Deadbolt		
8226	Store Door	
8229	Dummy Trim Deadlock	
8239, 8240	Classroom Security Intruder	
8241	Classroom Security	\$1,444.00
8246	Dormitory or Exit	
8248	Store Door	
8249	Security	
8252	Institutional	
Electro Mechanical Single Cylinder – Specify 12V or 24V		
8270-12V / 8270-24V	Fail Safe	\$1,510.00
8271-12V / 8271-24V	Fail Secure	
Electro Mechanical Double Cylinder – Specify 12V or 24V		
8272-12V / 8272-24V	Fail Safe	\$1,567.00
8273-12V / 8273-24V	Fail Secure	
Non Keyed		
8213	Communication or Exit	\$1,150.00
8215	Passage or Closet	
8265	Privacy Bedroom or Bath (Latch)	\$1,256.00
8266, 8268	Privacy Bedroom or Bath (Deadbolt)	\$1,292.00
8293*	Single Dummy Trim	\$482.00
8294	Double Dummy Trim	\$965.00
8295	Single Dummy Trim w/Lockbody	\$579.00
8296	Double Dummy Trim w/Lockbody	\$1,066.00
8297	Double Dummy w/Active Trim	\$1,150.00

ML-70 MORTISE LOCKS

For V Series
Indicators
Click / See
Page ML-1A

SARGENT®

ASSA ABLOY

OPTIONS USA & Canada Prices Effective May 1, 2021

Options	Description	Price
1▲	8200 Line with 1-1/16" wide front for 1-3/8" doors.	\$62.00
3	Stainless steel hub (not available with 8289, 8291 & 8292 functions)	\$69.00
10▲	SARGENT Signature Key System	\$63.00 / cyl.
11†▲	SARGENT XC Key System (not available with 10, 22, SC, SE options)	No addition
1160	SARGENT XC Large Format Interchangeable Plastic Disposable Construction Core	No addition
1163	SARGENT XC Large Format Interchangeable Core Cylinder - Includes masterkeying charges	\$83.00
1164	SARGENT XC Large Format Interchangeable Construction Core Cylinder	\$83.00
1170	Small Format interchangeable disposable construction core - to accept 7 Pin XC permanent core	No addition
11727P	Small Format interchangeable keyed construction core - to accept 7 Pin XC permanent core	\$75.00
11737P	Small Format interchangeable core - to accept 7 pin XC permanent core	\$75.00 / cyl.
21▲†	SARGENT Construction Key System (lost ball) Standard on all new systems established since 5/1/96	\$16.00 / cyl.
22▲†	SARGENT Construction Key System (split key) To be used on pre-established split key systems only	\$32.00 / cyl.
23	Locksets with flat 4 7/8" ANSI strike	No addition
31	Thick Doors - Extended Lip Required - Specify Length C to E - Cylinders - IMPORTANT- See catalog 7800/8200 option page for cylinder limitations - Below charges DO NOT include additional charges for special cylinder requirements Doors up to 2-1/2" thick - lock centered Doors 2-5/8" to 6" thick OR doors 1-3/4" thick w/max 1" paneling one side. For example: Specify 1-3/4" door with panel (Side) on inside or outside	No addition
	Non Keyed function \$50.00 Keyed function \$100.00	
60	SARGENT Large Format Interchangeable Plastic Disposable Construction Core	No addition
63	SARGENT Large Format Interchangeable core cylinder, includes master keying charges	\$83.00 / cyl.
64	SARGENT Large Format Interchangeable Construction Core Cylinder	\$83.00
6573▲†	Small Format 6-Pin Uncombined Core (Refer to CK-12)	\$65.00 / cyl.
65737P▲†	Small Format 7-Pin Uncombined Core (Refer to CK-12)	\$65.00 / cyl.
68	8200 Line furnished with lever handle outside x knob inside (Excludes SLD Detention Knob)	Defaults to 8200 Lever Lock Price
69	8200 Line furnished with lever handle inside x knob outside (Excludes SLD Detention Knob)	Defaults to 8200 Lever Lock Price
70▲†	Small Format Interchangeable disposable plastic construction core	No addition
72▲†	Small Format Interchangeable 6-pin construction core (7-pin with 11 option)	\$75.00
73▲†	Small Format interchangeable core 6-pin Includes MK and GMK keying charges	\$75.00 / cyl
737P▲†	Small Format interchangeable core 7-pin (refer to CK-12 for available keyways) Includes MK and GMK keying charges	\$75.00 / cyl
81▲†	Cylinder to accept Keso (83) and Keso F1 (F183) removable core – no core provided	No addition
F182†	SARGENT Keso Security Cylinder – patented – new key systems	\$91.00 / cyl.
F183▲†	SARGENT Keso Security Removable Core Cylinder – patented – new key systems	\$130.00 / cyl.
82†	SARGENT Keso Security Cylinder (For existing systems only)	\$91.00 / cyl.
83▲†	SARGENT Keso Security Removable Core Cylinder (For existing systems only)	\$130.00 / cyl.
84▲†	SARGENT Keso Security Removable Construction Core Cylinder	See CK-18
85	Tactile Warning - Abrasive coating on inside lever	\$49.00
86	Tactile Warning - Abrasive coating on outside lever	\$49.00
87	Tactile Warning - Abrasive coating on both levers	\$98.00
AV	Anti Vandal Pull Trim (available in 32D finish), (Not available with 8270, 8271, 8272, 8273 functions)	\$229.00
BR	SARGENT Bump Resistant Cylinders (N/A w/10, 22, 30, 60, 63, 64, 70, 72, 73, 737P, KESO, SC, & SE options)	\$25.00 / cyl.
DG1	Patented Degree DG1 Key System	No addition
DG160	Hardware prepared for DG1-6300 Lg. Format IC cores, supplied with temporary plastic construction cores	No addition
DG163	Patented Degree DG1 Large Format Interchangeable Core Cylinder - Includes master keying charges	\$83.00
DG164	Hardware prepared for DG1-6300 Lg. Format IC cores, supplied with temporary keyed construction cores	\$83.00
DG2	Patented Degree DG2 Key System incorporating a locking sidebar	\$63.00/cyl.
DG260	Hardware prepared for DG2-6300 Lg. Format IC cores, supplied with temporary plastic construction cores	No addition
DG263	Patented Degree DG2 Large Format Interchangeable Core Cylinder - Includes master keying charges	\$146.00
DG264	Hardware prepared for DG2-6300 Lg. Format IC cores, supplied with temporary keyed construction cores	\$83.00
DG3	Patented Degree DG3 Key System incorporating a locking sidebar and UL437 listed	\$89.00/cyl.
DG360	Hardware prepared for DG3-6300 Lg. Format IC cores, supplied with temporary plastic construction cores	No addition
DG363	Patented Degree DG3 Large Format Interchangeable Core Cylinder - Includes master keying charges	\$172.00
DG364	Hardware prepared for DG3-6300 Lg. Format IC cores, supplied with temporary keyed construction cores	\$83.00
IDP	Integrated Door Position Switch	\$108.00
LB	Extra large thumbturn	\$18.00
LC	Less Cylinder	-\$96.00/cyl.
OBS	Open Back Strike	\$79.00
PHR	Deadbolt Privacy Function (available w/deadbolt function only)	\$100.00
R01	Mercury and Lenel compatible 1KΩ/2KΩ resistance supervision	\$100.00
R03	Software House compatible 1KΩ/2KΩ resistance supervision	\$100.00
R04	AMAG compatible 4-state supervision	\$100.00
SC▲†	Schlage "C" Keyway cylinder, (Number 41 Cylinder Only, 0 bitting)	No addition
SE▲†	Schlage "E" Keyway cylinder, (Number 41 Cylinder Only, 0 bitting)	No addition
SG	MicroShield® – an antimicrobial powder coat finish	\$73.00
WBS	Wrought Box Strike	No addition
NOTES: ▲ Options not avail. with a standard 50 function lockout cylinder. † Not avail. with 60, 63, 64 options		
CPC	Clear Powder Coat over 26D/32D – NAC-82280-24V x CEMD x RH x 32D x CPC All orders will continue to be handled as a "special" when CPC is ordered.	\$67.00

Experience a safer
and more open world

Copyright © 2002-2021 Sargent Manufacturing Company, an ASSA ABLOY Group company. All rights reserved.
Reproduction in whole or in part without the express written permission of Sargent Manufacturing Company is prohibited.
Contact us at: 800-727-5477 or visit www.sargentlock.com. In Canada contact us at: 800-461-3007 or visit www.assaabloydss.ca

Esc. Design:

CE
TE
LE1
VN1^

Lever Design:

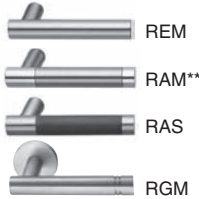

How to order Gramercy Series Levers:

Option: NAC x Function: 82280-24V x Esc.: CE x Lever: REM x Finish: 2930 x Hand: RH

See below for available finishes:

Lever Design Available Finishes

REM-RGM 2929, 3030, 3E3E, BSBS, WSWWS

RAM 2930*

RAS 29BK29, 30BK30, 3E3E, BSBS, WSWWS

*Two-tone - grip of lever is 32D, balance of lever is 32. Rose/escutcheon and lock finish will be 32.

See catalog for finish description.

**RAM is not available in 10BE/BSP/WSP finish.

NAC 8200 Electrified Mortise Locks with High Security Monitoring				10BE/BSP/WSP/ 629/630
Option	Function	Trim - Proximity Entry	Description	
NAC	82270-12V/-24V	Rose x Lever Design	Fail Safe w/Cylinder Override	\$1,685.00
NAC	82271-12V/-24V	Rose x Lever Design	Fail Secure w/Cylinder Override	
NAC	82280-12V/-24V	Rose x Lever Design	Fail Safe w/Deadbolt w/Cyl.Override	\$1,760.00
NAC	82281-12V/-24V	Rose x Lever Design	Fail Secure w/D.bolt w/Cyl.Override	
NAC	82274-12V/-24V	Rose x Lever Design	Fail Safe - No Cylinder	\$1,630.00
NAC	82275-12V/-24V	Rose x Lever Design	Fail Secure - No Cylinder	
NAC	82284-12V/-24V	Rose x Lever Design	Fail Safe w/Deadbolt - No Cylinder	\$1,705.00
NAC	82285-12V/-24V	Rose x Lever Design	Fail Secure w/Deadbolt - No Cylinder	

Note: Consult catalog for ordering information.

Specify hand and voltage (12v or 24v) when ordering

ML-72 MORTISE LOCKS

For V Series
Indicators
Click / See
Page ML-1A

SARGENT®

ASSA ABLOY

OPTIONS

USA & Canada Prices Effective May 1, 2021

Options	Description	Price
1▲	8200 Line with 1-1/16" wide front for 1-3/8" doors.	\$62.00
3	Stainless steel hub (not available with 8289, 8291 & 8292 functions)	\$69.00
10▲	SARGENT Signature Key System	\$63.00 / cyl.
11†▲	SARGENT XC Key System (not available with 10, 22, SC, SE options)	No addition
1160	SARGENT XC Large Format Interchangeable Plastic Disposable Construction Core	No addition
1163	SARGENT XC Large Format Interchangeable Core Cylinder - Includes masterkeying charges	\$83.00
1164	SARGENT XC Large Format Interchangeable Construction Core Cylinder	\$83.00
1170	Small Format interchangeable disposable construction core - to accept 7 Pin XC permanent core	No addition
11727P	Small Format interchangeable keyed construction core - to accept 7 Pin XC permanent core	\$75.00
11737P	Small Format interchangeable core - to accept 7 pin XC permanent core	\$75.00 / cyl.
21▲†	SARGENT Construction Key System (lost ball) Standard on all new systems established since 5/1/96	\$16.00 / cyl.
22▲†	SARGENT Construction Key System (split key) To be used on pre-established split key systems only	\$32.00 / cyl.
23	Locksets with flat 4 7/8" ANSI strike	No addition
31	Thick Doors - Extended Lip Required - Specify Length C to E - Cylinders - IMPORTANT- See catalog 7800/8200 option page for cylinder limitations - Below charges DO NOT include additional charges for special cylinder requirements Doors up to 2-1/2" thick - lock centered Doors 2-5/8" to 6" thick OR doors 1-3/4" thick w/max 1" paneling one side. For example: Specify 1-3/4" door with panel (Side) on inside or outside	No addition Non Keyed function \$50.00 Keyed function \$100.00
60	SARGENT Large Format Interchangeable Plastic Disposable Construction Core	No addition
63	SARGENT Large Format Interchangeable core cylinder, includes master keying charges	\$83.00 / cyl.
64	SARGENT Large Format Interchangeable Construction Core Cylinder	\$83.00
6573▲†	Small Format 6-Pin Uncombined Core (Refer to CK-12)	\$65.00 / cyl.
65737P▲†	Small Format 7-Pin Uncombined Core (Refer to CK-12)	\$65.00 / cyl.
68	8200 Line furnished with lever handle outside x knob inside (Excludes SLD Detention Knob)	Defaults to 8200 Lever Lock Price
69	8200 Line furnished with lever handle inside x knob outside (Excludes SLD Detention Knob)	Defaults to 8200 Lever Lock Price
70▲†	Small Format Interchangeable disposable plastic construction core	No addition
72▲†	Small Format interchangeable 6-pin construction core (7-pin with 11 option)	\$75.00
73▲†	Small Format interchangeable core 6-pin Includes MK and GMK keying charges	\$75.00 / cyl
737P▲†	Small Format interchangeable core 7-pin (refer to CK-12 for available keyways) Includes MK and GMK keying charges	\$75.00 / cyl
81▲†	Cylinder to accept Keso (83) and Keso F1 (F183) removable core – no core provided	No addition
F182†	SARGENT Keso Security Cylinder – patented – new key systems	\$91.00 / cyl.
F183▲†	SARGENT Keso Security Removable Core Cylinder – patented – new key systems	\$130.00 / cyl.
82†	SARGENT Keso Security Cylinder (For existing systems only)	\$91.00 / cyl.
83▲†	SARGENT Keso Security Removable Core Cylinder (For existing systems only)	\$130.00 / cyl.
84▲†	SARGENT Keso Security Removable Construction Core Cylinder	See CK-18
AV	Anti Vandal Pull Trim (available in 32D finish), (Not available with 8270, 8271, 8272, 8273 functions)	\$229.00
BR	SARGENT Bump Resistant Cylinders (N/A w/10, 22, 30, 60, 63, 64, 70, 72, 73, 737P, KESO, SC, & SE options)	\$25.00 / cyl.
DG1	Patented Degree DG1 Key System	No addition
DG160	Hardware prepared for DG1-6300 Lg. Format IC cores, supplied with temporary plastic construction cores	No addition
DG163	Patented Degree DG1 Large Format Interchangeable Core Cylinder - Includes master keying charges	\$83.00
DG164	Hardware prepared for DG1-6300 Lg. Format IC cores, supplied with temporary keyed construction cores	\$83.00
DG2	Patented Degree DG2 Key System incorporating a locking sidebar	\$63.00/cyl.
DG260	Hardware prepared for DG2-6300 Lg. Format IC cores, supplied with temporary plastic construction cores	No addition
DG263	Patented Degree DG2 Large Format Interchangeable Core Cylinder - Includes master keying charges	\$146.00
DG264	Hardware prepared for DG2-6300 Lg. Format IC cores, supplied with temporary keyed construction cores	\$83.00
DG3	Patented Degree DG3 Key System incorporating a locking sidebar and UL437 listed	\$89.00/cyl.
DG360	Hardware prepared for DG3-6300 Lg. Format IC cores, supplied with temporary plastic construction cores	No addition
DG363	Patented Degree DG3 Large Format Interchangeable Core Cylinder - Includes master keying charges	\$172.00
DG364	Hardware prepared for DG3-6300 Lg. Format IC cores, supplied with temporary keyed construction cores	\$83.00
DX	Deadbolt Monitoring (not available with 50, 74)	\$197.00
LB	Extra large thumbturn	\$18.00
LC	Less Cylinder	-\$96.00/cyl.
LX	Latchbolt Monitor – available with all non-deadbolt functions; not available with DX option	\$200.00
OBS	Open Back Strike	\$79.00
RX	Request to Exit	\$206.00
SC▲†	Schlage "C" Keyway cylinder, (Number 41 Cylinder Only, 0 bitted)	No addition
SE▲†	Schlage "E" Keyway cylinder, (Number 41 Cylinder Only, 0 bitted)	No addition
SG	MicroShield® – an antimicrobial powder coat finish (Not available with RAL levers)	\$73.00
WBS	Wrought Box Strike	No addition

NOTES: ▲ Options not avail. with a standard 50 function lockout cylinder. † Not avail. with 60, 63, 64 options

CPC	Clear Powder Coat over 26D/32D – 8205 x CERAG x RH x 32D x CPC All orders will continue to be handled as a "special" when CPC is ordered.	\$67.00
-----	--	---------

Experience a safer
and more open world

Copyright © 2002-2021 Sargent Manufacturing Company, an ASSA ABLOY Group company. All rights reserved.
Reproduction in whole or in part without the express written permission of Sargent Manufacturing Company is prohibited.
Contact us at: 800-727-5477 or visit www.sargentlock.com. In Canada contact us at: 800-461-3007 or visit www.assaabloydss.ca

ASSA ABLOY

8200 STUDIO COLLECTION - GRAMERCY SERIES

USA & Canada Prices Effective May 1, 2021

Esc. Design:

CE
TE
LE1
VN1^

Lever Design:

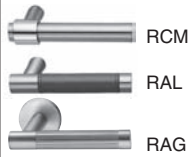

How to order Gramercy Series Levers:

Option: 60 x Function: 8204 x Esc.: LE1 x Lever: RCM x Finish: 2929 x Hand: RH
See below for available finishes:

Lever Design Available Finishes

RCM 2929, 3030, 2930*, 3E3E, BSBS, WSWWS
RAL 29BK29, 29BN29, 30BK30, or 30BN30, 3EBK3E, 3EBN3E, BSBKBS, BSBNBS, WSBKWS, WSBNWS
RAG 2929 or 3030

*Two-tone - grip of lever is 32D, balance of lever is 32. Rose/escutcheon and lock finish will be 32. See catalog for finish description.

Function – Single Cylinder		Finish – 10BE/BSP/WSP/629/630
8204	Storeroom or Closet	
8205	Office or Entry	\$1,397.00
8237	Classroom	
8255	Office or Entry	
8206	Storeroom or Service	
8231	Utility	
8236	Closet	
8256	Office or Inner Entry	\$1,420.00
8257, 8258, 8267	Institutional Privacy	
8289	Holdback	
8291	All Purpose Holdback	
Single Cylinder With Deadbolt		
8224	Room Door	
8225	Dormitory or Exit	
8227	Closet or Storeroom	
8228, 8230	Dummy Trim Deadlock	
8235	Storeroom	\$1,450.00
8243	Apartment Corridor	
8245	Dormitory or Exit	
8247	Front Door or Apartment Corridor	
8251	Storeroom Deadbolt	
8250	Hotel Guest Lock	\$1,481.00
Double Cylinder No Deadbolt		
8216	Apartment or Exit or Public Toilet	
8217	Asylum or Institutional	
8238	Classroom Security Intruder	\$1,502.00
8242	Classroom Security Intruder Latchbolt	
8259	School Security	
8290	Classroom Security Holdback	
8292	All Purpose Holdback	
Double Cylinder With Deadbolt		
8226	Store Door	
8229	Dummy Trim Deadlock	
8239, 8240	Classroom Security Intruder	
8241	Classroom Security	\$1,523.00
8246	Dormitory or Exit	
8248	Store Door	
8249	Security	
8252	Institutional	
Electro Mechanical Single Cylinder – Specify 12V or 24V		
8270-12V / 8270-24V	Fail Safe	\$1,593.00
8271-12V / 8271-24V	Fail Secure	
Electro Mechanical Double Cylinder – Specify 12V or 24V		
8272-12V / 8272-24V	Fail Safe	\$1,650.00
8273-12V / 8273-24V	Fail Secure	
Non Keyed		
8213	Communication or Exit	\$1,229.00
8215	Passage or Closet	
8265	Privacy Bedroom or Bath (Latch)	\$1,338.00
8266, 8268	Privacy Bedroom or Bath (Deadbolt)	\$1,373.00
8293*	Single Dummy Trim	\$562.00
8294	Double Dummy Trim	\$1,045.00
8295	Single Dummy Trim w/Lockbody	\$659.00
8296	Double Dummy Trim w/Lockbody	\$1,144.00
8297	Double Dummy w/Active Trim	\$1,229.00

ML-74 MORTISE LOCKS

For V Series
Indicators
Click / See
Page ML-1A

SARGENT®

ASSA ABLOY

OPTIONS USA & Canada Prices Effective May 1, 2021

Options	Description	Price
1▲	8200 Line with 1-1/16" wide front for 1-3/8" doors.	\$62.00
3	Stainless steel hub (not available with 8289, 8291 & 8292 functions)	\$69.00
10▲	SARGENT Signature Key System	\$63.00 / cyl.
11†▲	SARGENT XC Key System (not available with 10, 22, SC, SE options)	No addition
1160	SARGENT XC Large Format Interchangeable Plastic Disposable Construction Core	No addition
1163	SARGENT XC Large Format Interchangeable Core Cylinder - Includes masterkeying charges	\$83.00
1164	SARGENT XC Large Format Interchangeable Construction Core Cylinder	\$83.00
1170	Small Format interchangeable disposable construction core - to accept 7 Pin XC permanent core	No addition
11727P	Small Format interchangeable keyed construction core - to accept 7 Pin XC permanent core	\$75.00
11737P	Small Format interchangeable core - to accept 7 pin XC permanent core	\$75.00 / cyl.
21▲†	SARGENT Construction Key System (lost ball) Standard on all new systems established since 5/1/96	\$16.00 / cyl.
22▲†	SARGENT Construction Key System (split key) To be used on pre-established split key systems only	\$32.00 / cyl.
23	Locksets with flat 4 7/8" ANSI strike	No addition
31	Thick Doors - Extended Lip Required - Specify Length C to E - Cylinders - IMPORTANT- See catalog 7800/8200 option page for cylinder limitations - Below charges DO NOT include additional charges for special cylinder requirements Doors up to 2-1/2" thick - lock centered Doors 2-5/8" to 6" thick OR doors 1-3/4" thick w/max 1" paneling one side. For example: Specify 1-3/4" door with panel (Side) on inside or outside	No addition
	Non Keyed function \$50.00 Keyed function \$100.00	
60	SARGENT Large Format Interchangeable Plastic Disposable Construction Core	No addition
63	SARGENT Large Format Interchangeable core cylinder, includes master keying charges	\$83.00 / cyl.
64	SARGENT Large Format Interchangeable Construction Core Cylinder	\$83.00
6573▲†	Small Format 6-Pin Uncombined Core (Refer to CK-12)	\$65.00 / cyl.
65737P▲†	Small Format 7-Pin Uncombined Core (Refer to CK-12)	\$65.00 / cyl.
68	8200 Line furnished with lever handle outside x knob inside (Excludes SLD Detention Knob)	Defaults to 8200 Lever Lock Price
69	8200 Line furnished with lever handle inside x knob outside (Excludes SLD Detention Knob)	Defaults to 8200 Lever Lock Price
70▲†	Small Format Interchangeable disposable plastic construction core	No addition
72▲†	Small Format Interchangeable 6-pin construction core (7-pin with 11 option)	\$75.00
73▲†	Small Format interchangeable core 6-pin Includes MK and GMK keying charges	\$75.00 / cyl
737P▲†	Small Format interchangeable core 7-pin (refer to CK-12 for available keyways) Includes MK and GMK keying charges	\$75.00 / cyl
81▲†	Cylinder to accept Keso (83) and Keso F1 (F183) removable core – no core provided	No addition
F182†	SARGENT Keso Security Cylinder – patented – new key systems	\$91.00 / cyl.
F183▲†	SARGENT Keso Security Removable Core Cylinder – patented – new key systems	\$130.00 / cyl.
82†	SARGENT Keso Security Cylinder (For existing systems only)	\$91.00 / cyl.
83▲†	SARGENT Keso Security Removable Core Cylinder (For existing systems only)	\$130.00 / cyl.
84▲†	SARGENT Keso Security Removable Construction Core Cylinder	See CK-18
85	Tactile Warning - Abrasive coating on inside lever	\$49.00
86	Tactile Warning - Abrasive coating on outside lever	\$49.00
87	Tactile Warning - Abrasive coating on both levers	\$98.00
AV	Anti Vandal Pull Trim (available in 32D finish), (Not available with 8270, 8271, 8272, 8273 functions)	\$229.00
BR	SARGENT Bump Resistant Cylinders (N/A w/10, 22, 30, 60, 63, 64, 70, 72, 73, 737P, KESO, SC, & SE options)	\$25.00 / cyl.
DG1	Patented Degree DG1 Key System	No addition
DG160	Hardware prepared for DG1-6300 Lg. Format IC cores, supplied with temporary plastic construction cores	No addition
DG163	Patented Degree DG1 Large Format Interchangeable Core Cylinder - Includes master keying charges	\$83.00
DG164	Hardware prepared for DG1-6300 Lg. Format IC cores, supplied with temporary keyed construction cores	\$83.00
DG2	Patented Degree DG2 Key System incorporating a locking sidebar	\$63.00/cyl.
DG260	Hardware prepared for DG2-6300 Lg. Format IC cores, supplied with temporary plastic construction cores	No addition
DG263	Patented Degree DG2 Large Format Interchangeable Core Cylinder - Includes master keying charges	\$146.00
DG264	Hardware prepared for DG2-6300 Lg. Format IC cores, supplied with temporary keyed construction cores	\$83.00
DG3	Patented Degree DG3 Key System incorporating a locking sidebar and UL437 listed	\$89.00/cyl.
DG360	Hardware prepared for DG3-6300 Lg. Format IC cores, supplied with temporary plastic construction cores	No addition
DG363	Patented Degree DG3 Large Format Interchangeable Core Cylinder - Includes master keying charges	\$172.00
DG364	Hardware prepared for DG3-6300 Lg. Format IC cores, supplied with temporary keyed construction cores	\$83.00
IDP	Integrated Door Position Switch	\$108.00
LB	Extra large thumbturn	\$18.00
LC	Less Cylinder	-\$96.00/cyl.
OBS	Open Back Strike	\$79.00
PHR	Deadbolt Privacy Function (available w/deadbolt function only)	\$100.00
R01	Mercury and Lenel compatible 1KΩ/2KΩ resistance supervision	\$100.00
R03	Software House compatible 1KΩ/2KΩ resistance supervision	\$100.00
R04	AMAG compatible 4-state supervision	\$100.00
SC▲†	Schlage "C" Keyway cylinder, (Number 41 Cylinder Only, 0 bitted)	No addition
SE▲†	Schlage "E" Keyway cylinder, (Number 41 Cylinder Only, 0 bitted)	No addition
SG	MicroShield® – an antimicrobial powder coat finish	\$73.00
WBS	Wrought Box Strike	No addition
NOTES:	▲ Options not avail. with a standard 50 function lockout cylinder. † Not avail. with 60, 63, 64 options	
CPC	Clear Powder Coat over 26D/32D – NAC-82280-24V x CEMD x RH x 32D x CPC All orders will continue to be handled as a "special" when CPC is ordered.	\$67.00

Experience a safer
and more open world

Copyright © 2002-2021 Sargent Manufacturing Company, an ASSA ABLOY Group company. All rights reserved.
Reproduction in whole or in part without the express written permission of Sargent Manufacturing Company is prohibited.
Contact us at: 800-727-5477 or visit www.sargentlock.com. In Canada contact us at: 800-461-3007 or visit www.assaabloydss.ca

Esc. Design:

CE
TE
LE1
VN1^

Lever Design:

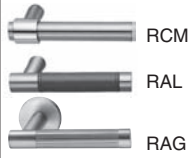

How to order Gramercy Series Levers:

Option: NAC x Function: 82271-12V x Esc.: LE1 x Lever: RCM x Finish: 2929 x Hand: RH
See below for available finishes:

Lever Design Available Finishes

RCM 2929, 3030, 2930*, 3E3E, BSBS, WSW
RAL 29BK29, 29BN29, 30BK30, or 30BN30, 3EBK3E, 3EBN3E, BSBKBS, BSNBNS,
WSBKWS, WSNBWS
RAG 2929 or 3030

*Two-tone - grip of lever is 32D, balance of lever is 32. Rose/escutcheon and lock finish will be 32. See catalog for finish description.

NAC 8200 Electrified Mortise Locks with High Security Monitoring				10BE/BSP/WSP/ 629/630
Option	Function	Trim - Proximity Entry	Description	
NAC	82270-12V/-24V	Rose x Lever Design	Fail Safe w/Cylinder Override	\$1,768.00
NAC	82271-12V/-24V	Rose x Lever Design	Fail Secure w/Cylinder Override	
NAC	82280-12V/-24V	Rose x Lever Design	Fail Safe w/Deadbolt w/Cyl.Override	\$1,843.00
NAC	82281-12V/-24V	Rose x Lever Design	Fail Secure w/D.bolt w/Cyl.Override	
NAC	82274-12V/-24V	Rose x Lever Design	Fail Safe - No Cylinder	\$1,713.00
NAC	82275-12V/-24V	Rose x Lever Design	Fail Secure - No Cylinder	
NAC	82284-12V/-24V	Rose x Lever Design	Fail Safe w/Deadbolt - No Cylinder	\$1,788.00
NAC	82285-12V/-24V	Rose x Lever Design	Fail Secure w/Deadbolt - No Cylinder	

Note: Consult catalog for ordering information.

Specify hand and voltage (12v or 24v) when ordering

ML-76 MORTISE LOCKS

For V Series
Indicators
Click / See
Page ML-1A

SARGENT®

ASSA ABLOY

OPTIONS

USA & Canada Prices Effective May 1, 2021

Options	Description	Price
10▲	SARGENT Signature Key System	\$63.00 / cyl.
11†▲	SARGENT XC Key System (not available with 10, 22, SC, SE options)	No addition
1160	SARGENT XC Large Format Interchangeable Plastic Disposable Construction Core	No addition
1163	SARGENT XC Large Format Interchangeable Core Cylinder - Includes masterkeying charges	\$83.00
1164	SARGENT XC Large Format Interchangeable Construction Core Cylinder	\$83.00
1170	Small Format interchangeable disposable construction core - to accept 7 Pin XC permanent core	No addition
11727P	Small Format interchangeable keyed construction core - to accept 7 Pin XC permanent core	\$75.00
11737P	Small Format interchangeable core - to accept 7 pin XC permanent core	\$75.00 /cyl.
21▲†	SARGENT Construction Key System (lost ball) Standard on all new systems established since 5/1/96	\$16.00 / cyl.
22▲†	SARGENT Construction Key System (split key) To be used on pre-established split key systems only	\$32.00 / cyl.
23	Locksets with flat 4 7/8" ANSI strike	No addition
31	Thick Doors - Extended Lip Required - Specify Length C to E - Cylinders - IMPORTANT- See catalog 7800/8200 option page for cylinder limitations - Below charges DO NOT include additional charges for special cylinder requirements Doors up to 2-1/2" thick - lock centered Doors 2-5/8" to 6" thick OR doors 1-3/4" thick w/max 1" paneling one side. For example: Specify 1-3/4" door with panel (Side) on inside or outside	No addition Non Keyed function \$50.00 Keyed function \$100.00
49	Visual Status Indicator (available with 26, 29, 30, 36, 37, 38, 39, 40, 41 functions) or Occupancy Indicator with Emergency Release (available with 65, 66, 68 functions)	\$140.00
60	SARGENT Large Format Interchangeable Plastic Disposable Construction Core	No addition
63	SARGENT Large Format Interchangeable core cylinder, includes master keying charges	\$83.00 / cyl.
64	SARGENT Large Format Interchangeable Construction Core Cylinder	\$83.00
6573▲†	Small Format 6-Pin Uncombined Core (Refer to CK-12)	\$65.00 / cyl.
65737P▲†	Small Format 7-Pin Uncombined Core (Refer to CK-12)	\$65.00 / cyl.
70▲†	Small Format Interchangeable disposable plastic construction core	No addition
72▲†	Small Format Interchangeable 6-pin construction core (7-pin with 11 option)	See CK-2
73▲†	Small Format interchangeable core 6-pin Includes MK and GMK keying charges	\$75.00 / cyl
737P▲†	Small Format interchangeable core 7-pin (refer to CK-12 for available keyways) Includes MK and GMK keying charges	\$75.00 / cyl
81▲†	Cylinder to accept Keso (83) and Keso F1 (F183) removable core – no core provided	No Addition
F182†	SARGENT Keso Security Cylinder – patented – new key systems	\$91.00 / cyl.
F183▲†	SARGENT Keso Security Removable Core Cylinder – patented – new key systems	\$130.00 / cyl.
82†	SARGENT Keso Security Cylinder (For existing systems only)	\$91.00 / cyl.
83▲†	SARGENT Keso Security Removable Core Cylinder (For existing systems only)	\$130.00 / cyl.
84▲†	SARGENT Keso Security Removable Construction Core Cylinder	See page CK-18
85	Tactile Warning - Abrasive coating on inside lever	\$49.00
86	Tactile Warning - Abrasive coating on outside lever	\$49.00
87	Tactile Warning - Abrasive coating on both levers	\$98.00
BR	SARGENT Bump Resistant Cylinders (N/A w/10, 22, 30, 60, 63, 64, 70, 72, 73, 737P, KESO, SC, & SE options)	\$25.00 /cyl.
DG1	Patented Degree DG1 Key System	No addition
DG160	Hardware prepared for DG1-6300 Lg. Format IC cores, supplied with temporary plastic construction cores	No addition
DG163	Patented Degree DG1 Large Format Interchangeable Core Cylinder - Includes master keying charges	\$83.00
DG164	Hardware prepared for DG1-6300 Lg. Format IC cores, supplied with temporary keyed construction cores	\$83.00
DG2	Patented Degree DG2 Key System incorporating a locking sidebar	\$63.00/cyl.
DG260	Hardware prepared for DG2-6300 Lg. Format IC cores, supplied with temporary plastic construction cores	No addition
DG263	Patented Degree DG2 Large Format Interchangeable Core Cylinder - Includes master keying charges	\$146.00
DG264	Hardware prepared for DG2-6300 Lg. Format IC cores, supplied with temporary keyed construction cores	\$83.00
DG3	Patented Degree DG3 Key System incorporating a locking sidebar and UL437 listed	\$89.00/cyl.
DG360	Hardware prepared for DG3-6300 Lg. Format IC cores, supplied with temporary plastic construction cores	No addition
DG363	Patented Degree DG3 Large Format Interchangeable Core Cylinder - Includes master keying charges	\$172.00
DG364	Hardware prepared for DG3-6300 Lg. Format IC cores, supplied with temporary keyed construction cores	\$83.00
DX	Deadbolt Monitoring (not available with LX option)	\$197.00
LC	Less Cylinder	-\$96.00/cyl.
LB	Extra large thumbturn	\$18.00
LX	Latchbolt Monitor – available with all non-deadbolt functions; not available with DX option	\$200.00
OBS	Open Back Strike	\$79.00
RX	Request to Exit	\$206.00
SC▲†	Schlage "C" Keyway cylinder, (Number 41 Cylinder Only, 0 bitted)	No addition
SE▲†	Schlage "E" Keyway cylinder, (Number 41 Cylinder Only, 0 bitted)	No addition
SG	MicroShield® – an antimicrobial powder coat finish	\$73.00
T1	Decorative thumbturn; backplate matches rose design chosen	No Addition
T2	Decorative square thumbturn; backplate matches rose design chosen	No Addition
T3	Decorative cylinder thumbturn; backplate matches rose design chosen	No Addition
WBS	Wrought Box Strike	No addition

NOTES: ▲ Options not available with a standard 50 function lockout cylinder. † Not available with 60, 63, 64 options.
** Specify "R" for Mortise Locks compatible with roseless collar.

CPC Clear Powder Coat over 26/26D – R8205 x R** G x RH x 26D x CPC \$67.00
All orders will continue to be handled as a "special" when CPC is ordered.

Experience a safer
and more open world

Copyright © 2002-2021 Sargent Manufacturing Company, an ASSA ABLOY Group company. All rights reserved.
Reproduction in whole or in part without the express written permission of Sargent Manufacturing Company is prohibited.
Contact us at: 800-727-5477 or visit www.sargentlock.com. In Canada contact us at: 800-461-3007 or visit www.assaabloydss.ca

SIMPLÍ™ ROSELESS TRIM R8200 MORTISE LOCK - COASTAL SERIES

USA & Canada Prices Effective May 1, 2021

Lever Designs:

*G, R, *S, *Y Levers



RG
Collar: R
Lever: G

How to order:

21-R8205 x R G x RH x 26D**
Option: 21
Function: R8205
Rose: R**
Lever: G
Hand: RH
Finish: 26D

* Handed: specify hand when ordering

** Specify "R" for Mortise Locks compatible with roseless collar.

Function		Finish	
		10BE/26D/BSP/WSP	03/04/09/10/10B/10BL/14/15/20D/26
Single Cyl			
R8204	Storeroom or Closet		
R8205	Office or Entry	\$1,214.00	\$1,238.00
R8237	Classroom		
R8255	Office or Entry		
R8206	Storeroom or Service		
R8231	Utility		
R8236	Closet		
R8256	Office or Inner Entry	\$1,244.00	\$1,268.00
R8257, R8258, R8267	Institutional Privacy		
Single Cyl With Deadbolt			
R8224	Room Door		
R8225	Dormitory or Exit		
R8227	Closet or Storeroom		
R8228, R8230	Dummy Trim Deadlock		
R8235	Storeroom	\$1,275.00	\$1,299.00
R8243	Apartment Corridor		
R8245	Dormitory or Exit		
R8247	Front Door or Apartment Corridor		
R8251	Storeroom Deadbolt		
R8250	Hotel Guest Lock	\$1,318.00	\$1,342.00
Double Cyl No Deadbolt			
R8216	Apartment or Exit or Public Toilet		
R8217	Asylum or Institutional		
R8238	Classroom Security Intruder	\$1,336.00	\$1,360.00
R8259	School Security		
Double Cyl With Deadbolt			
R8226	Store Door		
R8229	Dummy Trim Deadlock		
R8239, R8240	Classroom Security Intruder		
R8241	Classroom Security	\$1,362.00	\$1,386.00
R8246	Dormitory or Exit		
R8248	Store Door		
R8249	Security		
R8252	Institutional		
Electro Mechanical Single Cyl – Specify 12V or 24V			
R8270-12V / R8270-24V	Fail Safe	\$1,410.00	\$1,434.00
R8271-12V / R8271-24V	Fail Secure		
Electro Mechanical Double Cyl – Specify 12V or 24V			
R8272-12V / R8272-24V	Fail Safe	\$1,467.00	\$1,491.00
R8273-12V / R8273-24V	Fail Secure		
Non Keyed			
R8213	Communication or Exit	\$981.00	\$1,005.00
R8215	Passage or Closet		
R8265	Privacy Bedroom or Bath (Latch)	\$1,078.00	\$1,102.00
R8266, R8268	Privacy Bedroom or Bath (Deadbolt)	\$1,187.00	\$1,211.00
R8293*	Single Dummy Trim	\$400.00	\$412.00
R8294	Double Dummy Trim	\$802.00	\$826.00
R8295	Single Dummy Trim w/Lockbody	\$517.00	\$529.00
R8296	Double Dummy Trim w/Lockbody	\$921.00	\$945.00
R8297	Double Dummy w/Active Trim	\$1,019.00	\$1,043.00

ML-78 MORTISE LOCKS

SARGENT®

ASSA ABLOY

OPTIONS

USA & Canada Prices Effective May 1, 2021

Options	Description	Price
10▲	SARGENT Signature Key System	\$63.00 / cyl.
11†▲	SARGENT XC Key System (not available with 10, 22, SC, SE options)	No addition
1160	SARGENT XC Large Format Interchangeable Plastic Disposable Construction Core	No addition
1163	SARGENT XC Large Format Interchangeable Core Cylinder - Includes masterkeying charges	\$83.00
1164	SARGENT XC Large Format Interchangeable Construction Core Cylinder	\$83.00
1170	Small Format interchangeable disposable construction core - to accept 7 Pin XC permanent core	No addition
11727P	Small Format interchangeable keyed construction core - to accept 7 Pin XC permanent core	\$75.00
11737P	Small Format interchangeable core - to accept 7 pin XC permanent core	\$75.00 / cyl.
21▲†	SARGENT Construction Key System (lost ball) Standard on all new systems established since 5/1/96	\$16.00 / cyl.
22▲†	SARGENT Construction Key System (split key) To be used on pre-established split key systems only	\$32.00 / cyl.
23	Locksets with flat 4 7/8" ANSI strike	No addition
31	Thick Doors - Extended Lip Required - Specify Length C to E - Cylinders - IMPORTANT- See catalog 7800/8200 option page for cylinder limitations - Below charges DO NOT include additional charges for special cylinder requirements Doors up to 2-1/2" thick - lock centered Doors 2-5/8" to 6" thick OR doors 1-3/4" thick w/max 1" paneling one side. For example: Specify 1-3/4" door with panel (Side) on inside or outside	No addition Non Keyed function \$50.00 Keyed function \$100.00
49	Visual Status Indicator (available with 26, 29, 30, 36, 37, 38, 39, 40, 41 functions) or Occupancy Indicator with Emergency Release (available with 65, 66, 68 functions)	\$140.00
60	SARGENT Large Format Interchangeable Plastic Disposable Construction Core	No addition
63	SARGENT Large Format Interchangeable core cylinder, includes master keying charges	\$83.00 / cyl.
64	SARGENT Large Format Interchangeable Construction Core Cylinder	\$83.00
6573▲†	Small Format 6-Pin Uncombined Core (Refer to CK-12)	\$65.00 / cyl.
65737P▲†	Small Format 7-Pin Uncombined Core (Refer to CK-12)	\$65.00 / cyl.
70▲†	Small Format Interchangeable disposable plastic construction core	No addition
72▲†	Small Format Interchangeable 6-pin construction core (7-pin with 11 option)	See CK-2
73▲†	Small Format interchangeable core 6-pin Includes MK and GMK keying charges	\$75.00 / cyl
737P▲†	Small Format interchangeable core 7-pin (refer to CK-12 for available keyways) Includes MK and GMK keying charges	\$75.00 / cyl
81▲†	Cylinder to accept Keso (83) and Keso F1 (F183) removable core – no core provided	No addition
F182†	SARGENT Keso Security Cylinder – patented – new key systems	\$91.00 / cyl.
F183▲†	SARGENT Keso Security Removable Core Cylinder – patented – new key systems	\$130.00 / cyl.
82†	SARGENT Keso Security Cylinder (For existing systems only)	\$91.00 / cyl.
83▲†	SARGENT Keso Security Removable Core Cylinder (For existing systems only)	\$130.00 / cyl.
84▲†	SARGENT Keso Security Removable Construction Core Cylinder	See CK-18
85	Tactile Warning - Abrasive coating on inside lever	\$49.00
86	Tactile Warning - Abrasive coating on outside lever	\$49.00
87	Tactile Warning - Abrasive coating on both levers	\$98.00
BR	SARGENT Bump Resistant Cylinders (N/A w/10, 22, 30, 60, 63, 64, 70, 72, 73, 737P, KESO, SC, & SE options)	\$25.00 / cyl.
DG1	Patented Degree DG1 Key System	No addition
DG160	Hardware prepared for DG1-6300 Lg. Format IC cores, supplied with temporary plastic construction cores	No addition
DG163	Patented Degree DG1 Large Format Interchangeable Core Cylinder - Includes master keying charges	\$83.00
DG164	Hardware prepared for DG1-6300 Lg. Format IC cores, supplied with temporary keyed construction cores	\$83.00
DG2	Patented Degree DG2 Key System incorporating a locking sidebar	\$63.00/cyl.
DG260	Hardware prepared for DG2-6300 Lg. Format IC cores, supplied with temporary plastic construction cores	No addition
DG263	Patented Degree DG2 Large Format Interchangeable Core Cylinder - Includes master keying charges	\$146.00
DG264	Hardware prepared for DG2-6300 Lg. Format IC cores, supplied with temporary keyed construction cores	\$83.00
DG3	Patented Degree DG3 Key System incorporating a locking sidebar and UL437 listed	\$89.00/cyl.
DG360	Hardware prepared for DG3-6300 Lg. Format IC cores, supplied with temporary plastic construction cores	No addition
DG363	Patented Degree DG3 Large Format Interchangeable Core Cylinder - Includes master keying charges	\$172.00
DG364	Hardware prepared for DG3-6300 Lg. Format IC cores, supplied with temporary keyed construction cores	\$83.00
DX	Deadbolt Monitoring (not available with LX option)	\$197.00
LC	Less Cylinder	-\$96.00/cyl.
LB	Extra large thumbturn	\$18.00
LX	Latchbolt Monitor – available with all non-deadbolt functions; not available with DX option	\$200.00
OBS	Open Back Strike	\$79.00
RX	Request to Exit	\$206.00
SC▲†	Schlage "C" Keyway cylinder, (Number 41 Cylinder Only, 0 bitted)	No addition
SE▲†	Schlage "E" Keyway cylinder, (Number 41 Cylinder Only, 0 bitted)	No addition
SG	MicroShield® – an antimicrobial powder coat finish	\$73.00
T1	Decorative thumbturn; backplate matches rose design chosen	No Addition
T2	Decorative square thumbturn; backplate matches rose design chosen	No Addition
T3	Decorative cylinder thumbturn; backplate matches rose design chosen	No Addition
WBS	Wrought Box Strike	No addition

NOTES: ▲ Options not avail. with a standard 50 function lockout cylinder. † Not avail. with 60, 63, 64 options
** Specify "R" for Mortise Locks compatible with roseless collar.

CPC Clear Powder Coat over 26D/32D – R8205 x R** MM x RH x 32D x CPC \$67.00
All orders will continue to be handled as a "special" when CPC is ordered.

Experience a safer
and more open world

Copyright © 2002-2021 Sargent Manufacturing Company, an ASSA ABLOY Group company. All rights reserved.
Reproduction in whole or in part without the express written permission of Sargent Manufacturing Company is prohibited.
Contact us at: 800-727-5477 or visit www.sargentlock.com. In Canada contact us at: 800-461-3007 or visit www.assaabloydss.ca

ASSA ABLOY

SIMPLÍ™ ROSELESS TRIM R8200 MORTISE LOCKS - STUDIO COLLECTION LEVERS

USA & Canada Prices Effective May 1, 2021



RMI

Collar: R
Lever: MI



RMO

Roseless Trim: R
Lever: MO

Lever Designs:

Centro	Notting Hill	Aventura	Rialto	Odeon
MD	*MQ	MB	MO	*MH
MJ	*MM	ME	*MZ	*MS
ND	*MY	MF		*MU
NJ		MG		*MV
		MI		*MX
		MW		*NS
		NF		*NU

* Handed: specify hand when ordering

How to order: 21-R8205 x R** MM x RH x 26D

Option	21
Function	R8205
Rose	R**
Lever	MM
Hand	RH
Finish	26D

** Specify "R" for Mortise Locks compatible with roseless collar.

Function		Finish	
Single Cyl		10BE/26D/BSP/WSP	03/04/09/10/10B/10BL/14/15/20D/26/32/32D
R8204	Storeroom or Closet		
R8205	Office or Entry	\$1,214.00	\$1,238.00
R8237	Classroom		
R8255	Office or Entry		
R8206	Storeroom or Service		
R8231	Utility		
R8236	Closet		
R8256	Office or Inner Entry	\$1,244.00	\$1,268.00
R8257, R8258, R8267	Institutional Privacy		
Single Cyl With Deadbolt			
R8224	Room Door		
R8225	Dormitory or Exit		
R8227	Closet or Storeroom		
R8228, R8230	Dummy Trim Deadlock		
R8235	Storeroom	\$1,275.00	\$1,299.00
R8243	Apartment Corridor		
R8245	Dormitory or Exit		
R8247	Front Door or Apartment Corridor		
R8251	Storeroom Deadbolt		
R8250	Hotel Guest Lock	\$1,318.00	\$1,342.00
Double Cyl No Deadbolt			
R8216	Apartment or Exit or Public Toilet		
R8217	Asylum or Institutional		
R8238	Classroom Security Intruder	\$1,336.00	\$1,360.00
R8259	School Security		
Double Cyl With Deadbolt			
R8226	Store Door		
R8229	Dummy Trim Deadlock		
R8239, R8240	Classroom Security Intruder		
R8241	Classroom Security	\$1,362.00	\$1,386.00
R8246	Dormitory or Exit		
R8248	Store Door		
R8249	Security		
R8252	Institutional		
Electro Mechanical Single Cyl – Specify 12V or 24V			
R8270-12V / R8270-24V	Fail Safe	\$1,410.00	\$1,434.00
R8271-12V / R8271-24V	Fail Secure		
Electro Mechanical Double Cyl – Specify 12V or 24V			
R8272-12V / R8272-24V	Fail Safe	\$1,467.00	\$1,491.00
R8273-12V / R8273-24V	Fail Secure		
Non Keyed			
R8213	Communication or Exit	\$981.00	\$1,005.00
R8215	Passage or Closet		
R8265	Privacy Bedroom or Bath (Latch)	\$1,078.00	\$1,102.00
R8266, R8268	Privacy Bedroom or Bath (Deadbolt)	\$1,187.00	\$1,211.00
R8293*	Single Dummy Trim	\$400.00	\$412.00
R8294	Double Dummy Trim	\$802.00	\$826.00
R8295	Single Dummy Trim w/Lockbody	\$517.00	\$529.00
R8296	Double Dummy Trim w/Lockbody	\$921.00	\$945.00
R8297	Double Dummy w/Active Trim	\$1,019.00	\$1,043.00

ML-80 MORTISE LOCKS

SARGENT®

ASSA ABLOY

OPTIONS USA & Canada Prices Effective May 1, 2021

Options	Description	Price
1▲	8200 Line with 1-1/16" wide front for 1-3/8" doors.	\$62.00
3	Stainless steel hub (not available with 8289, 8291 & 8292 functions)	\$69.00
10▲	SARGENT Signature Key System	\$63.00 / cyl.
11†▲	SARGENT XC Key System (not available with 10, 22, SC, SE options)	No addition
1160	SARGENT XC Large Format Interchangeable Plastic Disposable Construction Core	No addition
1163	SARGENT XC Large Format Interchangeable Core Cylinder - Includes masterkeying charges	\$83.00
1164	SARGENT XC Large Format Interchangeable Construction Core Cylinder	\$83.00
1170	Small Format interchangeable disposable construction core - to accept 7 Pin XC permanent core	No addition
11727P	Small Format interchangeable keyed construction core - to accept 7 Pin XC permanent core	\$75.00
11737P	Small Format interchangeable core - to accept 7 pin XC permanent core	\$75.00 /cyl.
21▲†	SARGENT Construction Key System (lost ball) Standard on all new systems established since 5/1/96	\$16.00 / cyl.
22▲†	SARGENT Construction Key System (split key) To be used on pre-established split key systems only	\$32.00 / cyl.
23	Locksets with flat 4 7/8" ANSI strike	No addition
31	Thick Doors - Extended Lip Required - Specify Length C to E - Cylinders - IMPORTANT- See catalog 7800/8200 option page for cylinder limitations - Below charges DO NOT include additional charges for special cylinder requirements Doors up to 2-1/2" thick - lock centered Doors 2-5/8" to 6" thick OR doors 1-3/4" thick w/max 1" paneling one side. For example: Specify 1-3/4" door with panel (Side) on inside or outside	No addition Non Keyed function \$50.00 Keyed function \$100.00
60	SARGENT Large Format Interchangeable Plastic Disposable Construction Core	No addition
63	SARGENT Large Format Interchangeable core cylinder, includes master keying charges	\$83.00 / cyl.
64	SARGENT Large Format Interchangeable Construction Core Cylinder	\$83.00
6573▲†	Small Format 6-Pin Uncombined Core (Refer to CK-12)	\$65.00 / cyl.
65737P▲†	Small Format 7-Pin Uncombined Core (Refer to CK-12)	\$65.00 / cyl.
68	8200 Line furnished with lever handle outside x knob inside (Excludes SLD Detention Knob)	Defaults to 8200 Lever Lock Price
69	8200 Line furnished with lever handle inside x knob outside (Excludes SLD Detention Knob)	Defaults to 8200 Lever Lock Price
70▲†	Small Format Interchangeable disposable plastic construction core	No addition
72▲†	Small Format Interchangeable 6-pin construction core (7-pin with 11 option)	\$75.00
73▲†	Small Format interchangeable core 6-pin Includes MK and GMK keying charges	\$75.00 / cyl
737P▲†	Small Format interchangeable core 7-pin (refer to CK-12 for available keyways) Includes MK and GMK keying charges	\$75.00 / cyl
81▲†	Cylinder to accept Keso (83) and Keso F1 (F183) removable core – no core provided	No addition
F182†	SARGENT Keso Security Cylinder – patented – new key systems	\$91.00 / cyl.
F183▲†	SARGENT Keso Security Removable Core Cylinder – patented – new key systems	\$130.00 / cyl.
82†	SARGENT Keso Security Cylinder (For existing systems only)	\$91.00 / cyl.
83▲†	SARGENT Keso Security Removable Core Cylinder (For existing systems only)	\$130.00 / cyl.
84▲†	SARGENT Keso Security Removable Construction Core Cylinder	See CK-18
85	Tactile Warning - Abrasive coating on inside lever	\$49.00
86	Tactile Warning - Abrasive coating on outside lever	\$49.00
87	Tactile Warning - Abrasive coating on both levers	\$98.00
AV	Anti Vandal Pull Trim (available in 32D finish), (Not available with 8270, 8271, 8272, 8273 functions)	\$229.00
BR	SARGENT Bump Resistant Cylinders (N/A w/10, 22, 30, 60, 63, 64, 70, 72, 73, 737P, KESO, SC, & SE options)	\$25.00 /cyl.
DG1	Patented Degree DG1 Key System	No addition
DG160	Hardware prepared for DG1-6300 Lg. Format IC cores, supplied with temporary plastic construction cores	No addition
DG163	Patented Degree DG1 Large Format Interchangeable Core Cylinder - Includes master keying charges	\$83.00
DG164	Hardware prepared for DG1-6300 Lg. Format IC cores, supplied with temporary keyed construction cores	\$83.00
DG2	Patented Degree DG2 Key System incorporating a locking sidebar	\$63.00/cyl.
DG260	Hardware prepared for DG2-6300 Lg. Format IC cores, supplied with temporary plastic construction cores	No addition
DG263	Patented Degree DG2 Large Format Interchangeable Core Cylinder - Includes master keying charges	\$146.00
DG264	Hardware prepared for DG2-6300 Lg. Format IC cores, supplied with temporary keyed construction cores	\$83.00
DG3	Patented Degree DG3 Key System incorporating a locking sidebar and UL437 listed	\$89.00/cyl.
DG360	Hardware prepared for DG3-6300 Lg. Format IC cores, supplied with temporary plastic construction cores	No addition
DG363	Patented Degree DG3 Large Format Interchangeable Core Cylinder - Includes master keying charges	\$172.00
DG364	Hardware prepared for DG3-6300 Lg. Format IC cores, supplied with temporary keyed construction cores	\$83.00
IDP	Integrated Door Position Switch	\$108.00
LB	Extra large thumbturn	\$18.00
LC	Less Cylinder	-\$96.00/cyl.
OBS	Open Back Strike	\$79.00
PHR	Deadbolt Privacy Function (available w/deadbolt function only)	\$100.00
R01	Mercury and Lenel compatible 1KΩ/2KΩ resistance supervision	\$100.00
R03	Software House compatible 1KΩ/2KΩ resistance supervision	\$100.00
R04	AMAG compatible 4-state supervision	\$100.00
SC▲†	Schlage "C" Keyway cylinder, (Number 41 Cylinder Only, 0 bitted)	No addition
SE▲†	Schlage "E" Keyway cylinder, (Number 41 Cylinder Only, 0 bitted)	No addition
SG	MicroShield® – an antimicrobial powder coat finish	\$73.00
WBS	Wrought Box Strike	No addition

NOTES: ▲ Options not avail. with a standard 50 function lockout cylinder. † Not avail. with 60, 63, 64 options

CPC	Clear Powder Coat over 26D/32D – NAC-82280-24V x CEMD x RH x 32D x CPC All orders will continue to be handled as a "special" when CPC is ordered.	\$67.00
-----	--	---------

Experience a safer
and more open world

Copyright © 2002-2021 Sargent Manufacturing Company, an ASSA ABLOY Group company. All rights reserved.
Reproduction in whole or in part without the express written permission of Sargent Manufacturing Company is prohibited.
Contact us at: 800-727-5477 or visit www.sargentlock.com. In Canada contact us at: 800-461-3007 or visit www.assaabloydss.ca

USA & Canada Prices Effective May 1, 2021



RMI

Collar: R
Lever: MI



RMO

Roseless Trim: R
Lever: MO

Lever Designs:

Coastal†	Centro	Notting Hill	Aventura	Rialto	Odeon
*G	MD	*MQ	MB	MO	*MH
R	MJ	*MM	ME	*MZ	*MS
*S	ND	*MY	MF		*MU
*Y	NJ		MG		*MV
			MI		*MX
			MW		*NS
			NF		*NU

* Handed: specify hand when ordering

How to order: NAC-82284-12V x R** MM x RH x 26D

Option	21
Function	R8205
Rose	R**
Lever	MM
Hand	RH
Finish	26D

** Specify "R" for Mortise Locks compatible with roseless collar.

NAC 8200 Electrified Mortise Locks with High Security Monitoring				10BE/26D/ BSP/WSP	03/04/09/10/ 10B/10BL/14/15/ 20D/26†32†32D
Option	Function	Trim - Proximity Entry	Description		
NAC	R82270-12V/-24V	Rose x Lever Design	Fail Safe w/Cylinder Override	\$1,585.00	\$1,609.00
NAC	R82271-12V/-24V	Rose x Lever Design	Fail Secure w/Cylinder Override		
NAC	R82280-12V/-24V	Rose x Lever Design	Fail Safe w/Deadbolt w/Cyl.Override	\$1,660.00	\$1,684.00
NAC	R82281-12V/-24V	Rose x Lever Design	Fail Secure w/D.bolt w/Cyl.Override		
NAC	R82274-12V/-24V	Rose x Lever Design	Fail Safe - No Cylinder	\$1,530.00	\$1,554.00
NAC	R82275-12V/-24V	Rose x Lever Design	Fail Secure - No Cylinder		
NAC	R82284-12V/-24V	Rose x Lever Design	Fail Safe w/Deadbolt - No Cylinder	\$1,605.00	\$1,629.00
NAC	R82285-12V/-24V	Rose x Lever Design	Fail Secure w/Deadbolt - No Cylinder		

Note: Consult catalog for ordering information.

* Specify hand and voltage (12v or 24v) when ordering.

† Coastal and MH, MM, MO, MQ, MS, MU, MV, MX, MY, MZ, NS, NU levers are not available in 32 and 32D finishes.

ML-82 MORTISE LOCKS

For V Series
Indicators
Click / See
Page ML-1A

SARGENT®

ASSA ABLOY

OPTIONS

USA & Canada Prices Effective May 1, 2021

Options	Description	Price
1▲	7800 Line with 1-1/16" wide front for 1-3/8" doors.	\$62.00
10▲	SARGENT Signature Key System	\$63.00 / cyl.
11†▲	SARGENT XC Key System (not available with 10, 22, SC, SE options)	No addition
1160	SARGENT XC Large Format Interchangeable Plastic Disposable Construction Core	No addition
1163	SARGENT XC Large Format Interchangeable Core Cylinder - Includes masterkeying charges	\$83.00
1164	SARGENT XC Large Format Interchangeable Construction Core Cylinder	83
1170	Small Format interchangeable disposable construction core - to accept 7 Pin XC permanent core	No addition
11727P	Small Format interchangeable keyed construction core - to accept 7 Pin XC permanent core	\$75.00
11737P	Small Format interchangeable core - to accept 7 pin XC permanent core	\$75.00 / cyl.
21▲†	SARGENT Construction Key System (lost ball) Standard on all new systems established since 5/1/96	\$16.00 / cyl.
22▲†	SARGENT Construction Key System (split key) To be used on pre-established split key systems only	\$32.00 / cyl.
23	Locksets with flat 4-7/8" ANSI strike	No addition
31	Thick Doors - Extended Lip Required - Specify Length C to E	
	- Cylinders - IMPORTANT- See catalog 7800/8200 option page for cylinder limitations	
	- Below charges DO NOT include additional charges for special cylinder requirements	
	Doors up to 2-1/2" thick - lock centered	No addition
	Doors 2-5/8" to 6" thick OR doors 1-3/4" thick w/max 1" paneling one side.	
	For example: Specify 1-3/4" door with panel (Side) on inside or outside	Non Keyed function \$50.00 Keyed function \$100.00
36	6 Lobe security head screws	\$24.00
37	Spanner head screws	\$17.00
49	Visual Status Indicator - Available with 30, 36, 37 function - Rose Trims 7800 CR, E, L, LN, O, TR	
	- Available with 26, 29, 38, 39 40, 41 functions - Rose Trim 8200 LN	\$140.00
49	Occupancy Indicator with emergency Release - Available with 65, 66, 68 functions; Rose Trims 7800 CR, E, L, LN, O, TR	\$140.00
50*	Secured Indicator Rose- doors 1-5/8" to 2-1/4" thick- Avail.w/24,25,26,28,29,30,36,37,38,39,40,41,43,45,50,51,52,57,58,67 functions	\$140.00
60	SARGENT Large Format Interchangeable Plastic Disposable Construction Core	No addition
63	SARGENT Large Format Interchangeable core cylinder, includes master keying charges	\$83.00 / cyl.
64	SARGENT Large Format Interchangeable Construction Core Cylinder	\$83.00
6573▲†	Small Format 6-Pin Uncombined Core (Refer to CK-12)	\$65.00 / cyl.
65737P▲†	Small Format 7-Pin Uncombined Core (Refer to CK-12)	\$65.00 / cyl.
68	8200 Line furnished with lever handle outside x knob inside (Excludes SLD Detention Knob)	Defaults to 8200 Lever Lock Price
69	8200 Line furnished with lever handle inside x knob outside (Excludes SLD Detention Knob)	Defaults to 8200 Lever Lock Price
70▲†	Small Format Interchangeable disposable plastic construction core	No addition
72▲†	Small Format Interchangeable 6-pin construction core (7-pin with 11 option)	\$75.00
73▲†	Small Format interchangeable core 6-pin Includes MK and GMK keying charges	\$75.00 / cyl
737P▲†	Small Format interchangeable core 7-pin (refer to CK-12 for available keyways) Includes MK and GMK keying charges	\$75.00 / cyl
74	Lock case wrapped in lead - handing required (roses not available)	\$294.00
75	Tactile Warning - Milled Inside Knob	\$78.00
76	Tactile Warning - Milled Outside Knob	\$78.00
77	Tactile Warning - Milled Outside and Inside Knob	\$156.00
81▲†	Cylinder to accept Keso (83) and Keso F1 (F183) removable core - no core provided	No addition
F182†	SARGENT Keso Security Cylinder - patented - new key systems	\$91.00 / cyl.
F183▲†	SARGENT Keso Security Removable Core Cylinder - patented - new key systems	\$130.00 / cyl.
82†	SARGENT Keso Security Cylinder (For existing systems only)	\$91.00 / cyl.
83▲†	SARGENT Keso Security Removable Core Cylinder (For existing systems only)	\$130.00 / cyl.
84▲†	SARGENT Keso Security Removable Construction Core Cylinder	See CK-18
85	Tactile Warning - Abrasive Coating on Inside Knob	\$49.00
86	Tactile Warning - Abrasive Coating on Outside Knob	\$49.00
87	Tactile Warning - Abrasive Coating on Outside & Inside Knob	\$98.00
AV	Anti Vandal Pull Trim (available in 32D finish)	\$229.00
BR	SARGENT Bump Resistant Cylinders (N/A w/10, 22, 30, 60, 63, 64, 70, 72, 73, 737P, KESO, SC, & SE options)	\$25.00 / cyl.
DG1	Patented Degree DG1 Key System	No addition
DG160	Hardware prepared for DG1-6300 Lg. Format IC cores, supplied with temporary plastic construction cores	No addition
DG163	Patented Degree DG1 Large Format Interchangeable Core Cylinder - Includes master keying charges	\$83.00
DG164	Hardware prepared for DG1-6300 Lg. Format IC cores, supplied with temporary keyed construction cores	\$83.00
DG2	Patented Degree DG2 Key System incorporating a locking sidebar	\$63.00/cyl.
DG260	Hardware prepared for DG2-6300 Lg. Format IC cores, supplied with temporary plastic construction cores	No addition
DG263	Patented Degree DG2 Large Format Interchangeable Core Cylinder - Includes master keying charges	\$146.00
DG264	Hardware prepared for DG2-6300 Lg. Format IC cores, supplied with temporary keyed construction cores	\$83.00
DG3	Patented Degree DG3 Key System incorporating a locking sidebar and UL437 listed	\$89.00/cyl.
DG360	Hardware prepared for DG3-6300 Lg. Format IC cores, supplied with temporary plastic construction cores	No addition
DG363	Patented Degree DG3 Large Format Interchangeable Core Cylinder - Includes master keying charges	\$172.00
DG364	Hardware prepared for DG3-6300 Lg. Format IC cores, supplied with temporary keyed construction cores	\$83.00
DX	Deadbolt Monitoring (not available with 50, 74)	\$197.00
LC	Less Cylinder	-\$96.00/cyl.
OBS	Open Back Strike	\$79.00
SC▲†	Schlage "C" Keyway cylinder, (Number 41 Cylinder Only, 0-bitted)	No addition
SE▲†	Schlage "E" Keyway cylinder, (Number 41 Cylinder Only, 0-bitted)	No addition
SG	MicroShield® - an antimicrobial powder coat finish	\$73.00
WBS	Wrought Box Strike	No addition

NOTES: ▲ Options not available with a standard 50 function lockout cylinder. † Not available with 60, 63, 64 options.

CPC	Clear Powder Coat over 26D/32D - 7805 x OB x 32D x CPC All orders will continue to be handled as a "special" when CPC is ordered.	\$67.00
-----	--	---------

Experience a safer
and more open world

Copyright © 2002-2021 Sargent Manufacturing Company, an ASSA ABLOY Group company. All rights reserved.
Reproduction in whole or in part without the express written permission of Sargent Manufacturing Company is prohibited.
Contact us at: 800-727-5477 or visit www.sargentlock.com. In Canada contact us at: 800-461-3007 or visit www.assaabloydss.ca

USA & Canada Prices Effective May 1, 2021



OB
O, E, L, Rose • B-C Knob

Function		Finish	
		10BE/26D/BSP/WSP	03/04/09/10/10B/10BL/14/15/20D/26/32/32D
Single Cyl			
7804	Storeroom or Closet		
7805	Office or Entry		
7837	Classroom	\$1,111.00	\$1,135.00
7855	Office or Entry		
7806	Storeroom or Service		
7831	Utility		
7836	Closet	\$1,140.00	\$1,164.00
7856	Office or Inner Entry		
7857, 7858, 7867	Institutional Privacy		
Single Cyl With Deadbolt			
7824	Room Door		
7825	Dormitory or Exit		
7827	Closet or Storeroom		
7828, 7830	Dummy Trim Deadlock		
7835	Storeroom	\$1,169.00	\$1,193.00
7843	Apartment Corridor		
7845	Dormitory or Exit		
7847	Front Door or Apartment Corridor		
7851	Storeroom Deadbolt		
7850	Hotel Guest Lock	\$1,210.00	\$1,234.00
Double Cyl No Deadbolt			
7816	Apartment or Exit or Public Toilet		
7817	Asylum or Institutional	\$1,228.00	\$1,252.00
7838	Classroom Security Intruder		
Double Cyl With Deadbolt			
7826	Store Door		
7829	Dummy Trim Deadlock		
7839, 7840	Classroom Security Intruder		
7841	Classroom Security	\$1,253.00	\$1,277.00
7846	Dormitory or Exit		
7848	Store Door		
7852	Institutional		
Non Keyed			
7813	Communication or Exit	\$924.00	\$948.00
7815	Passage or Closet		
7865	Privacy Bedroom or Bath (Latch)	\$1,047.00	\$1,071.00
7866, 7868	Privacy Bedroom or Bath (Deadbolt)	\$1,087.00	\$1,111.00
7893	Single Dummy Trim	\$361.00	\$373.00
7894	Double Dummy Trim	\$718.00	\$742.00
7895	Single Dummy Trim w/Lockbody	\$466.00	\$478.00
7896	Double Dummy Trim w/Lockbody	\$833.00	\$857.00
7897	Double Dummy w/Active Trim	\$924.00	\$948.00

ML-84 MORTISE LOCKS

For V Series
Indicators
Click / See
Page ML-1A

SARGENT®

ASSA ABLOY

OPTIONS

USA & Canada Prices Effective May 1, 2021

Options	Description	Price
1▲	7800 Line with 1-1/16" wide front for 1-3/8" doors.	\$62.00
10▲	SARGENT Signature Key System	\$63.00 / cyl.
11†▲	SARGENT XC Key System (not available with 10, 22, SC, SE options)	No addition
1160	SARGENT XC Large Format Interchangeable Plastic Disposable Construction Core	No addition
1163	SARGENT XC Large Format Interchangeable Core Cylinder - Includes masterkeying charges	\$83.00
1164	SARGENT XC Large Format Interchangeable Construction Core Cylinder	\$83.00
1170	Small Format interchangeable disposable construction core - to accept 7 Pin XC permanent core	No addition
11727P	Small Format interchangeable keyed construction core - to accept 7 Pin XC permanent core	\$75.00
11737P	Small Format interchangeable core - to accept 7 pin XC permanent core	\$75.00 /cyl.
21▲†	SARGENT Construction Key System (lost ball) Standard on all new systems established since 5/1/96	\$16.00 / cyl.
22▲†	SARGENT Construction Key System (split key) To be used on pre-established split key systems only	\$32.00 / cyl.
31	Thick Doors - Extended Lip Required - Specify Length C to E - Cylinders - IMPORTANT- See catalog 7800/8200 option page for cylinder limitations - Below charges DO NOT include additional charges for special cylinder requirements Doors up to 2-1/2" thick - lock centered Doors 2-5/8" to 6" thick OR doors 1-3/4" thick w/max 1" paneling one side. For example: Specify 1-3/4" door with panel (Side) on inside or outside	No addition Non Keyed function \$50.00 Keyed function \$100.00
36	6 Lobe security head screws	\$24.00
37	Spanner head screws	\$17.00
60	SARGENT Large Format Interchangeable Plastic Disposable Construction Core	No addition
63	SARGENT Large Format Interchangeable core cylinder, includes master keying charges	\$83.00 / cyl.
64	SARGENT Large Format Interchangeable Construction Core Cylinder	\$83.00
6573▲†	Small Format 6-Pin Uncombined Core (Refer to CK-12)	\$65.00 / cyl.
65737P▲†	Small Format 7-Pin Uncombined Core (Refer to CK-12)	\$65.00 / cyl.
68	8200 Line furnished with lever handle outside x knob inside (Excludes SLD Detention Knob)	Defaults to 8200 Lever Lock Price
69	8200 Line furnished with lever handle inside x knob outside (Excludes SLD Detention Knob)	Defaults to 8200 Lever Lock Price
70▲†	Small Format Interchangeable disposable plastic construction core	No addition
72▲†	Small Format Interchangeable 6-pin construction core (7-pin with 11 options)	\$75.00
73▲†	Small Format interchangeable core 6-pin Includes MK and GMK keying charges	\$75.00 / cyl
737P▲†	Small Format interchangeable core 7-pin (refer to CK-12 for available keyways) Includes MK and GMK keying charges	\$75.00 / cyl
75	Tactile Warning - Milled Inside Knob	\$78.00
76	Tactile Warning - Milled Outside Knob	\$78.00
77	Tactile Warning - Milled Outside and Inside Knob	\$156.00
81▲†	Cylinder to accept Keso (83) and Keso F1 (F183) removable core – no core provided	No addition
F182†	SARGENT Keso Security Cylinder – patented – new key systems	\$91.00 / cyl.
F183▲†	SARGENT Keso Security Removable Core Cylinder – patented – new key systems	\$130.00 / cyl.
82†	SARGENT Keso Security Cylinder (For existing systems only)	\$91.00 / cyl.
83▲†	SARGENT Keso Security Removable Core Cylinder (For existing systems only)	\$130.00 / cyl.
84▲†	SARGENT Keso Security Removable Construction Core Cylinder	See CK-18
85	Tactile Warning - Abrasive Coating on Inside Knob	\$49.00
86	Tactile Warning - Abrasive Coating on Outside Knob	\$49.00
87	Tactile Warning - Abrasive Coating on Outside & Inside Knob	\$98.00
AV	Anti Vandal Pull Trim (available in 32D finish)	\$229.00
BR	SARGENT Bump Resistant Cylinders (N/A w/10, 22, 30, 60, 63, 64, 70, 72, 73, 737P, KESO, SC, & SE options)	\$25.00 /cyl.
DG1	Patented Degree DG1 Key System	No addition
DG160	Hardware prepared for DG1-6300 Lg. Format IC cores, supplied with temporary plastic construction cores	No addition
DG163	Patented Degree DG1 Large Format Interchangeable Core Cylinder - Includes master keying charges	\$83.00
DG164	Hardware prepared for DG1-6300 Lg. Format IC cores, supplied with temporary keyed construction cores	\$83.00
DG2	Patented Degree DG2 Key System incorporating a locking sidebar	\$63.00/cyl.
DG260	Hardware prepared for DG2-6300 Lg. Format IC cores, supplied with temporary plastic construction cores	No addition
DG263	Patented Degree DG2 Large Format Interchangeable Core Cylinder - Includes master keying charges	\$146.00
DG264	Hardware prepared for DG2-6300 Lg. Format IC cores, supplied with temporary keyed construction cores	\$83.00
DG3	Patented Degree DG3 Key System incorporating a locking sidebar and UL437 listed	\$89.00/cyl.
DG360	Hardware prepared for DG3-6300 Lg. Format IC cores, supplied with temporary plastic construction cores	No addition
DG363	Patented Degree DG3 Large Format Interchangeable Core Cylinder - Includes master keying charges	\$172.00
DG364	Hardware prepared for DG3-6300 Lg. Format IC cores, supplied with temporary keyed construction cores	\$83.00
DX	Deadbolt Monitoring (not available with 50, 74)	\$197.00
LC	Less Cylinder	-\$96.00/cyl.
OBS	Open Back Strike	\$79.00
SC▲†	Schlage "C" Keyway cylinder, (Number 41 Cylinder Only, 0 bitted)	No addition
SE▲†	Schlage "E" Keyway cylinder, (Number 41 Cylinder Only, 0 bitted)	No addition
SG	MicroShield® – an antimicrobial powder coat finish	\$73.00
WBS	Wrought Box Strike	No addition

NOTES: ▲ Options not available with a standard 50 function lockout cylinder. † Not available with 60, 63, 64 options.

CPC	Clear Powder Coat over 26D/32D – 7805 x KW1B x RH x 32D x CPC All orders will continue to be handled as a "special" when CPC is ordered.	\$67.00
-----	---	---------

Experience a safer
and more open world

Copyright © 2002-2021 Sargent Manufacturing Company, an ASSA ABLOY Group company. All rights reserved.
Reproduction in whole or in part without the express written permission of Sargent Manufacturing Company is prohibited.
Contact us at: 800-727-5477 or visit www.sargentlock.com. In Canada contact us at: 800-461-3007 or visit www.assaabloydss.ca

SARGENT®

ASSA ABLOY

For V Series Indicators Click / See Page ML-1A

*Note: VN1 escutcheon used with indicator only. Refer to page ML-1A for more information. Indicator option code must be specified.

ML-85 MORTISE LOCKS

7800

USA & Canada
Prices Effective
May 1, 2021

KW1 Escutcheon
B-C Knob



KW1B

KE1 Escutcheon
B-C Knob
Prices shown

KE2, KE3, KE4
Escutcheons
– refer to ML-40
for add



KE1B



VN1*

Single Cyl	Finish		Finish	
	10BE/26D BSP/WSP	03/04/09/10/10B/10BL 14/15/20D/26/32/32D	10BE/26D BSP/WSP	03/04/09/10/10B/10BL 14/15/20D/26/32/32D
7804 Storeroom or Closet				
7805 Office or Entry	\$1,225.00	\$1,249.00	\$1,338.00	\$1,362.00
7837 Classroom				
7855 Office or Entry				
7806 Storeroom or Service				
7831 Utility				
7836 Closet	\$1,248.00	\$1,272.00	\$1,367.00	\$1,391.00
7856 Office or Inner Entry				
7857, 7858, 7867 Institutional Privacy				
Single Cyl With Deadbolt				
7824 Room Door				
7825 Dormitory or Exit				
7827 Closet or Storeroom				
7828, 7830 Dummy Trim Deadlock				
7835 Storeroom	\$1,284.00	\$1,308.00	\$1,396.00	\$1,420.00
7843 Apartment Corridor				
7845 Dormitory or Exit				
7847 Front Door or Apartment Corridor				
7851 Storeroom Deadbolt				
7850 Hotel Guest Lock	\$1,324.00	\$1,348.00	\$1,439.00	\$1,463.00
Double Cyl No Deadbolt				
7816 Apartment or Exit or Public Toilet			NOT AVAILABLE IN KE3 & KE4	
7817 Asylum or Institutional	\$1,338.00	\$1,362.00	\$1,454.00	\$1,478.00
7838 Classroom Security Intruder				
Double Cyl With Deadbolt				
7826 Store Door			NOT AVAILABLE IN KE3 & KE4	
7829 Dummy Trim Deadlock				
7839, 7840 Classroom Security Intruder	\$1,367.00	\$1,391.00	\$1,482.00	\$1,506.00
7841 Classroom Security				
7846 Dormitory or Exit				
7848 Store Door				
7852 Institutional				
Non Keyed				
7813 Communication or Exit	\$1,034.00	\$1,058.00	\$1,148.00	\$1,172.00
7815 Passage or Closet				
7865 Privacy Bedroom or Bath (Latch)	\$1,155.00	\$1,179.00	\$1,271.00	\$1,295.00
7866, 7868 Privacy Bedroom or Bath (Deadbolt)	\$1,199.00	\$1,223.00	\$1,313.00	\$1,337.00
7893 Single Dummy Trim	\$413.00	\$425.00	\$475.00	\$487.00
7894 Double Dummy Trim	\$833.00	\$857.00	\$944.00	\$968.00
7895 Single Dummy Trim w/Lockbody	\$526.00	\$538.00	\$584.00	\$596.00
7896 Double Dummy Trim w/Lockbody	\$940.00	\$964.00	\$1,054.00	\$1,078.00
7897 Double Dummy w/Active Trim	\$1,034.00	\$1,058.00	\$1,148.00	\$1,172.00

Escutcheon Variations

Standard Cylinder	KE2	x concealed mounting	\$32.00
Non-Keyed Function	KE2	x concealed mounting	\$32.00
Cylinder Barrel Only	KE3	x exposed screws (not avail. in double cyl. functions)	\$91.00 Set
Non-Keyed Function	KE3	x exposed screws	\$32.00
Cylinder Barrel Only	KE4	x concealed mounting (not avail. in double cyl. functions)	\$101.00
Non-Keyed Function	KE4	x concealed mounting	\$32.00

Experience a safer
and more open world

Copyright © 2002-2021 Sargent Manufacturing Company, an ASSA ABLOY Group company. All rights reserved.
Reproduction in whole or in part without the express written permission of Sargent Manufacturing Company is prohibited.
Contact us at: 800-727-5477 or visit www.sargentlock.com. In Canada contact us at: 800-461-3007 or visit www.assaabloydss.ca

ML-86 MORTISE LOCKS

SARGENT®

ASSA ABLOY

OPTIONS

USA & Canada Prices Effective May 1, 2021

Options	Description	Price
1▲	7800 Line with 1-1/16" wide front for 1-3/8" doors.	\$62.00
10▲	SARGENT Signature Key System	\$63.00 / cyl.
11† ▲	SARGENT XC Key System (not available with 10, 22, SC, SE options)	No addition
1160	SARGENT XC Large Format Interchangeable Plastic Disposable Construction Core	No addition
1163	SARGENT XC Large Format Interchangeable Core Cylinder - Includes masterkeying charges	\$83.00
1164	SARGENT XC Large Format Interchangeable Construction Core Cylinder	\$83.00
1170	Small Format interchangeable disposable construction core - to accept 7 Pin XC permanent core	No addition
11727P	Small Format interchangeable keyed construction core - to accept 7 Pin XC permanent core	\$75.00
11737P	Small Format interchangeable core - to accept 7 pin XC permanent core	\$75.00 / cyl.
21▲†	SARGENT Construction Key System (lost ball) Standard on all new systems established since 5/1/96	\$16.00 / cyl.
22▲†	SARGENT Construction Key System (split key) To be used on pre-established split key systems only	\$32.00 / cyl.
23	Locksets with flat 4-7/8" ANSI strike	No addition
31	Thick Doors - Extended Lip Required - Specify Length C to E - Cylinders - IMPORTANT- See catalog 7800/8200 option page for cylinder limitations - Below charges DO NOT include additional charges for special cylinder requirements	
	Doors up to 2-1/2" thick - lock centered	No addition
	Doors 2-5/8" to 6" thick OR doors 1-3/4" thick w/max 1" paneling one side.	
	For example: Specify 1-3/4" door with panel (Side) on inside or outside	Non Keyed function \$50.00 Keyed function \$100.00
36	6 Lobe security head screws	\$24.00
37	Spanner head screws	\$17.00
60	SARGENT Large Format Interchangeable Plastic Disposable Construction Core	No addition
63	SARGENT Large Format Interchangeable core cylinder, includes master keying charges	\$83.00 / cyl.
64	SARGENT Large Format Interchangeable Construction Core Cylinder	\$83.00
6573▲†	Small Format 6-Pin Uncombined Core (Refer to CK-12)	\$65.00 / cyl.
65737P▲†	Small Format 7-Pin Uncombined Core (Refer to CK-12)	\$65.00 / cyl.
68	8200 Line furnished with lever handle outside x knob inside (Excludes SLD Detention Knob)	Defaults to 8200 Lever Lock Price
69	8200 Line furnished with lever handle inside x knob outside (Excludes SLD Detention Knob)	Defaults to 8200 Lever Lock Price
70▲†	Small Format Interchangeable disposable plastic construction core	No addition
72▲†	Small Format Interchangeable 6-pin construction core (7-pin with 11 options)	\$75.00
73▲†	Small Format interchangeable core 6-pin Includes MK and GMK keying charges	\$75.00 / cyl
737P▲†	Small Format interchangeable core 7-pin (refer to CK-12 for available keyways) Includes MK and GMK keying charges	\$75.00 / cyl
75	Tactile Warning - Milled Inside Knob	\$78.00
76	Tactile Warning - Milled Outside Knob	\$78.00
77	Tactile Warning - Milled Outside and Inside Knob	\$156.00
81▲†	Cylinder to accept Keso (83) and Keso F1 (F183) removable core – no core provided	No addition
F182†	SARGENT Keso Security Cylinder – patented – new key systems	\$91.00 / cyl.
F183▲†	SARGENT Keso Security Removable Core Cylinder – patented – new key systems	\$130.00 / cyl.
82†	SARGENT Keso Security Cylinder (For existing systems only)	\$91.00 / cyl.
83▲†	SARGENT Keso Security Removable Core Cylinder (For existing systems only)	\$130.00 / cyl.
84▲†	SARGENT Keso Security Removable Construction Core Cylinder	See CK-18
85	Tactile Warning - Abrasive Coating on Inside Knob	\$49.00
86	Tactile Warning - Abrasive Coating on Outside Knob	\$49.00
87	Tactile Warning - Abrasive Coating on Outside & Inside Knob	\$98.00
AV	Anti Vandal Pull Trim (available in 32D finish)	\$229.00
BR	SARGENT Bump Resistant Cylinders (N/A w/10, 22, 30, 60, 63, 64, 70, 72, 73, 737P, KESO, SC, & SE options)	\$25.00 /cyl.
DG1	Patented Degree DG1 Key System	No addition
DG160	Hardware prepared for DG1-6300 Lg. Format IC cores, supplied with temporary plastic construction cores	No addition
DG163	Patented Degree DG1 Large Format Interchangeable Core Cylinder - Includes master keying charges	\$83.00
DG164	Hardware prepared for DG1-6300 Lg. Format IC cores, supplied with temporary keyed construction cores	\$83.00
DG2	Patented Degree DG2 Key System incorporating a locking sidebar	\$63.00/cyl.
DG260	Hardware prepared for DG2-6300 Lg. Format IC cores, supplied with temporary plastic construction cores	No addition
DG263	Patented Degree DG2 Large Format Interchangeable Core Cylinder - Includes master keying charges	\$146.00
DG264	Hardware prepared for DG2-6300 Lg. Format IC cores, supplied with temporary keyed construction cores	\$83.00
DG3	Patented Degree DG3 Key System incorporating a locking sidebar and UL437 listed	\$89.00/cyl.
DG360	Hardware prepared for DG3-6300 Lg. Format IC cores, supplied with temporary plastic construction cores	No addition
DG363	Patented Degree DG3 Large Format Interchangeable Core Cylinder - Includes master keying charges	\$172.00
DG364	Hardware prepared for DG3-6300 Lg. Format IC cores, supplied with temporary keyed construction cores	\$83.00
DX	Deadbolt Monitoring (not available with 50, 74)	\$197.00
LC	Less Cylinder	-\$96.00/cyl.
OBS	Open Back Strike	\$79.00
SC▲†	Schlage "C" Keyway cylinder, (Number 41 Cylinder Only, 0-bitted)	No addition
SE▲†	Schlage "E" Keyway cylinder, (Number 41 Cylinder Only, 0-bitted)	No addition
SG	MicroShield® – an antimicrobial powder coat finish	\$73.00
WBS	Wrought Box Strike	No addition

NOTES: ▲ Options not available with a standard 50 function lockout cylinder. † Not available with 60, 63, 64 options.

CPC	Clear Powder Coat over 26D/32D – 7805 x WTB x RH x 32D x CPC All orders will continue to be handled as a "special" when CPC is ordered.	\$67.00
-----	--	---------

Experience a safer
and more open world

Copyright © 2002-2021 Sargent Manufacturing Company, an ASSA ABLOY Group company. All rights reserved.
Reproduction in whole or in part without the express written permission of Sargent Manufacturing Company is prohibited.
Contact us at: 800-727-5477 or visit www.sargentlock.com. In Canada contact us at: 800-461-3007 or visit www.assaabloydss.ca

USA & Canada Prices Effective May 1, 2021



WTB
WT Escutcheon • B-C Knob

Function		Finish	
		10BE/26D/BSP/WSP	03/04/09/10/10B/10BL/14/15/20D/26/32/32D
Single Cyl			
7804	Storeroom or Closet		
7805	Office or Entry	\$1,155.00	\$1,179.00
7837	Classroom		
7855	Office or Entry		
7806	Storeroom or Service		
7831	Utility		
7836	Closet	\$1,179.00	\$1,203.00
7856	Office or Inner Entry		
7857, 7858, 7867	Institutional Privacy		
Single Cyl With Deadbolt			
7824	Room Door		
7825	Dormitory or Exit		
7827	Closet or Storeroom		
7828, 7830	Dummy Trim Deadlock		
7835	Storeroom	\$1,210.00	\$1,234.00
7843	Apartment Corridor		
7845	Dormitory or Exit		
7847	Front Door or Apartment Corridor		
7851	Storeroom Deadbolt		
7850	Hotel Guest Lock	\$1,253.00	\$1,277.00
Double Cyl No Deadbolt			
7816	Apartment or Exit or Public Toilet		
7817	Asylum or Institutional	\$1,271.00	\$1,295.00
7838	Classroom Security Intruder		
Double Cyl With Deadbolt			
7826	Store Door		
7829	Dummy Trim Deadlock		
7839, 7840	Classroom Security Intruder		
7841	Classroom Security	\$1,298.00	\$1,322.00
7846	Dormitory or Exit		
7848	Store Door		
7852	Institutional		
Non Keyed			
7813	Communication or Exit	\$968.00	\$992.00
7815	Passage or Closet		
7865	Privacy Bedroom or Bath (Latch)	\$1,087.00	\$1,111.00
7866, 7868	Privacy Bedroom or Bath (Deadbolt)	\$1,135.00	\$1,159.00
7893	Single Dummy Trim	\$381.00	\$393.00
7894	Double Dummy Trim	\$765.00	\$789.00
7895	Single Dummy Trim w/Lockbody	\$490.00	\$502.00
7896	Double Dummy Trim w/Lockbody	\$870.00	\$894.00
7897	Double Dummy w/Active Trim	\$968.00	\$992.00

ML-88 MORTISE LOCKS

SARGENT®

ASSA ABLOY

OPTIONS

USA & Canada Prices Effective May 1, 2021

Options	Description	Price
10▲	SARGENT Signature Key System	\$63.00 / cyl.
11▲	SARGENT XC Key System (not available with 10, 22, SC, SE options)	No addition
21▲	SARGENT Construction Key System (lost ball)	\$16.00 / cyl.
22▲	SARGENT Construction Key System (split key)	\$32.00 / cyl.
23	Locksets with flat 4-7/8" ANSI strike	No addition
31	Thick Doors - Extended Lip Required - Specify Length C to E - Cylinders - IMPORTANT- See catalog 7800/8200 option page for cylinder limitations - Below charges DO NOT include additional charges for special cylinder requirements	
	Doors up to 2-1/2" thick - lock centered	No addition
	Doors 2-5/8" to 6" thick OR doors 1-3/4" thick w/max 1" paneling one side. For example: Specify 1-3/4" door with panel (Side) on inside or outside	Non Keyed function \$50.00 Keyed function \$100.00
36	6 Lobe security head screws	\$24.00
37	Spanner head screws	\$17.00
F182▲	SARGENT Keso Security Cylinder – patented – new key systems	\$91.00 / cyl.
82▲	SARGENT Keso Security Cylinder (For existing systems only)	\$91.00 / cyl.
85	Tactile Warning - Abrasive Coating on Inside Knob	\$49.00
86	Tactile Warning - Abrasive Coating on Outside Knob	\$49.00
87	Tactile Warning - Abrasive Coating on Outside & Inside Knob	\$98.00
BR	SARGENT Bump Resistant Cylinders (N/A w/10, 22, 30, 60, 63, 64, 70, 72, 73, 737P, KESO, SC, & SE options)	\$25.00 /cyl.
LC	Less Cylinder	-\$96.00/cyl.
OBS	Open Back Strike	\$79.00
SC▲	Schlage C Keyway Cylinder, (Number 41 Cylinder Only, 0 bitted)	No addition
SE▲	Schlage E Keyway Cylinder, (Number 41 Cylinder Only, 0 bitted)	No addition
SG	MicroShield® – an antimicrobial powder coat finish	\$73.00
WBS	Wrought Box Strike	No addition

NOTES: ▲ Options not available with a standard 50 function lockout cylinder.

CPC	Clear Powder Coat over 26D/32D – 7805 x KSK x RH x 32D x CPC All orders will continue to be handled as a "special" when CPC is ordered.	\$67.00
-----	--	---------



KSK
KS Escutcheon
K Knob (1485)

USA & Canada Prices Effective May 1, 2021

Function		Finish	
		10BE/26D/BSP/WSP	03/04/09/10B/14/15/26/32/32D
Single Cyl			
7804	Storeroom or Closet		
7805	Office or Entry		
7837	Classroom	\$1,948.00	\$1,972.00
7855	Office or Entry		
7806	Storeroom or Service		
7831	Utility	\$1,979.00	\$2,003.00
7836	Closet		
Single Cyl With Deadbolt			
7824	Room Door		
7825	Dormitory or Exit		
7835	Storeroom	\$2,016.00	\$2,040.00
7843	Apartment Corridor		
7845	Dormitory or Exit		
7850	Hotel Guest Lock	\$2,055.00	\$2,079.00
Double Cyl No Deadbolt			
7816	Apartment or Exit or Public Toilet		
7817	Asylum or Institutional	\$2,071.00	\$2,095.00
7838	Classroom Security Intruder		
Double Cyl With Deadbolt			
7826	Store Door		
7839, 7840	Classroom Security Intruder	\$2,095.00	\$2,119.00
7841	Classroom Security		
7852	Institutional		
Non Keyed			
7813	Communication or Exit	\$1,760.00	\$1,784.00
7815	Passage or Closet		
7865	Privacy Bedroom or Bath (Latch)	\$1,883.00	\$1,907.00
7866	Privacy Bedroom or Bath (Deadbolt)	\$1,925.00	\$1,949.00

NOTES

Available with size #41 cylinder only. Cylinder lip sits behind escutcheon.

ML-90 MORTISE LOCKS

SARGENT®

ASSA ABLOY

OPTIONS

USA & Canada Prices Effective May 1, 2021

Options	Description	Price
1▲	7800 Line with 1-1/16" wide front for 1-3/8" doors.	\$62.00
10▲	SARGENT Signature Key System	\$63.00 / cyl.
11†▲	SARGENT XC Key System (not available with 10, 22, SC, SE options)	No addition
1160	SARGENT XC Large Format Interchangeable Plastic Disposable Construction Core	No addition
1163	SARGENT XC Large Format Interchangeable Core Cylinder - Includes masterkeying charges	\$83.00
1164	SARGENT XC Large Format Interchangeable Construction Core Cylinder	\$83.00
1170	Small Format interchangeable disposable construction core - to accept 7 Pin XC permanent core	No addition
11727P	Small Format interchangeable keyed construction core - to accept 7 Pin XC permanent core	\$75.00
11737P	Small Format interchangeable core - to accept 7 pin XC permanent core	\$75.00 / cyl.
21▲†	SARGENT Construction Key System (lost ball) Standard on all new systems established since 5/1/96	\$16.00 / cyl.
22▲†	SARGENT Construction Key System (split key) To be used on pre-established split key systems only	\$32.00 / cyl.
23	Locksets with flat 4-7/8" ANSI strike	No addition
31	Thick Doors - Extended Lip Required - Specify Length C to E - Cylinders - IMPORTANT- See catalog 7800/8200 option page for cylinder limitations - Below charges DO NOT include additional charges for special cylinder requirements Doors up to 2-1/2" thick - lock centered Doors 2-5/8" to 6" thick OR doors 1-3/4" thick w/max 1" paneling one side. For example: Specify 1-3/4" door with panel (Side) on inside or outside	No addition Non Keyed function \$50.00 Keyed function \$100.00
36	6 Lobe security head screws	\$24.00
37	Spanner head screws	\$17.00
60	SARGENT Large Format Interchangeable Plastic Disposable Construction Core	No addition
63	SARGENT Large Format Interchangeable core cylinder, includes master keying charges	\$83.00 / cyl.
64	SARGENT Large Format Interchangeable Construction Core Cylinder	\$83.00
6573▲†	Small Format 6-Pin Uncombined Core (Refer to CK-12)	\$65.00 / cyl.
65737P▲†	Small Format 7-Pin Uncombined Core (Refer to CK-12)	\$65.00 / cyl.
70▲†	Small Format Interchangeable disposable plastic construction core	No addition
72▲†	Small Format Interchangeable 6-pin construction core (7-pin with 11 option)	\$75.00
73▲†	Small Format interchangeable core 6-pin Includes MK and GMK keying charges	\$75.00 / cyl
737P▲†	Small Format interchangeable core 7-pin (refer to CK-12 for available keyways) Includes MK and GMK keying charges	\$75.00 / cyl
74	Lock case wrapped in lead – handing required (roses not available)	\$294.00
81▲†	Cylinder to accept Keso (83) and Keso F1 (F183) removable core – no core provided	No addition
F182†	SARGENT Keso Security Cylinder – patented – new key systems	\$91.00 / cyl.
F183▲†	SARGENT Keso Security Removable Core Cylinder – patented – new key systems	\$130.00 / cyl.
82†	SARGENT Keso Security Cylinder (For existing systems only)	\$91.00 / cyl.
83▲†	SARGENT Keso Security Removable Core Cylinder (For existing systems only)	\$130.00 / cyl.
84▲†	SARGENT Keso Security Removable Construction Core Cylinder	See CK-18
AV	Anti Vandal Pull Trim (available in 32D finish)	\$229.00
BR	SARGENT Bump Resistant Cylinders (N/A w/10, 22, 30, 60, 63, 64, 70, 72, 73, 737P, KESO, SC, & SE options)	\$25.00 /cyl.
DG1	Patented Degree DG1 Key System	No addition
DG160	Hardware prepared for DG1-6300 Lg. Format IC cores, supplied with temporary plastic construction cores	No addition
DG163	Patented Degree DG1 Large Format Interchangeable Core Cylinder - Includes master keying charges	\$83.00
DG164	Hardware prepared for DG1-6300 Lg. Format IC cores, supplied with temporary keyed construction cores	\$83.00
DG2	Patented Degree DG2 Key System incorporating a locking sidebar	\$63.00/cyl.
DG260	Hardware prepared for DG2-6300 Lg. Format IC cores, supplied with temporary plastic construction cores	No addition
DG263	Patented Degree DG2 Large Format Interchangeable Core Cylinder - Includes master keying charges	\$146.00
DG264	Hardware prepared for DG2-6300 Lg. Format IC cores, supplied with temporary keyed construction cores	\$83.00
DG3	Patented Degree DG3 Key System incorporating a locking sidebar and UL437 listed	\$89.00/cyl.
DG360	Hardware prepared for DG3-6300 Lg. Format IC cores, supplied with temporary plastic construction cores	No addition
DG363	Patented Degree DG3 Large Format Interchangeable Core Cylinder - Includes master keying charges	\$172.00
DG364	Hardware prepared for DG3-6300 Lg. Format IC cores, supplied with temporary keyed construction cores	\$83.00
DX	Deadbolt Monitoring (not available with 50, 74)	\$197.00
LC	Less Cylinder	-\$96.00/cyl.
OBS	Open Back Strike	\$79.00
SC▲†	Schlage "C" Keyway cylinder, (Number 41 Cylinder Only, 0-bitted)	No Addition
SE▲†	Schlage "E" Keyway cylinder, (Number 41 Cylinder Only, 0-bitted)	No Addition
SG	MicroShield® – an antimicrobial powder coat finish	\$73.00
WBS	Wrought Box Strike	No Addition

NOTES: ▲ Options not available with a standard 50 function lockout cylinder. † Not available with 60, 63, 64 options.

CPC	Clear Powder Coat over 26D/32D – 7805 x SLD x RH x 32D x CPC All orders will continue to be handled as a "special" when CPC is ordered.	\$67.00
-----	--	---------

Experience a safer
and more open world

Copyright © 2002-2021 Sargent Manufacturing Company, an ASSA ABLOY Group company. All rights reserved.
Reproduction in whole or in part without the express written permission of Sargent Manufacturing Company is prohibited.
Contact us at: 800-727-5477 or visit www.sargentlock.com. In Canada contact us at: 800-461-3007 or visit www.assaabloydss.ca

USA & Canada Prices Effective May 1, 2021



SLD
SL- Rose • D Knob

NOTE: Not ADA Compliant.

Function	Finish
Single Cyl	32D
7804 Storeroom or Closet	
7805 Office or Entry	
7837 Classroom	\$2,206.00
7855 Office or Entry	
7806 Storeroom or Service	
7831 Utility	
7836 Closet	\$2,229.00
7856 Office or Inner Entry	
7857, 7858, 7867 Institutional Privacy	
Single Cyl With Deadbolt	
7824 Room Door	
7825 Dormitory or Exit	
7827 Closet or Storeroom	
7828, 7830 Dummy Trim Deadlock	
7835 Storeroom	\$2,258.00
7843 Apartment Corridor	
7845 Dormitory or Exit	
7847 Front Door or Apartment Corridor	
7851 Storeroom Deadbolt	
7850 Hotel Guest Lock	\$2,300.00
Double Cyl No Deadbolt	
7816 Apartment or Exit or Public Toilet	
7817 Asylum or Institutional	\$2,309.00
7838 Classroom Security Intruder	
Double Cyl With Deadbolt	
7826 Store Door	
7829 Dummy Trim Deadlock	
7839, 7840 Classroom Security Intruder	
7841 Classroom Security	\$2,335.00
7846 Dormitory or Exit	
7848 Store Door	
7852 Institutional	
Non Keyed	
7813 Communication or Exit	\$2,028.00
7815 Passage or Closet	
7865 Privacy Bedroom or Bath (Latch)	\$2,143.00
7866, 7868 Privacy Bedroom or Bath (Deadbolt)	\$2,178.00
7893 Single Dummy Trim	\$918.00
7894 Double Dummy Trim	\$1,837.00
7895 Single Dummy Trim w/Lockbody	\$1,024.00
7896 Double Dummy Trim w/Lockbody	\$1,940.00
7897 Double Dummy w/Active Trim	\$2,028.00

ML-92 MORTISE LOCKS

8200 DEADLOCKS

USA & Canada Prices Effective May 1, 2021

SARGENT®

ASSA ABLOY



8200
Mortise Deadlock

Function		Finish	
Single Cylinder Deadbolt		10BE/26D/BSP/WSP	03/04/09/10/10B/10BL/14/15/20D/26/32/32D
8203	Cylinder x thumbturn	\$531.00	\$491.00
8220	Cylinder	\$460.00	\$483.00
8221	Cylinder x thumbturn	\$531.00	\$555.00
Double Cylinder Deadbolt			
8222	Cylinder	\$560.00	\$579.00
8223	Cylinder x thumbturn	\$631.00	\$651.00

Double Cylinder All-Purpose Lock with 126 T-Turn Inside		Finish	
		10BE/26D/BSP/WSP	03/04/09/10/10B/10BL/14/15/20D/26/32/32D
*7892 x SSTT		\$938.00	\$944.00

Options Available:

1, 10, 11, 21, 22, 23, 31, 36, 37, 51, 52, 60, 63, 64, 65-73, 65-73-7P,
70, 72, 73, 73-7P, 74, 81, F182, F183, 82, 83, 84, DX, LC, SC, SE, SG, WBS

Please note: not all options are compatible. refer to 7800/8200 catalog option page.

*Please note: 126 T-Turn (SSTT) is only available for use with 7892 function.

DISTRIBUTOR BULK PACK PROGRAM

USA & Canada Prices Effective May 1, 2021

Features of the SARGENT Distributor Bulk Pack Program

- Allows the distributor to virtually “build your own” SARGENT mortise locks by stocking bulk packed lock bodies, complete trim sets and cylinders separately for maximum utilization of warehouse space and inventory dollars
- The 3 components fit snugly in specially designed packaging for ease in picking and maximum protection
- List price of the components equals that of a complete mortise lock. Standard Buying Program discounts apply

Using the SARGENT Distributor Bulk Pack Program

- Lockbodies must be ordered in multiples of 10 per function/finish. Option BP- to lock function in order to receive bulk packaging and bulk pack program pricing. Strike and o/s front are included, please specify finish. The lock bodies are individually pack aged in with strike and o/s front in protective sleeves. Packed 10 per carton.
- Complete trim sets must be ordered in multiples of 10 per design/finish. These are individually packaged in full mortise lock boxes and are packed 10 per carton.
- Order cylinders as a separate line item if required.

Product functions available

Function	Description	ANSI
7804/8204	Storeroom	F07
7805/8205	Office	F04
7837/8237	Classroom	F05
7824/8224	Storeroom	F21
7825/8225	Dormitory	F13
7843/8243	Dwelling Entry	F20
7845/8245	Dwelling Entry	F12
7815/8215	Passage	F01
7865/8265	Privacy	F22

How to Order/Notes: Example: BP-8225 x US3

- 1) Distributor Bulk Pack lockbodies must be ordered with BP option.
- 2) Distributor Bulk Pack lockbodies must be ordered in multiples of **10 per each lock function.** (Quantity of 1 = 1 lockbody; Packed 10 to a box)
- 3) Orders received for less than case quantities will be priced at non-bulk pack prices.
- 4) Distributor Bulk Pack lockbodies **DO NOT** include cylinder and trim sets.
- 5) Distributor Bulk Pack lockbodies **include** outside front, strike, and mounting screws.

Designs and Finishes Available

ALL current 7800/8200 trim designs and finishes will be offered within the SARGENT Distributor Bulk Pack.

How to Order/Notes: Example: TR-8225 LE1P x US3 x RH

- 1) Distributor Bulk Pack trim sets must be ordered: using TR(option) x lock function x trim design x finish x hand (A lever and Escutcheon trim are handed. Please specify hand when ordering).
- 2) Distributor Bulk Pack trim sets must be ordered in multiples of **10 per** design and finish. (Quantity of 1 - 1 trim set; packed 10 to a box)
- 3) Orders received for less than case quantities will be priced at non-bulk pack prices.
- 4) Complete trim sets include spindles, trim pack assemblies, instruction sheets, and templates.
- 5) Split designs and or finishes are not available.
- 6) Components are for 1-3/4" thick doors only.
- 7) Cylinder and lockbodies must be ordered separately.

*Note: “A” lever design and all escutcheon designs are handed. **Please specify hand when ordering.**

ML-94 MORTISE LOCKS

SARGENT®

ASSA ABLOY

DISTRIBUTOR BULK PACK PROGRAM

USA & Canada Prices Effective May 1, 2021

NOTE: Quantity 1 each = 1 lockbody; must be ordered in multiples of 10 each per each lock function

Lockbody ONLY Example: BP-8225 x US3

8200 Lockbody Single Cylinder Function		All Finishes
BP-8204	Storeroom	\$435.00
BP-8205	Office	\$435.00
BP-8237	Classroom	\$435.00
BP-8255	Office	\$435.00

Single Cylinder Function with Deadbolt		
BP-8224	Storeroom	\$460.00
BP-8225	Dormitory	\$460.00
BP-8243	Dwelling Entry	\$460.00
BP-8245	Dwelling Entry	\$460.00

Non-Keyed		
BP-8215	Passage	\$364.00
BP-8265	Privacy	\$409.00

7800 Lockbody Single Cylinder Function		All Finishes
BP-7804	Storeroom	\$422.00
BP-7805	Office	\$422.00
BP-7837	Classroom	\$422.00

Single Cylinder Function with Deadbolt		
BP-7824	Storeroom	\$452.00
BP-7825	Dormitory	\$452.00
BP-7843	Dwelling Entry	\$452.00
BP-7845	Dwelling Entry	\$452.00

Non-Keyed		
BP-7815	Passage	\$350.00
BP-7865	Privacy	\$399.00

Experience a safer
and more open world

Copyright © 2002-2021 Sargent Manufacturing Company, an ASSA ABLOY Group company. All rights reserved.
Reproduction in whole or in part without the express written permission of Sargent Manufacturing Company is prohibited.
Contact us at: 800-727-5477 or visit www.sargentlock.com. In Canada contact us at: 800-461-3007 or visit www.assaabloydss.ca

USA & Canada Prices Effective May 1, 2021

Quantity 1 each = 1 lockbody set of trim; must be ordered in multiples of 10 each per design and finish.
TRIM ONLY. Lockbodies and cylinders NOT included. Example: TR-8225 LE1P x 03 x RH

Lock Function	Rose	Lever	10BE/26D/BSP/WSP	03/04/09/10/10B/10BL/14/15/20D/26/32/32D
TR-8204/8205/8237/8255	E, L, LN, O	*A, E, F, W	\$573.00	\$604.00
	E, L, LN, O	B, L, P	\$533.00	\$569.00 Set
	E, L, LN, O	J	\$378.00	\$416.00
TR-8224/8225/8243/8245	E, L, LN, O	*A, E, F, W	\$602.00	\$631.00
	E, L, LN, O	B, L, P	\$559.00	\$599.00 Set
	E, L, LN, O	J	\$404.00	\$443.00
TR-8215	E, L, LN, O	*A, E, F, W	\$560.00	\$594.00
	E, L, LN, O	B, L, P	\$518.00	\$555.00 Set
	E, L, LN, O	J	\$362.00	\$408.00
TR-8265	E, L, LN, O	*A, E, F, W	\$627.00	\$659.00
	E, L, LN, O	B, L, P	\$586.00	\$624.00 Set
	E, L, LN, O	J	\$434.00	\$475.00

Lock Function	*Escutcheon	Lever	10BE/26D/BSP/WSP	03/04/09/10/10B/10BL/14/15/20D/26/32/32D
TR-8204/8205/8237/8255	*LE1	A thru W	\$612.00	\$652.00
TR-8224/8225/8243/8245	*LE1	A thru W	\$644.00	\$680.00 Set
TR-8215	*LE1	A thru W	\$604.00	\$644.00
TR-8265	*LE1	A thru W	\$676.00	\$709.00

Add to LE1 prices above:

Standard Cylinder	*LE2	x concealed mounting		\$32.00
Non-Keyed Function	*LE2	x concealed mounting		\$32.00
Cylinder Barrel Only	*LE3	x exposed screws (not avail. in double cyl. functions)		\$91.00 Set
Non-Keyed Function	*LE3	x exposed screws		\$32.00
Cylinder Barrel Only	*LE4	x concealed mounting (not avail. in double cyl. functions)		\$101.00
Non-Keyed Function	*LE4	x concealed mounting		\$32.00

Lock Function	*Escutcheon	Lever	10BE/26D/BSP/WSP	03/04/09/10/10B/10BL/14/15/20D/26/32/32D
TR-8204/8205/8237/8255	*LW1	A thru W	\$557.00	\$598.00
TR-8224/8225/8243/8245	*LW1	A thru W	\$588.00	\$623.00 Set
TR-8215	*LW1	A thru W	\$548.00	\$579.00
TR-8265	*LW1	A thru W	\$611.00	\$651.00
TR-8204/8205/8237/8255	*WT	A thru W	\$523.00	\$564.00
TR-8224/8225/8243/8245	*WT	A thru W	\$555.00	\$588.00 Set
TR-8215	*WT	A thru W	\$515.00	\$551.00
TR-8265	*WT	A thru W	\$579.00	\$618.00
TR-8204/8205/8237/8255	*LS	A thru W	\$1,123.00	\$1,154.00
TR-8224/8225/8243/8245	*LS	A thru W	\$1,154.00	\$1,180.00 Set
TR-8215	*LS	A thru W	\$1,114.00	\$1,138.00
TR-8265	*LS	A thru W	\$1,183.00	\$1,204.00

Lock Function	*Escutcheon	Lever	10BE/26D/BSP/WSP	03/04/09/10/10B/10BL/14/15/20D/26
TR-8204/8205/8237/8255	*FE	A*, B, E, F, J, L, P, W	\$743.00	\$776.00
TR-8224/8225	*FE	A*, B, E, F, J, L, P, W	\$772.00	\$805.00 Set
TR-8265	*FE	A*, B, E, F, J, L, P, W	\$797.00	\$827.00

*Note: "A" lever design and all escutcheon designs are handed. **Please specify hand when ordering.**

ML-96 MORTISE LOCKS

SARGENT®

DISTRIBUTOR BULK PACK PROGRAM 8200 COASTAL SERIES TRIM & 7800 SERIES

ASSA ABLOY

USA & Canada Prices Effective May 1, 2021

Quantity 1 each = 1 set of trim; must be ordered in multiples of 10 each per design and finish.

TRIM ONLY. Lockbodies and cylinders NOT included.

How to Order – Example: TR-8205 CRY x 03 x RH

Lock Function	Rose	Lever	10BE/26DBSP/WSP	03/04/09/10/10B/10BL/14/15/20D/26
TR-8204/8205/8237/8255	TR, CR	G*, R, S*, Y*	\$573.00	\$604.00
TR-8224/8225/8243/8245	TR, CR	G*, R, S*, Y*	\$602.00	\$631.00
TR-8215	TR, CR	G*, R, S*, Y*	\$560.00	\$594.00
TR-8265	TR, CR	G*, R, S*, Y*	\$627.00	\$659.00

Lock Function	*Escutcheon	Lever	10BE/26DBSP/WSP	03/04/09/10/10B/10BL/14/15/20D/26
TR-8204/8205/8237/8255	TE, CE	G*, R, S*, Y*	\$594.00	\$635.00
TR-8224/8225/8243/78245	TE, CE	G*, R, S*, Y*	\$626.00	\$659.00
TR-8215	TE, CE	G*, R, S*, Y*	\$586.00	\$626.00
TR-8265	TE, CE	G*, R, S*, Y*	\$656.00	\$688.00

Lock Function	Rose	Lever	10BE/26DBSP/WSP	03/04/09/10/10B/10BL/14/15/20D/26/32/32D
TR-8204/8205/8237/8255			\$573.00	\$604.00
TR-8224/8225/8243/78245	O, CO, CR, LN, TO, TR x		\$602.00	\$631.00
TR-8215	All Studio Collection Levers (Except Gramercy Series)		\$560.00	\$594.00
TR-8265			\$627.00	\$659.00

Lock Function	Rose	Lever	10BE/26DBSP/WSP	03/04/09/10/10B/10BL/14/15/20D/26/32/32D
TR-8204/8205/8237/8255			\$594.00	\$635.00
TR-8224/8225/8243/78245	CE, TE, LE1 x		\$626.00	\$659.00
TR-8215	All Studio Collection Levers (Except Gramercy Series)		\$586.00	\$626.00
TR-8265			\$656.00	\$688.00

Lock Function	Rose	Knob	10BE/26DBSP/WSP	03/04/09/10/10B/10BL/14/15/20D/26/32/32D
TR-7804/7805/7837/7855	O, E, L	B, C	\$607.00	\$643.00
TR-7824/7825/7843/7845	O, E, L	B, C	\$634.00	\$669.00
TR-7815	O, E, L	B, C	\$583.00	\$617.00
TR-7865	O, E, L	B, C	\$656.00	\$689.00

Lock Function	*Escutcheon Knob	10BE/26DBSP/WSP	03/04/09/10/10B/10BL/14/15/20D/26/32/32D
TR-7804/7805/7837/7855	*WT B, C	\$648.00	\$689.00
TR-7824/7825/7843/7845	*WT B, C	\$677.00	\$712.00
TR-7815	*WT B, C	\$623.00	\$659.00
TR-7865	*WT B, C	\$695.00	\$738.00

Lock Function	*Escutcheon Knob	10BE/26DBSP/WSP	03/04/09/10/10B/10BL/14/15/20D/26/32/32D
TR-7804/7805/7837/7855	*KW1 B, C	\$717.00	\$749.00
TR-7824/7825/7843/7845	*KW1 B, C	\$746.00	\$783.00
TR-7815	*KW1 B, C	\$692.00	\$725.00
TR-7865	*KW1 B, C	\$765.00	\$801.00

Lock Function	*Escutcheon Knob	10BE/26DBSP/WSP	03/04/09/10/10B/10BL/14/15/20D/26/32/32D
TR-7804/7805/7837/7855	*KE1 B, C	\$834.00	\$869.00
TR-7824/7825/7843/7845	*KE1 B, C	\$860.00	\$896.00
TR-7815	*KE1 B, C	\$806.00	\$841.00
TR-7865	*KE1 B, C	\$879.00	\$916.00

			Add to KE1 prices above:
Standard Cylinder	*KE2	x concealed mounting.	\$32.00
Non-Keyed Function	*KE2	x concealed mounting	\$32.00
Cylinder Barrel Only	*KE3	x exposed screws (not avail. in double cyl. functions)	\$91.00
Non-Keyed Function	*KE3	x exposed screws	\$32.00
Cylinder Barrel Only	*KE4	x concealed mounting (not avail. in double cyl. functions)	\$101.00
Non-Keyed Function	*KE4	x concealed mounting	\$32.00

Lock Function	*Escutcheon Knob	10BE/26DBSP/WSP	03/04/09/10/10B/14/15/26/32/32D
TR-7804/7805/7837/7855	*KS K	\$1,444.00	\$1,484.00
TR-7824/7825/7843/7845	*KS K	\$1,471.00	\$1,506.00
TR-7815	*KS K	\$1,419.00	\$1,461.00
TR-7865	*KS K	\$1,495.00	\$1,529.00

*Note: All escutcheon designs are handed. G, S, Y lever designs are handed. Please specify hand when ordering.

Experience a safer
and more open world

Copyright © 2002-2021 Sargent Manufacturing Company, an ASSA ABLOY Group company. All rights reserved.
Reproduction in whole or in part without the express written permission of Sargent Manufacturing Company is prohibited.
Contact us at: 800-727-5477 or visit www.sargentlock.com. In Canada contact us at: 800-461-3007 or visit www.assaabloydss.ca

7800/8200/R8200 Lock Bodies Only		All Finishes		
Function		7800	8200	R8200
Single Cyl	Function Description			
04	Storeroom or Closet			
05	Office or Entry			
37	Classroom			
06	Storeroom or Service	\$556.00	\$588.00	\$623.00
31	Utility			
36	Closet			
55	Office or Entry			
56	Office or Inner Entry	\$582.00	\$611.00	\$648.00
57, 58, 67	Institutional Privacy			
89	Holdback	N/A	\$611.00	N/A
91(8291)	All Purpose Holdback			
Single Cyl With Deadbolt				
24	Room Door			
25	Dormitory or Exit			
27	Closet or Storeroom			
28, 30	Dummy Trim Deadlock			
35	Storeroom	\$608.00	\$635.00	\$673.00
43	Apartment Corridor			
45	Dormitory or Exit			
47	Front Door or Apartment Corridor			
51	Storeroom Deadbolt			
50	Hotel Guest Lock	\$608.00	\$635.00	\$673.00
Double Cyl No Deadbolt				
16	Apartment or Exit or Public Toilet			
17	Asylum or Institutional			
38	Classroom Security Intruder	\$556.00	\$588.00	\$623.00
59	School Security			
90	Classroom Security Holdback	N/A	\$588.00	N/A
92	All Purpose Holdback	\$556.00	\$588.00	N/A
Double Cyl With Deadbolt				
26	Store Door			
29	Dummy Trim Deadlock			
39	Classroom Security Intruder			
40	Classroom Security Intruder			
41	Classroom Security	\$608.00	\$635.00	\$673.00
46	Dormitory or Exit			
48	Store Door			
49	Security			
52	Institutional			
Electro Mechanical Single Cyl – Specify 12V or 24V				
70-12V / 70-24V	Fail Safe	NA	\$970.00	\$1,028.00
71-12V / 71-24V	Fail Secure			
Electro Mechanical Double Cyl – Specify 12V or 24V				
72-12V / 72-24V	Fail Safe	NA	\$970.00	\$1,028.00
73-12V / 72-24V	Fail Secure			
Non Keyed				
13	Communication or Exit	\$556.00	\$588.00	\$623.00
15	Passage or Closet	\$398.00	\$425.00	\$451.00
65	Privacy Bedroom or Bath (Latch)	\$498.00	\$527.00	\$559.00
66	Privacy Bedroom or Bath (Deadbolt)	\$608.00	\$635.00	\$673.00
68	Privacy Bedroom or Bath (Deadbolt)	\$608.00	\$635.00	\$673.00
95	Single Dummy Trim w/Lockbody	\$398.00	\$425.00	\$451.00
96	Double Dummy Trim w/Lockbody	\$398.00	\$425.00	\$451.00
97	Double Dummy w/Active Trim	\$398.00	\$425.00	\$451.00

NOTE: Cylinder and trim not included. Outside front, strike and screwpack are included.

For 7800 "PT" Trim (Push/Pull) Lockbodies and 8200 "ALP" Trim, refer to Healthcare Hardware section.

Lockbodies with options 1, 3, 68, 69, DX, LX, RX, or any combination, please consult the factory for correct part number and price.

ML-98 MORTISE LOCKS

SARGENT®

ASSA ABLOY

8200 TRIM SET PROGRAM

USA & Canada Prices Effective May 1, 2021

Features of the NEW Sargent Mortise Trim Set Program

- Mortise Trim Set program allows a distributor to purchase a complete inside set of trim or a complete outside set of trim for Sargent's 7800 and 8200 mortise locks.
- No extra parts are required to complete the trim sets.
- All current 7800/8200 trim designs and finishes are available within the NEW Trim Set program.

How to use and order the NEW Trim Set program:

You will need to know function, trim design, finish, and hand (if required) that your trim will be used with

- For a complete inside trim set for Sargent's 8200/7800 mortise lock, use option IS.
Example: IS-8205 LNA x US3 x RH
- For a complete outside trim set for Sargent's 8200/7800 mortise lock, use option OS.
Example: OS-8205 LNA x US3 x RH

- For a complete inside and outside set of trim, you will need to order 1 IS and 1 OS trim pack.
Example: 1 ea IS-8205 LNA x US3 x RH
 1 ea OS-8205 LNA x US3 x RH

Note: Cylinders are NOT included within the trim sets. Cylinders must be ordered separately.

3 Easy steps in putting together a complete 8265 LNL x 26D lockset

EXAMPLE:

- | | | |
|-------------|--------------------------|---|
| 1. Lockbody | 1 ea 8265 x 26D | includes o/s front and strike |
| 2. I/S Trim | 1 ea IS-8265 x LNL x 26D | includes inside L lever assy., LN rose, 130KB turn lever assy, trim pack. |
| 3. O/S Trim | 1 ea OS-8265 x LNL x 26D | includes outside L lever assy., LN rose, 184W emergency release assy. |

USA & Canada Prices Effective May 1, 2021

Example: IS-8225 LNA x US3 x RH

Inside trim sets include: Inside lever, inside rose or escutcheon, trim pack (spindles, thru-bolt screws, set screw, inside adaptor plate assembly), trim finish screws (for escutcheons). CYLINDERS NOT INCLUDED – Order separately.

*Note: "A" lever design and all escutcheon designs are handed. **Please specify hand when ordering.**

Lock Function	Gramercy Series	Trim	Rose x Lever	10BE/BSP/WSP/629/630
IS-8204	IS-8215	IS-8267	IS-8291	\$365.00
IS-8205	IS-8237	IS-8270	IS-8295	
IS-8206	IS-8255	IS-8271	IS-8296	
IS-8213	IS-8256	IS-8289	IS-8297	
IS-8216	IS-8238	IS-8246	IS-8273	\$373.00
IS-8217	IS-8239	IS-8248	IS-8290	
IS-8226	IS-8240	IS-8252	IS-8292	
IS-8229	IS-8241	IS-8272		
IS-8224	IS-8230	IS-8250	IS-8268	\$398.00
IS-8225	IS-8243	IS-8251		
IS-8227	IS-8245	IS-8265		
IS-8228	IS-8247	IS-8266		

Lock Function	Gramercy Series	Trim	Rose x Lever	10BE/BSP/WSP/629/630
IS-8204	IS-8215	IS-8267	IS-8291	\$388.00
IS-8205	IS-8237	IS-8270	IS-8295	
IS-8206	IS-8255	IS-8271	IS-8296	
IS-8213	IS-8256	IS-8289	IS-8297	
IS-8216	IS-8238	IS-8246	IS-8273	\$400.00
IS-8217	IS-8239	IS-8248	IS-8290	
IS-8226	IS-8240	IS-8252	IS-8292	
IS-8229	IS-8241	IS-8272		
IS-8224	IS-8230	IS-8250	IS-8268	\$424.00
IS-8225	IS-8243	IS-8251		
IS-8227	IS-8245	IS-8265		
IS-8228	IS-8247	IS-8266		

Lock Function	Rose	Lever	10BE/26D/BSP/WSP	03/04/09/10/10B/10BL/14/15/20D/26/32/32D
IS-8204	E, L, LN, O	A*, E, F, W	\$331.00	\$345.00
IS-8205		B, L, P	\$318.00	\$337.00
IS-8206		J	\$282.00	\$299.00
IS-8213				
IS-8216	E, L, LN, O	A*, E, F, W	\$339.00	\$358.00
IS-8217		B, L, P	\$331.00	\$345.00
IS-8226		J	\$286.00	\$310.00
IS-8229				
IS-8224	E, L, LN, O	A*, E, F, W	\$371.00	\$389.00
IS-8225		B, L, P	\$359.00	\$376.00
IS-8227		J	\$322.00	\$341.00
IS-8228				

Lock Function	Coastal Trim	Rose	Lever	10BE/26D/BSP/WSP	03/04/09/10/10B/10BL/14/15/20D/26
IS-8204	TR, CR		G*, R, S*, Y*	\$331.00	\$345.00
IS-8205					
IS-8206					
IS-8213					
IS-8216	TR, CR		G*, R, S*, Y*	\$339.00	\$358.00
IS-8217					
IS-8226					
IS-8229					
IS-8224	TR, CR		G*, R, S*, Y*	\$371.00	\$389.00
IS-8225					
IS-8227					
IS-8228					

Lock Function	Studio Collection Trim	Rose x Lever	10BE/26D/BSP/WSP	03/04/09/10/10B/10BL/14/15/20D/26/32/32D	
IS-8204		E2, E3, E4, O, CO, CR, LN, TO, TR	x All Studio Collection Levers (Except Gramercy Series)	\$331.00	\$345.00
IS-8205					
IS-8206					
IS-8213					
IS-8216				\$339.00	\$358.00
IS-8217					
IS-8226					
IS-8229					
IS-8224				\$371.00	\$389.00
IS-8225					
IS-8227					
IS-8228					

ML-100 MORTISE LOCKS

SARGENT®

ASSA ABLOY

8200 INSIDE TRIM SET

USA & Canada Prices Effective May 1, 2021

Example: IS-8225 LNA x US3 x RH

Inside trim sets include: Inside lever, inside rose or escutcheon, trim pack (spindles, thrubolt screws, set screw, inside adaptor plate assembly), trim finish screws (for escutcheons). CYLINDERS NOT INCLUDED – Order separately.

*Note: "A" lever design and all escutcheon designs are handed. **Please specify hand when ordering.**

Lock Function	Studio	Collection	Trim	Roseless x Lever	10BE/26D/BSP/WSP	03/04/09/10/10B/10BL/14/15/20D/26
IS-R8204	IS-R8215	IS-R8267	IS-R8296		\$365.00	\$382.00
IS-R8205	IS-R8237	IS-R8270	IS-R8297			
IS-R8206	IS-R8255	IS-R8271	IS-R8296			
IS-R8213	IS-R8256	IS-R8295	IS-R8295			
IS-R8216	IS-R8238	IS-R8246	IS-R8273	R x G, R, S, Y	\$375.00	\$396.00
IS-R8217	IS-R8239	IS-R8248	IS-R8273			
IS-R8226	IS-R8240	IS-R8252	IS-R8273			
IS-R8229	IS-R8241	IS-R8272	IS-R8272			
IS-R8224	IS-R8230	IS-R8250	IS-R8268		\$409.00	\$432.00
IS-R8225	IS-R8243	IS-R8251	IS-R8268			
IS-R8227	IS-R8245	IS-R8265	IS-R8268			
IS-R8228	IS-R8247	IS-R8266	IS-R8266			

Lock Function	Studio	Collection	Trim	Roseless x Lever	10BE/26D/BSP/WSP	03/04/09/10/10B/10BL/14/15/20D/26/32/32D
IS-R8204	IS-R8215	IS-R8267	IS-R8296		\$365.00	\$382.00
IS-R8205	IS-R8237	IS-R8270	IS-R8297			
IS-R8206	IS-R8255	IS-R8271	IS-R8296			
IS-R8213	IS-R8256	IS-R8295	IS-R8295			
IS-R8216	IS-R8238	IS-R8246	IS-R8273	R x All Studio Collection Levers (Except Gramercy Series)	\$375.00	\$396.00
IS-R8217	IS-R8239	IS-R8248	IS-R8273			
IS-R8226	IS-R8240	IS-R8252	IS-R8273			
IS-R8229	IS-R8241	IS-R8272	IS-R8272			
IS-R8224	IS-R8230	IS-R8250	IS-R8268		\$409.00	\$432.00
IS-R8225	IS-R8243	IS-R8251	IS-R8268			
IS-R8227	IS-R8245	IS-R8265	IS-R8268			
IS-R8228	IS-R8247	IS-R8266	IS-R8266			

Lock Function	Coastal	Trim	*Esc	Lever	10BE/26D/BSP/WSP	03/04/09/10/10B/10BL/14/15/20D/26
IS-8204	IS-8215	IS-8267	IS-8291	TE, CE	\$461.00	\$477.00
IS-8205	IS-8237	IS-8270	IS-8295			
IS-8206	IS-8255	IS-8271	IS-8296			
IS-8213	IS-8256	IS-8289	IS-8297			
IS-8216	IS-8238	IS-8246	IS-8273	TE, CE	\$473.00	\$504.00
IS-8217	IS-8239	IS-8248	IS-8290			
IS-8226	IS-8240	IS-8252	IS-8292			
IS-8229	IS-8241	IS-8272	IS-8292			
IS-8224	IS-8230	IS-8250	IS-8268	TE, CE	\$502.00	\$533.00
IS-8225	IS-8243	IS-8251	IS-8268			
IS-8227	IS-8245	IS-8265	IS-8268			
IS-8228	IS-8247	IS-8266	IS-8266			

Lock Function	*Esc.	Lever	10BE/26DBSP/WSP	03/04/09/10/10B/10BL/14/15/20D/26/32/32D
IS-8204	IS-8215	IS-8267	IS-8291	*LW1
IS-8205	IS-8237	IS-8270	IS-8295	
IS-8206	IS-8255	IS-8271	IS-8296	
IS-8213	IS-8256	IS-8289	IS-8297	
IS-8216	IS-8238	IS-8246	IS-8273	*LW1
IS-8217	IS-8239	IS-8248	IS-8290	
IS-8226	IS-8240	IS-8252	IS-8292	
IS-8229	IS-8241	IS-8272	IS-8292	
IS-8224	IS-8230	IS-8250	IS-8268	*LW1
IS-8225	IS-8243	IS-8251	IS-8268	
IS-8227	IS-8245	IS-8265	IS-8268	
IS-8228	IS-8247	IS-8266	IS-8266	

Lock Function	Studio	Collection	Trim	Escutcheon x Lever	10BE/26D/BSP/WSP	03/04/09/10/10B/10BL/14/15/20D/26/32/32D
IS-8204	IS-8215	IS-8267	IS-8291		\$461.00	\$477.00
IS-8205	IS-8237	IS-8270	IS-8295			
IS-8206	IS-8255	IS-8271	IS-8296			
IS-8213	IS-8256	IS-8289	IS-8297			
IS-8216	IS-8238	IS-8246	IS-8273	CE, TE, LE1 x All Studio Collection levers (Except Gramercy Series)	\$473.00	\$504.00
IS-8217	IS-8239	IS-8248	IS-8290			
IS-8226	IS-8240	IS-8252	IS-8292			
IS-8229	IS-8241	IS-8272	IS-8292			
IS-8224	IS-8230	IS-8250	IS-8268		\$502.00	\$533.00
IS-8225	IS-8243	IS-8251	IS-8268			
IS-8227	IS-8245	IS-8265	IS-8268			
IS-8228	IS-8247	IS-8266	IS-8266			

Experience a safer
and more open world

Copyright © 2002-2021 Sargent Manufacturing Company, an ASSA ABLOY Group company. All rights reserved.
Reproduction in whole or in part without the express written permission of Sargent Manufacturing Company is prohibited.
Contact us at: 800-727-5477 or visit www.sargentlock.com. In Canada contact us at: 800-461-3007 or visit www.assaabloydss.ca

USA & Canada Prices Effective May 1, 2021

Example: IS-8225 WTP x US3 x RH

Inside trim sets include: Inside lever, inside rose or escutcheon, trim pack (spindles, thru-bolt screws, set screw, inside adaptor plate assembly), trim finish screws (for escutcheons). CYLINDERS NOT INCLUDED – Order separately.

*Note: "A" lever design and all escutcheon designs are handed. **Please specify hand when ordering.**

Lock Function	Gramercy Series	Trim	Esc. x Lever	10BE/BSP/WSP/629/630
IS-8204	IS-8215	IS-8267	IS-8291	\$396.00
IS-8205	IS-8237	IS-8270	IS-8295	
IS-8206	IS-8255	IS-8271	IS-8296	
IS-8213	IS-8256	IS-8289	IS-8297	
IS-8216	IS-8238	IS-8246	IS-8273	\$403.00
IS-8217	IS-8239	IS-8248	IS-8290	
IS-8226	IS-8240	IS-8252	IS-8292	
IS-8229	IS-8241	IS-8272		
IS-8224	IS-8230	IS-8250	IS-8268	\$430.00
IS-8225	IS-8243	IS-8251		
IS-8227	IS-8245	IS-8265		
IS-8228	IS-8247	IS-8266		

Lock Function	Gramercy Series	Trim	Esc. x Lever	10BE/BSP/WSP/629/630
IS-8204	IS-8215	IS-8267	IS-8291	\$418.00
IS-8205	IS-8237	IS-8270	IS-8295	
IS-8206	IS-8255	IS-8271	IS-8296	
IS-8213	IS-8256	IS-8289	IS-8297	
IS-8216	IS-8238	IS-8246	IS-8273	\$430.00
IS-8217	IS-8239	IS-8248	IS-8290	
IS-8226	IS-8240	IS-8252	IS-8292	
IS-8229	IS-8241	IS-8272		
IS-8224	IS-8230	IS-8250	IS-8268	\$452.00
IS-8225	IS-8243	IS-8251		
IS-8227	IS-8245	IS-8265		
IS-8228	IS-8247	IS-8266		

Lock Function	*Esc.	Lever	10BE/26D/BSP/WSP	03/04/09/10/10B/10BL/14/15/20D/26/32/32D
IS-8204	IS-8215	IS-8267	IS-8291	\$477.00
IS-8205	IS-8237	IS-8270	IS-8295	
IS-8206	IS-8255	IS-8271	IS-8296	
IS-8213	IS-8256	IS-8289	IS-8297	
IS-8216	IS-8238	IS-8246	IS-8273	\$484.00
IS-8217	IS-8239	IS-8248	IS-8290	
IS-8226	IS-8240	IS-8252	IS-8292	
IS-8229	IS-8241	IS-8272		
IS-8224	IS-8230	IS-8250	IS-8268	\$514.00
IS-8225	IS-8243	IS-8251		
IS-8227	IS-8245	IS-8265		
IS-8228	IS-8247	IS-8266		

Lock Function	*Esc.	Lever	Add to LE1 prices above:
Standard Cylinder x concealed mounting	*LE2	*A, B, E, F, J, L, P, W	\$16.00
Non-Keyed Function x concealed mounting	*LE2	L, P, W	\$16.00
Cylinder Barrel x exposed screws	*LE3	*A, B, E, F, J, L, P, W	\$46.00
Non-Keyed Function x exposed screws	*LE3	L, P, W	\$16.00
Cylinder Barrel only x concealed mounting	*LE4	*A, B, E, F, J, L, P, W	\$51.00
Non-Keyed Function x concealed mounting	*LE4	L, P, W	\$16.00

Note: LE3, LE4 not available w/double cylinder functions

Lock Function	*Esc.	Lever	10BE/26D/BSP/WSP	03/04/09/10/10B/10BL/14/15/20D/26/32/32D
IS-8204	IS-8215	IS-8267	IS-8291	\$424.00
IS-8205	IS-8237	IS-8270	IS-8295	
IS-8206	IS-8255	IS-8271	IS-8296	
IS-8213	IS-8256	IS-8289	IS-8297	
IS-8216	IS-8238	IS-8246	IS-8273	\$433.00
IS-8217	IS-8239	IS-8248	IS-8290	
IS-8226	IS-8240	IS-8252	IS-8292	
IS-8229	IS-8241	IS-8272		
IS-8224	IS-8230	IS-8250	IS-8268	\$463.00
IS-8225	IS-8243	IS-8251		
IS-8227	IS-8245	IS-8265		
IS-8228	IS-8247	IS-8266		

ML-102 MORTISE LOCKS

SARGENT®

ASSA ABLOY

8200 INSIDE TRIM SET

USA & Canada Prices Effective May 1, 2021

Example: IS-8225 WTP x US3 x RH

Inside trim sets include: Inside lever, inside rose or escutcheon, trim pack (spindles, thrubolt screws, set screw, inside adaptor plate assembly), trim finish screws (for escutcheons). CYLINDERS NOT INCLUDED – Order separately.

*Note: "A" lever design and all escutcheon designs are handed. **Please specify hand when ordering.**

Lock Function	*Esc.	Lever	10BE/26D/BSP/WSP	03/04/09/10/10B/10BL/14/15/20D/26/32/32D
IS-8204 IS-8206 IS-8215 IS-8205 IS-8213 IS-8237	*LS	*A, B, E, F, J, L, P, W	\$696.00	\$708.00
IS-8216 IS-8226 IS-8239 IS-8241 IS-8217 IS-8238 IS-8240	*LS	*A, B, E, F, J, L, P, W	\$706.00	\$715.00
IS-8224 IS-8243 IS-8250 IS-8266 IS-8225 IS-8245 IS-8265	*LS	*A, B, E, F, J, L, P, W	\$734.00	\$745.00

Lock Function	*Esc.	Lever	10BE/26D/BSP/WSP	03/04/09/10/10B/10BL/14/15/20D/26
IS-8204 IS-8237 IS-8205	*FE	*A, B, E, F, J, L, P, W	\$501.00	\$518.00
IS-8216 IS-8226 IS-8239 IS-8217 IS-8238 IS-8240	*FE	*A, B, E, F, J, L, P, W	\$511.00	\$527.00
IS-8224 IS-8251 IS-8266	*FE	*A, B, E, F, J, L, P, W	\$542.00	\$553.00

8200 OUTSIDE TRIM SET

Example: OS-8225 LE1P x US3 x RH

Outside trim sets include: Outside lever, outside rose or escutcheon, outside mounting plate, two thrubolt studs, washers, retaining nut, and cylinder rosettes (for cylinder functions only). CYLINDERS NOT INCLUDED – Order separately.

*Note: "A" lever design and all escutcheon designs are handed. **Please specify hand when ordering.**

Lock Function	Rose	Lever	10BE/26D/BSP/WSP	03/04/09/10/10B/10BL/14/15/20D/26/32/32D
OS-8204 OS-8229 OS-8241 OS-8255 OS-8205 OS-8230 OS-8243 OS-8256 OS-8216 OS-8231 OS-8245 OS-8267 OS-8217 OS-8235 OS-8246 OS-8270 OS-8224 OS-8236 OS-8247 OS-8271 OS-8225 OS-8237 OS-8248 OS-8272 OS-8226 OS-8238 OS-8250 OS-8273 OS-8227 OS-8239 OS-8251 OS-8289 OS-8228 OS-8240 OS-8252	E, L, LN, O	A*, E, F, W	\$353.00	\$371.00
		B, L, P	\$341.00	\$359.00
		J	\$301.00	\$318.00
OS-8215 OS-8294 OS-8296 OS-8297	E, L, LN, O	A*, E, F, W	\$341.00	\$361.00
		B, L, P	\$333.00	\$346.00
		J	\$286.00	\$310.00
OS-8265 OS-8266 OS-8268	E, L, LN, O	A*, E, F, W	\$373.00	\$395.00
		B, L, P	\$361.00	\$377.00
		J	\$322.00	\$341.00

Lock Function Coastal Trim	Rose	Lever	10EE/26D/BSP/WSP	03/04/09/10/10B/10BL/14/15/20D/26	
OS-8204 OS-8229 OS-8241 OS-8255 OS-8205 OS-8230 OS-8243 OS-8256 OS-8216 OS-8231 OS-8245 OS-8267 OS-8217 OS-8235 OS-8246 OS-8270 OS-8224 OS-8236 OS-8247 OS-8271 OS-8225 OS-8237 OS-8248 OS-8272 OS-8226 OS-8238 OS-8250 OS-8273 OS-8227 OS-8239 OS-8251 OS-8289 OS-8228 OS-8240 OS-8252	TR, CR	G*, R, S*, Y*	\$353.00	\$371.00	
OS-8215 OS-8294 OS-8296 OS-8297		TR, CR	G*, R, S*, Y*	\$341.00	\$361.00
OS-8265 OS-8266 OS-8268		TR, CR	G*, R, S*, Y*	\$373.00	\$395.00

Lock Function Studio Collection Trim	Rose	Lever	10BE/26D/BSP/WSP	03/04/09/10/10B/10BL/14/15/20D/26/32/32D
OS-8204 OS-8229 OS-8241 OS-8255 OS-8205 OS-8230 OS-8243 OS-8256 OS-8216 OS-8231 OS-8245 OS-8267 OS-8217 OS-8235 OS-8246 OS-8270 OS-8224 OS-8236 OS-8247 OS-8271 OS-8225 OS-8237 OS-8248 OS-8272 OS-8226 OS-8238 OS-8250 OS-8273 OS-8227 OS-8239 OS-8251 OS-8289 OS-8228 OS-8240 OS-8252	E2, E3, E4, O, CO, CR, LN, TO, TR x All Studio Collection levers (Except Gramercy, Grant Park, Wooster Square Series)		\$353.00	\$371.00
OS-8215 OS-8294 OS-8296 OS-8297			\$341.00	\$361.00
OS-8265 OS-8266 OS-8268			\$373.00	\$395.00

Experience a safer
and more open world

Copyright © 2002-2021 Sargent Manufacturing Company, an ASSA ABLOY Group company. All rights reserved.
Reproduction in whole or in part without the express written permission of Sargent Manufacturing Company is prohibited.
Contact us at: 800-727-5477 or visit www.sargentlock.com. In Canada contact us at: 800-461-3007 or visit www.assaabloydss.ca

8200 OUTSIDE TRIM SET

USA & Canada Prices Effective May 1, 2021

Lock Function Gramercy Series Trim	Rose	Lever	10BE/BSP/WSP/629/630	
OS-8204 OS-8229 OS-8241 OS-8255 OS-8205 OS-8230 OS-8243 OS-8256 OS-8216 OS-8231 OS-8245 OS-8267 OS-8217 OS-8235 OS-8246 OS-8270 OS-8224 OS-8236 OS-8247 OS-8271 OS-8225 OS-8237 OS-8248 OS-8272 OS-8226 OS-8238 OS-8250 OS-8273 OS-8227 OS-8239 OS-8251 OS-8289 OS-8228 OS-8240 OS-8252	E2, E3, E4, O, CO, CR, LN, TO, TR	x Gramercy Series (RAM-RAS-REM-RGM)	\$387.00	
OS-8215 OS-8294 OS-8296 OS-8297			\$378.00	
OS-8265 OS-8266 OS-8268			\$405.00	
Lock Function Studio Collection Trim	Rose	Lever	629/630	
OS-8204 OS-8229 OS-8241 OS-8255 OS-8205 OS-8230 OS-8243 OS-8256 OS-8216 OS-8231 OS-8245 OS-8267 OS-8217 OS-8235 OS-8246 OS-8270 OS-8224 OS-8236 OS-8247 OS-8271 OS-8225 OS-8237 OS-8248 OS-8272 OS-8226 OS-8238 OS-8250 OS-8273 OS-8227 OS-8239 OS-8251 OS-8289 OS-8228 OS-8240 OS-8252	E2, E3, E4, O, CO, CR, LN, TO, TR	x Gramercy Series (RAL-RCM)	\$416.00	
OS-8215 OS-8294 OS-8296 OS-8297			\$408.00	
OS-8265 OS-8266 OS-8268			\$425.00	
Lock Function Studio Collection Trim	Roseless x Lever	10E/E/26D/BSP/WSP	03/04/09/10/10B/10BL/14/15/20D/26	
OS-R8204 OS-R8227 OS-R8238 OS-R8271 OS-R8205 OS-R8228 OS-R8239 OS-R8272 OS-R8216 OS-R8230 OS-R8240 OS-R8273 OS-R8217 OS-R8231 OS-R8252 OS-R8289 OS-R8224 OS-R8235 OS-R8256 OS-R8225 OS-R8236 OS-R8267 OS-R8226 OS-R8237 OS-R8270	R x G, R, S, Y		\$388.00	\$402.00
OS-R8215 OS-R8296 OS-R8294 OS-R8297			\$371.00	\$393.00
OS-R8265 OS-R8266 OS-R8268			\$406.00	\$428.00
Lock Function Studio Collection Trim	Roseless x Lever	10E/E/26D/BSP/WSP	03/04/09/10/10B/10BL/14/15/20D/26/32/32D	
OS-R8204 OS-R8227 OS-R8238 OS-R8271 OS-R8205 OS-R8228 OS-R8239 OS-R8272 OS-R8216 OS-R8230 OS-R8240 OS-R8273 OS-R8217 OS-R8231 OS-R8252 OS-R8289 OS-R8224 OS-R8235 OS-R8256 OS-R8225 OS-R8236 OS-R8267 OS-R8226 OS-R8237 OS-R8270	R x All Studio Collection Levers (Except Gramercy, Grant Park, Wooster Square Series)		\$388.00	\$402.00
OS-R8215 OS-R8296 OS-R8294 OS-R8297			\$371.00	\$393.00
OS-R8265 OS-R8268 OS-R8266			\$406.00	\$428.00

ML-104 MORTISE LOCKS

SARGENT®

8200 OUTSIDE TRIM SET

ASSA ABLOY

USA & Canada Prices Effective May 1, 2021

Lock Function Coastal Trim	*Esc. x Lever	10BE/26D/BSP/WSP	03/04/09/10/10B/10BL/14/15/20D/26
OS-8204 OS-8229 OS-8241 OS-8255 OS-8205 OS-8230 OS-8243 OS-8256 OS-8216 OS-8231 OS-8245 OS-8267 OS-8217 OS-8235 OS-8246 OS-8270 OS-8224 OS-8236 OS-8247 OS-8271 OS-8225 OS-8237 OS-8248 OS-8272 OS-8226 OS-8238 OS-8250 OS-8273 OS-8227 OS-8239 OS-8251 OS-8289 OS-8228 OS-8240 OS-8252	*TE, CE	G*, R, S*, Y*	\$484.00 \$502.00
OS-8215 OS-8294 OS-8296 OS-8297	*TE, CE	G*, R, S*, Y*	\$474.00 \$488.00
OS-8265 OS-8266 OS-8268	*TE, CE	G*, R, S*, Y*	\$503.00 \$517.00
Lock Function Gramercy Series Trim	Esc. x Lever	10BE/26D/BSP/WSP	03/04/09/10/10B/10BL/14/15/20D/26/32/32D
OS-8204 OS-8229 OS-8241 OS-8255 OS-8205 OS-8230 OS-8243 OS-8256 OS-8216 OS-8231 OS-8245 OS-8267 OS-8217 OS-8235 OS-8246 OS-8270 OS-8224 OS-8236 OS-8247 OS-8271 OS-8225 OS-8237 OS-8248 OS-8272 OS-8226 OS-8238 OS-8250 OS-8273 OS-8227 OS-8239 OS-8251 OS-8289 OS-8228 OS-8240 OS-8252	TE, CE, LE1 x All Studio Collection levers (Except Gramercy Series)		\$484.00 \$502.00
OS-8215 OS-8294 OS-8296 OS-8297			\$474.00 \$488.00
OS-8265 OS-8266 OS-8268			\$503.00 \$517.00
Lock Function Gramercy Series Trim	Esc. x Lever	10BE/BSP/WSP/629/630	
OS-8204 OS-8229 OS-8241 OS-8255 OS-8205 OS-8230 OS-8243 OS-8256 OS-8216 OS-8231 OS-8245 OS-8267 OS-8217 OS-8235 OS-8246 OS-8270 OS-8224 OS-8236 OS-8247 OS-8271 OS-8225 OS-8237 OS-8248 OS-8272 OS-8226 OS-8238 OS-8250 OS-8273 OS-8227 OS-8239 OS-8251 OS-8289 OS-8228 OS-8240 OS-8252	TE, CE, LE1 x Gramercy Series (RAM-RAS-REM-RGM)		\$421.00
OS-8215 OS-8294 OS-8296 OS-8297			\$414.00
OS-8265 OS-8266 OS-8268			\$440.00
Lock Function Gramercy Series Trim	Esc. x Lever	10BE/BSP/WSP/629/630	
OS-8204 OS-8229 OS-8241 OS-8255 OS-8205 OS-8230 OS-8243 OS-8256 OS-8216 OS-8231 OS-8245 OS-8267 OS-8217 OS-8235 OS-8246 OS-8270 OS-8224 OS-8236 OS-8247 OS-8271 OS-8225 OS-8237 OS-8248 OS-8272 OS-8226 OS-8238 OS-8250 OS-8273 OS-8227 OS-8239 OS-8251 OS-8289 OS-8228 OS-8240 OS-8252	TE, CE, LE1 x Gramercy Series (RAG-RAL-RCM)		\$447.00
OS-8215 OS-8294 OS-8296 OS-8297			\$396.00
OS-8265 OS-8266 OS-8268			\$430.00

Experience a safer
and more open world

Copyright © 2002-2021 Sargent Manufacturing Company, an ASSA ABLOY Group company. All rights reserved.
Reproduction in whole or in part without the express written permission of Sargent Manufacturing Company is prohibited.
Contact us at: 800-727-5477 or visit www.sargentlock.com. In Canada contact us at: 800-461-3007 or visit www.assaabloydss.ca

USA & Canada Prices Effective May 1, 2021

Example: OS-8225 LW1P x US3 x RH

Outside trim sets include: Outside lever, outside rose or escutcheon, outside mounting plate, two thru-bolt studs, washers, retaining nut, and cylinder rosettes (for cylinder functions only). CYLINDERS NOT INCLUDED – Order separately.

*Note: "A" lever design and all escutcheon designs are handed. Please specify hand when ordering.

Lock Function	*Esc.	Lever	10BE/26D/BSP/WSP	03/04/09/10/10B/10BL/14/15/20D/26/32/32D
OS-8204 OS-8229 OS-8241 OS-8255 OS-8205 OS-8230 OS-8243 OS-8256 OS-8216 OS-8231 OS-8245 OS-8267 OS-8217 OS-8235 OS-8246 OS-8270 OS-8224 OS-8236 OS-8247 OS-8271 OS-8225 OS-8237 OS-8248 OS-8272 OS-8226 OS-8238 OS-8250 OS-8273 OS-8227 OS-8239 OS-8251 OS-8289 OS-8228 OS-8240 OS-8252	*LW1	*A, B, E, F, J, L, P, W	\$461.00	\$475.00
OS-8215 OS-8294 OS-8296 OS-8297	*LW1	*A, B, E, F, J, L, P, W	\$443.00	\$452.00
OS-8265 OS-8266 OS-8268	*LW1	*A, B, E, F, J, L, P, W	\$478.00	\$487.00

Lock Function	*Esc.	Lever	10BE/26D/BSP/WSP	03/04/09/10/10B/10BL/14/15/20D/26/32/32D
OS-8204 OS-8229 OS-8241 OS-8255 OS-8205 OS-8230 OS-8243 OS-8256 OS-8216 OS-8231 OS-8245 OS-8267 OS-8217 OS-8235 OS-8246 OS-8270 OS-8224 OS-8236 OS-8247 OS-8271 OS-8225 OS-8237 OS-8248 OS-8272 OS-8226 OS-8238 OS-8250 OS-8273 OS-8227 OS-8239 OS-8251 OS-8289 OS-8228 OS-8240 OS-8252	*LE1	*A, B, E, F, J, L, P, W,	\$479.00	\$491.00
OS-8215 OS-8294 OS-8296 OS-8297	*LE1		\$465.00	\$483.00
OS-8265 OS-8266 OS-8268	*LE1		\$493.00	\$513.00

Lock Function	*Esc.	Lever	Add to LE1 prices above:	
Standard Cylinder x concealed mounting	*LE2	*A, B, E, F, J, L, P, W	\$16.00	Each
Non-Keyed Function x concealed mounting	*LE2		\$16.00	Each
Cylinder Barrel x exposed screws	*LE3	*A, B, E, F, J, L, P, W	\$46.00	Each
Non-Keyed Function x exposed screws	*LE3		\$16.00	Each
Cylinder Barrel only x concealed mounting	*LE4	*A, B, E, F, J, L, P, W	\$51.00	Each
Non-Keyed Function x concealed mounting	*LE4		\$16.00	Each

Note: LE3, LE4 not available w/double cylinder functions

Lock Function	*Esc.	Lever	10BE/26D/BSP/WSP	03/04/09/10/10B/10BL/14/15/20D/26/32/32D
OS-8204 OS-8229 OS-8241 OS-8255 OS-8205 OS-8230 OS-8243 OS-8256 OS-8216 OS-8231 OS-8245 OS-8267 OS-8217 OS-8235 OS-8246 OS-8270 OS-8224 OS-8236 OS-8247 OS-8271 OS-8225 OS-8237 OS-8248 OS-8272 OS-8226 OS-8238 OS-8250 OS-8273 OS-8227 OS-8239 OS-8251 OS-8289 OS-8228 OS-8240 OS-8252	*WT	*A, B, E, F, J, L, P, W	\$449.00	\$463.00
OS-8215 OS-8294 OS-8296 OS-8297	*WT	*A, B, E, F, J, L, P, W	\$435.00	\$456.00
OS-8265 OS-8266 OS-8268	*WT	*A, B, E, F, J, L, P, W	\$465.00	\$483.00

Lock Function	*Esc.	Lever	10BE/26D/BSP/WSP	03/04/09/10/10B/10BL/14/15/20D/26/32/32D
OS-8204 OS-8229 OS-8241 OS-8255 OS-8205 OS-8230 OS-8243 OS-8256 OS-8216 OS-8231 OS-8245 OS-8267 OS-8217 OS-8235 OS-8246 OS-8270 OS-8224 OS-8236 OS-8247 OS-8271 OS-8225 OS-8237 OS-8248 OS-8272 OS-8226 OS-8238 OS-8250 OS-8273 OS-8227 OS-8239 OS-8251 OS-8289 OS-8228 OS-8240 OS-8252	*LS	*A, B, E, F, J, L, P, W	\$730.00	\$740.00
OS-8215 OS-8294 OS-8296 OS-8297	*LS	*A, B, E, F, J, L, P, W	\$718.00	\$733.00
OS-8265 OS-8266 OS-8268	*LS	*A, B, E, F, J, L, P, W	\$752.00	\$762.00

Lock Function	*Esc.	Lever	10BE/26D/BSP/WSP	03/04/09/10/10B/10BL/14/15/20D/26/32/32D
OS-8204 OS-8224 OS-8235 OS-8239 OS-8205 OS-8225 OS-8236 OS-8240 OS-8216 OS-8226 OS-8226 OS-8237 OS-8217 OS-8231 OS-8238	*FE	*A, B, E, F, J, L, P, W	\$526.00	\$544.00
OS-8265 OS-8266	*FE	*A, B, E, F, J, L, P, W	\$547.00	\$556.00

ML-106 MORTISE LOCKS

SARGENT®

7800 INSIDE TRIM SET

ASSA ABLOY

USA & Canada Prices Effective May 1, 2021

Example: IS-7825 KE1B x US3 x RH

Inside trim sets include: Inside knob, inside rose or escutcheon, trim pack (spindles, thrubolt screws, set screws, inside adaptor plate assembly), trim finish screws (for escutcheons). CYLINDERS NOT INCLUDED – Order separately.

*Note: All escutcheon designs are handed. **Please specify hand when ordering.**

Lock Function	Rose	Knob	10BE/26D/BSP/WSP	03/04/09/10/10B/10BL/14/15/20D/26/32/32D
IS-7804 IS-7815 IS-7867				
IS-7805 IS-7837 IS-7895	E, L, O	B, C	\$316.00	\$327.00
IS-7806 IS-7855 IS-7896				
IS-7813 IS-7856 IS-7897				
IS-7816 IS-7838 IS-7846				
IS-7817 IS-7839 IS-7848	E, L, O	B, C	\$322.00	\$341.00
IS-7826 IS-7840 IS-7852				
IS-7829 IS-7841 IS-7892				

IS-7824 IS-7830 IS-7850 IS-7868				
IS-7825 IS-7843 IS-7851	E, L, O	B, C	\$355.00	\$369.00
IS-7827 IS-7845 IS-7865				
IS-7828 IS-7847 IS-7866				

Lock Function	*Esc.	Knob	10BE/26D/BSP/WSP	03/04/09/10/10B/10BL/14/15/20D/26/32/32D
IS-7804 IS-7815 IS-7867				
IS-7805 IS-7837 IS-7895	*KE1	B, C	\$498.00	\$519.00
IS-7806 IS-7855 IS-7896				
IS-7813 IS-7856 IS-7897				
IS-7816 IS-7838 IS-7846				
IS-7817 IS-7839 IS-7848	*KE1	B, C	\$512.00	\$531.00
IS-7826 IS-7840 IS-7852				
IS-7829 IS-7841 IS-7892				

IS-7824 IS-7830 IS-7850 IS-7868				
IS-7825 IS-7843 IS-7851	*KE1	B, C	\$542.00	\$556.00
IS-7827 IS-7845 IS-7865				
IS-7828 IS-7847 IS-7866				

Lock Function	*Esc.	Knob	Add to KE1 prices above:
Standard Cylinder x concealed mounting	*KE2	B, C	\$16.00 Each
Non-Keyed Function x concealed mounting	*KE2		\$16.00 Each
Cylinder Barrel x exposed screws	*KE3	B, C	\$46.00 Each
Non-Keyed Function x exposed screws	*KE3		\$16.00 Each
Cylinder Barrel only x concealed mounting	*KE4	B, C	\$51.00 Each
Non-Keyed Function x concealed mounting	*KE4		\$16.00 Each

Note: KE3, KE4 not available w/double cylinder functions

Lock Function	*Esc.	Knob	10BE/26D/BSP/WSP	03/04/09/10/10B/10BL/14/15/20D/26/32/32D
IS-7804 IS-7815 IS-7867				
IS-7805 IS-7837 IS-7895	*KW1	B, C	\$459.00	\$477.00
IS-7806 IS-7855 IS-7896				
IS-7813 IS-7856 IS-7897				
IS-7816 IS-7838 IS-7846				
IS-7817 IS-7839 IS-7848	*KW1	B, C	\$470.00	\$488.00
IS-7826 IS-7840 IS-7852				
IS-7829 IS-7841 IS-7892				
IS-7824 IS-7830 IS-7850 IS-7868				
IS-7825 IS-7843 IS-7851	*KW1	B, C	\$497.00	\$515.00
IS-7827 IS-7845 IS-7865				
IS-7828 IS-7847 IS-7866				

Experience a safer
and more open world

Copyright © 2002-2021 Sargent Manufacturing Company, an ASSA ABLOY Group company. All rights reserved.
Reproduction in whole or in part without the express written permission of Sargent Manufacturing Company is prohibited.
Contact us at: 800-727-5477 or visit www.sargentlock.com. In Canada contact us at: 800-461-3007 or visit www.assaabloydss.ca

USA & Canada Prices Effective May 1, 2021

Example: IS-7825 WTB x US3 x RH

Inside trim sets include: Inside knob, inside rose or escutcheon, trim pack (spindles, thru-bolt screws, set screws, inside adaptor plate assembly), trim finish screws (for escutcheons). CYLINDERS NOT INCLUDED – Order separately.

*Note: All escutcheon designs are handed. **Please specify hand when ordering.**

Lock Function	*Esc.	Knob	10BE/26D/BSP/WSP	03/04/09/10/10B/10BL/14/15/20D/26/32/32D
IS-7804 IS-7815 IS-7867				
IS-7805 IS-7837 IS-7895	*WT	B, C	\$433.00	\$450.00
IS-7806 IS-7855 IS-7896				
IS-7813 IS-7856 IS-7897				
IS-7816 IS-7838 IS-7846				
IS-7817 IS-7839 IS-7848	*WT	B, C	\$446.00	\$459.00
IS-7826 IS-7840 IS-7852				
IS-7829 IS-7841 IS-7892				
IS-7824 IS-7830 IS-7850 IS-7868				
IS-7825 IS-7843 IS-7851	*WT	B, C	\$475.00	\$489.00
IS-7827 IS-7845 IS-7865				
IS-7828 IS-7847 IS-7866				
Lock Function	*Esc.	Knob	10BE/26D/BSP/WSP	03/04/09/10/10B/10BL/14/15/20D/26/32/32D
IS-7804 IS-7815 IS-7867				
IS-7805 IS-7837 IS-7895	*WT	N	\$466.00	\$488.00
IS-7806 IS-7855 IS-7896				
IS-7813 IS-7856 IS-7897				
IS-7816 IS-7838 IS-7846				
IS-7817 IS-7839 IS-7848	*WT	N	\$477.00	\$496.00
IS-7826 IS-7840 IS-7852				
IS-7829 IS-7841 IS-7892				
IS-7824 IS-7830 IS-7850 IS-7868				
IS-7825 IS-7843 IS-7851	*WT	N	\$503.00	\$521.00
IS-7827 IS-7845 IS-7865				
IS-7828 IS-7847 IS-7866				
Lock Function	*Esc.	Knob	10BE/26D/BSP/WSP	03/04/09/10/10B/14/15/26/32/32D
IS-7804 IS-7806 IS-7815	*KS	K	\$735.00	\$748.00
IS-7805 IS-7813 IS-7837				
IS-7816 IS-7826 IS-7839 IS-7841	*KS	K	\$744.00	\$761.00
IS-7817 IS-7838 IS-7840				
IS-7824 IS-7843 IS-7850 IS-7866	*KS	K	\$772.00	\$790.00
IS-7825 IS-7845 IS-7865				
Lock Function	Rose	Knob	32D	32
IS-7804 IS-7815 IS-7867				
IS-7805 IS-7837 IS-7895	*SL	D	\$804.00	\$807.00
IS-7806 IS-7855 IS-7896				
IS-7813 IS-7856 IS-7897				
IS-7816 IS-7838 IS-7846				
IS-7817 IS-7839 IS-7848	*SL	D	\$810.00	\$814.00
IS-7826 IS-7840 IS-7852				
IS-7829 IS-7841 IS-7892				
IS-7824 IS-7830 IS-7850 IS-7868				
IS-7825 IS-7843 IS-7851	*SL	D	\$839.00	\$841.00
IS-7827 IS-7845 IS-7865				
IS-7828 IS-7847 IS-7866				

ML-108 MORTISE LOCKS

SARGENT®

7800 OUTSIDE TRIM SET

ASSA ABLOY

USA & Canada Prices Effective May 1, 2021

Example: OS-7825 KW1B x US3 x RH

Outside trim sets include: Outside knob, outside rose or escutcheon, outside mounting plate, two thru-bolt studs, washers, retaining nut, and cylinder rosettes (for cylinder functions only). CYLINDERS NOT INCLUDED – Order separately.

*Note: All escutcheon designs are handed. **Please specify hand when ordering.**

Lock Function	Rose	Knob	10BE/26D/BSP/WSP	03/04/09/10/10B/10BL/14/15/20D/26/32/32D
OS-7804 OS-7829 OS-7841 OS-7855				
OS-7805 OS-7830 OS-7843 OS-7856				
OS-7816 OS-7831 OS-7845 OS-7867				
OS-7817 OS-7835 OS-7846				
OS-7824 OS-7836 OS-7847	E, L, O	B, C	\$333.00	\$352.00
OS-7825 OS-7837 OS-7848				
OS-7826 OS-7838 OS-7850				
OS-7827 OS-7839 OS-7851				
OS-7828 OS-7840 OS-7852				
OS-7815 OS-7894 OS-7896 OS-7897	E, L, O	B, C	\$322.00	\$341.00
OS-7865 OS-7866 OS-7868	E, L, O	B, C	\$355.00	\$369.00
Lock Function	*Esc.	Knob	10BE/26D/BSP/WSP	03/04/09/10/10B/10BL/14/15/20D/26/32/32D
OS-7804 OS-7829 OS-7841 OS-7855				
OS-7805 OS-7830 OS-7843 OS-7856				
OS-7816 OS-7831 OS-7845 OS-7867				
OS-7817 OS-7835 OS-7846				
OS-7824 OS-7836 OS-7847	*KE1	B, C	\$531.00	\$548.00
OS-7825 OS-7837 OS-7848				
OS-7826 OS-7838 OS-7850				
OS-7827 OS-7839 OS-7851				
OS-7828 OS-7840 OS-7852				
OS-7815 OS-7894 OS-7896 OS-7897	*KE1	B, C	\$519.00	\$538.00
OS-7865 OS-7866 OS-7868	*KE1	B, C	\$549.00	\$564.00
Lock Function	*Esc.	Knob	Add to KE1 prices above:	
Standard Cylinder x concealed mounting	*KE2	B, C	\$7.00	Each
Non-Keyed Function x concealed mounting	*KE2		\$7.00	Each
Cylinder Barrel x exposed screws	*KE3	B, C	\$47.00	Each
Non-Keyed Function x exposed screws	*KE3		\$7.00	Each
Cylinder Barrel only x concealed mounting	*KE4	B, C	\$55.00	Each
Non-Keyed Function x concealed mounting	*KE4		\$7.00	Each
Note: KE3, KE4 not available w/double cylinder functions				
Lock Function	*Esc.	Knob	10BE/26D/BSP/WSP	03/04/09/10/10B/10BL/14/15/20D/26/32/32D
OS-7804 OS-7829 OS-7841 OS-7855				
OS-7805 OS-7830 OS-7843 OS-7856				
OS-7816 OS-7831 OS-7845 OS-7867				
OS-7817 OS-7835 OS-7846				
OS-7824 OS-7836 OS-7847	*KW1	B, C	\$483.00	\$497.00
OS-7825 OS-7837 OS-7848				
OS-7826 OS-7838 OS-7850				
OS-7827 OS-7839 OS-7851				
OS-7828 OS-7840 OS-7852				
OS-7815 OS-7894 OS-7896 OS-7897	*KW1	B, C	\$475.00	\$489.00
OS-7865 OS-7866 OS-7868	*KW1	B, C	\$498.00	\$519.00

Experience a safer
and more open world

Copyright © 2002-2021 Sargent Manufacturing Company, an ASSA ABLOY Group company. All rights reserved.
Reproduction in whole or in part without the express written permission of Sargent Manufacturing Company is prohibited.
Contact us at: 800-727-5477 or visit www.sargentlock.com. In Canada contact us at: 800-461-3007 or visit www.assaabloydss.ca

7800 OUTSIDE TRIM SET

USA & Canada Prices Effective May 1, 2021

Example: OS-7825 KW1B x US3 x RH

Outside trim sets include: Outside knob, outside rose or escutcheon, outside mounting plate, two thrubolt studs, washers, retaining nut, and cylinder rosettes (for cylinder functions only). CYLINDERS NOT INCLUDED – Order separately.

*Note: All escutcheon designs are handed. **Please specify hand when ordering.**

Lock Function	*Esc.	Knob	10BE/26D/BSP/WSP	03/04/09/10/10B/10BL/14/15/20D/26/32/32D
OS-7804 OS-7829 OS-7841 OS-7855				
OS-7805 OS-7830 OS-7843 OS-7856				
OS-7816 OS-7831 OS-7845 OS-7867				
OS-7817 OS-7835 OS-7846				
OS-7824 OS-7836 OS-7847	*WT	B, C	\$455.00	\$475.00
OS-7825 OS-7837 OS-7848				
OS-7826 OS-7838 OS-7850				
OS-7827 OS-7839 OS-7851				
OS-7828 OS-7840 OS-7852				
OS-7815 OS-7894 OS-7896 OS-7897	*WT	B, C	\$447.00	\$460.00
OS-7865 OS-7866 OS-7868	*WT	B, C	\$476.00	\$490.00
Lock Function	*Esc.	Knob	10BE/26D/BSP/WSP	03/04/09/10/10B/10BL/14/15/20D/26/32/32D
OS-7804 OS-7829 OS-7841 OS-7855				
OS-7805 OS-7830 OS-7843 OS-7856				
OS-7816 OS-7831 OS-7845 OS-7867				
OS-7817 OS-7835 OS-7846				
OS-7824 OS-7836 OS-7847	*WT	N	\$490.00	\$509.00
OS-7825 OS-7837 OS-7848				
OS-7826 OS-7838 OS-7850				
OS-7827 OS-7839 OS-7851				
OS-7828 OS-7840 OS-7852				
OS-7815 OS-7894 OS-7896 OS-7897	*WT	N	\$483.00	\$498.00
OS-7865 OS-7866 OS-7868	*WT	N	\$509.00	\$526.00
Lock Function	*Esc.	Knob	10BE/26D/BSP/WSP	03/04/09/10/10B/10BL/14/15/26/32/32D
OS-7804 OS-7825 OS-7837 OS-7843				
OS-7805 OS-7826 OS-7838 OS-7845				
OS-7816 OS-7831 OS-7839 OS-7850	*KS	K	\$768.00	\$788.00
OS-7817 OS-7835 OS-7840				
OS-7824 OS-7836 OS-7841				
OS-7815	*KS	K	\$761.00	\$777.00
OS-7865 OS-7866	*KS	K	\$790.00	\$806.00
Lock Function	Rose	Knob	32D	32
OS-7804 OS-7829 OS-7841 OS-7855				
OS-7805 OS-7830 OS-7843 OS-7856				
OS-7816 OS-7831 OS-7845 OS-7867				
OS-7817 OS-7835 OS-7846				
OS-7824 OS-7836 OS-7847	SL	D	\$868.00	\$870.00
OS-7825 OS-7837 OS-7848				
OS-7826 OS-7838 OS-7850				
OS-7827 OS-7839 OS-7851				
OS-7828 OS-7840 OS-7852				
OS-7815 OS-7894 OS-7896 OS-7897	SL	D	\$840.00	\$844.00
OS-7865 OS-7866 OS-7868	SL	D	\$869.00	\$872.00

ML-110 MORTISE LOCKS

SARGENT®

8200 LEVERS

ASSA ABLOY

USA & Canada Prices Effective May 1, 2021

Outside Levers			
Part #	Design	10BE/26D/BSP/WSP	03/04/09/10/10B/10BL/ 14/15/20D/26/32/32D
82-0151	A - RH/RHR	\$173.95	\$193.94
82-0152	A - LH/LHR	\$173.95	\$193.94
82-0153	B	\$160.64	\$181.23
82-0154	E	\$173.95	\$193.94
82-0155	F	\$173.95	\$193.94
82-0156	J	\$131.82	\$152.41
97-0486 (for FE Esc)	J	\$141.71	\$163.86
82-0157	L	\$160.64	\$181.23
97-0485 (for FE Esc)	L	\$172.71	\$194.84
82-0158	P	\$160.64	\$181.23
97-0484 (for FE Esc)	P	\$172.71	\$194.84
82-0159	W	\$173.95	\$193.94

Outside Coastal Series Levers			
Part #	Design	10BE/26D/BSP/WSP	03/04/09/10/10B/10BL/ 14/15/20D/26
82-0517	R		
82-0522	S - LH/LHR		
82-0523	S - RH/RHR	\$173.95	\$193.94
82-0526	G - LH/LHR		
82-0527	G - RH/RHR		
82-0530	Y - LH/LHR		
82-0531	Y - RH/RHR		

Outside Studio Collection Levers			
Part #	Design	10BE/26D/BSP/WSP	03/04/09/10/10B/10BL/ 14/15/20D/26/32/32D
82-0803	MA		
82-0806	MB		
82-0809	MC		
82-0812	MD		
82-0815	ME		
82-0818	MF		
82-0821	MG		
82-0824	MH - RH		
82-0827	MH - LH		
82-0830	MI		
82-0833	MJ		
82-0836	MK - RH		
82-0839	MK - LH		
82-0848	MM - RH		
82-0851	MM - LH		
82-0854	MN - RH		
82-0857	MN - LH		
82-0860	MO		
82-0863	MP		
82-0866	MQ - RH		
82-0869	MQ - LH		
82-1243	MS - RH	\$173.95	\$193.94
82-1244	MS - LH		
82-0881	MT - RH		
82-0884	MT - LH		
82-1251	MU - RH		
82-1252	MU - LH		
82-0893	MV - RH		
82-0896	MV - LH		
82-0899	MW		
82-1087	MX - RH		
82-1090	MX - LH		
82-1075	MY - RH		
82-1078	MY - LH		
82-1081	MZ - RH		
82-1084	MZ - LH		
82-0909	ND		
82-1277	NF		
82-0915	NJ		
82-0903	NS - RH		
82-0906	NS - LH		
82-1066	NU - RH		
82-1069	NU - LH		
82-1952	H015		
82-1956	H016		
82-1948	H017		
81-0862	H018		

8200 Outside Gramercy Series Levers			
Part#	Available Finishes	Design	Price
RW-2002	2929 or 3030	REM	\$191.27
RW-2006	2930, 3030, or 2930	RCM	\$242.98
RW-2018	29BK or 30BK	RAS	\$191.27
RW-2022	29BK, 29BN or 30BK, 30BN	RAL	\$261.08
RW-2026	2929 or 3030	RGM	\$191.27
RW-2030	2929 or 3030	RAG	\$242.98

8200 Outside Wooster Square and Grant Park Levers			
Part#	Design	10BE/26D/BSP/WSP	03/04/09/10/10B/10BL/ 14/15/20D/26/32/32D
82-1582	H001		
82-1585	H002		
82-5266	H003		
82-5269	H004		
82-5272	H005		
82-5275	H006	\$216.56	\$236.14
82-1594	H007		
82-1599	H008		
82-1603	H009		
82-1606	H010		
82-1609	H011		

Experience a safer
and more open world

Copyright © 2002-2021 Sargent Manufacturing Company, an ASSA ABLOY Group company. All rights reserved.
Reproduction in whole or in part without the express written permission of Sargent Manufacturing Company is prohibited.
Contact us at: 800-727-5477 or visit www.sargentlock.com. In Canada contact us at: 800-461-3007 or visit www.assaabloydss.ca

Inside Levers		10BE/26D/BSP/WSP	03/04/09/10/10B/10BL 14/15/20D/26/32/32D
Part #	Design		
81-0467	A - LH/LHR	\$173.95	\$193.94
81-0468	A - RH/RHR	\$173.95	\$193.94
81-0490	B	\$160.64	\$181.23
81-0470	E	\$173.95	\$193.94
81-0471	F	\$173.95	\$193.94
81-0447	J	\$131.82	\$152.41
81-0489	L	\$160.64	\$181.23
81-0513	P	\$160.64	\$181.23
81-0445	W	\$173.95	\$193.94

Inside Coastal Series Levers		10BE/26D/BSP/WSP	03/04/09/10/10B/10BL 14/15/20D/26
Part #	Design		
82-0516	R		
82-0520	S - LH/LHR		
82-0521	S - RH/RHR		
82-0524	G - LH/LHR	\$173.95	\$193.94
82-0525	G - RH/RHR		
82-0528	Y - LH/LHR		
82-0529	Y - RH/RHR		

8200 Inside Studio Collection Levers		10BE/26D/BSP/WSP	03/04/09/10/10B/10BL/ 14/15/20D/26/32/32D
Part #	Design		
82-0802	MA		
82-0805	MB		
82-0808	MC		
82-0811	MD		
82-0814	ME		
82-0817	MF		
82-0820	MG		
82-0823	MH - LH		
82-0826	MH - RH		
82-0829	MI		
82-0832	MJ		
82-0835	MK - LH		
82-0838	MK - RH		
82-0847	MM - LH		
82-0850	MM - RH		
82-0853	MN - LH		
82-0856	MN - RH		
82-0859	MO		
82-0862	MP		
82-0865	MQ - LH		
82-0868	MQ - RH		
82-1241	MS - LH	\$173.95	\$193.94
82-1242	MS - RH		
82-0880	MT - LH		
82-0883	MT - RH		
82-1250	MU - LH		
82-1249	MU - RH		
82-0892	MV - LH		
82-0895	MV - RH		
82-0898	MW		
82-1086	MX - RH		
82-1089	MX - LH		
82-1074	MY - RH		
82-1077	MY - LH		
82-1080	MZ - RH		
82-1083	MZ - LH		
82-0908	ND		
82-1276	NF		
82-0914	NJ		
82-0902	NS - RH		
82-0905	NS - LH		
82-1065	NU - RH		
82-1068	NU - LH		
82-1951	H015		
82-1955	H016		
82-1947	H017		
81-0861	H018		

Note: Inside lever handle is used for outside trim with 31, 35, 36 (trim-one-side) functions.

Note: Levers provided with lever spring & set screw. Handed levers should be ordered to the hand of the door – example: a RH door/lock will need a RH O/S lever and a RH I/S lever.

8200 Inside Gramercy Series Levers			
Part#	Available Finishes	Design	Price
RW-2001	2929 or 3030	REM	\$191.27
RW-2005	2930, 3030, or 2930	RCM	\$242.98
RW-2009	2930	RAM	\$191.27
RW-2017	29BK or 30BK	RAS	\$191.27
RW-2021	29BK, 29BN or 30BK, 30BN	RAL	\$261.08
RW-2025	2929 or 3030	RGM	\$191.27
RW-2029	2929 or 3030	RAG	\$242.98

8200 Inside Wooster Square and Grant Park Levers		10BE/26D/BSP/WSP	03/04/09/10/10B/10BL/ 14/15/20D/26/32/32D
Part#	Design		
82-1581	H001		
82-1584	H002		
82-5265	H003		
82-5268	H004		
82-5271	H005		
82-5274	H006	\$216.56	\$236.14
82-1593	H007		
82-1597	H008		
82-1602	H009		
82-1605	H010		
82-1608	H011		

ML-112 MORTISE LOCKS

SARGENT®

8200 MILLED LEVERS & 7800 KNOBS

ASSA ABLOY

USA & Canada Prices Effective May 1, 2021

Milled Outside Levers			03/04/09/10/10B/10BL/ 14/15/20D/26/32/32D
Part #	Design	10BE/26D/BSP/WSP	
82-0306	A - LH/LHR	\$280.28	\$300.88
82-0307	A - RH/RHR	\$280.28	\$300.88
82-0308	B	\$261.73	\$282.33
82-0311	E	\$280.28	\$300.88
82-0312	F	\$280.28	\$300.88
82-0309	J	\$232.91	\$253.46
82-0313	L	\$261.73	\$282.33
82-0314	P	\$261.73	\$282.33
82-0310	W	\$280.28	\$300.88

Milled Inside Levers			03/04/09/10/10B/10BL/ 14/15/20D/26/32/32D
Part #	Design	10BE/26D/BSP/WSP	
82-0315	A - LH/LHR	\$280.28	\$300.88
82-0316	A - RH/RHR	\$280.28	\$300.88
82-0317	B	\$261.73	\$282.33
82-0320	E	\$280.28	\$300.88
82-0321	F	\$280.28	\$300.88
82-0318	J	\$232.91	\$253.46
82-0322	L	\$261.73	\$282.33
82-0323	P	\$261.73	\$282.33
82-0319	W	\$280.28	\$300.88

Outside Knobs			03/04/09/10/10B/10BL/ 14/15/20D/26/32/32D
Part #	Design	10BE/26D/BSP/WSP	
78-2875	B	\$147.47	\$149.50
78-2876	C	\$147.47	\$149.50
78-2742	K	\$260.66	-
78-2759	N	\$147.47	\$149.50
92-0084	D	\$432.85 (32D)	\$450.15 (32)

Inside Knobs			03/04/09/10/10B/10BL/ 14/15/20D/26/32/32D
Part #	Design	10BE/26D/BSP/WSP	
78-2877	B	\$147.47	\$149.50
78-0508	C	\$147.47	\$149.50
78-2743	K	\$260.66	-
78-2755	N	\$147.47	\$149.50
92-0086	D	\$432.85 (32D)	\$450.15 (32)

Note: B & C Knob not available on KS Escutcheon.
 (1485) K Knob only available on KS Escutcheon.
 (1673) N Knob only available on WT Escutcheon.

Note: Inside lever/knob handle is used for outside trim with 31, 35, 36 (trim-one-side) functions.

Note: Levers provided with lever spring & set screw.
 Handed levers should be ordered to the hand of the door - example: a RH door/lock will need a RH O/S lever and a RH I/S lever

Experience a safer
and more open world

Copyright © 2002-2021 Sargent Manufacturing Company, an ASSA ABLOY Group company. All rights reserved.
 Reproduction in whole or in part without the express written permission of Sargent Manufacturing Company is prohibited.
 Contact us at: 800-727-5477 or visit www.sargentlock.com. In Canada contact us at: 800-461-3007 or visit www.assaabloydss.ca

USA & Canada Prices Effective May 1, 2021

Inside Escutcheons Part #	Design	Used for following Functions	03/04/09/10/10B/10BL/ 14/15/20D/26/32/32D	
			10BE/26D/BSP/WSP	
77-0736	KE (78)	Blank	\$173.70	\$177.82
81-0556	LE1/3/4 KE1/3/4	Lever Only	\$175.80	\$179.83
77-2300	LE1/3/4 KE1/3/4	Turn Lever Only	\$192.45	\$196.47
81-4645	LE1/3/4 KE1/3/4	Knob/Lever & Turn Lever	\$194.45	\$198.50
77-0062	LE1/KE1	Cyl. Only	\$175.80	\$179.83
81-0559	LE1/KE1	Knob/Lever & Cyl.	\$177.82	\$181.83
77-2951	LE1/KE1	Cyl. & Turn Lever	\$194.45	\$198.50
81-0563	LE2/KE2	Knob/Lever Only	\$175.80	\$179.83
77-3477	LE2/KE2	Turn Lever Only	\$192.45	\$196.47
81-4647	LE2/KE2	Knob/Lever & Turn Lever	\$194.45	\$198.50
77-0742	LE2/KE2	Cyl. Only	\$175.80	\$179.83
81-0562	LE2/KE2	Knob/Lever & Cyl.	\$177.82	\$181.83
77-3473	LE2/KE2	Cyl. & Turn Lever	\$194.45	\$198.50
81-0579	LS/KS	Blank	\$369.74	\$373.81
81-0576	LS/KS	Knob/Lever Only	\$371.76	\$375.79
81-4684	LS/KS	Turn Lever Only	\$388.45	\$392.46
81-4682	LS/KS	Knob/Lever & Turn Lever	\$392.46	\$396.53
81-0581	LS/KS	Cyl. Only	\$371.76	\$375.79
81-0577	LS/KS	Knob/Lever & Cyl.	\$375.79	\$379.83
81-4685	LS/KS	Cyl. & Turn Lever	\$392.46	\$379.83
81-0647	WT (78/82)	Knob/Lever Only	\$121.25	\$125.27
81-4699	WT (78/82)	Turn Lever Only	\$137.87	\$141.93
81-4594	WT (78/82)	Knob/Lever & Turn Lever	\$141.93	\$145.96
81-0651	WT (78/82)	Cyl. Only	\$121.25	\$125.26
81-0648	WT (78/82)	Knob/Lever & Cyl.	\$125.26	\$129.30
81-4698	WT (78/82)	Turn Lever & Cyl.	\$141.93	\$145.96
81-0646	WT(78/82)	Blank	\$119.04	\$123.05
77-3428	LW1/KW1	Knob/Lever Only	\$129.30 (10BE only)	\$133.37
82-1371	LW1/KW1	Knob/Lever Only	\$129.30 (26D only)	-
77-3427	LW1/KW1	Blank	\$129.30 (10BE only)	\$133.37
82-1370	LW1/KW1	Blank	\$129.30 (26D only)	-
77-3435	LW1/KW1	Turn Lever Only	\$145.96	\$149.99
77-3432	LW1/KW1	Knob/Lever & Turn Lever	\$147.97	\$152.04
77-3430	LW1/KW1	Cyl. Only	\$129.30 (10BE only)	\$133.37
82-1373	LW1/KW1	Cyl. Only	\$129.30 (26D only)	-
77-3429	LW1/KW1	Knob/Lever & Cyl.	\$131.35 (10BE only)	\$135.37
82-1372	LW1/KW1	Knob/Lever & Cyl.	\$131.35 (26D only)	-
77-3431	LW1/KW1	Cyl. & Turn	\$131.35	\$135.37
77-5978	LW1/KW1	Cyl & Lever (31, 35, 36)	\$131.35 (10BE only)	\$135.37 (32 & 32D only)
77-1486	LW1/KW1	Cyl & Lever (31, 35, 36)	\$131.35 (26D only)	\$135.37 (N/A with 32 & 32D)

ML-114 MORTISE LOCKS

SARGENT®

8200 - INSIDE ESCUTCHEONS

ASSA ABLOY

USA & Canada Prices Effective May 1, 2021

Inside Coastal Series Escutcheons				03/04/09/10/10B/10BL/
Part #	Design	Used for Functions	10BE/26D/BSP/WSP	14/15/20D/26
82-0544	CE	Lever Only	\$214.17	\$255.36
82-0546	CE	Cyl. Only	\$214.17	\$255.36
82-0547	CE	Lever & Cyl.	\$216.24	\$257.44
82-0548	CE	Blank-Dummy	\$212.12	\$253.31
82-3907	CE	Turn Lever Only	\$231.13	\$272.33
82-3909	CE	Lever & Turn Lever	\$233.22	\$274.41
82-3911	CE	Cyl. & Turn Lever	\$233.22	\$274.41
82-0514	TE	Blank	\$212.12	\$253.31
82-0560	TE	Lever Only	\$214.17	\$255.36
82-0562	TE	Cyl. Only	\$214.17	\$255.36
82-0563	TE	Lever & Cyl.	\$216.24	\$257.44
82-0564	TE	Blank-Dummy	\$212.12	\$253.31
82-3908	TE	Turn Lever Only	\$231.13	\$272.33
82-3910	TE	Lever & Turn Lever	\$233.22	\$274.41
82-3912	TE	Cyl. & Turn Lever	\$233.22	\$274.41

Studio Collection Inside Escutcheons				03/04/09/10/10B/10BL/
Part #	Design	Used for Functions	10BE/26D/BSP/WSP	14/15/20D/26/32/32D
77-0062	LE1	Cylinder Only	\$175.80	\$179.83 (09, 32D)
77-0736	LE1	Blank	\$173.70	\$177.82 (09, 32D)
82-0936	LE1	Cylinder & Lever	\$181.23	\$185.36 (09, 32D)
82-0937	LE1	Lever Only	\$179.15	\$183.29 (09, 32D)
82-4594	LB-LE1	Turn ADA & Lever	\$210.30	\$214.46 (09, 32D)
77-2300	LE1	Turn Only	\$192.45	\$196.47 (09, 32D)
77-2951	LE1	Cylinder and Turn	\$194.45	\$198.50 (09, 32D)
82-3817	LB-LE1	Cylinder & Turn ADA	\$210.30	\$214.46 (09, 32D)
82-3821	LB-LE1	Turn ADA	\$208.25	\$212.37 (09, 32D)
82-4586	LE1	Turn & Lever	\$198.19	\$202.32
82-0546	CE	Cylinder Only	\$214.17	\$255.36
82-0548	CE	Blank	\$212.12	\$253.31
82-0924	CE	Cylinder & Lever	\$216.24	\$257.44
82-0925	CE	Lever Only	\$214.17	\$255.36
82-4589	LB-CE	Turn ADA & Lever	\$245.35	\$286.52
82-3907	CE	Turn Only	\$231.13	\$272.33
82-3911	CE	Cylinder and Turn	\$233.22	\$274.41
82-4010	LB-CE	Turn ADA	\$243.26	\$284.43
82-4014	LB-CE	Cylinder and Turn ADA	\$243.26	\$284.43
82-4587	CE	Turn & Lever	\$233.22	\$274.41
82-0562	TE	Cylinder Only	\$214.17	\$255.36
82-0564	TE	Blank	\$212.12	\$253.31
82-0930	TE	Cylinder & Lever	\$216.24	\$257.44
82-0931	TE	Lever Only	\$214.17	\$255.36
82-4590	LB-TE	Turn & Lever ADA	\$245.35	\$286.52
82-3908	TE	Turn Only	\$231.13	\$272.33
82-3912	TE	Cylinder and Turn	\$233.22	\$274.41
82-4011	LB-TE	Turn ADA	\$243.26	\$284.43
82-4015	LB-TE	Cylinder and Turn ADA	\$245.35	\$286.52
82-4588	TE	Turn & Lever	\$233.22	\$274.41

Experience a safer
and more open world

Copyright © 2002-2021 Sargent Manufacturing Company, an ASSA ABLOY Group company. All rights reserved.
Reproduction in whole or in part without the express written permission of Sargent Manufacturing Company is prohibited.
Contact us at: 800-727-5477 or visit www.sargentlock.com. In Canada contact us at: 800-461-3007 or visit www.assaabloydss.ca

Outside Escutcheons Part #	Design	Used for following Functions	10BE/26D/BSP/WSP	03/04/09/10/10B/10BL/ 14/15/20D/26/32/32D
81-0552	LE1/2/3/4 KE1/2/3/4	Lever Only	\$175.80	\$179.83 (09 only)
81-4642	LE1/2/3/4 KE1/2/3/4	Knob/Lever & Emerg. Rel.	\$194.45	\$198.50 (09 only)
81-0559	LE1/2 KE1/2	Cyl. Only	\$177.82	\$181.83 (09 only)
81-0557	LE1/2 KE1/2	Knob/Lever & Cyl.	\$177.82	\$181.83 (09 only)
77-0062	LE1/KE1	20	\$175.80	\$179.83
81-0559	LE1/KE1	31-35-36	\$177.82	\$181.83
77-0742	LE2/KE2	20	\$175.80	\$179.83
81-0562	LE2/KE2	31-35-36	\$177.82	\$181.83
77-0738	LE3/4 KE3/4	06-91-03-21	\$175.80	\$179.83 (09 only)
81-0560	LE3/4 KE3/4	04-05-37-70-71- 24-25-43-45-50	\$177.82	\$181.83 (09 only)
77-1211*	LE3/KE3	20	\$175.80	\$179.83
81-0555*	LE3/KE3	31-35-36	\$177.82	\$181.83
77-1207*	LE4/KE4	20	\$175.80	\$179.83
81-0558*	LE4/KE4	31-35-36	\$177.82	\$181.83
81-0584	LS/KS	Knob/Lever Only	\$371.76	\$375.79 (09 only)
81-4681	LS/KS	Knob/Lever & Emerg.	\$392.46	\$396.53 (09 only)
81-0585	LS/KS	Cyl. Only	\$371.76	\$375.79 (09 only)
81-0586	LS/KS	Knob/Lever & Cyl.	\$375.79	\$379.83 (09 only)
81-0587	LS/KS	Knob/Lever, Cyl., & Ind.	\$377.83	\$379.83 (04, 10, 10B only)
81-0574	LS/KS	Blank	\$369.74	\$373.81 (09 only)

*Please specify finish.

8200 Studio Collection Outside Escutcheons Part #	Design	Used for Functions	10BE/26D/BSP/WSP	03/04/09/10/10B/10BL/ 14/15/20D/26/32/32D
77-0559	LE1	Cylinder Only	\$175.80	\$179.83
82-0939	LE1	Cylinder & Lever	\$181.23	\$185.36
82-0940	LE1	Lever Only	\$179.15	\$183.29
82-4593	LE1	Lever & Emergency Release	\$198.19	\$202.32
82-0555	CE	Cylinder Only	\$214.17	\$255.36
82-0927	CE	Cylinder & Lever	\$216.24	\$257.44
82-0928	CE	Lever Only	\$214.17	\$255.36
82-4584	CE	Lever & Emergency Release	\$233.22	\$274.41
82-0571	TE	Cylinder Only	\$214.17	\$255.36
82-0933	TE	Cylinder & Lever	\$216.24	\$257.44
82-0934	TE	Lever Only	\$214.17	\$255.36
82-4585	TE	Lever & Emergency Release	\$233.22	\$274.41

ML-116 MORTISE LOCKS

SARGENT®

8200/7800—OUTSIDE ESCUTCHEONS

ASSA ABLOY

USA & Canada Prices Effective May 1, 2021

Outside Escutcheons			10BE/26D/BSP/WSP	03/04/09/10/10B/10BL/ 14/15/20D/26/32/32D
Part#	Design	Used for following Functions		
77-3448	LW1/KW1	Knob/Lever Only	\$131.82 (10BE only)	\$135.94
82-1364	LW1/KW1	Knob/Lever Only	\$131.82 (26D only)	-
77-3454	LW1/KW1	Knob/Lever & Emerg. Rel.	\$150.81	\$155.00
77-3450	LW1/KW1	Cyl. Only	\$131.82 (10BE only)	\$135.94
82-1366	LW1/KW1	Cyl. Only	\$131.82 (26D only)	-
77-3449	LW1/KW1	Knob/Lever & Cyl.	\$133.89 (10BE only)	\$137.98
82-1365	LW1/KW1	Knob/Lever & Cyl.	\$133.89 (26D only)	-
77-3430	LW1/KW1	20	\$131.82	\$135.94
77-5978	LW1/KW1	31-35-36	\$133.89	\$137.98
81-0647	WT (78/82)	Knob/Lever Only	\$123.56	\$127.68
81-4593	WT (78/82)	Knob/Lever & Turn Lever	\$144.67	\$148.77
81-0651	WT (78/82)	Cyl. Only	\$123.56	\$127.68
81-0648	WT (78/82)	Knob/Lever & Cyl.	\$127.68	\$131.82
81-0646	WT (78/82)	Blank	\$121.34	\$125.42

Outside Coastal Series Escutcheons			10BE/26D/BSP/WSP	03/04/09/10/10B/10BL/ 14/15/20D/26
Part#	Design	Used for following Functions		
82-0536	CE	Lever & Cyl.	\$216.24	\$257.44
82-0546	CE	20	\$214.17	\$255.36
82-0547	CE	31, 35, 36	\$216.24	\$257.44
82-0553	CE	Lever Only	\$214.17	\$255.36
82-0555	CE	Cyl. Only	\$214.17	\$255.36
82-3913	CE	Lever & Emerg. Rel.	\$233.22	\$274.41
82-0538	TE	Lever & Cyl.	\$216.24	\$257.44
82-0562	TE	20	\$214.17	\$255.36
82-0563	TE	31, 35, 36	\$216.24	\$257.44
82-0569	TE	Lever Only	\$214.17	\$255.36
82-0571	TE	Cyl. Only	\$214.17	\$255.36
82-3914	TE	Lever & Emerg. Rel.	\$233.22	\$274.41

Retrofit kits are available for existing applications.

Sectional Trim:

Each kit includes single side indicator plate with mechanism, screw pack, plastic temple and instructions. To order retrofit kits, specify by model number. Door thickness, handing and indicator option code must also be specified with kit. Retrofit kits with directional engraving must include lock handing.

Sectional Trim Retrofit Kits for V Series Indicators:

Model#	Description	List Price
SA190	Keyed for use with the following functions: 20, 21, 22, 24, 25, 26, 28, 29, 30, 39, 40, 41, 43, 45, 46,47, 50, 51, 52, NAC-PHR-82281	
SA191	Keyed for use with the following functions: 05, 36, 37, 56, 57, 58, 67	
SA192	Keyed for use with the following functions: 38, 59	
SA193	Cointurn for use with the following functions: 65, 66, 68	\$215.00
SA194	Thumbturn for use with the following functions: 21, 24, 25, 28, 43, 45, 47, 50, 51, 66, 68, NAC-PHR-82281, NAC-PHR-82285	
SA196	Thumbturn for use with the following functions: 05, 56, 57, 58, 65, 67	
SA197	No Input - Blank for use with the following functions: 30, 37, NAC-PHR-82285	

Note: When ordering sectional trim retrofit kits, specify finish, hand and V code required. i.e. SA190 x RH x 26D x V01

Cylinders not included. Kits accommodate indicators on one side of the door only. If indicators are required for both sides, 2 kits must be ordered as required by function. For escutcheon retrofit kits, see pages XX for pricing, add for indicator option also applies. Escutcheon kits must include line item for both IS and OS.

Escutcheon Trim

Retrofit kits are available as complete trim packs for existing applications. Trim pack includes levers and escutcheons with mechanism for both sides of door, screw pack, door marker and instructions. Inside and outside trim must be ordered together as separate items. Specify by adding option code IS/OS to complete order string. See pages ML-1A for pricing.

Experience a safer
and more open world

Copyright © 2002-2021 Sargent Manufacturing Company, an ASSA ABLOY Group company. All rights reserved.
Reproduction in whole or in part without the express written permission of Sargent Manufacturing Company is prohibited.
Contact us at: 800-727-5477 or visit www.sargentlock.com. In Canada contact us at: 800-461-3007 or visit www.assaabloydss.ca

7800/8200 Standard Rose Design (Same for inside & outside)			
Part #	Design	10BE/26D/BSP/WSP	03/04/09/10/10B/10BL/14/15/20D/26/32/32D
695E	E		
695L	L	\$54.00	\$62.00
695LN	LN	\$48.00	\$52.00
695O	O	\$49.00	\$53.00
7800/8200 Studio Collection Rose Design (Same for inside & outside)			
Part #	Design	10BE/26D/BSP/WSP	03/04/09/10/10B/10BL/14/15/20D/26/32/32D
696LN	LN	\$48.00	\$52.00
696CR	CR		\$113.00
696TR	TR	\$68.00	
696O	O	\$49.00	\$53.00
696CO	CO		
696TO	TO	\$68.00	\$113.00
696E2	E2 - Supplied Inside and Outside Rose		
696E3	E3 - Supplied Inside and Outside Rose		
696E4	E4 - Supplied Inside and Outside Rose		
R8200 Collar Design (Same for inside & outside)			
Part #	Design	10BE/26D/BSP/WSP	03/04/09/10/10B/10BL/14/15/20D/26/32/32D
697R1	MA, ME, MF, MG, MI, MO, MU, MZ, NU		
697R2	MJ, MQ, MS, MV, MX, MY, NJ, NS		
697R3	MB, MD, MH, MW, ND	\$66.00	\$111.00
697R4	MM, G, R, S, Y		
Note: Must specify lever design when ordering collar			
7800 Emergency Release/Thumb Turns			
Part #	Design	10BE/26D/BSP/WSP	03/04/09/10/10B/10BL/14/15/20D/26/32/32D
184W	Outside Emergency Release	\$63.00	\$74.00
184KA	Outside Emergency Release	\$113.00	\$123.00
126	Thumbturn Lever (7891 & 7892 function only)		
130W	Thumbturn Lever	\$63.00	\$74.00
8200 Emergency Release/Thumb Turns			
Part #	Design	10BE/26D/BSP/WSP	03/04/09/10/10B/10BL/14/15/20D/26/32/32D
184KB	Outside Emergency Release		
130KB	Thumbturn Lever		
130KBCVR	Thumbturn Cover	\$60.00	\$63.00
130KBT1	Decorative T1 Thumbturn on round backplate		
130KBT2	Decorative T2 Thumbturn on round backplate		
130KBT3	Decorative T3 Thumbturn on round backplate		
130LB	Thumbturn Lever - Large ADA	\$78.00	\$90.00
8200 Coastal Series Rose Design (Same for inside & outside)			
Part #	Design	10BE/26D/BSP/WSP	03/04/09/10/10B/10BL/14/15/20D/26/32/32D
695TR	TR	\$68.00	\$113.00
695CR	CR		
8200 Coastal Series Metro Element Emergency Release/Thumb Turns			
Part #	Design	10BE/26D/BSP/WSP	03/04/09/10/10B/10BL/14/15/20D/26/32/32D
184KC	Outside Emergency Release - Contemporary	\$68.00	\$74.00
184KT	Outside Emergency Release - Traditional		
130KC	Thumbturn Lever - Contemporary		
130KCT1	Dec. T1 Thumbturn on contemporary backplate	\$68.00	\$74.00
130KCT2	Dec. T2 Thumbturn on contemporary backplate		
130KCT3	Dec. T3 Thumbturn on contemporary backplate		
130KT	Thumbturn Lever - Traditional		
130KTT1	Dec. T1 Thumbturn on traditional backplate	\$68.00	\$74.00
130KTT2	Dec. T2 Thumbturn on traditional backplate		
130KTT3	Dec. T3 Thumbturn on traditional backplate		
130LC	Thumbturn Lever - Large ADA - Contemporary	\$90.00	\$100.00
130LT	Thumbturn ADA version		
130KA	Thumbturn Lever - Used with E Rose		
130KAT1	Dec. T1 Thumbturn on square backplate	\$212.00	\$235.00
130KAT2	Dec. T2 Thumbturn on square backplate		
130KAT3	Dec. T3 Thumbturn on square backplate		
7800/8200 Indicators			
Part #	Design	10BE/26D/BSP/WSP	03/04/09/10/10B/10BL/14/15/20D/26/32/32D
185C	Visual Indicator (49-)	\$120.00	\$130.00
Note: Used with 30, 36, 37 function			
- 7800 & 8200 Rose Trims: CR, L, LN, TR, E, O Used with 26, 29, 38, 39, 40, 41 function - Rose Trim 8200 LN			
185P	Occupancy Indicator (49-)	\$120.00	\$130.00
Note: Used with 65, 66, 68 functions Rose Trim 7800 & 8200 CR, E, L, LN, O, TR			
185S-1	Secured Indicator Rose (1-3/8" thick door) (50-)		
185S-2	Secured Indicator Rose (1-3/4" thick door) (50-)	\$120.00	\$130.00
185S-3	Secured Indicator Rose (2" thick door) (50-)		
185S-4	Secured Indicator Rose (2-1/4" thick door) (50-)		
Note: Used with 24, 25, 26, 28, 29, 30, 36, 37, 38, 39, 40, 41, 43, 45, 50, 51, 52, 67 functions - all Rose type trims only.			
Note: When ordering with lock, specify 49 or 50 option.			

ML-118 MORTISE LOCKS

SARGENT®

ASSA ABLOY

7800/8200 – MOUNTING KITS

USA & Canada Prices Effective May 1, 2021

7800/8200 Anti-Vandal Pull trims – Available with all Trims except LS/KS, FE, PT

Part #	Description	32D
667-1	RHRB Pull for 04, 06, 17, 28, 29, 30, 31, 50, 51, 52, 91, 92 functions	
667-2	LHRB Pull for 04, 06, 17, 28, 29, 30, 31, 50, 51, 52, 91, 92 functions	
667-3	RHRB Pull for 03, 20, 21, 22, 23 functions	
667-4	LHRB Pull for 03, 20, 21, 22, 23 functions	\$516.00
667-5	RHRB Pull without Lip for inactive door	
667-6	LHRB Pull without Lip for inactive door	

Note: When ordering with lock, specify AV option.

8200 Inside Trim Kit (04/05/15/16/17/24/25/26/37/43/45/50/65/66/70/71/72/73/85/86/94 functions)

Part #	Description	Price
82-3212	CE, KS, LE (1-4), TE, LS - 1 3/4", 2" Door	\$55.96
82-3873	CE, KS, LE (1-4), TE, LS - 2 1/4" Door	\$67.96
82-3211	CR, TR, LN, LW1, O - 1 3/4", 2" Door	\$55.96
82-3874	CR, TR, LN, LW1, O - 2 1/4" Door	\$67.96
82-3213	L, WT - 1 3/4", 2" Door	\$56.90
82-3875	L, WT - 2 1/4" Door	\$67.96

8200 One-Side Trim Kit (06/13/31/35/36/91/92/95 functions)

Part #	Description	Price
82-3208	LN, E, O, CR, TR Rose/LW1, KW1 Esc. - 1 3/4" Door	\$60.49
82-3209	LE, KE (1,2,3,4), CE, TE Esc. - 1 3/4" Door	\$61.63
82-3210	L Rose, WT Esc. - 1 3/4" Door	\$62.51
82-3214	LS, KS - 1 3/4" Door	\$58.21

8200 Outside Trim Kit

Part #	Description	Price
82-3876	CE, KS, LE (1-4), TE, LS - 1 3/4" Door	\$28.83
82-3877	CE, KS, LE (1-4), TE, LS - 2" Door	\$35.03
82-3878	CE, KS, LE (1-4), TE, LS - 2 1/4" Door	\$39.16
82-3879	CR, TR, LN, LW1, O - 1 3/4" Door	\$28.83
82-3880	CR, TR, LN, LW1, O - 2" Door	\$35.03
82-3881	CR, TR, LN, LW1, O - 2 1/4" Door	\$39.16
82-3882	L, WT - 1 3/4" Door	\$28.83
82-3883	L, WT - 2" Door	\$35.03
82-3884	L, WT - 2 1/4" Door	\$39.16

8200 Complete Trim Kit

Part #	Description	Price
82-3885	CE, KS, LE (1-4), TE, LS - 1 3/4" Door	\$84.45
82-3886	CE, KS, LE (1-4), TE, LS - 2" Door	\$90.63
82-3887	CE, KS, LE (1-4), TE, LS - 2 1/4" Door	\$107.11
82-3888	CR, TR, LN, LW1, O - 1 3/4" Door	\$84.45
82-3889	CR, TR, LN, LW1, O - 2" Door	\$90.63
82-3890	CR, TR, LN, LW1, O - 2 1/4" Door	\$107.11
82-3891	L, WT - 1 3/4" Door	\$84.45
82-3892	L, WT - 2" Door	\$90.63
82-3893	L, WT - 2 1/4" Door	\$107.11

8200 10 Pack - Complete Trim Kit

Part #	Description	Price
82-3894	CE, KS, LE (1-4), TE, LS - 1 3/4" Door	\$844.36
82-3895	CE, KS, LE (1-4), TE, LS - 2" Door	\$906.14
82-3896	CE, KS, LE (1-4), TE, LS - 2 1/4" Door	\$1,070.89
82-3897	CR, TR, LN, LW1, O - 1 3/4" Door	\$844.36
82-3898	CR, TR, LN, LW1, O - 2" Door	\$906.14
82-3899	CR, TR, LN, LW1, O - 2 1/4" Door	\$1,070.89
82-3900	L, WT - 1 3/4" Door	\$844.36
82-3901	L, WT - 2" Door	\$906.14
82-3902	L, WT - 2 1/4" Door	\$1,070.89

8200 Studio Collection Inside trim Kit (04, 05, 15, 16, 17, 24, 25, 26, 37, 43, 45, 50, 65, 66, 70, 71, 72, 83, 85, 86, 94 functions)

Part #	Rose/Eschutcheon Description	Price
79-2162	O,CO,CR,LN,TO,TR Roses and LW1, WT Escutcheons	\$30.47

8200 Studio Collection One Side Trim Kit (06,13,31,35,36,91,92,95 functions)

Part #	Rose/Eschutcheon Description	Price
79-2161	O,CO,CR,LN,TO,TR Roses and LW1, WT Escutcheons	\$45.78
79-2159	O,CO,CR,LN,TO,TR (93 function only)	\$31.75
79-2160	O,CO,CR,LN,TO,TR (94 function only)	\$32.07

Experience a safer
and more open world

Copyright © 2002-2021 Sargent Manufacturing Company, an ASSA ABLOY Group company. All rights reserved.
Reproduction in whole or in part without the express written permission of Sargent Manufacturing Company is prohibited.
Contact us at: 800-727-5477 or visit www.sargentlock.com. In Canada contact us at: 800-461-3007 or visit www.assaabloydss.ca

8200 STRIKES & RABBETED KITS 8100 SPINDLES

USA & Canada Prices Effective May 1, 2021

Strikes Part #		Price
77-1141	Wrought Box (Steel) ordered w/locks	N/A
77-1141	Wrought Box (Steel) ordered separately	\$12.00
78-0034	Deadlock Strike - No Lip	\$23.00
82-0229	Straight Lip Strike - 7/8" Lip	\$29.00
82-0109	Curved Lip Strike - 1 1/8"	\$29.00
82-0110	Curved Lip Strike 1 1/4" Lip Length-Standard	\$29.00
82-0111	Curved Lip Strike 1 3/8" Lip Length	\$29.00
82-0112	Curved Lip Strike 1 5/8" Lip Length	\$29.00
82-0113	Curved Lip Strike 1 7/8" Lip Length	\$29.00
82-0114	Curved Lip Strike 2 1/8" Lip Length	\$29.00
82-0115	Curved Lip Strike 2 3/8" Lip Length	\$29.00
82-0116	Curved Lip Strike 2 5/8" Lip Length	\$29.00
82-0117	Curved Lip Strike 2 7/8" Lip Length	\$29.00

877 Back Strikes Part #		Price
82-0332	RHRB - 1 3/4" Dr Thickness	\$121.00
82-0333	LHRB - 1 3/4" Dr Thickness	\$121.00
82-0334	RHRB - 2" Dr Thickness	\$138.00
82-0335	LHRB - 2" Dr Thickness	\$138.00
82-0336	RHRB - 2 1/4" Dr Thickness	\$150.00
82-0337	LHRB - 2 1/4" Dr Thickness	\$150.00
82-0338	RHRB - 2 1/2" Dr Thickness	\$164.00
82-0339	LHRB - 2 1/2" Dr Thickness	\$164.00
82-0340	RHRB - 2 3/4" Dr Thickness	\$176.00
82-0341	LHRB - 2 3/4" Dr Thickness	\$176.00
82-0342	RHRB - 3" Dr Thickness	\$189.00
82-0343	LHRB - 3" Dr Thickness	\$189.00

Note: Lock must be centered in door.

7800-8200 - Rabbeted Front Kit - Function required when ordering			
Part #	Design	26D	03/04/09/10/10BL/14/15/20D/26
677	for 1 3/4" to 2" Doors	\$205.00	\$234.00
2-677	for 2 1/4" Doors	\$205.00	\$234.00

8100 Spindle Kits (Ball & Socket)			
Kit Number	Rose/Esc. Design	Door Thickness	Price
Spindle Kits for 8100's mfg. prior to 1/1/90			
578-1	LN, LE, LW	1-3/8"	\$42.00
578-2	LN, LE, LW	1-3/4"	\$42.00
578-3	LN, LE, LW	2-1/4"	\$42.00
Spindle Kits for 30-8100 mfg. after 1/1/90			
579-1	LN, LE, LW	1-3/8"	\$42.00
579-2	LN, LE, LW	1-3/4"	\$42.00
579-3	LN, LE, LW	2-1/4"	\$42.00

Kit includes: Pre-drilled spindle assembly, 2 grub screws, 2 bushings, spiral pin, spindle cavity template.
Please specify door thickness, rose or escutcheon and lever or knob design.

8100 Thru-Bolt Spindles		Price
10-0195	Inside Spring, Outside Spring	\$0.84
81-0618	For 1-3/8" Door – Inside/Outside Spindle	\$37.45
81-0524	For 1-3/4" Door – Inside/Outside Spindle	\$37.45
81-0619	For 2-1/4" Door – Inside/Outside Spindle	\$37.45

ML-120 MORTISE LOCKS

SARGENT®

8200/7800 PARTS

ASSA ABLOY

USA & Canada Prices Effective May 1, 2021

Part No.		Price
01-0010	PT-Trim Retaining Ring	\$0.95
01-0079	Washer/Shim - Inside & Outside	\$0.95
01-0203	Retaining Ring (for deadbolt & assy.)	\$0.95
01-0972	PT-Trim Cotter Pin	\$2.42
*01-1019	12-24 x 1/2 PH Screw (for strikes)	\$0.86
*01-1028	8-32 x 1/4 PH Screw (for O/S fronts)	\$0.85
01-1071	Mounting Screws for 130/184 KA, KB, KC, KT, LB, LC, LT (MS)	\$1.34
*01-1119	Machine Screw #8-82 x 1-1/2" PH HD	\$1.60
*01-1154	Screw for 130/184 KA, KB, KC, KT, LB, LC, LT (#6-32 x 1/4")	\$1.54
01-1161	Set Screw	\$0.99
01-1174	Lever/Knob Screw for B/J/L/P/W/C/G/ R/S/Y Lever-B/C Knob	\$3.08
*01-1257	#8-32 x 3/4 CS FL Spanner	\$9.26
*01-1261	#6-32 x 5/16 FT MS Spanner	\$6.36
*01-1262	6-32 x 1/4 FT MS Spanner	\$6.36
*01-1272	6-32 x 3/8 FL MS Spanner	\$4.70
*01-1273	8-32 x 1/4 FL MS Spanner	\$4.56
*01-1282	12-24 x 1/2 FL MS Spanner	\$4.71
*01-1283	#12 x 1" FT WS Spanner	\$5.92
*01-1285	1/4-20 x 1 3/4 MS Spanner	\$8.23
*01-1290	1/4-20 x 2" MS Spanner	\$8.48
*01-1362	#8-32 x 3/4 CS Flt Torx	\$3.58
*01-1366	#6-32 x 5/16 FT MS Torx	\$4.48
*01-1367	#6-32 x 1/4 FT MS Torx	\$4.87
*01-1377	PT-Trim Torx Screw	\$7.01
*01-1378	#8-32 x 1/4 FTMS Torx	\$6.62
*01-1387	#12-24 x 1/2 FTMS Torx	\$4.70
*01-1388	#12 x 1 FT wood screw	\$7.79
*01-1390	1/4 - 20 x 1 1/4 MS Flt Torx	\$7.48
*01-1395	1/4 - 20 x 2 MS Flt Torx	\$7.84
*01-1472	Lever/Knob Screw for A/E/F Lever	\$3.08
01-1489	FW-Trim Screw & Washer - #10-32 5/16"	\$0.96
01-1491	6 x 3/8" wood screw	\$0.21
01-1495	Thru-bolt Screws - All Trims	\$0.95
*01-2034	6 x 3/8" PH wood screw	\$0.95
*01-2035	6 x 1/2" PH wood screw	\$0.95
*01-2037	6 x 3/4" PH wood screw	\$1.80
01-2217	Mounting Screws for 130/184 W (WS)	\$1.39
*01-2298	#12 x 1 1/4" wood screw (for strike)	\$0.81
01-2299	#12 x 1 1/4" wood screw (for lockbody)	\$0.48
*01-3151	Screw for 130/184 W (#6-32 x 5/16")	\$1.33
01-3157	6-32 x 3/4" PH M.S.	\$1.33
*01-3457	1/4 - 20 x 2 PH	\$1.34
01-4370	Screw for 130/184 KA, KB, KC, KT, LB, LC, LT (#6-32 x 5/16")	\$0.40
01-4376	Screw for hold cable clamp	\$0.66
01-4402	8-32 x 5/16" Machine Screw	\$0.54
*01-4405	Lever/Knob Screw - Torx - A/E/F	\$4.71

Part No.		Price
01-4457	FW-Trim Cap Screw #10-32 x 3/8" (hex hd)	\$5.45
01-4510	PT-Trim Truss Head M.S. 12-24 x 1/4"	\$2.42
01-4511	Flt. Hd. Mach Screw 12-24 x 1-7/8"	\$2.42
01-4532	Self Tapping Screw	\$0.93
*01-5000	Machine Screw (LE2, LE4 Esc.)	\$0.89
01-9180	Catch Screw	\$0.30
06-0183	Escutcheon spring clip	\$22.21
06-0216	Sitker (escutcheon clip)	\$0.57
14-0057	Emergency Key (65 function)	\$1.86
52-2647	Switch & Bracket Assy (LX)	\$147.76
77-0166	8-32 x 2-3/4 PH FL HD LG ES	\$14.89
*77-0168	Machine Screw (LE1 Esc.)	\$1.74
77-0258	Neoprene Washer	\$0.33
77-0734	Bushing Locator	\$5.95
77-1467	8-32 x 2" PH Screw	\$2.34
77-2744	Esc. Screw Pk LE/KE (2,4) Trim One Side	\$11.25
*77-3467	Esc. Screw Pk LE/KE (2,4) 1 3/8" Door	\$12.48
*77-3468	Esc. Screw Pk LE/KE (2,4) 1 3/4" Door	\$12.76
*77-3469	Esc. Screw Pk LE/KE (2,4) 2" Door	\$14.04
*77-3470	Esc. Screw Pk LE/KE (2,4) 2 1/4" Door	\$22.17
77-3886	Spindle assy (knb set) 30-77	\$23.81
*77-4158	Esc. Screw Pk LE/KE(1,3), LW1/KW1, CE, TE - Trim One Side	\$4.92
*77-4230	Cyl. Ret. Cap Pack	\$66.64
*77-4236	Standard Screw Pack for Strike, Front & Lockbody	\$6.07
*77-4251	Esc. Screw Pk LS - 1 3/4" Door	\$24.32
78-0007	Latch Lever (7800 only)	\$12.17
78-0008	Non-handed Hub (7800 only)	\$19.98
78-0009	Hub Spacer (7800 only)	\$2.96
78-0140	T-Handle Hub Spacer	\$19.98
78-0286	Spacer Stop	\$2.72
78-0292	Retaining Nut only (for WT and Rose trim only)	\$17.26
78-2749	Rose Nut & Wrench Pack (Rose Trim)	\$13.54
*81-0067	FW-Trim Washer (disk) 04,17,31,50,70, 73 only	\$11.62
81-0641	Thrubolts - specify door thickness when ordering	\$11.12
81-0723	Thrubolt Posts (1 3/4" Door)	\$2.10 *
81-0742	Cylinder Plate Only - SA190, SA191, SA192 (Cylinder not included)	\$92.00
*81-0743	Blank/No Input Plate Only - SA197	\$92.00
81-0745	Indicator Spindle Cam-Thumb turn/Coin turn	\$13.00
81-0748	Escutcheon Indicator Backing Plate	\$4.00
81-0749	Indicator Mechanism Retaining Pad (sectional)	\$5.00
81-0750	Sectional Indicator Surface Mount Backing Plate	\$12.00
81-0755	Indicator Spindle Cam - Cylinder / No Input-Blank (1-3/8" door thickness)	\$13.00

*Specify finish required.

Experience a safer
and more open world

Copyright © 2002-2021 Sargent Manufacturing Company, an ASSA ABLOY Group company. All rights reserved. Reproduction in whole or in part without the express written permission of Sargent Manufacturing Company is prohibited. Contact us at: 800-727-5477 or visit www.sargentlock.com. In Canada contact us at: 800-461-3007 or visit www.assaabloydss.ca

ASSA ABLOY

8200/7800 PARTS

USA & Canada Prices Effective May 1, 2021

Part No.		Price
81-0756	Indicator Spindle Cam - Cylinder / No Input-Blank (Std 1-3/4" door thickness)	\$13.00
81-0757	Indicator Spindle Cam - Cylinder / No Input-Blank (2-1/4" door thickness)	\$13.00
81-0756	Indicator Spindle Cam - Cylinder / No Input-Blank (Std door thickness)	\$13.00
81-0758	Indicator Spindle Cam - Cylinder / No Input-Blank - (other door thicknesses *must specify)	\$13.00
81-0811	Indicator Window	\$5.00
*81-2262	Plug Assy for 93 & 94 function	\$72.07
81-4270	Lever Adpt & Screw pk (E,L)	\$14.07
81-4443	Adapter & Plate Assy (LN)	\$14.24
*82-0009	3P-8225 O/S Front	\$152.68
82-0017	Mntg Post - 1 3/8" Door	\$3.58
*82-0080	O/S Front (15, 65)	\$53.36
*82-0081	O/S Front (04, 05, 06, 13, 16, 17, 31, 36, 37, 38, 56, 67)	\$53.36
*82-0082	O/S Front (03, 20, 21, 22, 23, 28, 29, 30)	\$53.36
*82-0083	O/S Front (24, 25, 26, 27, 35, 39, 66, 68)	\$53.36
*82-0084	O/S Front (50, 40, 41, 51, 52)	\$53.36
*82-0085	O/S Front (55)	\$53.36
*82-0086	O/S Front (45, 46, 47, 48)	\$53.36
*82-0087	O/S Front (43)	\$53.36
*82-0088	O/S Front (89, 90, 91, 92)	\$53.36
82-0101	Toggle Button (05, 43, 45, 85)	\$15.46
82-0102	Toggle Spring (05, 43, 45, 85)	\$1.70
82-0120	Hub (spacer)	\$2.84
82-0123	Hub (cap 92 function)	\$76.96
82-0124	Hub (case 92 function)	\$76.96
82-0127	Spacer 1/2" (04, 05, 06, 16, 17, 91, 92)	\$0.95
82-0128	Spacer 7/16" (41, 43, 45, 50)	\$0.95
82-0132	Auto Lock Lever	\$5.12
82-0133	Auto Retract Lever	\$5.12
82-0138	Guard Lever Spring (all functions)	\$1.70
82-0139	Cylinder Latch Lever (04, 06, 16, 37, 31)	\$10.70
82-0144	Deadbolt Spring (03, 20, 21, 22, 23, 24)	\$5.45
82-0149	Hub Core (for thumbturn)	\$14.46
82-0160	Cyl. Latch Lever	\$4.70
82-0161	Spring (classroom)	\$9.26
82-0163	Anti-Vandal Hub	\$3.38
82-0168	Classroom Hub (for thumbturn)	\$17.05
82-0170	Washer	\$2.26
82-0171	Plastic Spacer	\$1.14
82-0184	Retaining Nut/Cap Nut - Outside	\$7.86
82-0202	FW-Trim Adapter Only - I/S Lever	\$17.05
82-0203	FW-Trim Adapter Only - I/S Knob	\$17.05
82-0208	Lead Lining (lockbody sleeve)	\$556.06
82-0211	Locking Piece Jamb (04, 17, 31, 50)	\$8.05
82-0212	Toggle Button Washer - 2 per lock	\$1.33
*82-0235	1-Option O/S Front (15, 65)	\$53.36

Part No.		Price
*82-0236	1-Option O/S Front (04, 05, 06, 13, 16, 17, 31, 36, 37, 38, 56, 67,)	\$53.36
*82-0237	1-Option O/S Front (03, 20, 21, 22, 23, 28, 29, 30)	\$53.36
*82-0238	1-Option O/S Front (24, 25, 26, 27, 35, 39, 66, 68)	\$53.36
*82-0239	1-Option O/S Front (40, 41, 50, 51, 52, 97)	\$53.36
*82-0240	1-Option O/S Front (55)	\$53.36
*82-0241	1-Option O/S Front (45, 46, 47, 48)	\$53.36
*82-0242	1-Option O/S Front (43)	\$53.36
82-0251	Washer	\$1.14
82-0347	Lever Spring (put into lever handle)'	\$0.95
82-0367	Spindle for 1-3/8" dr.	\$10.30
82-0368	Spindle for 1-3/4" dr(stndrd)	\$10.30
82-0369	Spindle for 2-1/8" dr.	\$11.06
82-0370	Spindle for 2-1/2" dr.	\$11.06
82-0393	Spring (for guard bolt)	\$1.86
82-0396	Spindle for 93 function - 1-3/4"-2" dr.	\$10.47
82-0397	STR.Spindle (2-1/8"-2-3/8")	\$10.47
82-0399	Spindle for 94 function - 1-3/4"-2" dr.	\$10.47
82-0406	Half Cable Clamp (70, 71, 72, 73)	\$1.02
82-0408	Cylinder Latch Lever	\$0.95
82-0421	Hub (case - 8200)	\$19.13
82-0422	Hub (cap - 8200)	\$19.13
82-0454	FW-Trim Spacer	\$0.67
82-0455	FW-Trim Mounting Plate	\$37.81
82-0456	FW-Trim Thrubolt Stud - (1-3/8" Door)	\$20.76
82-0457	FW-Trim Bushing Insert	\$8.05
*82-0458	FW-Trim O/S Esc. Only-All functions exc. 65,66	\$226.96
82-0459	FW-Trim Spindle Stud - O/S (04,17,31,50, 71,13)	\$6.92
82-0509	Deadbolt Spring (8285)	\$24.72
82-0539	Mntg Post - 2 1/4" Door	\$5.77
82-0541	Spring Bracket	\$15.46
82-0542	Friction Disc	\$13.38
*82-0578	O/S Front (70, 71, 72, 73)	\$53.36
*82-0587	1- O/S Front (89, 90, 91, 92)	\$53.36
*82-0588	1- O/S Front (70, 71, 72, 73)	\$53.36
82-0612	Rose Wave Spring	\$0.93
82-0617	Latch bolt rod	\$1.21
82-0632	Rod support	\$30.13
82-0627	O/S Front (95, 96, 97)	\$36.36
82-0633	LB Tail Clip (65)	\$1.76
82-0691	Outside bushing	\$13.92
82-1038	Lever locking set screw	\$2.08
82-1471	Spindle (2-1/4" door)	\$2.49
82-2004	Spring Cartridge Assembly (8200)	\$19.30
82-2029	Guardbolt Assembly - guarded function	\$8.05
82-2121	Fire Stop Assembly - all functions	\$16.30
82-2122	Cylinder Retainer Assy. (cyl. functions)	\$9.56

ML-122 MORTISE LOCKS

8200/7800 PARTS

USA & Canada Prices Effective May 1, 2021

Part No.	Price
82-3082	Mntg Plate - LN, E, O, CR, TR Rose; LW1, KW1 Esc. \$10.30
82-3085	Mntg Plate - LE/KE(1-4), CE, TE, LS, KS Esc. \$10.30
82-3088	I/S Plate & Adapter-LN, O, E - Rose/LW1 Esc. \$28.09
82-3089	I/S Plate & Adapter-L Rose/WT Esc. \$39.72
82-3090	I/S Plate & Adapter-LE/KW(1,2,3,4), CE, TE, LS Esc. \$53.74
82-3092	Locking Piece Assy. Lock One Lever \$12.16
82-3093	Locking Piece Assy. Lock Both Levers \$10.70
82-3217	Mntg Plate - L Rose, WT Esc. \$10.30
82-3341	Esc. Screw Pk LE/KE(1,3), LW1/KW1, CE1, TE1 - 1 3/4" Door \$26.75
82-3618	Locking Piece (72, 73) \$27.80
82-3645	68/69 -8200 spring ctg asy \$12.03
82-3654	Esc. Screw Pk WT - Wood/Metal Door \$8.05
82-3657	Anti-Vandal Hub Pack \$22.11
82-3662	Interlocking Assy. \$123.02
82-3663	FW-Interlocking Assy (37 function) \$123.02
82-3664	FW-Interlocking Assy (65,66 functions) \$123.02
82-3670	Spindle & Locking Hub \$54.87
82-3671	FW-Spindle (split) Assy - 37 function \$54.87
82-3672	FW-Spindle (split) Assy - 65,66 function \$54.87
82-3675	Escutcheon Screws 1/4-20 x 1 3/4" \$2.26
82-3676	Escutcheon Screws 1/4-20 x 2" \$3.08
*82-3677	FW-O/S Esc. Only- 65,66 functions \$322.59
82-3690	Esc. Screw Pack LE/KE(1,3), LW1/KW1, CE1, TE1 - 1 3/8" Door \$24.49
82-3691	Esc. Screw Pk LE/KE(1,3), LW1/KW1, CE1, TE1 - 2" Door \$27.80
82-3692	Esc. Screw Pk LE/KE(1,3), LW1/KW1, CE1, TE1 - 2 1/4" Door \$35.58
82-3693	Esc. Screw Pk LS - 2" Door \$25.45
82-3694	Esc. Screw Pk LS - 2 1/4" Door \$33.16
82-3736	3P-Fix Device \$163.59
*82-4022	Thru Bolt Blink D'my Plate Assy-1 3/8" Dr. \$48.35
*82-4023	Thru Bolt Blink D'my Plate Assy-1 3/4" Dr. \$48.35
*82-4024	Thru Bolt Blink D'my Plate Assy-2" Dr. \$52.83
*82-4025	Thru Bolt Blink D'my Plate Assy-2 1/4" Dr. \$48.35
82-4051	VAC/OCC Slide asy \$14.13
82-4052	Thumb turn screw pack -for all thumb turn designs (includes: mountig plate, mounting screws (2), and finish screw. \$8.88
82-4180	Deadbolt asy \$44.10
82-4248	Adaptor plate & post asy \$12.32
82-4576	Outside adapter & plate assembly for CO, CR, LN, O, TO, TR \$5.12
82-4577	Inside adapter & plate assembly or CO, CR, LN, O, TO, TR \$18.74
82-4595	Outside adapter & plate assembly for CE, LE1, TE escutcheons \$5.12
82-4596	Inside adapter & plate assembly for CE, LE1, TE escutcheons \$18.73

*Specify finish required.

SARGENT®

ASSA ABLOY

Part No.	Price
82-4600	Trim Pack GBT (2 Sides) Studio \$31.93
82-4611	Trim 1 side pack \$25.66
82-4675	R82 Mounting plate and bushing asy \$40.01
82-5263	Latchbolt assembly \$85.76
82-5577	Indicator Over-travel Cam Ass'y - 38 & 59 functions (Std 1-3/4" door thickness) \$13.00
82-5578	Indicator Over-travel Cam Ass'y - 38 & 59 functions (1-3/8" door thickness) \$13.00
82-5579	Indicator Over-travel Cam Ass'y - 38 & 59 functions (2-1/4" door thickness) \$13.00
82-5580	Indicator Over-travel Cam Ass'y - 38 & 59 functions (2-1/2" door thickness) \$13.00
82-5601	Sectional Indicator Template Kit \$14.00
82-5602	Indicator Display Assembly - Unlocked/Locked, Green/Red \$65.00
82-5603	Indicator Display Assembly - Vacant/Occupied, Green/Red \$65.00
82-5604	Indicator Display Assembly - Unlocked Icon/Locked Icon, Green/Red \$65.00
82-5605	Indicator Display Assembly - Unlocked/Locked, White/Red \$65.00
82-5606	Indicator Display Assembly - Vacant/Occupied, White/Red \$65.00
82-5607	Indicator Display Assembly - Unlocked Icon/Locked Icon, White/Red \$65.00
*82-5587	Escutcheon Indicator Screw Pack - Phillips, 1-3/4" Door \$19.00
*82-5588	Escutcheon Indicator Screw Pack - Phillips, (other door thicknesses *must specify) cut to length \$19.00
*82-5590	Sectional Indicator Screw Pack - Phillips & Torx \$9.00
*82-5630	Thumbturn Plate Only - SA194, SA196 (Ass'y includes std thumbturn) \$92.00
*82-5631	Thumbturn Plate Only - SA194, SA196 (Ass'y includes ADA thumbturn) \$108.00
*82-5632	Thumbturn Plate Only - SA194, SA196 (Ass'y includes T1 thumbturn) \$92.00
*82-5633	Thumbturn Plate Only - SA194, SA196 (Ass'y includes T2 thumbturn) \$92.00
*82-5634	Thumbturn Plate Only - SA194, SA196 (Ass'y includes T3 thumbturn) \$92.00
*82-5635	CoinTurn Plate Only - SA193 (Ass'y includes cointurn) \$92.00
97-0478	FW-Lower Plate \$5.57

Experience a safer
and more open world

Copyright © 2002-2021 Sargent Manufacturing Company, an ASSA ABLOY Group company. All rights reserved. Reproduction in whole or in part without the express written permission of Sargent Manufacturing Company is prohibited. Contact us at: 800-727-5477 or visit www.sargentlock.com. In Canada contact us at: 800-461-3007 or visit www.assaabloydss.ca

USA & Canada Prices Effective May 1, 2021

How to Order

Step	Description	Example
Quantity	Each	10 Ea.
Option	Consult catalog for options available	10 Ea. 75-
Product Series	7900 Levers and Knobs	10 Ea. 75-79
Function	Consult catalog for functions available	10 Ea. 75-7955
Trim	Consult catalog for trims available	10 Ea. 75-7955 OBL
Finish	Consult catalog for finishes available	10 Ea. 75-7955 OBL US26D
Hand	Consult catalog for handing requirements	10 Ea. 75-7955 OBL US26D RH
Options	Consult factory for options available	10 Ea. 75-7955 OBL US26D RH x 1 3/8" Lip Strike
When ordering split finishes specify outside finish first		10 Ea. 75-7955 OBL US3 x US26D RH

To price split trim/finish, defaults to higher price.

Locksets in combinations not listed should be figured by adding together the prices of the component parts.

If by any method of figuring, lower prices can be obtained than set prices shown, set prices will prevail.

It is not permissible to take full deduction for omission of a component from a lockset.

Prices are for 1-3/4" door. For other door thicknesses not listed herein, please consult factory.

ANSI Finish and Function Comparison

Function		Finish		
SARGENT	ANSI	SARGENT	ANSI	Description
15	F01	US3	605	Polished brass, clear coated
55	F04	US4	606	Satin brass, clear coated
37	F05	US9	611	Polished bronze, clear coated
04	F07	US10	612	Satin Bronze, clear coated
16	F09	US10B	613	Oxidized Satin Bronze/Oil Rubbed
45	F12	US10BE	613E	Dark Oxidized Satin Bronze - Equivalent
25	F13	US10BL	---	Oxidized Satin Bronze, clear coated
26	F14	US15	619	Satin nickel, clear coated
50	F15	US14	618	Bright nickel, clear coated
66	F19	US20D	---	Statuary dark bronze, clear coated
43	F20	US26	625	Polished chrome
24	F21	US26D	626	Satin chrome
65	F22	US32	629	Polished stainless steel
38	F32	US32D	630	Satin stainless steel

ML-124 MORTISE LOCKS

SARGENT®

ASSA ABLOY

OPTIONS

USA & Canada Prices Effective May 1, 2021

Options	Description	Price
1▲	7900 Line with 1-1/16" wide front for 1-3/8" doors.	\$62.00
10▲	SARGENT Signature Key System	\$63.00 / cyl.
11†▲	SARGENT XC Key System (not available with 10, 22, SC, SE options)	No addition
1160	SARGENT XC Large Format Interchangeable Plastic Disposable Construction Core	No addition
1163	SARGENT XC Large Format Interchangeable Core Cylinder - Includes masterkeying charges	\$83.00
1164	SARGENT XC Large Format Interchangeable Construction Core Cylinder	\$83.00
1170	Small Format interchangeable disposable construction core - to accept 7 Pin XC permanent core	No addition
11727P	Small Format interchangeable keyed construction core - to accept 7 Pin XC permanent core	\$75.00
11737P	Small Format interchangeable core - to accept 7 pin XC permanent core	\$75.00 / cyl.
21▲†	SARGENT Construction Key System (lost ball) Standard on all new systems established since 5/1/96	\$16.00 / cyl.
22▲†	SARGENT Construction Key System (split key) To be used on pre-established split key systems only	\$32.00 / cyl.
31	Thick Doors - Extended Lip Required - Specify Length C to E	
	- Cylinders - IMPORTANT- See catalog 7800/8200 option page for cylinder limitations	
	- Below charges DO NOT include additional charges for special cylinder requirements	
	Doors up to 2-1/2" thick - lock centered	No addition
	Doors 2-5/8" to 6" thick OR doors 1-3/4" thick w/max 1" paneling one side.	
	For example: Specify 1-3/4" door with panel (Side) on inside or outside	Non Keyed function \$50.00 Keyed function \$100.00
36	6 Lobe security head screws	\$24.00
37	Spanner head screws	\$17.00
60	SARGENT Large Format Interchangeable Plastic Disposable Construction Core	No addition
63	SARGENT Large Format Interchangeable core cylinder, includes master keying charges	\$83.00 / cyl.
64	SARGENT Large Format Interchangeable Construction Core Cylinder	\$83.00
6573▲†	Small Format 6-Pin Uncombined Core (Refer to CK-12)	\$65.00 / cyl.
65737P▲†	Small Format 7-Pin Uncombined Core (Refer to CK-12)	\$65.00 / cyl.
68	7900 Line furnished with lever handle outside x knob inside	Defaults to 7900 Lever Lock Price
69	7900 Line furnished with lever handle inside x knob outside	Defaults to 7900 Lever Lock Price
70▲†	Small Format Interchangeable disposable plastic construction core	No addition
72▲†	Small Format Interchangeable 6-pin construction core (7-pin with 11 options)	\$75.00
73▲†	Small Format interchangeable core 6-pin Includes MK and GMK keying charges	\$75.00 / cyl
737P▲†	Small Format interchangeable core 7-pin (refer to CK-12 for available keyways) Includes MK and GMK keying charges	\$75.00 / cyl
75	Tactile Warning - Milled Inside Lever	\$78.00
76	Tactile Warning - Milled Outside Lever	\$78.00
77	Tactile Warning - Milled Outside and Inside Lever	\$156.00
F182▲†	SARGENT Keso Security Cylinder – patented – new key systems	\$91.00 / cyl.
F183▲†	SARGENT Keso Security Removable Core Cylinder – patented – new key systems	\$130.00 / cyl.
81▲†	Cylinder to accept Keso (83) and Keso F1(F183) Removable Core – no core provided	No addition
82▲†	SARGENT Keso Security Cylinder (For existing systems only)	\$91.00 / cyl.
83▲†	SARGENT Keso Security Removable Core Cylinder (For existing systems only)	\$130.00 / cyl.
84▲†	SARGENT Keso Security Removable Construction Core Cylinder	See CK-18
85	Tactile Warning - Abrasive Coating on Inside Lever	\$49.00
86	Tactile Warning - Abrasive Coating on Outside Lever	\$49.00
87	Tactile Warning - Abrasive Coating on Outside & Inside Lever	\$98.00
BR	SARGENT Bump Resistant Cylinders (N/A w/10, 22, 30, 60, 63, 64, 70, 72, 73, 737P, KESO, SC, & SE options)	\$25.00 /cyl.
DG1	Patented Degree DG1 Key System	No addition
DG160	Hardware prepared for DG1-6300 Lg. Format IC cores, supplied with temporary plastic construction cores	No addition
DG163	Patented Degree DG1 Large Format Interchangeable Core Cylinder - Includes master keying charges	\$83.00
DG164	Hardware prepared for DG1-6300 Lg. Format IC cores, supplied with temporary keyed construction cores	\$83.00
DG2	Patented Degree DG2 Key System incorporating a locking sidebar	\$63.00/cyl.
DG260	Hardware prepared for DG2-6300 Lg. Format IC cores, supplied with temporary plastic construction cores	No addition
DG263	Patented Degree DG2 Large Format Interchangeable Core Cylinder - Includes master keying charges	\$146.00
DG264	Hardware prepared for DG2-6300 Lg. Format IC cores, supplied with temporary keyed construction cores	\$83.00
DG3	Patented Degree DG3 Key System incorporating a locking sidebar and UL437 listed	\$89.00/cyl.
DG360	Hardware prepared for DG3-6300 Lg. Format IC cores, supplied with temporary plastic construction cores	No addition
DG363	Patented Degree DG3 Large Format Interchangeable Core Cylinder - Includes master keying charges	\$172.00
DG364	Hardware prepared for DG3-6300 Lg. Format IC cores, supplied with temporary keyed construction cores	\$83.00
LB	Extra large thumbturn	\$18.00
LC	Less Cylinder	-\$96.00/cyl.
OBS	Open Back Strike	\$79.00
RX	Request to Exit	\$206.00
SC▲†	Schlage "C" Keyway cylinder, (Number 41 Cylinder Only, 0 bitted)	No addition
SE▲†	Schlage "E" Keyway cylinder, (Number 41 Cylinder Only, 0 bitted)	No addition
SG	MicroShield® – an antimicrobial powder coat finish	\$73.00
WBS	Wrought Box Strike	No addition

NOTES: ▲ Options not available with a standard 50 function lockout cylinder. † Not available with 60, 63, 64 options.

CPC 7904 x OBL x RH x 32D x CPC (Clear Powder Coat) \$67.00
All orders will continue to be handled as a "special" when CPC is ordered.

Experience a safer
and more open world

Copyright © 2002-2021 Sargent Manufacturing Company, an ASSA ABLOY Group company. All rights reserved.
Reproduction in whole or in part without the express written permission of Sargent Manufacturing Company is prohibited.
Contact us at: 800-727-5477 or visit www.sargentlock.com. In Canada contact us at: 800-461-3007 or visit www.assaabloydss.ca

USA & Canada Prices Effective May 1, 2021



OBL Lever



OBB Lever



OBP Lever



OBJ Lever

Rose: O (Shown) Levers: BL, BB, BP, BJ (Shown)

Function		Finish	
Single Cyl		10BE/26D/BSP/WSP	03/04/09/10/10B/10BL/14/15/20D/26/32/32D
7904	Storeroom or Closet		
7937	Classroom	\$813.00	\$837.00
7955	Office or Entry		
Single Cyl With Deadbolt			
7924	Room Door		
7925	Dormitory or Exit		
7943	Apartment Corridor	\$833.00	\$857.00
7945	Dormitory or Exit		
7950	Hotel Guest Lock	\$899.00	\$923.00
Double Cyl No Deadbolt			
7916	Apartment or Exit or Public Toilet	\$896.00	\$920.00
7938	Classroom Security Intruder		
Double Cyl With Deadbolt			
7926	Store Door	\$914.00	\$938.00
Electro Mechanical Single Cyl – Specify 12V or 24V			
7970-12V / 7970-24V	Fail Safe	\$1,126.00	\$1,150.00
7971-12V / 7971-24V	Fail Secure		
Electro Mechanical Double Cyl – Specify 12V or 24V			
7972-12V / 7972-24V	Fail Safe	\$1,207.00	\$1,231.00
7973-12V / 7973-24V	Fail Secure		
Non Keyed			
7915	Passage or Closet	\$630.00	\$654.00
7965	Privacy Bedroom or Bath (Latch)	\$733.00	\$757.00
7966	Privacy Bedroom or Bath (Deadbolt)	\$774.00	\$798.00
7993	Single Dummy Trim	\$260.00	\$272.00
7994	Double Dummy Trim	\$523.00	\$547.00
7995	Single Dummy Trim w/Lockbody	\$354.00	\$366.00

ML-126 MORTISE LOCKS

SARGENT®

ASSA ABLOY

OPTIONS

USA & Canada Prices Effective May 1, 2021

Options	Description	Price
1▲	7900 Line with 1-1/16" wide front for 1-3/8" doors.	\$62.00
10▲	SARGENT Signature Key System	\$63.00 / cyl.
11†▲	SARGENT XC Key System (not available with 10, 22, SC, SE options)	No addition
1160	Sargent XC Removable Plastic Disposable Construction Core	No addition
1163	SARGENT XC Large Format Interchangeable Core Cylinder - Includes masterkeying charges	\$83.00
1164	SARGENT XC Large Format Interchangeable Construction Core Cylinder	\$83.00
1170	Small Format interchangeable disposable construction core - to accept 7 Pin XC permanent core	No addition
11727P	Small Format interchangeable keyed construction core - to accept 7 Pin XC permanent core	\$75.00
11737P	Small Format interchangeable core - to accept 7 pin XC permanent core	\$75.00 / cyl.
21▲†	SARGENT Construction Key System (lost ball) Standard on all new systems established since 5/1/96	\$16.00 / cyl.
22▲†	SARGENT Construction Key System (split key) To be used on pre-established split key systems only	\$32.00 / cyl.
31	Thick Doors - Extended Lip Required - Specify Length C to E	
	- Cylinders - IMPORTANT- See catalog 7800/8200 option page for cylinder limitations	
	- Below charges DO NOT include additional charges for special cylinder requirements	
	Doors up to 2-1/2" thick - lock centered	No addition
	Doors 2-5/8" to 6" thick OR doors 1-3/4" thick w/max 1" paneling one side.	
	For example: Specify 1-3/4" door with panel (Side) on inside or outside	Non Keyed function \$50.00 Keyed function \$100.00
36	6 Lobe security head screws	\$24.00
37	Spanner head screws	\$17.00
60	SARGENT Large Format Interchangeable Plastic Disposable Construction Core	No addition
63	SARGENT Large Format Interchangeable core cylinder, includes master keying charges	\$83.00 / cyl.
64	SARGENT Large Format Interchangeable Construction Core Cylinder	\$83.00
6573▲†	Small Format 6-Pin Uncombined Core (Refer to CK-12)	\$65.00 / cyl.
65737P▲†	Small Format 7-Pin Uncombined Core (Refer to CK-12)	\$65.00 / cyl.
68	7900 Line furnished with lever handle outside x knob inside	Defaults to 7900 Lever Lock Price
69	7900 Line furnished with lever handle inside x knob outside	Defaults to 7900 Lever Lock Price
70▲†	Small Format Interchangeable disposable plastic construction core	No addition
72▲†	Small Format Interchangeable 6-pin construction core (7-pin with 11 options)	\$75.00
73▲†	Small Format interchangeable core 6-pin Includes MK and GMK keying charges	\$75.00 / cyl
737P▲†	Small Format interchangeable core 7-pin (refer to CK-12 for available keyways) Includes MK and GMK keying charges	\$75.00 / cyl
75	Tactile Warning - Milled Inside Lever	\$78.00
76	Tactile Warning - Milled Outside Lever	\$78.00
77	Tactile Warning - Milled Outside and Inside Lever	\$156.00
F182▲†	SARGENT Keso Security Cylinder – patented – new key systems	\$91.00 / cyl.
F183▲†	SARGENT Keso Security Removable Core Cylinder – patented – new key systems	\$130.00 / cyl.
81▲†	Cylinder to accept Keso (83) and Keso F1(F183) Removable Core – no core provided	No addition
82▲†	SARGENT Keso Security Cylinder (For existing systems only)	\$91.00 / cyl.
83▲†	SARGENT Keso Security Removable Core Cylinder (For existing systems only)	\$130.00 / cyl.
84▲†	SARGENT Keso Security Removable Construction Core Cylinder	See CK-18
85	Tactile Warning - Abrasive Coating on Inside Lever	\$49.00
86	Tactile Warning - Abrasive Coating on Outside Lever	\$49.00
87	Tactile Warning - Abrasive Coating on Outside & Inside Lever	\$98.00
BR	SARGENT Bump Resistant Cylinders (N/A w/10, 22, 30, 60, 63, 64, 70, 72, 73, 737P, KESO, SC, & SE options)	\$25.00 /cyl.
DG1	Patented Degree DG1 Key System	No addition
DG160	Hardware prepared for DG1-6300 Lg. Format IC cores, supplied with temporary plastic construction cores	No addition
DG163	Patented Degree DG1 Large Format Interchangeable Core Cylinder - Includes master keying charges	\$83.00
DG164	Hardware prepared for DG1-6300 Lg. Format IC cores, supplied with temporary keyed construction cores	\$83.00
DG2	Patented Degree DG2 Key System incorporating a locking sidebar	\$63.00/cyl.
DG260	Hardware prepared for DG2-6300 Lg. Format IC cores, supplied with temporary plastic construction cores	No addition
DG263	Patented Degree DG2 Large Format Interchangeable Core Cylinder - Includes master keying charges	\$146.00
DG264	Hardware prepared for DG2-6300 Lg. Format IC cores, supplied with temporary keyed construction cores	\$83.00
DG3	Patented Degree DG3 Key System incorporating a locking sidebar and UL437 listed	\$89.00/cyl.
DG360	Hardware prepared for DG3-6300 Lg. Format IC cores, supplied with temporary plastic construction cores	No addition
DG363	Patented Degree DG3 Large Format Interchangeable Core Cylinder - Includes master keying charges	\$172.00
DG364	Hardware prepared for DG3-6300 Lg. Format IC cores, supplied with temporary keyed construction cores	\$83.00
LC	Less Cylinder	-\$96.00/cyl.
OBS	Open Back Strike	\$79.00
RX	Request to Exit	\$206.00
SC▲†	Schlage "C" Keyway cylinder, (Number 41 Cylinder Only, 0 bitted)	No addition
SE▲†	Schlage "E" Keyway cylinder, (Number 41 Cylinder Only, 0 bitted)	No addition
SG	MicroShield® – an antimicrobial powder coat finish	\$73.00
WBS	Wrought Box Strike	No addition

NOTES: ▲ Options not available with a standard 50 function lockout cylinder. † Not available with 60, 63, 64 options.

CPC	7904 x LW1BL x RH x 32D x CPC (Clear Powder Coat) All orders will continue to be handled as a "special" when CPC is ordered.	\$67.00
-----	---	---------

Experience a safer
and more open world

Copyright © 2002-2021 Sargent Manufacturing Company, an ASSA ABLOY Group company. All rights reserved.
Reproduction in whole or in part without the express written permission of Sargent Manufacturing Company is prohibited.
Contact us at: 800-727-5477 or visit www.sargentlock.com. In Canada contact us at: 800-461-3007 or visit www.assaabloydss.ca

USA & Canada Prices Effective May 1, 2021



LW1BL Lever



LW1BB Lever



LW1BP Lever



LW1BJ Lever

Escutcheon: LW1 (Shown) Levers: BL, BB, BP, BJ (Shown)

Function		Finish	
		10BE/26D/BSP/WSP	03/04/09/10/10B/10BL/14/15/20D/26/32/32D
Single Cyl			
7904	Storeroom or Closet		
7937	Classroom	\$850.00	\$874.00
7955	Office or Entry		
Single Cyl With Deadbolt			
7924	Room Door		
7925	Dormitory or Exit		
7943	Apartment Corridor	\$872.00	\$896.00
7945	Dormitory or Exit		
7950	Hotel Guest Lock	\$947.00	\$971.00
Double Cyl No Deadbolt			
7916	Apartment or Exit or Public Toilet	\$941.00	\$965.00
7938	Classroom Security Intruder		
Double Cyl With Deadbolt			
7926	Store Door	\$957.00	\$981.00
Electro Mechanical Single Cyl – Specify 12V or 24V			
7970-12V / 7970-24V	Fail Safe	\$1,165.00	\$1,189.00
7971-12V / 7971-24V	Fail Secure		
Electro Mechanical Double Cyl – Specify 12V or 24V			
7972-12V / 7972-24V	Fail Safe	\$1,250.00	\$1,274.00
7973-12V / 7973-24V	Fail Secure		
Non Keyed			
7915	Passage or Closet	\$663.00	\$687.00
7965	Privacy Bedroom or Bath (Latch)	\$769.00	\$793.00
7966	Privacy Bedroom or Bath (Deadbolt)	\$807.00	\$831.00
7993	Single Dummy Trim	\$274.00	\$286.00
7994	Double Dummy Trim	\$547.00	\$571.00
7995	Single Dummy Trim w/Lockbody	\$365.00	\$377.00

ML-128 MORTISE LOCKS

SARGENT®

ASSA ABLOY

OPTIONS

USA & Canada Prices Effective May 1, 2021

Options	Description	Price
1▲	7900 Line with 1-1/16" wide front for 1-3/8" doors.	\$62.00
10▲	SARGENT Signature Key System	\$63.00 / cyl.
11†▲	SARGENT XC Key System (not available with 10, 22, SC, SE options)	No addition
1160	SARGENT XC Large Format Interchangeable Plastic Disposable Construction Core	No addition
1163	SARGENT XC Large Format Interchangeable Core Cylinder - Includes masterkeying charges	\$83.00
1164	SARGENT XC Large Format Interchangeable Construction Core Cylinder	\$83.00
1170	Small Format interchangeable disposable construction core - to accept 7 Pin XC permanent core	No addition
11727P	Small Format interchangeable keyed construction core - to accept 7 Pin XC permanent core	\$75.00
11737P	Small Format interchangeable core - to accept 7 pin XC permanent core	\$75.00 / cyl.
21▲†	SARGENT Construction Key System (lost ball) Standard on all new systems established since 5/1/96	\$16.00 / cyl.
22▲†	SARGENT Construction Key System (split key) To be used on pre-established split key systems only	\$32.00 / cyl.
31	Thick Doors - Extended Lip Required - Specify Length C to E - Cylinders - IMPORTANT- See catalog 7800/8200 option page for cylinder limitations - Below charges DO NOT include additional charges for special cylinder requirements	No addition
	Doors up to 2-1/2" thick - lock centered	No addition
	Doors 2-5/8" to 6" thick OR doors 1-3/4" thick w/max 1" paneling one side. For example: Specify 1-3/4" door with panel (Side) on inside or outside	Non Keyed function \$50.00 Keyed function \$100.00
36	6 Lobe security head screws	\$24.00
37	Spanner head screws	\$17.00
60	SARGENT Large Format Interchangeable Plastic Disposable Construction Core	No addition
63	SARGENT Large Format Interchangeable core cylinder, includes master keying charges	\$83.00 / cyl.
64	SARGENT Large Format Interchangeable Construction Core Cylinder	\$83.00
6573▲†	Small Format 6-Pin Uncombined Core (Refer to CK-12)	\$65.00 / cyl.
65737P▲†	Small Format 7-Pin Uncombined Core (Refer to CK-12)	\$65.00 / cyl.
68	7900 Line furnished with lever handle outside x knob inside	Defaults to 7900 Lever Lock Price
69	7900 Line furnished with lever handle inside x knob outside	Defaults to 7900 Lever Lock Price
70▲†	Small Format Interchangeable disposable plastic construction core	No addition
72▲†	Small Format Interchangeable 6-pin construction core (7-pin with 11 options)	\$75.00
73▲†	Small Format interchangeable core 6-pin Includes MK and GMK keying charges	\$75.00 / cyl
737P▲†	Small Format interchangeable core 7-pin (refer to CK-12 for available keyways) Includes MK and GMK keying charges	\$75.00 / cyl
75	Tactile Warning - Milled Inside Lever	\$78.00
76	Tactile Warning - Milled Outside Lever	\$78.00
77	Tactile Warning - Milled Outside and Inside Lever	\$156.00
F182▲†	SARGENT Keso Security Cylinder – patented – new key systems	\$91.00 / cyl.
F183▲†	SARGENT Keso Security Removable Core Cylinder – patented – new key systems	\$130.00 / cyl.
81▲†	Cylinder to accept Keso (83) and Keso F1(F183) Removable Core – no core provided	No addition
82▲†	SARGENT Keso Security Cylinder (For existing systems only)	\$91.00 / cyl.
83▲†	SARGENT Keso Security Removable Core Cylinder (For existing systems only)	\$130.00 / cyl.
84▲†	SARGENT Keso Security Removable Construction Core Cylinder	See CK-18
85	Tactile Warning - Abrasive Coating on Inside Lever	\$49.00
86	Tactile Warning - Abrasive Coating on Outside Lever	\$49.00
87	Tactile Warning - Abrasive Coating on Outside & Inside Lever	\$98.00
BR	SARGENT Bump Resistant Cylinders (N/A w/10, 22, 30, 60, 63, 64, 70, 72, 73, 737P, KESO, SC, & SE options)	\$25.00 /cyl.
DG1	Patented Degree DG1 Key System	No addition
DG160	Hardware prepared for DG1-6300 Lg. Format IC cores, supplied with temporary plastic construction cores	No addition
DG163	Patented Degree DG1 Large Format Interchangeable Core Cylinder - Includes master keying charges	\$83.00
DG164	Hardware prepared for DG1-6300 Lg. Format IC cores, supplied with temporary keyed construction cores	\$83.00
DG2	Patented Degree DG2 Key System incorporating a locking sidebar	\$63.00/cyl.
DG260	Hardware prepared for DG2-6300 Lg. Format IC cores, supplied with temporary plastic construction cores	No addition
DG263	Patented Degree DG2 Large Format Interchangeable Core Cylinder - Includes master keying charges	\$146.00
DG264	Hardware prepared for DG2-6300 Lg. Format IC cores, supplied with temporary keyed construction cores	\$83.00
DG3	Patented Degree DG3 Key System incorporating a locking sidebar and UL437 listed	\$89.00/cyl.
DG360	Hardware prepared for DG3-6300 Lg. Format IC cores, supplied with temporary plastic construction cores	No addition
DG363	Patented Degree DG3 Large Format Interchangeable Core Cylinder - Includes master keying charges	\$172.00
DG364	Hardware prepared for DG3-6300 Lg. Format IC cores, supplied with temporary keyed construction cores	\$83.00
LC	Less Cylinder	-\$96.00/cyl.
OBS	Open Back Strike	\$79.00
RX	Request to Exit	\$206.00
SC▲†	Schlage "C" Keyway cylinder, (Number 41 Cylinder Only, 0 bitted)	No addition
SE▲†	Schlage "E" Keyway cylinder, (Number 41 Cylinder Only, 0 bitted)	No addition
SG	MicroShield® – an antimicrobial powder coat finish	\$73.00
WBS	Wrought Box Strike	No addition

NOTES: ▲ Options not available with a standard 50 function lockout cylinder. † Not available with 60, 63, 64 options.

CPC	7904 x WTBL x RH x 32D x CPC (Clear Powder Coat) All orders will continue to be handled as a "special" when CPC is ordered.	\$67.00
-----	--	---------

Experience a safer
and more open world

Copyright © 2002-2021 Sargent Manufacturing Company, an ASSA ABLOY Group company. All rights reserved.
Reproduction in whole or in part without the express written permission of Sargent Manufacturing Company is prohibited.
Contact us at: 800-727-5477 or visit www.sargentlock.com. In Canada contact us at: 800-461-3007 or visit www.assaabloydss.ca

USA & Canada Prices Effective May 1, 2021



WTBL Lever



WTBB Lever



WTBP Lever



WTBJ Lever

Escutcheon: WT (Shown) Levers: BL, BB, BP, BJ (Shown)

Function		Finish	
		10BE/26D/BSP/WSP	03/04/09/10/10B/10BL/14/15/20D/26/32/32D
Single Cyl			
7904	Storeroom or Closet		
7937	Classroom	\$838.00	\$862.00
7955	Office or Entry		
Single Cyl With Deadbolt			
7924	Room Door		
7925	Dormitory or Exit		
7943	Apartment Corridor	\$850.00	\$874.00
7945	Dormitory or Exit		
7950	Hotel Guest Lock	\$933.00	\$957.00
Double Cyl No Deadbolt			
7916	Apartment or Exit or Public Toilet	\$922.00	\$946.00
7938	Classroom Security Intruder		
Double Cyl With Deadbolt			
7926	Store Door	\$940.00	\$964.00
Electro Mechanical Single Cyl – Specify 12V or 24V			
7970-12V / 7970-24V	Fail Safe	\$1,149.00	\$1,173.00
7971-12V / 7971-24V	Fail Secure		
Electro Mechanical Double Cyl – Specify 12V or 24V			
7972-12V / 7972-24V	Fail Safe	\$1,235.00	\$1,259.00
7973-12V / 7973-24V	Fail Secure		
Non Keyed			
7915	Passage or Closet	\$649.00	\$673.00
7965	Privacy Bedroom or Bath (Latch)	\$753.00	\$777.00
7966	Privacy Bedroom or Bath (Deadbolt)	\$790.00	\$814.00
7993	Single Dummy Trim	\$265.00	\$277.00
7994	Double Dummy Trim	\$531.00	\$555.00
7995	Single Dummy Trim w/Lockbody	\$360.00	\$372.00

ML-130 MORTISE LOCKS

SARGENT®

ASSA ABLOY

OPTIONS

USA & Canada Prices Effective May 1, 2021

Options	Description	Price
1▲	7900 Line with 1-1/16" wide front for 1-3/8" doors.	\$62.00
10▲	SARGENT Signature Key System	\$63.00 / cyl.
11†▲	SARGENT XC Key System (not available with 10, 22, SC, SE options)	No addition
1160	SARGENT XC Large Format Interchangeable Plastic Disposable Construction Core	No addition
1163	SARGENT XC Large Format Interchangeable Core Cylinder - Includes masterkeying charges	\$83.00
1164	SARGENT XC Large Format Interchangeable Construction Core Cylinder	\$83.00
1170	Small Format interchangeable disposable construction core - to accept 7 Pin XC permanent core	No addition
11727P	Small Format interchangeable keyed construction core - to accept 7 Pin XC permanent core	\$75.00
11737P	Small Format interchangeable core - to accept 7 pin XC permanent core	\$75.00 / cyl.
21▲†	SARGENT Construction Key System (lost ball) Standard on all new systems established since 5/1/96	\$16.00 / cyl.
22▲†	SARGENT Construction Key System (split key) To be used on pre-established split key systems only	\$32.00 / cyl.
31	Thick Doors - Extended Lip Required - Specify Length C to E	
	- Cylinders - IMPORTANT- See catalog 7800/8200 option page for cylinder limitations	
	- Below charges DO NOT include additional charges for special cylinder requirements	
	Doors up to 2-1/2" thick - lock centered	No addition
	Doors 2-5/8" to 6" thick OR doors 1-3/4" thick w/max 1" paneling one side.	
	For example: Specify 1-3/4" door with panel (Side) on inside or outside	Non Keyed function \$50.00 Keyed function \$100.00
60	SARGENT Large Format Interchangeable Plastic Disposable Construction Core	No addition
63	SARGENT Large Format Interchangeable core cylinder, includes master keying charges	\$83.00 / cyl.
64	SARGENT Large Format Interchangeable Construction Core Cylinder	\$83.00
6573▲†	Small Format 6-Pin Uncombined Core (Refer to CK-12)	\$65.00 / cyl.
65737P▲†	Small Format 7-Pin Uncombined Core (Refer to CK-12)	\$65.00 / cyl.
70▲†	Small Format Interchangeable disposable plastic construction core	No addition
72▲†	Small Format Interchangeable 6-pin construction core (7-pin with 11 options)	\$75.00
73▲†	Small Format interchangeable core 6-pin Includes MK and GMK keying charges	\$75.00 / cyl.
737P▲†	Small Format interchangeable core 7-pin (refer to CK-12 for available keyways) Includes MK and GMK keying charges	\$75.00 / cyl.
74	Lock case wrapped in lead - handing required (roses not available)	\$294.00
F182▲†	SARGENT Keso Security Cylinder – patented – new key systems	\$91.00 / cyl.
F183▲†	SARGENT Keso Security Removable Core Cylinder – patented – new key systems	\$130.00 / cyl.
81▲†	Cylinder to accept Keso (83) and Keso F1(F183) Removable Core – no core provided	No addition
82▲†	SARGENT Keso Security Cylinder (For existing systems only)	\$91.00 / cyl.
83▲†	SARGENT Keso Security Removable Core Cylinder (For existing systems only)	\$130.00 / cyl.
84▲†	SARGENT Keso Security Removable Construction Core Cylinder	See CK-18
85	Tactile Warning - Abrasive coating on inside lever	\$49.00
86	Tactile Warning - Abrasive coating on outside lever	\$49.00
87	Tactile Warning - Abrasive coating on both levers	\$98.00
BR	SARGENT Bump Resistant Cylinders (N/A w/10, 22, 30, 60, 63, 64, 70, 72, 73, 737P, KESO, SC, & SE options)	\$25.00 / cyl.
DG1	Patented Degree DG1 Key System	No addition
DG160	Hardware prepared for DG1-6300 Lg. Format IC cores, supplied with temporary plastic construction cores	No addition
DG163	Patented Degree DG1 Large Format Interchangeable Core Cylinder - Includes master keying charges	\$83.00
DG164	Hardware prepared for DG1-6300 Lg. Format IC cores, supplied with temporary keyed construction cores	\$83.00
DG2	Patented Degree DG2 Key System incorporating a locking sidebar	\$63.00/cyl.
DG260	Hardware prepared for DG2-6300 Lg. Format IC cores, supplied with temporary plastic construction cores	No addition
DG263	Patented Degree DG2 Large Format Interchangeable Core Cylinder - Includes master keying charges	\$146.00
DG264	Hardware prepared for DG2-6300 Lg. Format IC cores, supplied with temporary keyed construction cores	\$83.00
DG3	Patented Degree DG3 Key System incorporating a locking sidebar and UL437 listed	\$89.00/cyl.
DG360	Hardware prepared for DG3-6300 Lg. Format IC cores, supplied with temporary plastic construction cores	No addition
DG363	Patented Degree DG3 Large Format Interchangeable Core Cylinder - Includes master keying charges	\$172.00
DG364	Hardware prepared for DG3-6300 Lg. Format IC cores, supplied with temporary keyed construction cores	\$83.00
LB	Extra large thumbturn	\$18.00
LC	Less Cylinder	-\$96.00/cyl.
OBS	Open Back Strike	\$79.00
RX	Request to Exit	\$206.00
SC▲†	Schlage "C" Keyway cylinder, (Number 41 Cylinder Only, 0 bitted)	No addition
SE▲†	Schlage "E" Keyway cylinder, (Number 41 Cylinder Only, 0 bitted)	No addition
SG	MicroShield® – an antimicrobial powder coat finish	\$73.00
T1	Decorative thumbturn; backplate matches rose design chosen	No Addition
T2	Decorative square thumbturn; backplate matches rose design chosen	No Addition
T3	Decorative cylinder thumbturn; backplate matches rose design chosen	No Addition
WBS	Wrought Box Strike	No addition

NOTES: ▲ Options not available with a standard 50 function lockout cylinder. † Not available with 60, 63, 64 options.

CPC	7904 x OH001 x RH x 32D x CPC (Clear Powder Coat) All orders will continue to be handled as a "special" when CPC is ordered.	\$67.00
-----	---	---------

Experience a safer
and more open world

Copyright © 2002-2021 Sargent Manufacturing Company, an ASSA ABLOY Group company. All rights reserved.
Reproduction in whole or in part without the express written permission of Sargent Manufacturing Company is prohibited.
Contact us at: 800-727-5477 or visit www.sargentlock.com. In Canada contact us at: 800-461-3007 or visit www.assaabloydss.ca

Rose Design:

CO (2-3/4")
CR (2-3/16")
LN (2")
O (2-3/4")
TO (2-3/4")
TR (2-3/16")
E2 (2-11/16")
E3 (2-1/16")
E4 (3-1/4")

Lever Designs:

H001, H002



H001



H002

How to order:

60-7904 x COH001 x RH x 26D
Option 60
Function 7904
Rose CO
Lever H001
Hand RH
Finish 26D

Function		Finish	
		10BE/26D/BSP/WSP	03/04/09/10/10B/10BL/14/15/20D/26/32/32D
Single Cyl			
7904	Storeroom or Closet		
7937	Classroom	\$854.00	\$878.00
7955	Office or Entry		
Single Cyl With Deadbolt			
7924	Room Door		
7925	Dormitory or Exit		
7943	Apartment Corridor	\$878.00	\$902.00
7945	Dormitory or Exit		
7950	Hotel Guest Lock	\$944.00	\$968.00
Double Cyl No Deadbolt			
7916	Apartment or Exit or Public Toilet	\$941.00	\$965.00
7938	Classroom Security Intruder		
Double Cyl With Deadbolt			
7926	Store Door	\$958.00	\$982.00
Electro Mechanical Single Cyl – Specify 12V or 24V			
7970-12V / 7970-24V	Fail Safe	\$1,170.00	\$1,194.00
7971-12V / 7971-24V	Fail Secure		
Electro Mechanical Double Cyl – Specify 12V or 24V			
7972-12V / 7972-24V	Fail Safe	\$1,256.00	\$1,280.00
7973-12V / 7973-24V	Fail Secure		
Non Keyed			
7915	Passage or Closet	\$678.00	\$702.00
7965	Privacy Bedroom or Bath (Latch)	\$777.00	\$801.00
7966	Privacy Bedroom or Bath (Deadbolt)	\$815.00	\$839.00
7993	Single Dummy Trim	\$269.00	\$293.00
7994	Double Dummy Trim	\$560.00	\$584.00
7995	Single Dummy Trim w/Lockbody	\$360.00	\$384.00

ML-132 MORTISE LOCKS

SARGENT®

ASSA ABLOY

OPTIONS

USA & Canada Prices Effective May 1, 2021

Options	Description	Price
1▲	7900 Line with 1-1/16" wide front for 1-3/8" doors.	\$62.00
10▲	SARGENT Signature Key System	\$63.00 / cyl.
11†▲	SARGENT XC Key System (not available with 10, 22, SC, SE options)	No addition
1160	SARGENT XC Large Format Interchangeable Plastic Disposable Construction Core	No addition
1163	SARGENT XC Large Format Interchangeable Core Cylinder - Includes masterkeying charges	\$83.00
1164	SARGENT XC Large Format Interchangeable Construction Core Cylinder	\$83.00
1170	Small Format interchangeable disposable construction core - to accept 7 Pin XC permanent core	No addition
11727P	Small Format interchangeable keyed construction core - to accept 7 Pin XC permanent core	\$75.00
11737P	Small Format interchangeable core - to accept 7 pin XC permanent core	\$75.00 / cyl.
21▲†	SARGENT Construction Key System (lost ball) Standard on all new systems established since 5/1/96	\$16.00 / cyl.
22▲†	SARGENT Construction Key System (split key) To be used on pre-established split key systems only	\$32.00 / cyl.
31	Thick Doors - Extended Lip Required - Specify Length C to E	
	- Cylinders - IMPORTANT- See catalog 7800/8200 option page for cylinder limitations	
	- Below charges DO NOT include additional charges for special cylinder requirements	
	Doors up to 2-1/2" thick - lock centered	No addition
	Doors 2-5/8" to 6" thick OR doors 1-3/4" thick w/max 1" paneling one side.	
	For example: Specify 1-3/4" door with panel (Side) on inside or outside	Non Keyed function \$50.00 Keyed function \$100.00
60	SARGENT Large Format Interchangeable Plastic Disposable Construction Core	No addition
63	SARGENT Large Format Interchangeable core cylinder, includes master keying charges	\$83.00 / cyl.
64	SARGENT Large Format Interchangeable Construction Core Cylinder	\$83.00
6573▲†	Small Format 6-Pin Uncombined Core (Refer to CK-12)	\$65.00 / cyl.
65737P▲†	Small Format 7-Pin Uncombined Core (Refer to CK-12)	\$65.00 / cyl.
70▲†	Small Format Interchangeable disposable plastic construction core	No addition
72▲†	Small Format Interchangeable 6-pin construction core (7-pin with 11 options)	\$75.00
73▲†	Small Format interchangeable core 6-pin Includes MK and GMK keying charges	\$75.00 / cyl.
737P▲†	Small Format interchangeable core 7-pin (refer to CK-12 for available keyways) Includes MK and GMK keying charges	\$75.00 / cyl.
74	Lock case wrapped in lead - handing required (roses not available)	\$294.00
F182▲†	SARGENT Keso Security Cylinder – patented – new key systems	\$91.00 / cyl.
F183▲†	SARGENT Keso Security Removable Core Cylinder – patented – new key systems	\$130.00 / cyl.
81▲†	Cylinder to accept Keso (83) and Keso F1(F183) Removable Core – no core provided	No addition
82▲†	SARGENT Keso Security Cylinder (For existing systems only)	\$91.00 / cyl.
83▲†	SARGENT Keso Security Removable Core Cylinder (For existing systems only)	\$130.00 / cyl.
84▲†	SARGENT Keso Security Removable Construction Core Cylinder	See CK-18
85	Tactile Warning - Abrasive coating on inside lever	\$49.00
86	Tactile Warning - Abrasive coating on outside lever	\$49.00
87	Tactile Warning - Abrasive coating on both levers	\$98.00
BR	SARGENT Bump Resistant Cylinders (N/A w/10, 22, 30, 60, 63, 64, 70, 72, 73, 737P, KESO, SC, & SE options)	\$25.00 /cyl.
DG1	Patented Degree DG1 Key System	No addition
DG160	Hardware prepared for DG1-6300 Lg. Format IC cores, supplied with temporary plastic construction cores	No addition
DG163	Patented Degree DG1 Large Format Interchangeable Core Cylinder - Includes master keying charges	\$83.00
DG164	Hardware prepared for DG1-6300 Lg. Format IC cores, supplied with temporary keyed construction cores	\$83.00
DG2	Patented Degree DG2 Key System incorporating a locking sidebar	\$63.00/cyl.
DG260	Hardware prepared for DG2-6300 Lg. Format IC cores, supplied with temporary plastic construction cores	No addition
DG263	Patented Degree DG2 Large Format Interchangeable Core Cylinder - Includes master keying charges	\$146.00
DG264	Hardware prepared for DG2-6300 Lg. Format IC cores, supplied with temporary keyed construction cores	\$83.00
DG3	Patented Degree DG3 Key System incorporating a locking sidebar and UL437 listed	\$89.00/cyl.
DG360	Hardware prepared for DG3-6300 Lg. Format IC cores, supplied with temporary plastic construction cores	No addition
DG363	Patented Degree DG3 Large Format Interchangeable Core Cylinder - Includes master keying charges	\$172.00
DG364	Hardware prepared for DG3-6300 Lg. Format IC cores, supplied with temporary keyed construction cores	\$83.00
LB	Extra large thumbturn	\$18.00
LC	Less Cylinder	-\$96.00/cyl.
OBS	Open Back Strike	\$79.00
RX	Request to Exit	\$206.00
SC▲†	Schlage "C" Keyway cylinder, (Number 41 Cylinder Only, 0 bitted)	No addition
SE▲†	Schlage "E" Keyway cylinder, (Number 41 Cylinder Only, 0 bitted)	No addition
SG	MicroShield® – an antimicrobial powder coat finish	\$73.00
T1	Decorative thumbturn; backplate matches rose design chosen	No Addition
T2	Decorative square thumbturn; backplate matches rose design chosen	No Addition
T3	Decorative cylinder thumbturn; backplate matches rose design chosen	No Addition
WBS	Wrought Box Strike	No addition

NOTES: ▲ Options not available with a standard 50 function lockout cylinder. † Not available with 60, 63, 64 options.

CPC	7904 x OH004 x RH x 32D x CPC (Clear Powder Coat) All orders will continue to be handled as a "special" when CPC is ordered.	\$67.00
-----	---	---------

Experience a safer
and more open world

Copyright © 2002-2021 Sargent Manufacturing Company, an ASSA ABLOY Group company. All rights reserved.
Reproduction in whole or in part without the express written permission of Sargent Manufacturing Company is prohibited.
Contact us at: 800-727-5477 or visit www.sargentlock.com. In Canada contact us at: 800-461-3007 or visit www.assaabloydss.ca

USA & Canada Prices Effective May 1, 2021

Rose Design:

CO (2-3/4")
CR (2-3/16")
LN (2")
O (2-3/4")
TO (2-3/4")
TR (2-3/16")
E2 (2-11/16")
E3 (2-1/16")
E4 (3-1/4")

Lever Designs:

H003, H004, H005, H006, H007, *H008, H009,
H010, H011



H004



H005

How to order:

60-7904 x COH003 x RH x 10BE
Option 60
Function 7904
Rose CO
Lever H004
Hand RH
Finish 10BE

* Handed - specify hand when ordering.

Function		Finish	
		10BE/26D/BSP/WSP	03/04/09/10/10B/10BL/14/15/20D/26/32/32D
Single Cyl			
7904	Storeroom or Closet		
7937	Classroom	\$919.00	\$943.00
7955	Office or Entry		
Single Cyl With Deadbolt			
7924	Room Door		
7925	Dormitory or Exit		
7943	Apartment Corridor	\$941.00	\$965.00
7945	Dormitory or Exit		
7950	Hotel Guest Lock	\$1,007.00	\$1,031.00
Double Cyl No Deadbolt			
7916	Apartment or Exit or Public Toilet	\$1,002.00	\$1,026.00
7938	Classroom Security Intruder		
Double Cyl With Deadbolt			
7926	Store Door	\$1,015.00	\$1,039.00
Electro Mechanical Single Cyl – Specify 12V or 24V			
7970-12V / 7970-24V	Fail Safe	\$1,216.00	\$1,240.00
7971-12V / 7971-24V	Fail Secure		
Electro Mechanical Double Cyl – Specify 12V or 24V			
7972-12V / 7972-24V	Fail Safe	\$1,294.00	\$1,318.00
7973-12V / 7973-24V	Fail Secure		
Non Keyed			
7915	Passage or Closet	\$753.00	\$777.00
7965	Privacy Bedroom or Bath (Latch)	\$850.00	\$874.00
7966	Privacy Bedroom or Bath (Deadbolt)	\$883.00	\$907.00
7993	Single Dummy Trim	\$379.00	\$403.00
7994	Double Dummy Trim	\$647.00	\$671.00
7995	Single Dummy Trim w/Lockbody	\$465.00	\$489.00

ML-134 MORTISE LOCKS

SARGENT®

ASSA ABLOY

OPTIONS

USA & Canada Prices Effective May 1, 2021

Options	Description	Price
1▲	7900 Line with 1-1/16" wide front for 1-3/8" doors.	\$62.00
10▲	SARGENT Signature Key System	\$63.00 / cyl.
11†▲	SARGENT XC Key System (not available with 10, 22, SC, SE options)	No addition
1160	SARGENT XC Large Format Interchangeable Plastic Disposable Construction Core	No addition
1163	SARGENT XC Large Format Interchangeable Core Cylinder - Includes masterkeying charges	\$83.00
1164	SARGENT XC Large Format Interchangeable Construction Core Cylinder	\$83.00
1170	Small Format interchangeable disposable construction core - to accept 7 Pin XC permanent core	No addition
11727P	Small Format interchangeable keyed construction core - to accept 7 Pin XC permanent core	\$75.00
11737P	Small Format interchangeable core - to accept 7 pin XC permanent core	\$75.00 / cyl.
21▲†	SARGENT Construction Key System (lost ball) Standard on all new systems established since 5/1/96	\$16.00 / cyl.
22▲†	SARGENT Construction Key System (split key) To be used on pre-established split key systems only	\$32.00 / cyl.
31	Thick Doors - Extended Lip Required - Specify Length C to E - Cylinders - IMPORTANT- See catalog 7800/8200 option page for cylinder limitations - Below charges DO NOT include additional charges for special cylinder requirements	No addition
	Doors up to 2-1/2" thick - lock centered	No addition
	Doors 2-5/8" to 6" thick OR doors 1-3/4" thick w/max 1" paneling one side. For example: Specify 1-3/4" door with panel (Side) on inside or outside	Non Keyed function \$50.00 Keyed function \$100.00
60	SARGENT Large Format Interchangeable Plastic Disposable Construction Core	No addition
63	SARGENT Large Format Interchangeable core cylinder, includes master keying charges	\$83.00 / cyl.
64	SARGENT Large Format Interchangeable Construction Core Cylinder	\$83.00
6573▲†	Small Format 6-Pin Uncombined Core (Refer to CK-12)	\$65.00 / cyl.
65737P▲†	Small Format 7-Pin Uncombined Core (Refer to CK-12)	\$65.00 / cyl.
70▲†	Small Format Interchangeable disposable plastic construction core	No addition
72▲†	Small Format Interchangeable 6-pin construction core (7-pin with 11 options)	\$75.00
73▲†	Small Format interchangeable core 6-pin Includes MK and GMK keying charges	\$75.00 / cyl.
737P▲†	Small Format interchangeable core 7-pin (refer to CK-12 for available keyways) Includes MK and GMK keying charges	\$75.00 / cyl.
74	Lock case wrapped in lead - handing required (roses not available)	\$294.00
F182▲†	SARGENT Keso Security Cylinder – patented – new key systems	\$91.00 / cyl.
F183▲†	SARGENT Keso Security Removable Core Cylinder – patented – new key systems	\$130.00 / cyl.
81▲†	Cylinder to accept Keso (83) and Keso F1(F183) Removable Core – no core provided	No addition
82▲†	SARGENT Keso Security Cylinder (For existing systems only)	\$91.00 / cyl.
83▲†	SARGENT Keso Security Removable Core Cylinder (For existing systems only)	\$130.00 / cyl.
84▲†	SARGENT Keso Security Removable Construction Core Cylinder	See CK-18
85	Tactile Warning - Abrasive coating on inside lever	\$49.00
86	Tactile Warning - Abrasive coating on outside lever	\$49.00
87	Tactile Warning - Abrasive coating on both levers	\$98.00
BR	SARGENT Bump Resistant Cylinders (N/A w/10, 22, 30, 60, 63, 64, 70, 72, 73, 737P, KESO, SC, & SE options)	\$25.00 /cyl.
DG1	Patented Degree DG1 Key System	No addition
DG160	Hardware prepared for DG1-6300 Lg. Format IC cores, supplied with temporary plastic construction cores	No addition
DG163	Patented Degree DG1 Large Format Interchangeable Core Cylinder - Includes master keying charges	\$83.00
DG164	Hardware prepared for DG1-6300 Lg. Format IC cores, supplied with temporary keyed construction cores	\$83.00
DG2	Patented Degree DG2 Key System incorporating a locking sidebar	\$63.00/cyl.
DG260	Hardware prepared for DG2-6300 Lg. Format IC cores, supplied with temporary plastic construction cores	No addition
DG263	Patented Degree DG2 Large Format Interchangeable Core Cylinder - Includes master keying charges	\$146.00
DG264	Hardware prepared for DG2-6300 Lg. Format IC cores, supplied with temporary keyed construction cores	\$83.00
DG3	Patented Degree DG3 Key System incorporating a locking sidebar and UL437 listed	\$89.00/cyl.
DG360	Hardware prepared for DG3-6300 Lg. Format IC cores, supplied with temporary plastic construction cores	No addition
DG363	Patented Degree DG3 Large Format Interchangeable Core Cylinder - Includes master keying charges	\$172.00
DG364	Hardware prepared for DG3-6300 Lg. Format IC cores, supplied with temporary keyed construction cores	\$83.00
LB	Extra large thumbturn	\$18.00
LC	Less Cylinder	-\$96.00/cyl.
OBS	Open Back Strike	\$79.00
RX	Request to Exit	\$206.00
SC▲†	Schlage "C" Keyway cylinder, (Number 41 Cylinder Only, 0 bitted)	No addition
SE▲†	Schlage "E" Keyway cylinder, (Number 41 Cylinder Only, 0 bitted)	No addition
SG	MicroShield® – an antimicrobial powder coat finish	\$73.00
T1	Decorative thumbturn; backplate matches rose design chosen	No Addition
T2	Decorative square thumbturn; backplate matches rose design chosen	No Addition
T3	Decorative cylinder thumbturn; backplate matches rose design chosen	No Addition
WBS	Wrought Box Strike	No addition

NOTES: ▲ Options not available with a standard 50 function lockout cylinder. † Not available with 60, 63, 64 options.

CPC	7904 x OMC x RH x 32D x CPC (Clear Powder Coat) All orders will continue to be handled as a "special" when CPC is ordered.	\$67.00
-----	---	---------

Experience a safer
and more open world

Copyright © 2002-2021 Sargent Manufacturing Company, an ASSA ABLOY Group company. All rights reserved.
Reproduction in whole or in part without the express written permission of Sargent Manufacturing Company is prohibited.
Contact us at: 800-727-5477 or visit www.sargentlock.com. In Canada contact us at: 800-461-3007 or visit www.assaabloydss.ca

Rose Design:

CO (2-3/4")
CR (2-3/16")
LN (2")
O (2-3/4")
TO (2-3/4")
TR (2-3/16")
E2 (2-11/16")
E3 (2-1/16")
E4 (3-1/4")

All Studio Collection Levers

(except Gramercy, Wooster Square, & Grant Park)

How to order:

60-7904 x CRMM x RH x 26D
Option 60
Function 7904
Rose CR
Lever MM
Hand RH
Finish 26D

Function		Finish	
Single Cyl		10BE/26D/BSP/WSP	03/04/09/10/10B/10BL/14/15/20D/26/32/32D
7904	Storeroom or Closet		
7937	Classroom	\$813.00	\$837.00
7955	Office or Entry		
Single Cyl With Deadbolt			
7924	Room Door		
7925	Dormitory or Exit		
7943	Apartment Corridor	\$833.00	\$857.00
7945	Dormitory or Exit		
7950	Hotel Guest Lock	\$899.00	\$923.00
Double Cyl No Deadbolt			
7916	Apartment or Exit or Public Toilet	\$896.00	\$920.00
7938	Classroom Security Intruder		
Double Cyl With Deadbolt			
7926	Store Door	\$914.00	\$938.00
Electro Mechanical Single Cyl – Specify 12V or 24V			
7970-12V / 7970-24V	Fail Safe	\$1,126.00	\$1,150.00
7971-12V / 7971-24V	Fail Secure		
Electro Mechanical Double Cyl – Specify 12V or 24V			
7972-12V / 7972-24V	Fail Safe	\$1,207.00	\$1,231.00
7973-12V / 7973-24V	Fail Secure		
Non Keyed			
7915	Passage or Closet	\$630.00	\$654.00
7965	Privacy Bedroom or Bath (Latch)	\$733.00	\$757.00
7966	Privacy Bedroom or Bath (Deadbolt)	\$774.00	\$798.00
7993	Single Dummy Trim	\$260.00	\$272.00
7994	Double Dummy Trim	\$523.00	\$547.00
7995	Single Dummy Trim w/Lockbody	\$354.00	\$366.00

ML-136 MORTISE LOCKS

SARGENT®

ASSA ABLOY

OPTIONS

USA & Canada Prices Effective May 1, 2021

Options	Description	Price
1▲	7900 Line with 1-1/16" wide front for 1-3/8" doors.	\$62.00
10▲	SARGENT Signature Key System	\$63.00 / cyl.
11†▲	SARGENT XC Key System (not available with 10, 22, SC, SE options)	No addition
1160	SARGENT XC Large Format Interchangeable Plastic Disposable Construction Core	No addition
1163	SARGENT XC Large Format Interchangeable Core Cylinder - Includes masterkeying charges	\$83.00
1164	SARGENT XC Large Format Interchangeable Construction Core Cylinder	\$83.00
1170	Small Format interchangeable disposable construction core - to accept 7 Pin XC permanent core	No addition
11727P	Small Format interchangeable keyed construction core - to accept 7 Pin XC permanent core	\$75.00
11737P	Small Format interchangeable core - to accept 7 pin XC permanent core	\$75.00 / cyl.
21▲†	SARGENT Construction Key System (lost ball) Standard on all new systems established since 5/1/96	\$16.00 / cyl.
22▲†	SARGENT Construction Key System (split key) To be used on pre-established split key systems only	\$32.00 / cyl.
31	Thick Doors - Extended Lip Required - Specify Length C to E - Cylinders - IMPORTANT- See catalog 7800/8200 option page for cylinder limitations - Below charges DO NOT include additional charges for special cylinder requirements	
	Doors up to 2-1/2" thick - lock centered	No addition
	Doors 2-5/8" to 6" thick OR doors 1-3/4" thick w/max 1" paneling one side. For example: Specify 1-3/4" door with panel (Side) on inside or outside	
		Non Keyed function \$50.00 Keyed function \$100.00
60	SARGENT Large Format Interchangeable Plastic Disposable Construction Core	No addition
63	SARGENT Large Format Interchangeable core cylinder, includes master keying charges	\$83.00 / cyl.
64	SARGENT Large Format Interchangeable Construction Core Cylinder	\$83.00
6573▲†	Small Format 6-Pin Uncombined Core (Refer to CK-12)	\$65.00 / cyl.
65737P▲†	Small Format 7-Pin Uncombined Core (Refer to CK-12)	\$65.00 / cyl.
70▲†	Small Format Interchangeable disposable plastic construction core	No addition
72▲†	Small Format Interchangeable 6-pin construction core (7-pin with 11 option)	\$75.00
73▲†	Small Format interchangeable core 6-pin Includes MK and GMK keying charges	\$75.00 / cyl.
737P▲†	Small Format interchangeable core 7-pin (refer to CK-12 for available keyways) Includes MK and GMK keying charges	\$75.00 / cyl.
F182▲†	SARGENT Keso Security Cylinder – patented – new key systems	\$91.00 / cyl.
F183▲†	SARGENT Keso Security Removable Core Cylinder – patented – new key systems	\$130.00 / cyl.
81▲†	Cylinder to accept Keso (83) and Keso F1(F183) Removable Core – no core provided	No addition
82▲†	SARGENT Keso Security Cylinder (For existing systems only)	\$91.00 / cyl.
83▲†	SARGENT Keso Security Removable Core Cylinder (For existing systems only)	\$130.00 / cyl.
84▲†	SARGENT Keso Security Removable Construction Core Cylinder	See CK-18
85	Tactile Warning - Abrasive coating on inside lever	\$49.00
86	Tactile Warning - Abrasive coating on outside lever	\$49.00
87	Tactile Warning - Abrasive coating on both levers	\$98.00
BR	SARGENT Bump Resistant Cyls. (N/A w/10, 22, 30, 60, 63, 64, 70,72, 73, 737P, KESO, SC, SE)	\$25.00 /cyl.
DG1	Patented Degree DG1 Key System	No addition
DG160	Hardware prepared for DG1-6300 Lg. Format IC cores, supplied with temporary plastic construction cores	No addition
DG163	Patented Degree DG1 Large Format Interchangeable Core Cylinder - Includes master keying charges	\$83.00
DG164	Hardware prepared for DG1-6300 Lg. Format IC cores, supplied with temporary keyed construction cores	\$83.00
DG2	Patented Degree DG2 Key System incorporating a locking sidebar	\$63.00/cyl.
DG260	Hardware prepared for DG2-6300 Lg. Format IC cores, supplied with temporary plastic construction cores	No addition
DG263	Patented Degree DG2 Large Format Interchangeable Core Cylinder - Includes master keying charges	\$146.00
DG264	Hardware prepared for DG2-6300 Lg. Format IC cores, supplied with temporary keyed construction cores	\$83.00
DG3	Patented Degree DG3 Key System incorporating a locking sidebar and UL437 listed	\$89.00/cyl.
DG360	Hardware prepared for DG3-6300 Lg. Format IC cores, supplied with temporary plastic construction cores	No addition
DG363	Patented Degree DG3 Large Format Interchangeable Core Cylinder - Includes master keying charges	\$172.00
DG364	Hardware prepared for DG3-6300 Lg. Format IC cores, supplied with temporary keyed construction cores	\$83.00
LC	Less Cylinder	-\$96.00/cyl.
OBS	Open Back Strike	\$79.00
RX	Request to Exit	\$206.00
SC▲†	Schlage "C" Keyway cylinder, (Number 41 Cylinder Only, 0 bitted)	No addition
SE▲†	Schlage "E" Keyway cylinder, (Number 41 Cylinder Only, 0 bitted)	No addition
SG	MicroShield® – an antimicrobial powder coat finish	\$73.00
WBS	Wrought Box Strike	No addition

NOTES: ▲ Options not available with a standard 50 function lockout cylinder. † Not available with 60, 63, 64 options.

CPC	7904 x CEH001 x RH x 32D x CPC (Clear Powder Coat) All orders will continue to be handled as a "special" when CPC is ordered.	\$67.00
-----	--	---------

Experience a safer
and more open world

Copyright © 2002-2021 Sargent Manufacturing Company, an ASSA ABLOY Group company. All rights reserved.
Reproduction in whole or in part without the express written permission of Sargent Manufacturing Company is prohibited.
Contact us at: 800-727-5477 or visit www.sargentlock.com. In Canada contact us at: 800-461-3007 or visit www.assaabloydss.ca

7900 STUDIO COLLECTION WOOSTER SQUARE

USA & Canada Prices Effective May 1, 2021

Escutcheon Design:

CE
TE
LE1

Lever Designs:

H001, H002



H001



H002

How to order:

60-7904 x CEH001 x RH x 26D
Option 60
Function 7904
Escutcheon CO
Lever H001
Hand RH
Finish 26D

Function		Finish	
		10BE/26D/BSP/WSP	03/04/09/10/10B/10BL/14/15/20D/26/32/32D
Single Cyl			
7904	Storeroom or Closet		
7937	Classroom	\$903.00	\$927.00
7955	Office or Entry		
Single Cyl With Deadbolt			
7924	Room Door		
7925	Dormitory or Exit		
7943	Apartment Corridor	\$920.00	\$944.00
7945	Dormitory or Exit		
7950	Hotel Guest Lock	\$1,002.00	\$1,026.00
Double Cyl No Deadbolt			
7916	Apartment or Exit or Public Toilet	\$990.00	\$1,014.00
7938	Classroom Security Intruder		
Double Cyl With Deadbolt			
7926	Store Door	\$1,009.00	\$1,033.00
Electro Mechanical Single Cyl – Specify 12V or 24V			
7970-12V / 7970-24V	Fail Safe	\$1,221.00	\$1,245.00
7971-12V / 7971-24V	Fail Secure		
Electro Mechanical Double Cyl – Specify 12V or 24V			
7972-12V / 7972-24V	Fail Safe	\$1,303.00	\$1,327.00
7973-12V / 7973-24V	Fail Secure		
Non Keyed			
7915	Passage or Closet	\$712.00	\$736.00
7965	Privacy Bedroom or Bath (Latch)	\$818.00	\$842.00
7966	Privacy Bedroom or Bath (Deadbolt)	\$855.00	\$879.00
7993	Single Dummy Trim	\$287.00	\$311.00
7994	Double Dummy Trim	\$593.00	\$617.00
7995	Single Dummy Trim w/Lockbody	\$376.00	\$400.00

ML-138 MORTISE LOCKS

SARGENT®

ASSA ABLOY

OPTIONS

USA & Canada Prices Effective May 1, 2021

Options	Description	Price
1▲	7900 Line with 1-1/16" wide front for 1-3/8" doors.	\$62.00
10▲	SARGENT Signature Key System	\$63.00 / cyl.
11†▲	SARGENT XC Key System (not available with 10, 22, SC, SE options)	No addition
1160	SARGENT XC Large Format Interchangeable Plastic Disposable Construction Core	No addition
1163	SARGENT XC Large Format Interchangeable Core Cylinder - Includes masterkeying charges	\$83.00
1164	SARGENT XC Large Format Interchangeable Construction Core Cylinder	\$83.00
1170	Small Format interchangeable disposable construction core - to accept 7 Pin XC permanent core	No addition
11727P	Small Format interchangeable keyed construction core - to accept 7 Pin XC permanent core	\$75.00
11737P	Small Format interchangeable core - to accept 7 pin XC permanent core	\$75.00 / cyl.
21▲†	SARGENT Construction Key System (lost ball) Standard on all new systems established since 5/1/96	\$16.00 / cyl.
22▲†	SARGENT Construction Key System (split key) To be used on pre-established split key systems only	\$32.00 / cyl.
31	Thick Doors - Extended Lip Required - Specify Length C to E - Cylinders - IMPORTANT- See catalog 7800/8200 option page for cylinder limitations - Below charges DO NOT include additional charges for special cylinder requirements	
	Doors up to 2-1/2" thick - lock centered	No addition
	Doors 2-5/8" to 6" thick OR doors 1-3/4" thick w/max 1" paneling one side. For example: Specify 1-3/4" door with panel (Side) on inside or outside	Non Keyed function \$50.00 Keyed function \$100.00
60	SARGENT Large Format Interchangeable Plastic Disposable Construction Core	No addition
63	SARGENT Large Format Interchangeable core cylinder, includes master keying charges	\$83.00 / cyl.
64	SARGENT Large Format Interchangeable Construction Core Cylinder	\$83.00
6573▲†	Small Format 6-Pin Uncombined Core (Refer to CK-12)	\$65.00 / cyl.
65737P▲†	Small Format 7-Pin Uncombined Core (Refer to CK-12)	\$65.00 / cyl.
70▲†	Small Format Interchangeable disposable plastic construction core	No addition
72▲†	Small Format Interchangeable 6-pin construction core (7-pin with 11 option)	\$75.00
73▲†	Small Format interchangeable core 6-pin Includes MK and GMK keying charges	\$75.00 / cyl
737P▲†	Small Format interchangeable core 7-pin (refer to CK-12 for available keyways) Includes MK and GMK keying charges	\$75.00 / cyl
F182▲†	SARGENT Keso Security Cylinder – patented – new key systems	\$91.00 / cyl.
F183▲†	SARGENT Keso Security Removable Core Cylinder – patented – new key systems	\$130.00 / cyl.
81▲†	Cylinder to accept Keso (83) and Keso F1(F183) Removable Core – no core provided	No addition
82▲†	SARGENT Keso Security Cylinder (For existing systems only)	\$91.00 / cyl.
83▲†	SARGENT Keso Security Removable Core Cylinder (For existing systems only)	\$130.00 / cyl.
84▲†	SARGENT Keso Security Removable Construction Core Cylinder	See CK-18
85	Tactile Warning - Abrasive coating on inside lever	\$49.00
86	Tactile Warning - Abrasive coating on outside lever	\$49.00
87	Tactile Warning - Abrasive coating on both levers	\$98.00
BR	SARGENT Bump Resistant Cyls. (N/A w/10, 22, 30, 60, 63, 64, 70,72, 73, 737P, KESO, SC, SE)	\$25.00 /cyl.
DG1	Patented Degree DG1 Key System	No addition
DG160	Hardware prepared for DG1-6300 Lg. Format IC cores, supplied with temporary plastic construction cores	No addition
DG163	Patented Degree DG1 Large Format Interchangeable Core Cylinder - Includes master keying charges	\$83.00
DG164	Hardware prepared for DG1-6300 Lg. Format IC cores, supplied with temporary keyed construction cores	\$83.00
DG2	Patented Degree DG2 Key System incorporating a locking sidebar	\$63.00/cyl.
DG260	Hardware prepared for DG2-6300 Lg. Format IC cores, supplied with temporary plastic construction cores	No addition
DG263	Patented Degree DG2 Large Format Interchangeable Core Cylinder - Includes master keying charges	\$146.00
DG264	Hardware prepared for DG2-6300 Lg. Format IC cores, supplied with temporary keyed construction cores	\$83.00
DG3	Patented Degree DG3 Key System incorporating a locking sidebar and UL437 listed	\$89.00/cyl.
DG360	Hardware prepared for DG3-6300 Lg. Format IC cores, supplied with temporary plastic construction cores	No addition
DG363	Patented Degree DG3 Large Format Interchangeable Core Cylinder - Includes master keying charges	\$172.00
DG364	Hardware prepared for DG3-6300 Lg. Format IC cores, supplied with temporary keyed construction cores	\$83.00
LC	Less Cylinder	-\$96.00/cyl.
OBS	Open Back Strike	\$79.00
RX	Request to Exit	\$206.00
SC▲†	Schlage "C" Keyway cylinder, (Number 41 Cylinder Only, 0 bitted)	No addition
SE▲†	Schlage "E" Keyway cylinder, (Number 41 Cylinder Only, 0 bitted)	No addition
SG	MicroShield® – an antimicrobial powder coat finish	\$73.00
WBS	Wrought Box Strike	No addition

NOTES: ▲ Options not available with a standard 50 function lockout cylinder. † Not available with 60, 63, 64 options.

CPC	7904 x CEH008 x RH x 32D x CPC (Clear Powder Coat) All orders will continue to be handled as a "special" when CPC is ordered.	\$67.00
-----	--	---------

Experience a safer
and more open world

Copyright © 2002-2021 Sargent Manufacturing Company, an ASSA ABLOY Group company. All rights reserved.
Reproduction in whole or in part without the express written permission of Sargent Manufacturing Company is prohibited.
Contact us at: 800-727-5477 or visit www.sargentlock.com. In Canada contact us at: 800-461-3007 or visit www.assaabloydss.ca

USA & Canada Prices Effective May 1, 2021

Escutcheon Design:

CE
TE
LE1

Lever Designs:

H003, H004, H005, H006, H007, *H008, H009, H010, H011



H007



H008

How to order:

21-7904 x CEH003 x RH x 10BE
Option 60
Function 7904
Escutcheon CE
Lever H008
Hand RH
Finish 10BE

* Handed - specify hand when ordering.

Function		Finish	
		10BE/26D/BSP/WSP	03/04/09/10/10B/10BL/14/15/20D/26/32/32D
Single Cyl			
7904	Storeroom or Closet		
7937	Classroom	\$980.00	\$1,004.00
7955	Office or Entry		
Single Cyl With Deadbolt			
7924	Room Door		
7925	Dormitory or Exit		
7943	Apartment Corridor	\$1,002.00	\$1,026.00
7945	Dormitory or Exit		
7950	Hotel Guest Lock	\$1,077.00	\$1,101.00
Double Cyl No Deadbolt			
7916	Apartment or Exit or Public Toilet	\$1,071.00	\$1,095.00
7938	Classroom Security Intruder		
Double Cyl With Deadbolt			
7926	Store Door	\$1,088.00	\$1,112.00
Electro Mechanical Single Cyl – Specify 12V or 24V			
7970-12V / 7970-24V	Fail Safe	\$1,296.00	\$1,320.00
7971-12V / 7971-24V	Fail Secure		
Electro Mechanical Double Cyl – Specify 12V or 24V			
7972-12V / 7972-24V	Fail Safe	\$1,380.00	\$1,404.00
7973-12V / 7973-24V	Fail Secure		
Non Keyed			
7915	Passage or Closet	\$793.00	\$817.00
7965	Privacy Bedroom or Bath (Latch)	\$900.00	\$924.00
7966	Privacy Bedroom or Bath (Deadbolt)	\$938.00	\$962.00
7993	Single Dummy Trim	\$404.00	\$428.00
7994	Double Dummy Trim	\$678.00	\$702.00
7995	Single Dummy Trim w/Lockbody	\$496.00	\$520.00

ML-140 MORTISE LOCKS

SARGENT®

ASSA ABLOY

OPTIONS

USA & Canada Prices Effective May 1, 2021

Options	Description	Price
1▲	7900 Line with 1-1/16" wide front for 1-3/8" doors.	\$62.00
10▲	SARGENT Signature Key System	\$63.00 / cyl.
11†▲	SARGENT XC Key System (not available with 10, 22, SC, SE options)	No addition
1160	SARGENT XC Large Format Interchangeable Plastic Disposable Construction Core	No addition
1163	SARGENT XC Large Format Interchangeable Core Cylinder - Includes masterkeying charges	\$83.00
1164	SARGENT XC Large Format Interchangeable Construction Core Cylinder	\$83.00
1170	Small Format interchangeable disposable construction core - to accept 7 Pin XC permanent core	No addition
11727P	Small Format interchangeable keyed construction core - to accept 7 Pin XC permanent core	\$75.00
11737P	Small Format interchangeable core - to accept 7 pin XC permanent core	\$75.00 / cyl.
21▲†	SARGENT Construction Key System (lost ball) Standard on all new systems established since 5/1/96	\$16.00 / cyl.
22▲†	SARGENT Construction Key System (split key) To be used on pre-established split key systems only	\$32.00 / cyl.
31	Thick Doors - Extended Lip Required - Specify Length C to E - Cylinders - IMPORTANT- See catalog 7800/8200 option page for cylinder limitations - Below charges DO NOT include additional charges for special cylinder requirements	
	Doors up to 2-1/2" thick - lock centered	No addition
	Doors 2-5/8" to 6" thick OR doors 1-3/4" thick w/max 1" paneling one side. For example: Specify 1-3/4" door with panel (Side) on inside or outside	Non Keyed function \$50.00 Keyed function \$100.00
60	SARGENT Large Format Interchangeable Plastic Disposable Construction Core	No addition
63	SARGENT Large Format Interchangeable core cylinder, includes master keying charges	\$83.00 / cyl.
64	SARGENT Large Format Interchangeable Construction Core Cylinder	\$83.00
6573▲†	Small Format 6-Pin Uncombined Core (Refer to CK-12)	\$65.00 / cyl.
65737P▲†	Small Format 7-Pin Uncombined Core (Refer to CK-12)	\$65.00 / cyl.
70▲†	Small Format Interchangeable disposable plastic construction core	No addition
72▲†	Small Format Interchangeable 6-pin construction core (7-pin with 11 option)	\$75.00
73▲†	Small Format interchangeable core 6-pin Includes MK and GMK keying charges	\$75.00 / cyl
737P▲†	Small Format interchangeable core 7-pin (refer to CK-12 for available keyways) Includes MK and GMK keying charges	\$75.00 / cyl
F182▲†	SARGENT Keso Security Cylinder – patented – new key systems	\$91.00 / cyl.
F183▲†	SARGENT Keso Security Removable Core Cylinder – patented – new key systems	\$130.00 / cyl.
81▲†	Cylinder to accept Keso (83) and Keso F1(F183) Removable Core – no core provided	No addition
82▲†	SARGENT Keso Security Cylinder (For existing systems only)	\$91.00 / cyl.
83▲†	SARGENT Keso Security Removable Core Cylinder (For existing systems only)	\$130.00 / cyl.
84▲†	SARGENT Keso Security Removable Construction Core Cylinder	See CK-18
85	Tactile Warning - Abrasive coating on inside lever	\$49.00
86	Tactile Warning - Abrasive coating on outside lever	\$49.00
87	Tactile Warning - Abrasive coating on both levers	\$98.00
BR	SARGENT Bump Resistant Cyls. (N/A w/10, 22, 30, 60, 63, 64, 70,72, 73, 737P, KESO, SC, SE)	\$25.00 /cyl.
DG1	Patented Degree DG1 Key System	No addition
DG160	Hardware prepared for DG1-6300 Lg. Format IC cores, supplied with temporary plastic construction cores	No addition
DG163	Patented Degree DG1 Large Format Interchangeable Core Cylinder - Includes master keying charges	\$83.00
DG164	Hardware prepared for DG1-6300 Lg. Format IC cores, supplied with temporary keyed construction cores	\$83.00
DG2	Patented Degree DG2 Key System incorporating a locking sidebar	\$63.00/cyl.
DG260	Hardware prepared for DG2-6300 Lg. Format IC cores, supplied with temporary plastic construction cores	No addition
DG263	Patented Degree DG2 Large Format Interchangeable Core Cylinder - Includes master keying charges	\$146.00
DG264	Hardware prepared for DG2-6300 Lg. Format IC cores, supplied with temporary keyed construction cores	\$83.00
DG3	Patented Degree DG3 Key System incorporating a locking sidebar and UL437 listed	\$89.00/cyl.
DG360	Hardware prepared for DG3-6300 Lg. Format IC cores, supplied with temporary plastic construction cores	No addition
DG363	Patented Degree DG3 Large Format Interchangeable Core Cylinder - Includes master keying charges	\$172.00
DG364	Hardware prepared for DG3-6300 Lg. Format IC cores, supplied with temporary keyed construction cores	\$83.00
LC	Less Cylinder	-\$96.00/cyl.
OBS	Open Back Strike	\$79.00
RX	Request to Exit	\$206.00
SC▲†	Schlage "C" Keyway cylinder, (Number 41 Cylinder Only, 0 bitted)	No addition
SE▲†	Schlage "E" Keyway cylinder, (Number 41 Cylinder Only, 0 bitted)	No addition
SG	MicroShield® – an antimicrobial powder coat finish	\$73.00
WBS	Wrought Box Strike	No addition

NOTES: ▲ Options not available with a standard 50 function lockout cylinder. † Not available with 60, 63, 64 options.

CPC	7904 x CEMD x RH x 32D x CPC (Clear Powder Coat) All orders will continue to be handled as a "special" when CPC is ordered.	\$67.00
-----	--	---------

Experience a safer
and more open world

Copyright © 2002-2021 Sargent Manufacturing Company, an ASSA ABLOY Group company. All rights reserved.
Reproduction in whole or in part without the express written permission of Sargent Manufacturing Company is prohibited.
Contact us at: 800-727-5477 or visit www.sargentlock.com. In Canada contact us at: 800-461-3007 or visit www.assaabloydss.ca

Escutcheon Design:

CE
TE
LE1

Studio Lever Designs:

All Studio Collection Levers (except Gramercy Series)

How to order:

21-7904 x CEMD x RH x 26D
Option 60
Function 7904
Rose CE
Lever MD
Hand RH
Finish 26D

Function		Finish	
		10BE/26D/BSP/WSP	03/04/09/10/10B/10BL/14/15/20D/26/32/32D
Single Cyl			
7904	Storeroom or Closet		
7937	Classroom	\$850.00	\$874.00
7955	Office or Entry		
Single Cyl With Deadbolt			
7924	Room Door		
7925	Dormitory or Exit		
7943	Apartment Corridor	\$872.00	\$896.00
7945	Dormitory or Exit		
7950	Hotel Guest Lock	\$947.00	\$971.00
Double Cyl No Deadbolt			
7916	Apartment or Exit or Public Toilet	\$941.00	\$965.00
7938	Classroom Security Intruder		
Double Cyl With Deadbolt			
7926	Store Door	\$957.00	\$981.00
Electro Mechanical Single Cyl – Specify 12V or 24V			
7970-12V / 7970-24V	Fail Safe	\$1,165.00	\$1,189.00
7971-12V / 7971-24V	Fail Secure		
Electro Mechanical Double Cyl – Specify 12V or 24V			
7972-12V / 7972-24V	Fail Safe	\$1,250.00	\$1,274.00
7973-12V / 7973-24V	Fail Secure		
Non Keyed			
7915	Passage or Closet	\$663.00	\$687.00
7965	Privacy Bedroom or Bath (Latch)	\$769.00	\$793.00
7966	Privacy Bedroom or Bath (Deadbolt)	\$807.00	\$831.00
7993	Single Dummy Trim	\$274.00	\$286.00
7994	Double Dummy Trim	\$547.00	\$571.00
7995	Single Dummy Trim w/Lockbody	\$365.00	\$377.00

ML-142 MORTISE LOCKS

SARGENT®

ASSA ABLOY

OPTIONS

USA & Canada Prices Effective May 1, 2021

Options	Description	Price
1▲	7900 Line with 1-1/16" wide front for 1-3/8" doors.	\$62.00
10▲	SARGENT Signature Key System	\$63.00 / cyl.
11†▲	SARGENT XC Key System (not available with 10, 22, SC, SE options)	No addition
1160	SARGENT XC Large Format Interchangeable Plastic Disposable Construction Core	No addition
1163	SARGENT XC Large Format Interchangeable Core Cylinder - Includes masterkeying charges	\$83.00
1164	SARGENT XC Large Format Interchangeable Construction Core Cylinder	\$83.00
1170	Small Format interchangeable disposable construction core - to accept 7 Pin XC permanent core	No addition
11727P	Small Format interchangeable keyed construction core - to accept 7 Pin XC permanent core	\$75.00
11737P	Small Format interchangeable core - to accept 7 pin XC permanent core	\$75.00 / cyl.
21▲†	SARGENT Construction Key System (lost ball) Standard on all new systems established since 5/1/96	\$16.00 / cyl.
22▲†	SARGENT Construction Key System (split key) To be used on pre-established split key systems only	\$32.00 / cyl.
31	Thick Doors - Extended Lip Required - Specify Length C to E - Cylinders - IMPORTANT- See catalog 7800/8200 option page for cylinder limitations - Below charges DO NOT include additional charges for special cylinder requirements	No addition
	Doors up to 2-1/2" thick - lock centered	No addition
	Doors 2-5/8" to 6" thick OR doors 1-3/4" thick w/max 1" paneling one side. For example: Specify 1-3/4" door with panel (Side) on inside or outside	Non Keyed function \$50.00 Keyed function \$100.00
60	SARGENT Large Format Interchangeable Plastic Disposable Construction Core	No addition
63	SARGENT Large Format Interchangeable core cylinder, includes master keying charges	\$83.00 / cyl.
64	SARGENT Large Format Interchangeable Construction Core Cylinder	\$83.00
6573▲†	Small Format 6-Pin Uncombined Core (Refer to CK-12)	\$65.00 / cyl.
65737P▲†	Small Format 7-Pin Uncombined Core (Refer to CK-12)	\$65.00 / cyl.
70▲†	Small Format Interchangeable disposable plastic construction core	No addition
72▲†	Small Format Interchangeable 6-pin construction core (7-pin with 11 options)	\$75.00
73▲†	Small Format interchangeable core 6-pin Includes MK and GMK keying charges	\$75.00 / cyl
737P▲†	Small Format interchangeable core 7-pin (refer to CK-12 for available keyways) Includes MK and GMK keying charges	\$75.00 / cyl
F182▲†	SARGENT Keso Security Cylinder – patented – new key systems	\$91.00 / cyl.
F183▲†	SARGENT Keso Security Removable Core Cylinder – patented – new key systems	\$130.00 / cyl.
81▲†	Cylinder to accept Keso (83) and Keso F1(F183) Removable Core – no core provided	No addition
82▲†	SARGENT Keso Security Cylinder (For existing systems only)	\$91.00 / cyl.
83▲†	SARGENT Keso Security Removable Core Cylinder (For existing systems only)	\$130.00 / cyl.
84▲†	SARGENT Keso Security Removable Construction Core Cylinder	See CK-18
BR	SARGENT Bump Resistant Cylinders (N/A w/10, 22, 30, 60, 63, 64, 70, 72, 73, 737P, KESO, SC, & SE options)	\$25.00 /cyl.
DG1	Patented Degree DG1 Key System	No addition
DG160	Hardware prepared for DG1-6300 Lg. Format IC cores, supplied with temporary plastic construction cores	No addition
DG163	Patented Degree DG1 Large Format Interchangeable Core Cylinder - Includes master keying charges	\$83.00
DG164	Hardware prepared for DG1-6300 Lg. Format IC cores, supplied with temporary keyed construction cores	\$83.00
DG2	Patented Degree DG2 Key System incorporating a locking sidebar	\$63.00/cyl.
DG260	Hardware prepared for DG2-6300 Lg. Format IC cores, supplied with temporary plastic construction cores	No addition
DG263	Patented Degree DG2 Large Format Interchangeable Core Cylinder - Includes master keying charges	\$146.00
DG264	Hardware prepared for DG2-6300 Lg. Format IC cores, supplied with temporary keyed construction cores	\$83.00
DG3	Patented Degree DG3 Key System incorporating a locking sidebar and UL437 listed	\$89.00/cyl.
DG360	Hardware prepared for DG3-6300 Lg. Format IC cores, supplied with temporary plastic construction cores	No addition
DG363	Patented Degree DG3 Large Format Interchangeable Core Cylinder - Includes master keying charges	\$172.00
DG364	Hardware prepared for DG3-6300 Lg. Format IC cores, supplied with temporary keyed construction cores	\$83.00
LC	Less Cylinder	-\$96.00/cyl.
OBS	Open Back Strike	\$79.00
RX	Request to Exit	\$206.00
SC▲†	Schlage "C" Keyway cylinder, (Number 41 Cylinder Only, 0 bitted)	No addition
SE▲†	Schlage "E" Keyway cylinder, (Number 41 Cylinder Only, 0 bitted)	No addition
SG	MicroShield® – an antimicrobial powder coat finish	\$73.00
T1	Decorative thumbturn; backplate matches rose design chosen	No Addition
T2	Decorative square thumbturn; backplate matches rose design chosen	No Addition
T3	Decorative cylinder thumbturn; backplate matches rose design chosen	No Addition
WBS	Wrought Box Strike	No addition

NOTES: ▲ Options not available with a standard 50 function lockout cylinder. † Not available with 60, 63, 64 options.

CPC	7904 x OREM x RH x 32D x CPC (Clear Powder Coat) All orders will continue to be handled as a "special" when CPC is ordered.	\$67.00
-----	--	---------

Experience a safer
and more open world

Copyright © 2002-2021 Sargent Manufacturing Company, an ASSA ABLOY Group company. All rights reserved.
Reproduction in whole or in part without the express written permission of Sargent Manufacturing Company is prohibited.
Contact us at: 800-727-5477 or visit www.sargentlock.com. In Canada contact us at: 800-461-3007 or visit www.assaabloydss.ca

USA & Canada Prices Effective May 1, 2021

Rose Design:

CO (2-3/4")
CR (2-3/16")
LN (2")
O (2-3/4")
TO (2-3/4")
TR (2-3/16")
E2 (2-11/16")
E3 (2-1/16")
E4 (3-1/3")

Lever Design:

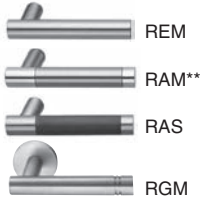

How to order Gramercy Series Levers:

Option: 21 x Function: 7904 x Rose: CO x Lever: RAM x Finish: 29BK29 x Hand: RH

See below for available finishes:

Lever Design Available Finishes

Lever Design	Available Finishes
REM-RGM	2930 or 3030
RAM	2930*
RAS	29BK29, 30BK30

*Two-tone - grip of lever is 32D, balance of lever is 32. Rose/escutcheon and lock finish will be 32.
See catalog for finish description.

**RAM is not available in 10BE/BSP/WSP finish.

Function – Single Cylinder	Finish – 10BE/BSP/WSP/629/630
7904 Storeroom or Closet	
7937 Classroom	\$879.00
7955 Office or Entry	
Single Cylinder With Deadbolt	
7924 Room Door	
7925 Dormitory or Exit	
7943 Apartment Corridor	\$903.00
7945 Dormitory or Exit	
7950 Hotel Guest Lock	\$969.00
Double Cylinder No Deadbolt	
7916 Apartment or Exit or Public Toilet	\$966.00
7938 Classroom Security Intruder	
Double Cylinder With Deadbolt	
7926 Store Door	\$983.00
Electro Mechanical Single Cylinder – Specify 12V or 24V	
7970-12V / 7970-24V Fail Safe	\$1,195.00
7971-12V / 7971-24V Fail Secure	
Electro Mechanical Double Cylinder – Specify 12V or 24V	
7972-12V / 7972-24V Fail Safe	\$1,281.00
7973-12V / 7973-24V Fail Secure	
Non Keyed	
7915 Passage or Closet	\$703.00
7965 Privacy Bedroom or Bath (Latch)	\$802.00
7966 Privacy Bedroom or Bath (Deadbolt)	\$840.00
7993 Single Dummy Trim	\$294.00
7994 Double Dummy Trim	\$585.00
7995 Single Dummy Trim w/Lockbody	\$385.00

ML-144 MORTISE LOCKS

SARGENT®

OPTIONS

ASSA ABLOY

USA & Canada Prices Effective May 1, 2021

Options	Description	Price
1▲	7900 Line with 1-1/16" wide front for 1-3/8" doors.	\$62.00
10▲	SARGENT Signature Key System	\$63.00 / cyl.
11†▲	SARGENT XC Key System (not available with 10, 22, SC, SE options)	No addition
1160	SARGENT XC Large Format Interchangeable Plastic Disposable Construction Core	No addition
1163	SARGENT XC Large Format Interchangeable Core Cylinder - Includes masterkeying charges	\$83.00
1164	SARGENT XC Large Format Interchangeable Construction Core Cylinder	\$83.00
1170	Small Format interchangeable disposable construction core - to accept 7 Pin XC permanent core	No addition
11727P	Small Format interchangeable keyed construction core - to accept 7 Pin XC permanent core	\$75.00
11737P	Small Format interchangeable core - to accept 7 pin XC permanent core	\$75.00 / cyl.
21▲†	SARGENT Construction Key System (lost ball) Standard on all new systems established since 5/1/96	\$16.00 / cyl.
22▲†	SARGENT Construction Key System (split key) To be used on pre-established split key systems only	\$32.00 / cyl.
31	Thick Doors - Extended Lip Required - Specify Length C to E - Cylinders - IMPORTANT- See catalog 7800/8200 option page for cylinder limitations - Below charges DO NOT include additional charges for special cylinder requirements	
	Doors up to 2-1/2" thick - lock centered	No addition
	Doors 2-5/8" to 6" thick OR doors 1-3/4" thick w/max 1" paneling one side. For example: Specify 1-3/4" door with panel (Side) on inside or outside	Non Keyed function \$50.00 Keyed function \$100.00
60	SARGENT Large Format Interchangeable Plastic Disposable Construction Core	No addition
63	SARGENT Large Format Interchangeable core cylinder, includes master keying charges	\$83.00 / cyl.
64	SARGENT Large Format Interchangeable Construction Core Cylinder	\$83.00
6573▲†	Small Format 6-Pin Uncombined Core (Refer to CK-12)	\$65.00 / cyl.
65737P▲†	Small Format 7-Pin Uncombined Core (Refer to CK-12)	\$65.00 / cyl.
70▲†	Small Format Interchangeable disposable plastic construction core	No addition
72▲†	Small Format Interchangeable 6-pin construction core (7-pin with 11 options)	\$75.00
73▲†	Small Format interchangeable core 6-pin Includes MK and GMK keying charges	\$75.00 / cyl
737P▲†	Small Format interchangeable core 7-pin (refer to CK-12 for available keyways) Includes MK and GMK keying charges	\$75.00 / cyl
F182▲†	SARGENT Keso Security Cylinder – patented – new key systems	\$91.00 / cyl.
F183▲†	SARGENT Keso Security Removable Core Cylinder – patented – new key systems	\$130.00 / cyl.
81▲†	Cylinder to accept Keso (83) and Keso F1(F183) Removable Core – no core provided	No addition
82▲†	SARGENT Keso Security Cylinder (For existing systems only)	\$91.00 / cyl.
83▲†	SARGENT Keso Security Removable Core Cylinder (For existing systems only)	\$130.00 / cyl.
84▲†	SARGENT Keso Security Removable Construction Core Cylinder	See CK-18
BR	SARGENT Bump Resistant Cylinders (N/A w/10, 22, 30, 60, 63, 64, 70, 72, 73, 737P, KESO, SC, & SE options)	\$25.00 /cyl.
DG1	Patented Degree DG1 Key System	No addition
DG160	Hardware prepared for DG1-6300 Lg. Format IC cores, supplied with temporary plastic construction cores	No addition
DG163	Patented Degree DG1 Large Format Interchangeable Core Cylinder - Includes master keying charges	\$83.00
DG164	Hardware prepared for DG1-6300 Lg. Format IC cores, supplied with temporary keyed construction cores	\$83.00
DG2	Patented Degree DG2 Key System incorporating a locking sidebar	\$63.00/cyl.
DG260	Hardware prepared for DG2-6300 Lg. Format IC cores, supplied with temporary plastic construction cores	No addition
DG263	Patented Degree DG2 Large Format Interchangeable Core Cylinder - Includes master keying charges	\$146.00
DG264	Hardware prepared for DG2-6300 Lg. Format IC cores, supplied with temporary keyed construction cores	\$83.00
DG3	Patented Degree DG3 Key System incorporating a locking sidebar and UL437 listed	\$89.00/cyl.
DG360	Hardware prepared for DG3-6300 Lg. Format IC cores, supplied with temporary plastic construction cores	No addition
DG363	Patented Degree DG3 Large Format Interchangeable Core Cylinder - Includes master keying charges	\$172.00
DG364	Hardware prepared for DG3-6300 Lg. Format IC cores, supplied with temporary keyed construction cores	\$83.00
LC	Less Cylinder	-\$96.00/cyl.
OBS	Open Back Strike	\$79.00
RX	Request to Exit	\$206.00
SC▲†	Schlage "C" Keyway cylinder, (Number 41 Cylinder Only, 0 bitted)	No addition
SE▲†	Schlage "E" Keyway cylinder, (Number 41 Cylinder Only, 0 bitted)	No addition
SG	MicroShield® – an antimicrobial powder coat finish	\$73.00
T1	Decorative thumbturn; backplate matches rose design chosen	No Addition
T2	Decorative square thumbturn; backplate matches rose design chosen	No Addition
T3	Decorative cylinder thumbturn; backplate matches rose design chosen	No Addition
WBS	Wrought Box Strike	No addition

NOTES: ▲ Options not available with a standard 50 function lockout cylinder. † Not available with 60, 63, 64 options.

CPC	7904 x ORCM x RH x 32D x CPC (Clear Powder Coat) All orders will continue to be handled as a "special" when CPC is ordered.	\$67.00
-----	--	---------

Experience a safer
and more open world

Copyright © 2002-2021 Sargent Manufacturing Company, an ASSA ABLOY Group company. All rights reserved.
Reproduction in whole or in part without the express written permission of Sargent Manufacturing Company is prohibited.
Contact us at: 800-727-5477 or visit www.sargentlock.com. In Canada contact us at: 800-461-3007 or visit www.assaabloydss.ca

7900 SERIES — STUDIO COLLECTION GRAMERCY SERIES

USA & Canada Prices Effective May 1, 2021

Rose Design:

CO (2-3/4")
CR (2-3/16")
LN (2")
O (2-3/4")
TO (2-3/4")
TR (2-3/16")
E2 (2-11/16")
E3 (2-1/16")
E4 (3-1/3")

Lever Design:

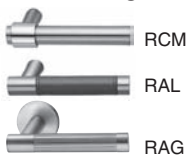

How to order Gramercy Series Levers:

Option: 63 x Function: 7904 x Rose: TR x Lever: RAL x Finish: 29BK29 x Hand: RH

See below for available finishes:

Lever Design Available Finishes

RCM 2929, 3030, or 2930*
RAL 29BK29, 29BN29, 30BK30, or 30BN30
RAG 2929 or 3030

*Two-tone - grip of lever is 32D, balance of lever is 32. Rose/escutcheon and lock finish will be 32. See catalog for finish description.

Function – Single Cylinder		Finish – 10BE/BSP/WSP/629/630
7904	Storeroom or Closet	
7937	Classroom	\$944.00
7955	Office or Entry	
Single Cylinder With Deadbolt		
7924	Room Door	
7925	Dormitory or Exit	
7943	Apartment Corridor	\$966.00
7945	Dormitory or Exit	
7950	Hotel Guest Lock	\$1,033.00
Double Cylinder No Deadbolt		
7916	Apartment or Exit or Public Toilet	\$1,027.00
7938	Classroom Security Intruder	
Double Cylinder With Deadbolt		
7926	Store Door	\$1,040.00
Electro Mechanical Single Cylinder – Specify 12V or 24V		
7970-12V / 7970-24V	Fail Safe	\$1,241.00
7971-12V / 7971-24V	Fail Secure	
Electro Mechanical Double Cylinder – Specify 12V or 24V		
7972-12V / 7972-24V	Fail Safe	\$1,319.00
7973-12V / 7973-24V	Fail Secure	
Non Keyed		
7915	Passage or Closet	\$778.00
7965	Privacy Bedroom or Bath (Latch)	\$875.00
7966	Privacy Bedroom or Bath (Deadbolt)	\$908.00
7993	Single Dummy Trim	\$404.00
7994	Double Dummy Trim	\$672.00
7995	Single Dummy Trim w/Lockbody	\$490.00

ML-146 MORTISE LOCKS

SARGENT®

ASSA ABLOY

OPTIONS

USA & Canada Prices Effective May 1, 2021

Options	Description	Price
1▲	7900 Line with 1-1/16" wide front for 1-3/8" doors.	\$62.00
10▲	SARGENT Signature Key System	\$63.00 / cyl.
11†▲	SARGENT XC Key System (not available with 10, 22, SC, SE options)	No addition
1160	SARGENT XC Large Format Interchangeable Plastic Disposable Construction Core	No addition
1163	SARGENT XC Large Format Interchangeable Core Cylinder - Includes masterkeying charges	\$83.00
1164	SARGENT XC Large Format Interchangeable Construction Core Cylinder	\$83.00
1170	Small Format interchangeable disposable construction core - to accept 7 Pin XC permanent core	No addition
11727P	Small Format interchangeable keyed construction core - to accept 7 Pin XC permanent core	\$75.00
11737P	Small Format interchangeable core - to accept 7 pin XC permanent core	\$75.00 / cyl.
21▲†	SARGENT Construction Key System (lost ball) Standard on all new systems established since 5/1/96	\$16.00 / cyl.
22▲†	SARGENT Construction Key System (split key) To be used on pre-established split key systems only	\$32.00 / cyl.
31	Thick Doors - Extended Lip Required - Specify Length C to E - Cylinders - IMPORTANT- See catalog 7800/8200 option page for cylinder limitations - Below charges DO NOT include additional charges for special cylinder requirements	
	Doors up to 2-1/2" thick - lock centered	No addition
	Doors 2-5/8" to 6" thick OR doors 1-3/4" thick w/max 1" paneling one side. For example: Specify 1-3/4" door with panel (Side) on inside or outside	Non Keyed function \$50.00 Keyed function \$100.00
60	SARGENT Large Format Interchangeable Plastic Disposable Construction Core	No addition
63	SARGENT Large Format Interchangeable core cylinder, includes master keying charges	\$83.00 / cyl.
64	SARGENT Large Format Interchangeable Construction Core Cylinder	\$83.00
6573▲†	Small Format 6-Pin Uncombined Core (Refer to CK-12)	\$65.00 / cyl.
65737P▲†	Small Format 7-Pin Uncombined Core (Refer to CK-12)	\$65.00 / cyl.
70▲†	Small Format Interchangeable disposable plastic construction core	No addition
72▲†	Small Format Interchangeable 6-pin construction core (7-pin with 11 option)	\$75.00
73▲†	Small Format interchangeable core 6-pin Includes MK and GMK keying charges	\$75.00 / cyl
737P▲†	Small Format interchangeable core 7-pin (refer to CK-12 for available keyways) Includes MK and GMK keying charges	\$75.00 / cyl
F182▲†	SARGENT Keso Security Cylinder – patented – new key systems	\$91.00 / cyl.
F183▲†	SARGENT Keso Security Removable Core Cylinder – patented – new key systems	\$130.00 / cyl.
81▲†	Cylinder to accept Keso (83) and Keso F1(F183) Removable Core – no core provided	No addition
82▲†	SARGENT Keso Security Cylinder (For existing systems only)	\$91.00 / cyl.
83▲†	SARGENT Keso Security Removable Core Cylinder (For existing systems only)	\$130.00 / cyl.
84▲†	SARGENT Keso Security Removable Construction Core Cylinder	See CK-18
BR	SARGENT Bump Resistant Cyls. (N/A w/10, 22, 30, 60, 63, 64, 70,72, 73, 737P, KESO, SC, SE)	\$25.00 /cyl.
DG1	Patented Degree DG1 Key System	No addition
DG160	Hardware prepared for DG1-6300 Lg. Format IC cores, supplied with temporary plastic construction cores	No addition
DG163	Patented Degree DG1 Large Format Interchangeable Core Cylinder - Includes master keying charges	\$83.00
DG164	Hardware prepared for DG1-6300 Lg. Format IC cores, supplied with temporary keyed construction cores	\$83.00
DG2	Patented Degree DG2 Key System incorporating a locking sidebar	\$63.00/cyl.
DG260	Hardware prepared for DG2-6300 Lg. Format IC cores, supplied with temporary plastic construction cores	No addition
DG263	Patented Degree DG2 Large Format Interchangeable Core Cylinder - Includes master keying charges	\$146.00
DG264	Hardware prepared for DG2-6300 Lg. Format IC cores, supplied with temporary keyed construction cores	\$83.00
DG3	Patented Degree DG3 Key System incorporating a locking sidebar and UL437 listed	\$89.00/cyl.
DG360	Hardware prepared for DG3-6300 Lg. Format IC cores, supplied with temporary plastic construction cores	No addition
DG363	Patented Degree DG3 Large Format Interchangeable Core Cylinder - Includes master keying charges	\$172.00
DG364	Hardware prepared for DG3-6300 Lg. Format IC cores, supplied with temporary keyed construction cores	\$83.00
LC	Less Cylinder	-\$96.00/cyl.
OBS	Open Back Strike	\$79.00
RX	Request to Exit	\$206.00
SC▲†	Schlage "C" Keyway cylinder, (Number 41 Cylinder Only, 0 bitted)	No addition
SE▲†	Schlage "E" Keyway cylinder, (Number 41 Cylinder Only, 0 bitted)	No addition
SG	MicroShield® – an antimicrobial powder coat finish	\$73.00
WBS	Wrought Box Strike	No addition

NOTES: ▲ Options not available with a standard 50 function lockout cylinder. † Not available with 60, 63, 64 options.

CPC	7904 x LW1MC x RH x 32D x CPC (Clear Powder Coat) All orders will continue to be handled as a "special" when CPC is ordered.	\$67.00
-----	---	---------

Experience a safer
and more open world

Copyright © 2002-2021 Sargent Manufacturing Company, an ASSA ABLOY Group company. All rights reserved.
Reproduction in whole or in part without the express written permission of Sargent Manufacturing Company is prohibited.
Contact us at: 800-727-5477 or visit www.sargentlock.com. In Canada contact us at: 800-461-3007 or visit www.assaabloydss.ca

7900 SERIES — STUDIO COLLECTION GRAMERCY SERIES

USA & Canada Prices Effective May 1, 2021

Esc. Design:

CE
TE
LE1

Lever Design:

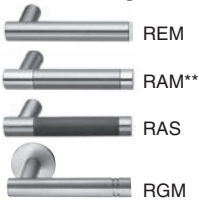

How to order Gramercy Series Levers:

Option: LC x Function: 7904 x Esc.: CE x Lever: REM x Finish: 29BK29 x Hand: RH

See below for available finishes:

Lever Design Available Finishes

REM-RGM	2930 or 3030
RAM	2930*
RAS	29BK29, 30BK30

*Two-tone - grip of lever is 32D, balance of lever is 32. Rose/escutcheon and lock finish will be 32.
See catalog for finish description.

**RAM is not available in 10BE/BSP/WSP finish

Function – Single Cylinder		Finish – 10BE/BSP/WSP/629/630
7904	Storeroom or Closet	
7937	Classroom	\$928.00
7955	Office or Entry	
Single Cyl With Deadbolt		
7924	Room Door	
7925	Dormitory or Exit	
7943	Apartment Corridor	\$945.00
7945	Dormitory or Exit	
7950	Hotel Guest Lock	\$1,027.00
Double Cyl No Deadbolt		
7916	Apartment or Exit or Public Toilet	\$1,015.00
7938	Classroom Security Intruder	
Double Cyl With Deadbolt		
7926	Store Door	\$1,034.00
Electro Mechanical Single Cyl – Specify 12V or 24V		
7970-12V / 7970-24V	Fail Safe	\$1,247.00
7971-12V / 7971-24V	Fail Secure	
Electro Mechanical Double Cyl – Specify 12V or 24V		
7972-12V / 7972-24V	Fail Safe	\$1,328.00
7973-12V / 7973-24V	Fail Secure	
Non Keyed		
7915	Passage or Closet	\$737.00
7965	Privacy Bedroom or Bath (Latch)	\$844.00
7966	Privacy Bedroom or Bath (Deadbolt)	\$880.00
7993	Single Dummy Trim	\$312.00
7994	Double Dummy Trim	\$618.00
7995	Single Dummy Trim w/Lockbody	\$401.00

ML-148 MORTISE LOCKS

SARGENT®

ASSA ABLOY

OPTIONS

USA & Canada Prices Effective May 1, 2021

Options	Description	Price
1▲	7900 Line with 1-1/16" wide front for 1-3/8" doors.	\$62.00
10▲	SARGENT Signature Key System	\$63.00 / cyl.
11†▲	SARGENT XC Key System (not available with 10, 22, SC, SE options)	No addition
1160	SARGENT XC Large Format Interchangeable Plastic Disposable Construction Core	No addition
1163	SARGENT XC Large Format Interchangeable Core Cylinder - Includes masterkeying charges	\$83.00
1164	SARGENT XC Large Format Interchangeable Construction Core Cylinder	\$83.00
1170	Small Format interchangeable disposable construction core - to accept 7 Pin XC permanent core	No addition
11727P	Small Format interchangeable keyed construction core - to accept 7 Pin XC permanent core	\$75.00
11737P	Small Format interchangeable core - to accept 7 pin XC permanent core	\$75.00 / cyl.
21▲†	SARGENT Construction Key System (lost ball) Standard on all new systems established since 5/1/96	\$16.00 / cyl.
22▲†	SARGENT Construction Key System (split key) To be used on pre-established split key systems only	\$32.00 / cyl.
31	Thick Doors - Extended Lip Required - Specify Length C to E - Cylinders - IMPORTANT- See catalog 7800/8200 option page for cylinder limitations - Below charges DO NOT include additional charges for special cylinder requirements	
	Doors up to 2-1/2" thick - lock centered	No addition
	Doors 2-5/8" to 6" thick OR doors 1-3/4" thick w/max 1" paneling one side. For example: Specify 1-3/4" door with panel (Side) on inside or outside	
		Non Keyed function \$50.00 Keyed function \$100.00
60	SARGENT Large Format Interchangeable Plastic Disposable Construction Core	No addition
63	SARGENT Large Format Interchangeable core cylinder, includes master keying charges	\$83.00 / cyl.
64	SARGENT Large Format Interchangeable Construction Core Cylinder	\$83.00
6573▲†	Small Format 6-Pin Uncombined Core (Refer to CK-12)	\$65.00 / cyl.
65737P▲†	Small Format 7-Pin Uncombined Core (Refer to CK-12)	\$65.00 / cyl.
70▲†	Small Format Interchangeable disposable plastic construction core	No addition
72▲†	Small Format Interchangeable 6-pin construction core (7-pin with 11 option)	\$75.00
73▲†	Small Format interchangeable core 6-pin Includes MK and GMK keying charges	\$75.00 / cyl
737P▲†	Small Format interchangeable core 7-pin (refer to CK-12 for available keyways) Includes MK and GMK keying charges	\$75.00 / cyl
F182▲†	SARGENT Keso Security Cylinder – patented – new key systems	\$91.00 / cyl.
F183▲†	SARGENT Keso Security Removable Core Cylinder – patented – new key systems	\$130.00 / cyl.
81▲†	Cylinder to accept Keso (83) and Keso F1(F183) Removable Core – no core provided	No addition
82▲†	SARGENT Keso Security Cylinder (For existing systems only)	\$91.00 / cyl.
83▲†	SARGENT Keso Security Removable Core Cylinder (For existing systems only)	\$130.00 / cyl.
84▲†	SARGENT Keso Security Removable Construction Core Cylinder	See CK-18
BR	SARGENT Bump Resistant Cyls. (N/A w/10, 22, 30, 60, 63, 64, 70,72, 73, 737P, KESO, SC, SE)	\$25.00 /cyl.
DG1	Patented Degree DG1 Key System	No addition
DG160	Hardware prepared for DG1-6300 Lg. Format IC cores, supplied with temporary plastic construction cores	No addition
DG163	Patented Degree DG1 Large Format Interchangeable Core Cylinder - Includes master keying charges	\$83.00
DG164	Hardware prepared for DG1-6300 Lg. Format IC cores, supplied with temporary keyed construction cores	\$83.00
DG2	Patented Degree DG2 Key System incorporating a locking sidebar	\$63.00/cyl.
DG260	Hardware prepared for DG2-6300 Lg. Format IC cores, supplied with temporary plastic construction cores	No addition
DG263	Patented Degree DG2 Large Format Interchangeable Core Cylinder - Includes master keying charges	\$146.00
DG264	Hardware prepared for DG2-6300 Lg. Format IC cores, supplied with temporary keyed construction cores	\$83.00
DG3	Patented Degree DG3 Key System incorporating a locking sidebar and UL437 listed	\$89.00/cyl.
DG360	Hardware prepared for DG3-6300 Lg. Format IC cores, supplied with temporary plastic construction cores	No addition
DG363	Patented Degree DG3 Large Format Interchangeable Core Cylinder - Includes master keying charges	\$172.00
DG364	Hardware prepared for DG3-6300 Lg. Format IC cores, supplied with temporary keyed construction cores	\$83.00
LC	Less Cylinder	-\$96.00/cyl.
OBS	Open Back Strike	\$79.00
RX	Request to Exit	\$206.00
SC▲†	Schlage "C" Keyway cylinder, (Number 41 Cylinder Only, 0 bitted)	No addition
SE▲†	Schlage "E" Keyway cylinder, (Number 41 Cylinder Only, 0 bitted)	No addition
SG	MicroShield® – an antimicrobial powder coat finish	\$73.00
WBS	Wrought Box Strike	No addition

NOTES: ▲ Options not available with a standard 50 function lockout cylinder. † Not available with 60, 63, 64 options.

CPC	7904 x CERCM x RH x 32D x CPC (Clear Powder Coat) All orders will continue to be handled as a "special" when CPC is ordered.	\$67.00
-----	---	---------

Experience a safer
and more open world

Copyright © 2002-2021 Sargent Manufacturing Company, an ASSA ABLOY Group company. All rights reserved.
Reproduction in whole or in part without the express written permission of Sargent Manufacturing Company is prohibited.
Contact us at: 800-727-5477 or visit www.sargentlock.com. In Canada contact us at: 800-461-3007 or visit www.assaabloydss.ca

7900 SERIES — STUDIO COLLECTION GRAMERCY SERIES

USA & Canada Prices Effective May 1, 2021

Esc. Design:

CE
TE
LE1

Lever Design:

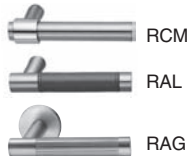

How to order Gramercy Series Levers:

Option: 21 x Function: 7904 x Esc.: TE x Lever: RCM x Finish: 3030 x Hand: RH

See below for available finishes:

Lever Design Available Finishes

RCM 2929, 3030, or 2930*
RAL 29BK29, 29BN29, 30BK30, or 30BN30
RAG 2929 or 3030

*Two-tone - grip of lever is 32D, balance of lever is 32. Rose/escutcheon and lock finish will be 32. See catalog for finish description.

Function – Single Cylinder		Finish – 10BE/BSP/WSP/629/630
7904	Storeroom or Closet	
7937	Classroom	\$990.00
7955	Office or Entry	
Single Cylinder With Deadbolt		
7924	Room Door	
7925	Dormitory or Exit	
7943	Apartment Corridor	\$1,005.00
7945	Dormitory or Exit	
7950	Hotel Guest Lock	\$1,083.00
Double Cylinder No Deadbolt		
7916	Apartment or Exit or Public Toilet	\$1,072.00
7938	Classroom Security Intruder	
Double Cylinder With Deadbolt		
7926	Store Door	\$1,087.00
Electro Mechanical Single Cyl – Specify 12V or 24V		
7970-12V / 7970-24V	Fail Safe	
7971-12V / 7971-24V	Fail Secure	\$1,288.00
Electro Mechanical Double Cylinder – Specify 12V or 24V		
7972-12V / 7972-24V	Fail Safe	\$1,365.00
7973-12V / 7973-24V	Fail Secure	
Non Keyed		
7915	Passage or Closet	\$813.00
7965	Privacy Bedroom or Bath (Latch)	\$910.00
7966	Privacy Bedroom or Bath (Deadbolt)	\$945.00
7993	Single Dummy Trim	\$424.00
7994	Double Dummy Trim	\$701.00
7995	Single Dummy Trim w/Lockbody	\$508.00

ML-150 MORTISE LOCKS

SARGENT®

ASSA ABLOY

OPTIONS

USA & Canada Prices Effective May 1, 2021

Options	Description	Price
1▲	7900 Line with 1-1/16" wide front for 1-3/8" doors.	\$62.00
10▲	SARGENT Signature Key System	\$63.00 / cyl.
11†▲	SARGENT XC Key System (not available with 10, 22, SC, SE options)	No addition
1160	SARGENT XC Large Format Interchangeable Plastic Disposable Construction Core	No addition
1163	SARGENT XC Large Format Interchangeable Core Cylinder - Includes masterkeying charges	\$83.00
1164	SARGENT XC Large Format Interchangeable Construction Core Cylinder	\$83.00
1170	Small Format interchangeable disposable construction core - to accept 7 Pin XC permanent core	No addition
11727P	Small Format interchangeable keyed construction core - to accept 7 Pin XC permanent core	\$75.00
11737P	Small Format interchangeable core - to accept 7 pin XC permanent core	\$75.00 / cyl.
21▲†	SARGENT Construction Key System (lost ball) Standard on all new systems established since 5/1/96	\$16.00 / cyl.
22▲†	SARGENT Construction Key System (split key) To be used on pre-established split key systems only	\$32.00 / cyl.
31	Thick Doors - Extended Lip Required - Specify Length C to E - Cylinders - IMPORTANT- See catalog 7800/8200 option page for cylinder limitations - Below charges DO NOT include additional charges for special cylinder requirements	
	Doors up to 2-1/2" thick - lock centered	No addition
	Doors 2-5/8" to 6" thick OR doors 1-3/4" thick w/max 1" paneling one side. For example: Specify 1-3/4" door with panel (Side) on inside or outside	Non Keyed function \$50.00 Keyed function \$100.00
36	6 Lobe security head screws	\$24.00
37	Spanner head screws	\$17.00
60	SARGENT Large Format Interchangeable Plastic Disposable Construction Core	No addition
63	SARGENT Large Format Interchangeable core cylinder, includes master keying charges	\$83.00 / cyl.
64	SARGENT Large Format Interchangeable Construction Core Cylinder	\$83.00
6573▲†	Small Format 6-Pin Uncombined Core (Refer to CK-12)	\$65.00 / cyl.
65737P▲†	Small Format 7-Pin Uncombined Core (Refer to CK-12)	\$65.00 / cyl.
70▲†	Small Format Interchangeable disposable plastic construction core	No addition
72▲†	Small Format interchangeable 6-pin construction core (7-pin with 11)	\$75.00
73▲†	Small Format interchangeable core 6-pin Includes MK and GMK keying charges	\$75.00 / cyl
737P▲†	Small Format interchangeable core 7-pin (refer to CK-12 for available keyways) Includes MK and GMK keying charges	\$75.00 / cyl
75	Tactile Warning - Milled Inside Knob	\$78.00
76	Tactile Warning - Milled Outside Knob	\$78.00
77	Tactile Warning - Milled Outside and Inside Knob	\$156.00
F182▲†	SARGENT Keso Security Cylinder – patented – new key systems	\$91.00 / cyl.
F183▲†	SARGENT Keso Security Removable Core Cylinder – patented – new key systems	\$130.00 / cyl.
81▲†	Cylinder to accept Keso (83) and Keso F1(F183) Removable Core – no core provided	No addition
82▲†	SARGENT Keso Security Cylinder (For existing systems only)	\$91.00 / cyl.
83▲†	SARGENT Keso Security Removable Core Cylinder (For existing systems only)	\$130.00 / cyl.
84▲†	SARGENT Keso Security Removable Construction Core Cylinder	See CK-18
85	Tactile Warning - Abrasive Coating on Inside Knob	\$49.00
86	Tactile Warning - Abrasive Coating on Outside Knob	\$49.00
87	Tactile Warning - Abrasive Coating on Outside & Inside Knob	\$98.00
BR	SARGENT Bump Resistant Cylinders (N/A w/10, 22, 30, 60, 63, 64, 70, 72, 73, 737P, KESO, SC, & SE options)	\$25.00 /cyl.
DG1	Patented Degree DG1 Key System	No addition
DG160	Hardware prepared for DG1-6300 Lg. Format IC cores, supplied with temporary plastic construction cores	No addition
DG163	Patented Degree DG1 Large Format Interchangeable Core Cylinder - Includes master keying charges	\$83.00
DG164	Hardware prepared for DG1-6300 Lg. Format IC cores, supplied with temporary keyed construction cores	\$83.00
DG2	Patented Degree DG2 Key System incorporating a locking sidebar	\$63.00/cyl.
DG260	Hardware prepared for DG2-6300 Lg. Format IC cores, supplied with temporary plastic construction cores	No addition
DG263	Patented Degree DG2 Large Format Interchangeable Core Cylinder - Includes master keying charges	\$146.00
DG264	Hardware prepared for DG2-6300 Lg. Format IC cores, supplied with temporary keyed construction cores	\$83.00
DG3	Patented Degree DG3 Key System incorporating a locking sidebar and UL437 listed	\$89.00/cyl.
DG360	Hardware prepared for DG3-6300 Lg. Format IC cores, supplied with temporary plastic construction cores	No addition
DG363	Patented Degree DG3 Large Format Interchangeable Core Cylinder - Includes master keying charges	\$172.00
DG364	Hardware prepared for DG3-6300 Lg. Format IC cores, supplied with temporary keyed construction cores	\$83.00
LC	Less Cylinder	-\$96.00/cyl.
OBS	Open Back Strike	\$79.00
SC▲†	Schlage "C" Keyway cylinder, (Number 41 Cylinder Only, 0 bitted)	No addition
SE▲†	Schlage "E" Keyway cylinder, (Number 41 Cylinder Only, 0 bitted)	No addition
SG	MicroShield® – an antimicrobial powder coat finish	\$73.00
WBS	Wrought Box Strike	No addition

NOTES: ▲ Options not available with a standard 50 function lockout cylinder. † Not available with 60, 63, 64 options.

CPC	67-7904 x OB x RH x 32D x CPC (Clear Powder Coat) All orders will continue to be handled as a "special" when CPC is ordered.	\$67.00
-----	---	---------

Experience a safer
and more open world

Copyright © 2002-2021 Sargent Manufacturing Company, an ASSA ABLOY Group company. All rights reserved.
Reproduction in whole or in part without the express written permission of Sargent Manufacturing Company is prohibited.
Contact us at: 800-727-5477 or visit www.sargentlock.com. In Canada contact us at: 800-461-3007 or visit www.assaabloydss.ca



OB

Rose: O (Shown) Knob: B (Shown)

Function		Finish	
		10BE/26D/BSP/WSP	03/04/09/10/10B/10BL/14/15/20D/26/32/32D
Single Cyl			
67-7904	Storeroom or Closet		
67-7937	Classroom	\$717.00	\$741.00
67-7955	Office or Entry		
Single Cyl With Deadbolt			
67-7924	Room Door		
67-7925	Dormitory or Exit		
67-7943	Apartment Corridor	\$732.00	\$756.00
67-7945	Dormitory or Exit		
67-7950	Hotel Guest Lock	\$808.00	\$832.00
Double Cyl No Deadbolt			
67-7916	Apartment or Exit or Public Toilet	\$806.00	\$830.00
67-7938	Classroom Security Intruder		
Double Cyl With Deadbolt			
67-7926	Store Door	\$822.00	\$846.00
Non Keyed			
67-7915	Passage or Closet	\$492.00	\$516.00
67-7965	Privacy Bedroom or Bath (Latch)	\$625.00	\$649.00
67-7966	Privacy Bedroom or Bath (Deadbolt)	\$662.00	\$686.00
67-7993	Single Dummy Trim	\$192.00	\$204.00
67-7994	Double Dummy Trim	\$383.00	\$407.00
67-7995	Single Dummy Trim w/Lockbody	\$284.00	\$296.00

ML-152 MORTISE LOCKS

SARGENT®

ASSA ABLOY

OPTIONS

USA & Canada Prices Effective May 1, 2021

Options	Description	Price
1▲	7900 Line with 1-1/16" wide front for 1-3/8" doors.	\$62.00
10▲	SARGENT Signature Key System	\$63.00 / cyl.
11†▲	SARGENT XC Key System (not available with 10, 22, SC, SE options)	No addition
1160	SARGENT XC Large Format Interchangeable Plastic Disposable Construction Core	No addition
1163	SARGENT XC Large Format Interchangeable Core Cylinder - Includes masterkeying charges	\$83.00
1164	SARGENT XC Large Format Interchangeable Construction Core Cylinder	\$83.00
1170	Small Format interchangeable disposable construction core - to accept 7 Pin XC permanent core	No addition
11727P	Small Format interchangeable keyed construction core - to accept 7 Pin XC permanent core	\$75.00
11737P	Small Format interchangeable core - to accept 7 pin XC permanent core	\$75.00 / cyl.
21▲†	SARGENT Construction Key System (lost ball) Standard on all new systems established since 5/1/96	\$16.00 / cyl.
22▲†	SARGENT Construction Key System (split key) To be used on pre-established split key systems only	\$32.00 / cyl.
31	Thick Doors - Extended Lip Required - Specify Length C to E - Cylinders - IMPORTANT- See catalog 7800/8200 option page for cylinder limitations - Below charges DO NOT include additional charges for special cylinder requirements	No addition
	Doors up to 2-1/2" thick - lock centered	No addition
	Doors 2-5/8" to 6" thick OR doors 1-3/4" thick w/max 1" paneling one side. For example: Specify 1-3/4" door with panel (Side) on inside or outside	Non Keyed function \$50.00 Keyed function \$100.00
36	6 Lobe security head screws	\$24.00
37	Spanner head screws	\$17.00
60	SARGENT Large Format Interchangeable Plastic Disposable Construction Core	No addition
63	SARGENT Large Format Interchangeable core cylinder, includes master keying charges	\$83.00 / cyl.
64	SARGENT Large Format Interchangeable Construction Core Cylinder	\$83.00
6573▲†	Small Format 6-Pin Uncombined Core (Refer to CK-12)	\$65.00 / cyl.
65737P▲†	Small Format 7-Pin Uncombined Core (Refer to CK-12)	\$65.00 / cyl.
70▲†	Small Format Interchangeable disposable plastic construction core	No addition
72▲†	Small Format Interchangeable 6-pin construction core (7-pin with 11)	\$75.00
73▲†	Small Format interchangeable core 6-pin Includes MK and GMK keying charges	\$75.00 / cyl
737P▲†	Small Format interchangeable core 7-pin (refer to CK-12 for available keyways) Includes MK and GMK keying charges	\$75.00 / cyl
75	Tactile Warning - Milled Inside Knob	\$78.00
76	Tactile Warning - Milled Outside Knob	\$78.00
77	Tactile Warning - Milled Outside and Inside Knob	\$156.00
F182▲†	SARGENT Keso Security Cylinder – patented – new key systems	\$91.00 / cyl.
F183▲†	SARGENT Keso Security Removable Core Cylinder – patented – new key systems	\$130.00 / cyl.
81▲†	Cylinder to accept Keso (83) and Keso F1(F183) Removable Core – no core provided	No addition
82▲†	SARGENT Keso Security Cylinder (For existing systems only)	\$91.00 / cyl.
83▲†	SARGENT Keso Security Removable Core Cylinder (For existing systems only)	\$130.00 / cyl.
84▲†	SARGENT Keso Security Removable Construction Core Cylinder	See CK-18
85	Tactile Warning - Abrasive Coating on Inside Knob	\$49.00
86	Tactile Warning - Abrasive Coating on Outside Knob	\$49.00
87	Tactile Warning - Abrasive Coating on Outside & Inside Knob	\$98.00
BR	SARGENT Bump Resistant Cylinders (N/A w/10, 22, 30, 60, 63, 64, 70, 72, 73, 737P, KESO, SC, & SE options)	\$25.00 /cyl.
DG1	Patented Degree DG1 Key System	No addition
DG160	Hardware prepared for DG1-6300 Lg. Format IC cores, supplied with temporary plastic construction cores	No addition
DG163	Patented Degree DG1 Large Format Interchangeable Core Cylinder - Includes master keying charges	\$83.00
DG164	Hardware prepared for DG1-6300 Lg. Format IC cores, supplied with temporary keyed construction cores	\$83.00
DG2	Patented Degree DG2 Key System incorporating a locking sidebar	\$63.00/cyl.
DG260	Hardware prepared for DG2-6300 Lg. Format IC cores, supplied with temporary plastic construction cores	No addition
DG263	Patented Degree DG2 Large Format Interchangeable Core Cylinder - Includes master keying charges	\$146.00
DG264	Hardware prepared for DG2-6300 Lg. Format IC cores, supplied with temporary keyed construction cores	\$83.00
DG3	Patented Degree DG3 Key System incorporating a locking sidebar and UL437 listed	\$89.00/cyl.
DG360	Hardware prepared for DG3-6300 Lg. Format IC cores, supplied with temporary plastic construction cores	No addition
DG363	Patented Degree DG3 Large Format Interchangeable Core Cylinder - Includes master keying charges	\$172.00
DG364	Hardware prepared for DG3-6300 Lg. Format IC cores, supplied with temporary keyed construction cores	\$83.00
LC	Less Cylinder	-\$96.00/cyl.
OBS	Open Back Strike	\$79.00
SC▲†	Schlage "C" Keyway cylinder, (Number 41 Cylinder Only, 0 bitted)	No addition
SE▲†	Schlage "E" Keyway cylinder, (Number 41 Cylinder Only, 0 bitted)	No addition
SG	MicroShield® – an antimicrobial powder coat finish	\$73.00
WBS	Wrought Box Strike	No addition

NOTES: ▲ Options not available with a standard 50 function lockout cylinder. † Not available with 60, 63, 64 options.

CPC	67-7904 x KW1B x RH x 32D x CPC (Clear Powder Coat) All orders will continue to be handled as a "special" when CPC is ordered.	\$67.00
-----	---	---------

Experience a safer
and more open world

Copyright © 2002-2021 Sargent Manufacturing Company, an ASSA ABLOY Group company. All rights reserved.
Reproduction in whole or in part without the express written permission of Sargent Manufacturing Company is prohibited.
Contact us at: 800-727-5477 or visit www.sargentlock.com. In Canada contact us at: 800-461-3007 or visit www.assaabloydss.ca



Escutcheon: KW1 (Shown) Rose: B (Shown)

Function		Finish	
		10BE/26D/BSP/WSP	03/04/09/10/10B/10BL/14/15/20D/26/32/32D
Single Cyl			
67-7904	Storeroom or Closet		
67-7937	Classroom	\$732.00	\$756.00
67-7955	Office or Entry		
Single Cyl With Deadbolt			
67-7924	Room Door		
67-7925	Dormitory or Exit	\$745.00	\$769.00
67-7943	Apartment Corridor		
67-7945	Dormitory or Exit		
67-7950	Hotel Guest Lock	\$827.00	\$851.00
Double Cyl No Deadbolt			
67-7916	Apartment or Exit or Public Toilet	\$822.00	\$846.00
67-7938	Classroom Security Intruder		
Double Cyl With Deadbolt			
67-7926	Store Door	\$838.00	\$862.00
Non Keyed			
67-7915	Passage or Closet	\$508.00	\$532.00
67-7965	Privacy Bedroom or Bath (Latch)	\$645.00	\$669.00
67-7966	Privacy Bedroom or Bath (Deadbolt)	\$683.00	\$707.00
67-7993	Single Dummy Trim	\$200.00	\$212.00
67-7994	Double Dummy Trim	\$398.00	\$422.00
67-7995	Single Dummy Trim w/Lockbody	\$294.00	\$306.00

ML-154 MORTISE LOCKS

SARGENT®

ASSA ABLOY

OPTIONS

USA & Canada Prices Effective May 1, 2021

Options	Description	Price
1▲	7900 Line with 1-1/16" wide front for 1-3/8" doors.	\$62.00
10▲	SARGENT Signature Key System	\$63.00 / cyl.
11†▲	SARGENT XC Key System (not available with 10, 22, SC, SE options)	No addition
1160	SARGENT XC Large Format Interchangeable Plastic Disposable Construction Core	No addition
1163	SARGENT XC Large Format Interchangeable Core Cylinder - Includes masterkeying charges	\$83.00
1164	SARGENT XC Large Format Interchangeable Construction Core Cylinder	\$83.00
1170	Small Format interchangeable disposable construction core - to accept 7 Pin XC permanent core	No addition
11727P	Small Format interchangeable keyed construction core - to accept 7 Pin XC permanent core	\$75.00
11737P	Small Format interchangeable core - to accept 7 pin XC permanent core	\$75.00 / cyl.
21▲†	SARGENT Construction Key System (lost ball) Standard on all new systems established since 5/1/96	\$16.00 / cyl.
22▲†	SARGENT Construction Key System (split key) To be used on pre-established split key systems only	\$32.00 / cyl.
31	Thick Doors - Extended Lip Required - Specify Length C to E	
	- Cylinders - IMPORTANT- See catalog 7800/8200 option page for cylinder limitations	
	- Below charges DO NOT include additional charges for special cylinder requirements	
	Doors up to 2-1/2" thick - lock centered	No addition
	Doors 2-5/8" to 6" thick OR doors 1-3/4" thick w/max 1" paneling one side.	
	For example: Specify 1-3/4" door with panel (Side) on inside or outside	Non Keyed function \$50.00 Keyed function \$100.00
36	6 Lobe security head screws	\$24.00
37	Spanner head screws	\$17.00
60	SARGENT Large Format Interchangeable Plastic Disposable Construction Core	No addition
63	SARGENT Large Format Interchangeable core cylinder, includes master keying charges	\$83.00 / cyl.
64	SARGENT Large Format Interchangeable Construction Core Cylinder	\$83.00
6573▲†	Small Format 6-Pin Uncombined Core (Refer to CK-12)	\$65.00 / cyl.
65737P▲†	Small Format 7-Pin Uncombined Core (Refer to CK-12)	\$65.00 / cyl.
70▲†	Small Format Interchangeable disposable plastic construction core	No addition
72▲†	Small Format Interchangeable 6-pin construction core (7-pin with 11)	\$75.00
73▲†	Small Format interchangeable core 6-pin Includes MK and GMK keying charges	\$75.00 / cyl
737P▲†	Small Format interchangeable core 7-pin (refer to CK-12 for available keyways) Includes MK and GMK keying charges	\$75.00 / cyl
75	Tactile Warning - Milled Inside Knob	\$78.00
76	Tactile Warning - Milled Outside Knob	\$78.00
77	Tactile Warning - Milled Outside and Inside Knob	\$156.00
F182▲†	SARGENT Keso Security Cylinder – patented – new key systems	\$91.00 / cyl.
F183▲†	SARGENT Keso Security Removable Core Cylinder – patented – new key systems	\$130.00 / cyl.
81▲†	Cylinder to accept Keso (83) and Keso F1(F183) Removable Core – no core provided	No addition
82▲†	SARGENT Keso Security Cylinder (For existing systems only)	\$91.00 / cyl.
83▲†	SARGENT Keso Security Removable Core Cylinder (For existing systems only)	\$130.00 / cyl.
84▲†	SARGENT Keso Security Removable Construction Core Cylinder	See CK-18
85	Tactile Warning - Abrasive Coating on Inside Knob	\$49.00
86	Tactile Warning - Abrasive Coating on Outside Knob	\$49.00
87	Tactile Warning - Abrasive Coating on Outside & Inside Knob	\$98.00
BR	SARGENT Bump Resistant Cylinders (N/A w/10, 22, 30, 60, 63, 64, 70, 72, 73, 737P, KESO, SC, & SE options)	\$25.00 /cyl.
DG1	Patented Degree DG1 Key System	No addition
DG160	Hardware prepared for DG1-6300 Lg. Format IC cores, supplied with temporary plastic construction cores	No addition
DG163	Patented Degree DG1 Large Format Interchangeable Core Cylinder - Includes master keying charges	\$83.00
DG164	Hardware prepared for DG1-6300 Lg. Format IC cores, supplied with temporary keyed construction cores	\$83.00
DG2	Patented Degree DG2 Key System incorporating a locking sidebar	\$63.00/cyl.
DG260	Hardware prepared for DG2-6300 Lg. Format IC cores, supplied with temporary plastic construction cores	No addition
DG263	Patented Degree DG2 Large Format Interchangeable Core Cylinder - Includes master keying charges	\$146.00
DG264	Hardware prepared for DG2-6300 Lg. Format IC cores, supplied with temporary keyed construction cores	\$83.00
DG3	Patented Degree DG3 Key System incorporating a locking sidebar and UL437 listed	\$89.00/cyl.
DG360	Hardware prepared for DG3-6300 Lg. Format IC cores, supplied with temporary plastic construction cores	No addition
DG363	Patented Degree DG3 Large Format Interchangeable Core Cylinder - Includes master keying charges	\$172.00
DG364	Hardware prepared for DG3-6300 Lg. Format IC cores, supplied with temporary keyed construction cores	\$83.00
LC	Less Cylinder	-\$96.00/cyl.
OBS	Open Back Strike	\$79.00
SC▲†	Schlage "C" Keyway cylinder, (Number 41 Cylinder Only, 0 bitted)	No addition
SE▲†	Schlage "E" Keyway cylinder, (Number 41 Cylinder Only, 0 bitted)	No addition
SG	MicroShield® – an antimicrobial powder coat finish	\$73.00
WBS	Wrought Box Strike	No addition

NOTES: ▲ Options not available with a standard 50 function lockout cylinder. † Not available with 60, 63, 64 options.

CPC	67-7904 x WTB x RH x 32D x CPC (Clear Powder Coat) All orders will continue to be handled as a "special" when CPC is ordered.	\$67.00
-----	--	---------

Experience a safer
and more open world

Copyright © 2002-2021 Sargent Manufacturing Company, an ASSA ABLOY Group company. All rights reserved.
Reproduction in whole or in part without the express written permission of Sargent Manufacturing Company is prohibited.
Contact us at: 800-727-5477 or visit www.sargentlock.com. In Canada contact us at: 800-461-3007 or visit www.assaabloydss.ca



WTB

Escutcheon: WT (Shown) Rose: B (Shown)

Function		Finish	
		10BE/26D/BSP/WSP	03/04/09/10/10B/10BL/14/15/20D/26/32/32D
Single Cyl			
67-7904	Storeroom or Closet		
67-7937	Classroom	\$723.00	\$747.00
67-7955	Office or Entry		
Single Cyl With Deadbolt			
67-7924	Room Door		
67-7925	Dormitory or Exit		
67-7943	Apartment Corridor	\$735.00	\$759.00
67-7945	Dormitory or Exit		
67-7950	Hotel Guest Lock	\$822.00	\$846.00
Double Cyl No Deadbolt			
67-7916	Apartment or Exit or Public Toilet		
67-7938	Classroom Security Intruder	\$814.00	\$838.00
Double Cyl With Deadbolt			
67-7926	Store Door	\$827.00	\$851.00
Non Keyed			
67-7915	Passage or Closet	\$499.00	\$523.00
67-7965	Privacy Bedroom or Bath (Latch)	\$634.00	\$658.00
67-7966	Privacy Bedroom or Bath (Deadbolt)	\$678.00	\$702.00
67-7993	Single Dummy Trim	\$194.00	\$206.00
67-7994	Double Dummy Trim	\$393.00	\$417.00
67-7995	Single Dummy Trim w/Lockbody	\$289.00	\$301.00

ML-156 MORTISE LOCKS

SARGENT®

7900 LOCKBODIES

ASSA ABLOY

USA & Canada Prices Effective May 1, 2021

7900 Lock Bodies Only		
Function		
Single Cyl	Description	All Finishes
04	Storeroom or Closet	
37	Classroom	\$439.00
55	Office or Entry	
Single Cyl With Deadbolt		
24	Room Door	
25	Dormitory or Exit	
43	Apartment Corridor	\$450.00
45	Dormitory or Exit	
50	Hotel Guest Lock	
Double Cyl No Deadbolt		
16	Apartment or Exit or Public Toilet	\$439.00
38	Classroom Security Intruder	
Double Cyl With Deadbolt		
26	Store Door	\$450.00
Electro Mechanical Single Cyl – Specify 12V or 24V		
70-12V / 70-24V	Fail Safe	\$680.00
71-12V / 71-24V	Fail Secure	
Electro Mechanical Double Cyl – Specify 12V or 24V		
72-12V / 72-24V	Fail Safe	\$680.00
73-12V / 72-24V	Fail Secure	
Non Keyed		
15	Passage or Closet	\$265.00
65	Privacy Bedroom or Bath (Latch)	\$355.00
66	Privacy Bedroom or Bath (Deadbolt)	\$450.00
95	Single Dummy Trim w/Lockbody	\$265.00

NOTE: Cylinder and trim not included. Outside front, strike and screwpack are included.

Lockbodies with options 1, 68, 69, RX, or any combination, please consult the factory for correct part number and price.

GENERAL INFORMATION 9200 HIGH SECURITY MORTISE M9200 HIGH SECURITY MORTISE

USA & Canada Prices Effective May 1, 2021

How to Order		
Step	Description	Example
Quantity	Each	10 Ea.
Option	Consult catalog for options available	10 Ea. 3-M-
Product Series	9200 Levers	10 Ea. 3-M-92
Function	Consult catalog for functions available	10 Ea. 3-M-9205
Trim	Consult catalog for trims available	10 Ea. 3-M-9205 SNJ
Finish	Consult catalog for finishes available	10 Ea. 3-M-9205 SNJ US26D
Hand	Consult catalog for handing requirements	10 Ea. 3-M-9205 SNJ US26D RH
Options	Consult factory for options available	10 Ea. 3-M-9205SNJ US26D RH x 1-3/8" LIP STRIKE
When ordering split finishes specify outside finish first		10 Ea. 3-M-9205 SNJ US3 x US26D RH

To price split trim/finish, add the price of each trim/finish and divide by two (2).

Locksets in combinations not listed should be figured by adding together the prices of the component parts.

If by any method of figuring, lower prices can be obtained than set prices shown, set prices will prevail.

It is not permissible to take full deduction for omission of a component from a lockset.

Prices are for 1-3/4" door. For other door thicknesses not listed herein, please consult factory.

ANSI Finish and Function Comparison					
Function			Finish		
SARGENT	ANSI	A.S.T.M. #	SARGENT	ANSI	Description
15	F01	401	US4	606	Satin Brass, Clear Coated
05, 55	F04	404	US26D	626	Satin Chrome
37	F05	405	US32D	630	Satin Stainless Steel
04	F07	407			
16	F09	409			
45	F12				
25	F13	413MOD.			
26	F14	414-2			
50	F15MOD.				
22	F16	416			
21	F17	417			
20	F18	418			
66	F19				
24	F21	421MOD.			
43	F20				
65	F22	419MOD.			
03	F29				
17	F30	433-2			
38	F32				
39	F33				
40	F34				

ML-158 MORTISE LOCKS

SARGENT®

OPTIONS-9200

ASSA ABLOY

USA & Canada Prices Effective May 1, 2021

Options	Description	Price
3	Stainless Steel Hubs	\$69.00
10▲	SARGENT Signature Key Systems	\$63.00 / cyl.
11†	SARGENT XC Key System (not available with 10, 22, SC, SE options)	No addition
1160	SARGENT XC Large Format Interchangeable Plastic Disposable Construction Core	No addition
1163	SARGENT XC Large Format Interchangeable Core Cylinder - Includes masterkeying charges	\$83.00
1164	SARGENT XC Large Format Interchangeable Construction Core Cylinder	\$83.00
1170	Small Format interchangeable disposable construction core - to accept 7 Pin XC permanent core	No addition
11727P	Small Format interchangeable keyed construction core - to accept 7 Pin XC permanent core	\$75.00
11737P	Small Format interchangeable core - to accept 7 pin XC permanent core	\$75.00 / cyl.
21▲†	SARGENT Construction Key System (lost ball) Standard on all new systems established since 5/1/96	\$16.00 / cyl.
22▲†	SARGENT Construction Key System (split key) To be used on pre-established split key systems only	\$32.00 / cyl.
23	Flat Lip ANSI 4-7/8" Strike	No addition
31	Thick Doors - Extended Lip Required - Specify Length C to E - Cylinders - IMPORTANT- See catalog 7800/8200 option page for cylinder limitations - Below charges DO NOT include additional charges for special cylinder requirements Doors up to 2-1/2" thick - lock centered Doors 2-5/8" to 6" thick OR doors 1-3/4" thick w/max 1" paneling one side. For example: Specify 1-3/4" door with panel (Side) on inside or outside	No addition Non Keyed function \$50.00 Keyed function \$100.00
36	6 Lobe security head screw	\$24.00
60*	SARGENT Large Format Interchangeable Plastic Disposable Construction Core	No addition
63*	SARGENT Large Format Interchangeable core cylinder, includes master keying charges	\$83.00 / cyl.
64*	SARGENT Large Format Interchangeable Construction Core Cylinder	\$83.00
6573*▲†	Small Format 6-Pin Uncombined Core (Refer to CK-12)	\$65.00 / cyl.
65737P*▲†	Small Format 7-Pin Uncombined Core (Refer to CK-12)	\$65.00 / cyl.
68	Lever Outside x Knob Inside – specify K or D Knob	Defaults to higher priced lock
69	Knob Outside x Lever Inside – specify K or D Knob	Defaults to higher priced lock
70*▲†	Small Format Interchangeable disposable plastic construction core	No addition
72*▲†	Small Format Interchangeable 6-pin construction core (7-pin with 11)	\$75.00
73*▲†	Small Format interchangeable core 6-pin Includes MK and GMK keying charges	\$75.00 / cyl.
737P*▲†	Small Format interchangeable core 7-pin (refer to CK-12 for available keyways) Includes MK and GMK keying charges	\$75.00 / cyl.
75	Tactile Warning - Milled Inside Lever	\$78.00
76	Tactile Warning - Milled Outside Lever	\$78.00
77	Tactile Warning - Milled Outside and Inside Lever	\$156.00
81▲†	Cylinder to accept Keso (83) and Keso F1 (F183) removable core – no core provided	No addition
F182†	SARGENT Keso Security Cylinder – patented – new key systems	\$91.00
F183▲†	SARGENT Keso Security Removable Core Cylinder – patented – new key systems	\$130.00
82†	SARGENT Keso Security Cylinder (For existing systems only)	\$91.00
83▲†	SARGENT Keso Security Removable Core Cylinder (For existing systems only)	\$130.00
84▲†	SARGENT Keso Security Removable Construction Core Cylinder	See CK-18
85	Tactile Warning - Abrasive Coating on Inside Lever	\$49.00
86	Tactile Warning - Abrasive Coating on Outside Lever	\$49.00
87	Tactile Warning - Abrasive Coating on Outside & Inside Lever	\$98.00
AV	Anti Vandal Pull Trim (available in 32D finish) – refer to ML-65 for Trim only (Not available with 9270, 9271, 9272, 9273 functions)	\$229.00
BR	SARGENT Bump Resistant Cylinders (N/A w/10, 22, 30, 60, 63, 64, 70, 72, 73, 737P, KESO, SC, & SE options)	\$25.00 / cyl.
DG1	Patented Degree DG1 Key System	No addition
DG160	Hardware prepared for DG1-6300 Lg. Format IC cores, supplied with temporary plastic construction cores	No addition
DG163	Patented Degree DG1 Large Format Interchangeable Core Cylinder - Includes master keying charges	\$83.00
DG164	Hardware prepared for DG1-6300 Lg. Format IC cores, supplied with temporary keyed construction cores	\$83.00
DG2	Patented Degree DG2 Key System incorporating a locking sidebar	\$63.00/cyl.
DG260	Hardware prepared for DG2-6300 Lg. Format IC cores, supplied with temporary plastic construction cores	No addition
DG263	Patented Degree DG2 Large Format Interchangeable Core Cylinder - Includes master keying charges	\$146.00
DG264	Hardware prepared for DG2-6300 Lg. Format IC cores, supplied with temporary keyed construction cores	\$83.00
DG3	Patented Degree DG3 Key System incorporating a locking sidebar and UL437 listed	\$89.00/cyl.
DG360	Hardware prepared for DG3-6300 Lg. Format IC cores, supplied with temporary plastic construction cores	No addition
DG363	Patented Degree DG3 Large Format Interchangeable Core Cylinder - Includes master keying charges	\$172.00
DG364	Hardware prepared for DG3-6300 Lg. Format IC cores, supplied with temporary keyed construction cores	\$83.00
LC	Less Cylinder	-\$96.00/cyl.
OBS	Open Back Strike	\$79.00
M▲†	Mogul Lock - Mogul Cylinder to be ordered separate (Cylinder not included and do not receive Less Cylinder deduct	\$427.00
SG	MicroShield® – an antimicrobial powder coat finish	\$73.00
WBS	Wrought Box Strike	No addition

NOTES: ▲Not available with 50 function lockout cylinder. *Does NOT meet security Grade 1 requirements.
**Not available with M- option. †Not available with 60, 63, 64 options.

CPC	Clear Powder Coat over 26D/32D – 9205 x LNB x 32D x CPC All orders will continue to be handled as a “special” when CPC is ordered.	\$67.00
-----	---	---------

Experience a safer
and more open world

Copyright © 2002-2021 Sargent Manufacturing Company, an ASSA ABLOY Group company. All rights reserved.
Reproduction in whole or in part without the express written permission of Sargent Manufacturing Company is prohibited.
Contact us at: 800-727-5477 or visit www.sargentlock.com. In Canada contact us at: 800-461-3007 or visit www.assaabloydss.ca



LNB

Rose: LN (Shown), L • Levers: B (Shown), L, J, P

Function	Finish	
	04/26D	32D
Single Cylinder		
9204 Storeroom		
9205 Office		
9206 Service	\$1,464.00	\$1,533.00
9237 Classroom		
9255 Office		
Single Cylinder with Deadbolt		
9224 Storeroom	\$1,507.00	\$1,580.00
9225 Dormitory		
9235 Storeroom		
Single Cylinder with Deadbolt		
9243 Entrance	\$1,533.00	\$1,603.00
9245 Entrance		
Single Cylinder with Deadbolt		
* 9250 Hotel	\$1,561.00	\$1,633.00
Double Cylinder		
* 9216 Public Entrance		
9217 Asylum	\$1,592.00	\$1,661.00
9238 Classroom Security		
* 9259 Double Locking		
Double Cylinder with Deadbolt		
9226 Storeroom		
9239 Classroom Security		
9240 Classroom Security	\$1,649.00	\$1,720.00
* 9241 Classroom Security		
* 9249 Security Deadbolt		
Electro Mechanical Single Cyl. – Specify 12V or 24V		
* 9270-12V / 9270-24V Fail Safe	\$1,793.00	\$1,864.00
* 9271-12V / 9271-24V Fail Secure		
Electro Mechanical Double Cyl. – Specify 12V or 24V		
* 9272-12V / 9272-24V Fail Safe	\$1,882.00	\$1,951.00
* 9273-12V / 9273-24V Fail Secure		
Keyed		
* 9215 Passage	\$1,201.00	\$1,274.00
* 9265 Privacy	\$1,396.00	\$1,467.00
Non Keyed with Deadbolt		
* 9266 Privacy	\$1,485.00	\$1,557.00

* Not available with Mogul Cylinder (M-option)

ML-160 MORTISE LOCKS

SARGENT®

ASSA ABLOY

OPTIONS-9200

USA & Canada Prices Effective May 1, 2021

Options	Description	Price
3	Stainless Steel Hubs	\$69.00
10▲	SARGENT Signature Key Systems	\$63.00 / cyl.
11**†	SARGENT XC Key System (not available with 10, 22, SC, SE options)	No addition
1160	SARGENT XC Large Format Interchangeable Plastic Disposable Construction Core	No addition
1163	SARGENT XC Large Format Interchangeable Core Cylinder - Includes masterkeying charges	\$83.00
1164	SARGENT XC Large Format Interchangeable Construction Core Cylinder	\$83.00
1170	Small Format interchangeable disposable construction core - to accept 7 Pin XC permanent core	No addition
11727P	Small Format interchangeable keyed construction core - to accept 7 Pin XC permanent core	\$75.00
11737P	Small Format interchangeable core - to accept 7 pin XC permanent core	\$75.00 / cyl.
21▲†	SARGENT Construction Key System (lost ball) Standard on all new systems established since 5/1/96	\$16.00 / cyl.
22▲†	SARGENT Construction Key System (split key) To be used on pre-established split key systems only	\$32.00 / cyl.
23	Flat Lip ANSI 4-7/8" Strike	No addition
31	Thick Doors - Extended Lip Required - Specify Length C to E - Cylinders - IMPORTANT- See catalog 7800/8200 option page for cylinder limitations - Below charges DO NOT include additional charges for special cylinder requirements	No addition
	Doors up to 2-1/2" thick - lock centered	No addition
	Doors 2-5/8" to 6" thick OR doors 1-3/4" thick w/max 1" paneling one side. For example: Specify 1-3/4" door with panel (Side) on inside or outside	Non Keyed function \$50.00 Keyed function \$100.00
36	6 Lobe security head screw	\$24.00
60*	SARGENT Large Format Interchangeable Plastic Disposable Construction Core	No addition
63*	SARGENT Large Format Interchangeable core cylinder, includes master keying charges	\$83.00 / cyl.
64*	SARGENT Large Format Interchangeable Construction Core Cylinder	\$83.00
6573*▲†	S Small Format 6-Pin Uncombined Core (Refer to CK-12)	\$65.00 / cyl.
65737P*▲†	Small Format 7-Pin Uncombined Core (Refer to CK-12)	\$65.00 / cyl.
68	Lever Outside x Knob Inside – specify K or D Knob	Defaults to higher priced lock
69	Knob Outside x Lever Inside – specify K or D Knob	Defaults to higher priced lock
70*▲†	Small Format Interchangeable disposable plastic construction core	No addition
72*▲†	Small Format Interchangeable 6-pin construction core (7-pin with 11)	\$75.00
73*▲†	Small Format interchangeable core 6-pin Includes MK and GMK keying charges	\$75.00 / cyl.
737P*▲†	Small Format interchangeable core 7-pin (refer to CK-12 for available keyways) Includes MK and GMK keying charges	\$75.00 / cyl.
75	Tactile Warning - Milled Inside Lever	\$78.00
76	Tactile Warning - Milled Outside Lever	\$78.00
77	Tactile Warning - Milled Outside and Inside Lever	\$156.00
81▲†	Cylinder to accept Keso (83) and Keso F1 (F183) removable core – no core provided	No addition
F182†	SARGENT Keso Security Cylinder – patented – new key systems	\$91.00
F183▲†	SARGENT Keso Security Removable Core Cylinder – patented – new key systems	\$130.00
82†	SARGENT Keso Security Cylinder (For existing systems only)	\$91.00
83▲†	SARGENT Keso Security Removable Core Cylinder (For existing systems only)	\$130.00
84▲†	SARGENT Keso Security Removable Construction Core Cylinder	See CK-18
85	Tactile Warning - Abrasive Coating on Inside Lever	\$49.00
86	Tactile Warning - Abrasive Coating on Outside Lever	\$49.00
87	Tactile Warning - Abrasive Coating on Outside & Inside Lever	\$98.00
AV	Anti Vandal Pull Trim (available in 32D finish), (Not available with 9270, 9271, 9272, 9273 functions)	\$229.00
BR	SARGENT Bump Resistant Cylinders (N/A w/10, 22, 30, 60, 63, 64, 70, 72, 73, 737P, KESO, SC, & SE options)	\$25.00 /cyl.
DG1	Patented Degree DG1 Key System	No addition
DG160	Hardware prepared for DG1-6300 Lg. Format IC cores, supplied with temporary plastic construction cores	No addition
DG163	Patented Degree DG1 Large Format Interchangeable Core Cylinder - Includes master keying charges	\$83.00
DG164	Hardware prepared for DG1-6300 Lg. Format IC cores, supplied with temporary keyed construction cores	\$83.00
DG2	Patented Degree DG2 Key System incorporating a locking sidebar	\$63.00/cyl.
DG260	Hardware prepared for DG2-6300 Lg. Format IC cores, supplied with temporary plastic construction cores	No addition
DG263	Patented Degree DG2 Large Format Interchangeable Core Cylinder - Includes master keying charges	\$146.00
DG264	Hardware prepared for DG2-6300 Lg. Format IC cores, supplied with temporary keyed construction cores	\$83.00
DG3	Patented Degree DG3 Key System incorporating a locking sidebar and UL437 listed	\$89.00/cyl.
DG360	Hardware prepared for DG3-6300 Lg. Format IC cores, supplied with temporary plastic construction cores	No addition
DG363	Patented Degree DG3 Large Format Interchangeable Core Cylinder - Includes master keying charges	\$172.00
DG364	Hardware prepared for DG3-6300 Lg. Format IC cores, supplied with temporary keyed construction cores	\$83.00
LC	Less Cylinder	-\$96.00/cyl.
M▲†	Mogul Lock - Mogul Cylinder to be ordered separate (Cylinder not included and do not receive Less Cylinder deduct	\$427.00
OBS	Open Back Strike	\$79.00
SG	MicroShield® – an antimicrobial powder coat finish	\$73.00
WBS	Wrought Box Strike	No addition

▲ Not available with 50 function lockout cylinder.

* Does NOT meet security Grade 1 requirements.

** Not available with M- option.

† Not available with 60, 63, 64 options

CPC Clear Powder Coat over 26D/32D – 9205 x SNB x 32D x CPC \$67.00
All orders will continue to be handled as a "special" when CPC is ordered.

Experience a safer
and more open world

Copyright © 2002-2021 Sargent Manufacturing Company, an ASSA ABLOY Group company. All rights reserved.
Reproduction in whole or in part without the express written permission of Sargent Manufacturing Company is prohibited.
Contact us at: 800-727-5477 or visit www.sargentlock.com. In Canada contact us at: 800-461-3007 or visit www.assaabloydss.ca



USA & Canada Prices Effective May 1, 2021

Rose: SN, SL (Shown) • Levers: B, L (Shown), J, P

(Provided with Knurled Security Trim and Torx® Security Screws)

Function		Finish	
		04/26D	32D
Single Cylinder			
9204	Storeroom		
9205	Office		
9206	Service	\$1,596.00	\$1,671.00
9237	Classroom		
9255	Office		
Single Cylinder with Deadbolt			
9224	Storeroom	\$1,646.00	\$1,715.00
9225	Dormitory		
9235	Storeroom		
Single Cylinder with Deadbolt			
9243	Entrance	\$1,671.00	\$1,735.00
9245	Entrance		
Single Cylinder with Deadbolt			
* 9250	Hotel	\$1,694.00	\$1,765.00
Double Cylinder			
* 9216	Public Entrance		
9217	Asylum	\$1,731.00	\$1,799.00
9238	Classroom Security		
* 9259	Double Locking		
Double Cylinder with Deadbolt			
9226	Storeroom		
9239	Classroom Security		
9240	Classroom Security	\$1,782.00	\$1,857.00
* 9241	Classroom Security		
* 9249	Security Deadbolt		
Electro Mechanical Single Cyl. – Specify 12V or 24V			
* 9270-12V / 9270-24V Fail Safe			
* 9271-12V / 9271-24V Fail Secure		\$1,927.00	\$2,001.00
Electro Mechanical Double Cyl. – Specify 12V or 24V			
* 9272-12V / 9272-24V Fail Safe			
* 9273-12V / 9273-24V Fail Secure		\$2,012.00	\$2,089.00
Non Keyed			
* 9215	Passage	\$1,338.00	\$1,411.00
* 9265	Privacy	\$1,533.00	\$1,603.00
Keyed with Deadbolt			
* 9266	Privacy	\$1,622.00	\$1,691.00

* Not available with Mogul Cylinder (M-option)

ML-162 MORTISE LOCKS

SARGENT®

ASSA ABLOY

OPTIONS

USA & Canada Prices Effective May 1, 2021

Options	Description	Price
3	Stainless Steel Hubs	\$69.00
10▲	SARGENT Signature Key Systems	\$63.00 / cyl.
11†	SARGENT XC Key System (not available with 10, 22, SC, SE options)	No addition
1160	SARGENT XC Large Format Interchangeable Plastic Disposable Construction Core	No addition
1163	SARGENT XC Large Format Interchangeable Core Cylinder - Includes masterkeying charges	\$83.00
1164	SARGENT XC Large Format Interchangeable Construction Core Cylinder	\$83.00
1170	Small Format interchangeable disposable construction core - to accept 7 Pin XC permanent core	No addition
11727P	Small Format interchangeable keyed construction core - to accept 7 Pin XC permanent core	\$75.00
11737P	Small Format interchangeable core - to accept 7 pin XC permanent core	\$75.00 / cyl.
21†▲	SARGENT Construction Key System (lost ball) Standard on all new systems established since 5/1/96	\$16.00 / cyl.
22†▲	SARGENT Construction Key System (split key) To be used on pre-established split key systems only	\$32.00 / cyl.
23	Flat Lip ANSI 4-7/8" Strike	No addition
31	Thick Doors - Extended Lip Required - Specify Length C to E - Cylinders - IMPORTANT- See catalog 7800/8200 option page for cylinder limitations - Below charges DO NOT include additional charges for special cylinder requirements Doors up to 2-1/2" thick - lock centered Doors 2-5/8" to 6" thick OR doors 1-3/4" thick w/max 1" paneling one side. For example: Specify 1-3/4" door with panel (Side) on inside or outside	No addition Non Keyed function \$50.00 Keyed function \$100.00
36	6 Lobe security head screw	\$24.00
60*▲	SARGENT Large Format Interchangeable Plastic Disposable Construction Core	No addition
63*▲	SARGENT Large Format Interchangeable core cylinder, includes master keying charges	\$83.00 / cyl.
64*▲	SARGENT Large Format Interchangeable Construction Core Cylinder	\$83.00
6573*†▲	Small Format 6-Pin Uncombined Core (Refer to CK-12)	\$65.00 / cyl.
65737P*†▲	Small Format 7-Pin Uncombined Core (Refer to CK-12)	\$65.00 / cyl.
70*†▲	Small Format interchangeable disposable plastic construction core	No addition
72*†▲	Small Format Interchangeable 6-pin construction core (7-pin with 11)	\$75.00
73*†▲	Small Format interchangeable core 6-pin Includes MK and GMK keying charges	\$75.00 / cyl.
737P*†▲	Small Format interchangeable core 7-pin (refer to CK-12 for available keyways) Includes MK and GMK keying charges	\$75.00 / cyl.
75	Tactile Warning - Milled Inside Lever	\$78.00
76	Tactile Warning - Milled Outside Lever	\$78.00
77	Tactile Warning - Milled Outside and Inside Lever	\$156.00
81▲†	Cylinder to accept Keso (83) and Keso F1 (F183) removable core – no core provided	No addition
F182†	SARGENT Keso Security Cylinder – patented – new key systems	\$91.00
F183▲†	SARGENT Keso Security Removable Core Cylinder – patented – new key systems	\$130.00
82†	SARGENT Keso Security Cylinder (For existing systems only)	\$91.00
83▲†	SARGENT Keso Security Removable Core Cylinder (For existing systems only)	\$130.00
84▲†	SARGENT Keso Security Removable Construction Core Cylinder	See CK-18
85	Tactile Warning - Abrasive coating on inside lever	\$49.00
86	Tactile Warning - Abrasive coating on outside lever	\$49.00
87	Tactile Warning - Abrasive coating on both levers	\$98.00
BR	SARGENT Bump Resistant Cylinders (N/A w/10, 22, 30, 60, 63, 64, 70, 72, 73, 737P, KESO, SC, & SE options)	\$25.00 /cyl.
DG1	Patented Degree DG1 Key System	No addition
DG160	Hardware prepared for DG1-6300 Lg. Format IC cores, supplied with temporary plastic construction cores	No addition
DG163	Patented Degree DG1 Large Format Interchangeable Core Cylinder - Includes master keying charges	\$83.00
DG164	Hardware prepared for DG1-6300 Lg. Format IC cores, supplied with temporary keyed construction cores	\$83.00
DG2	Patented Degree DG2 Key System incorporating a locking sidebar	\$63.00/cyl.
DG260	Hardware prepared for DG2-6300 Lg. Format IC cores, supplied with temporary plastic construction cores	No addition
DG263	Patented Degree DG2 Large Format Interchangeable Core Cylinder - Includes master keying charges	\$146.00
DG264	Hardware prepared for DG2-6300 Lg. Format IC cores, supplied with temporary keyed construction cores	\$83.00
DG3	Patented Degree DG3 Key System incorporating a locking sidebar and UL437 listed	\$89.00/cyl.
DG360	Hardware prepared for DG3-6300 Lg. Format IC cores, supplied with temporary plastic construction cores	No addition
DG363	Patented Degree DG3 Large Format Interchangeable Core Cylinder - Includes master keying charges	\$172.00
DG364	Hardware prepared for DG3-6300 Lg. Format IC cores, supplied with temporary keyed construction cores	\$83.00
LC	Less Cylinder	-\$96.00/cyl.
OBS	Open Back Strike	\$79.00
SG	MicroShield® – an antimicrobial powder coat finish	\$73.00
WBS	Wrought Box Strike	No addition

▲ Not available with 50 function lockout cylinder.

* Does NOT meet security Grade 1 requirements.

† Not available with 60, 63, 64 options

CPC Clear Powder Coat over 26D/32D – 9205 x LE3B x 32D x CPC \$67.00
All orders will continue to be handled as a "special" when CPC is ordered.

Experience a safer
and more open world

Copyright © 2002-2021 Sargent Manufacturing Company, an ASSA ABLOY Group company. All rights reserved.
Reproduction in whole or in part without the express written permission of Sargent Manufacturing Company is prohibited.
Contact us at: 800-727-5477 or visit www.sargentlock.com. In Canada contact us at: 800-461-3007 or visit www.assaabloydss.ca

USA & Canada Prices Effective May 1, 2021



Escutcheon: LE3 (Shown), LE4 • Levers: B, L (Shown), J, P

Function		Finish	
		04/26D	32D
Single Cylinder			
9204	Storeroom		
9205	Office		
9206	Service	\$1,615.00	\$1,683.00
9237	Classroom		
9255	Office		
Single Cylinder with Deadbolt			
9224	Storeroom	\$1,661.00	\$1,733.00
9225	Dormitory		
9235	Storeroom		
Single Cylinder with Deadbolt			
9243	Entrance	\$1,683.00	\$1,759.00
9245	Entrance		
Single Cylinder with Deadbolt			
9250	Hotel	\$1,715.00	\$1,782.00
Non Keyed			
9215	Passage	\$1,357.00	\$1,429.00
9265	Privacy	\$1,549.00	\$1,622.00
Non Keyed with Deadbolt			
9266	Privacy	\$1,639.00	\$1,712.00
Electro Mechanical Single Cyl. – Specify 12V or 24V			
9270-12V / 9270-24V	Fail Safe		
9271-12V / 9271-24V	Fail Secure	\$1,948.00	\$2,012.00

ML-164 MORTISE LOCKS

SARGENT®

OPTIONS-9200

ASSA ABLOY

USA & Canada Prices Effective May 1, 2021

Options	Description	Price
3	Stainless Steel Hubs	\$69.00
10▲	SARGENT Signature Key Systems	\$63.00 / cyl.
11	SARGENT XC Key System (not available with 10, 22, SC, SE options)	No addition
21▲	SARGENT Construction Key System (lost ball) Standard on all new systems established since 5/1/96	\$16.00 / cyl.
22▲	SARGENT Construction Key System (split key) To be used on pre-established split key systems only	\$32.00 / cyl.
23	Flat Lip ANSI 4-7/8" Strike	No addition
31	Thick Doors - Extended Lip Required - Specify Length C to E - Cylinders - IMPORTANT- See catalog 7800/8200 option page for cylinder limitations - Below charges DO NOT include additional charges for special cylinder requirements	No addition
	Doors up to 2-1/2" thick - lock centered	No addition
	Doors 2-5/8" to 6" thick OR doors 1-3/4" thick w/max 1" paneling one side. For example: Specify 1-3/4" door with panel (Side) on inside or outside	Non Keyed function \$50.00 Keyed function \$100.00
36	6 Lobe security head screw	\$24.00
68	Lever Outside x Knob Inside (K Knob Only)	Defaults to higher priced lock
69	Knob Outside x Lever Inside (K Knob Only)	Defaults to higher priced lock
75	Tactile Warning - Milled Inside Lever	\$78.00
76	Tactile Warning - Milled Outside Lever	\$78.00
77	Tactile Warning - Milled Outside and Inside Lever	\$156.00
85	Tactile Warning - Abrasive coating on inside lever	\$49.00
86	Tactile Warning - Abrasive coating on outside lever	\$49.00
87	Tactile Warning - Abrasive coating on both levers	\$98.00
BR	SARGENT Bump Resistant Cylinders (N/A w/10, 22, 30, 60, 63, 64, 70, 72, 73, 737P, KESO, SC, & SE options)	\$25.00 /cyl.
LC	Less Cylinder	-\$96.00/cyl.
OBS	Open Back Strike	\$79.00
SG	MicroShield® – an antimicrobial powder coat finish	\$73.00
WBS	Wrought Box Strike	No addition

▲ Not available with 50 function lockout cylinder.

* Does NOT meet security Grade 1 requirements

CPC Clear Powder Coat over 26D/32D – 9205 x LSB x 32D x CPC \$67.00
All orders will continue to be handled as a "special" when CPC is ordered.



Escutcheon: LS (Shown) • Levers: B, L (Shown), J, P

Function		Finish	
		04/26D	32D
aSingle Cylinder			
9204	Storeroom		
9205	Office		
9206	Service		
9237	Classroom	\$2,086.00	\$2,157.00
9255	Office		
Single Cylinder with Deadbolt			
9224	Storeroom	\$2,131.00	\$2,200.00
9225	Dormitory		
9235	Storeroom		
Single Cylinder with Deadbolt			
9243	Entrance	\$2,157.00	\$2,224.00
9245	Entrance		
Single Cylinder with Deadbolt			
9250	Hotel	\$2,183.00	\$2,253.00
Double Cylinder			
9216	Public Entrance		
9217	Asylum	\$2,215.00	\$2,285.00
9238	Classroom Security		
9259	Double Locking		
Double Cylinder with Deadbolt			
9226	Storeroom		
9339	Classroom Security		
9340	Classroom Security	\$2,273.00	\$2,345.00
9341	Classroom Security		
9249	Security Deadbolt		
Non Keyed			
9215	Passage	\$1,827.00	\$1,898.00
9265	Privacy	\$2,017.00	\$2,090.00
Non Keyed with Deadbolt			
9266	Privacy	\$2,107.00	\$2,178.00

ML-166 MORTISE LOCKS

SARGENT®

ASSA ABLOY

OPTIONS-9200

USA & Canada Prices Effective May 1, 2021

Options	Description	Price
3	Stainless Steel Hubs	\$69.00
10▲	SARGENT Signature Key Systems	\$63.00 / cyl.
11**†	SARGENT XC Key System (not available with 10, 22, SC, SE options)	No addition
1160	SARGENT XC Large Format Interchangeable Plastic Disposable Construction Core	No addition
1163	SARGENT XC Large Format Interchangeable Core Cylinder - Includes masterkeying charges	\$83.00
1164	SARGENT XC Large Format Interchangeable Construction Core Cylinder	\$83.00
1170	Small Format interchangeable disposable construction core - to accept 7 Pin XC permanent core	No addition
11727P	Small Format interchangeable keyed construction core - to accept 7 Pin XC permanent core	\$75.00
11737P	Small Format interchangeable core - to accept 7 pin XC permanent core	\$75.00 / cyl.
21▲†	SARGENT Construction Key System (lost ball) Standard on all new systems established since 5/1/96	\$16.00 / cyl.
22▲†	SARGENT Construction Key System (split key) To be used on pre-established split key systems only	\$32.00 / cyl.
23	Flat Lip ANSI 4-7/8" Strike	No addition
31	Thick Doors - Extended Lip Required - Specify Length C to E - Cylinders - IMPORTANT- See catalog 7800/8200 option page for cylinder limitations - Below charges DO NOT include additional charges for special cylinder requirements	No addition
	Doors up to 2-1/2" thick - lock centered	No addition
	Doors 2-5/8" to 6" thick OR doors 1-3/4" thick w/max 1" paneling one side. For example: Specify 1-3/4" door with panel (Side) on inside or outside	Non Keyed function \$50.00 Keyed function \$100.00
36	SARGENT Removable Plastic Disposable Construction Core	\$24.00
60*	SARGENT Large Format Interchangeable Plastic Disposable Construction Core	No addition
63*	SARGENT Large Format Interchangeable core cylinder, includes master keying charges	\$83.00 / cyl.
64*	SARGENT Large Format Interchangeable Construction Core Cylinder	\$83.00
6573*▲†	Small Format 6-Pin Uncombined Core (Refer to CK-12)	\$65.00 / cyl.
65737P*▲†	Small Format 7-Pin Uncombined Core (Refer to CK-12)	\$65.00 / cyl.
67	9200 Knob Outside x Knob Inside	No Add
70*▲†	Small Format Interchangeable disposable plastic construction core	No addition
72*▲†	Small Format Interchangeable 6-pin construction core (7-pin with 11)	\$75.00
73*▲†	Small Format interchangeable core 6-pin Includes MK and GMK keying charges	\$75.00 / cyl.
737P*▲†	Small Format interchangeable core 7-pin (refer to CK-12 for available keyways) Includes MK and GMK keying charges	\$75.00 / cyl.
75	Tactile Warning - Milled Inside Knob	\$78.00
76	Tactile Warning - Milled Outside Knob	\$78.00
77	Tactile Warning - Milled Outside and Inside Knob	\$156.00
81▲†	Cylinder to accept Keso (83) and Keso F1 (F183) removable core – no core provided	No addition
F182†	SARGENT Keso Security Cylinder – patented – new key systems	\$91.00
F183▲†	SARGENT Keso Security Removable Core Cylinder – patented – new key systems	\$130.00
82†	SARGENT Keso Security Cylinder (For existing systems only)	\$91.00
83▲†	SARGENT Keso Security Removable Core Cylinder (For existing systems only)	\$130.00
84▲†	SARGENT Keso Security Removable Construction Core Cylinder	See CK-18
AV	Anti Vandal Pull Trim (available in 32D finish), (Not available with 9270, 9271, 9272, 9273 functions)	\$229.00
BR	SARGENT Bump Resistant Cylinders (N/A w/10, 22, 30, 60, 63, 64, 70, 72, 73, 737P, KESO, SC, & SE options)	\$25.00 /cyl.
DG1	Patented Degree DG1 Key System	No addition
DG160	Hardware prepared for DG1-6300 Lg. Format IC cores, supplied with temporary plastic construction cores	No addition
DG163	Patented Degree DG1 Large Format Interchangeable Core Cylinder - Includes master keying charges	\$83.00
DG164	Hardware prepared for DG1-6300 Lg. Format IC cores, supplied with temporary keyed construction cores	\$83.00
DG2	Patented Degree DG2 Key System incorporating a locking sidebar	\$63.00/cyl.
DG260	Hardware prepared for DG2-6300 Lg. Format IC cores, supplied with temporary plastic construction cores	No addition
DG263	Patented Degree DG2 Large Format Interchangeable Core Cylinder - Includes master keying charges	\$146.00
DG264	Hardware prepared for DG2-6300 Lg. Format IC cores, supplied with temporary keyed construction cores	\$83.00
DG3	Patented Degree DG3 Key System incorporating a locking sidebar and UL437 listed	\$89.00/cyl.
DG360	Hardware prepared for DG3-6300 Lg. Format IC cores, supplied with temporary plastic construction cores	No addition
DG363	Patented Degree DG3 Large Format Interchangeable Core Cylinder - Includes master keying charges	\$172.00
DG364	Hardware prepared for DG3-6300 Lg. Format IC cores, supplied with temporary keyed construction cores	\$83.00
LC	Less Cylinder	-\$96.00/cyl.
M▲†	Mogul Lock - Mogul Cylinder to be ordered separate (Cylinder not included and do not receive Less Cylinder deduct	\$427.00
OBS	Open Back Strike	\$79.00
SG	MicroShield® – an antimicrobial powder coat finish	\$73.00
WBS	Wrought Box Strike	No addition

- ▲ Not available with 50 function lockout cylinder.
- * Does NOT meet security Grade 1 requirements.
- ** Not available with M- option.
- † Not available with 60, 63, 64 options

CPC Clear Powder Coat over 26D/32D – 9205 x SNB x 32D x CPC \$67.00
All orders will continue to be handled as a "special" when CPC is ordered.

Experience a safer
and more open world

Copyright © 2002-2021 Sargent Manufacturing Company, an ASSA ABLOY Group company. All rights reserved.
Reproduction in whole or in part without the express written permission of Sargent Manufacturing Company is prohibited.
Contact us at: 800-727-5477 or visit www.sargentlock.com. In Canada contact us at: 800-461-3007 or visit www.assaabloydss.ca



SLK

USA & Canada Prices Effective May 1, 2021

Rose: SL (Shown), SN • Knob: K (Shown)

Note: Must be ordered with 67 option.

(Provided with Knurled Security Trim and Torx® Security Screws)

Function	Finish	
	04/26D	32D
Option Single Cylinder		
67-9204 Storeroom		
67-9205 Office		
67-9206 Service	\$1,862.00	\$1,930.00
67-9237 Classroom		
67-9255 Office		
Single Cylinder with Deadbolt		
67-9224 Storeroom	\$1,906.00	\$1,978.00
67-9225 Dormitory		
67-9235 Storeroom		
Single Cylinder with Deadbolt		
67-9243 Entrance	\$1,930.00	\$2,002.00
67-9245 Entrance		
Single Cylinder with Deadbolt		
* 67-9250 Hotel	\$1,956.00	\$2,033.00
Double Cylinder		
* 67-9216 Public Entrance		
67-9217 Asylum	\$1,991.00	\$2,061.00
67-9238 Classroom Security		
* 67-9259 Double Locking		
Double Cylinder with Deadbolt		
67-9226 Storeroom		
67-9239 Classroom Security		
67-9240 Classroom Security	\$2,046.00	\$2,117.00
* 67-9241 Classroom Security		
* 67-9249 Security Deadbolt		
Electro Mechanical Single Cyl. – Specify 12V or 24V		
* 67-9270-12V / 67-9270-24V Fail Safe		
* 67-9271-12V / 67-9271-24V Fail Secure	\$2,190.00	\$2,262.00
Electro Mechanical Double Cyl. – Specify 12V or 24V		
* 67-9272-12V / 67-9272-24V Fail Safe		
* 67-9273-12V / 67-9273-24V Fail Secure	\$2,278.00	\$2,350.00
Non Keyed		
* 67-9215 Passage	\$1,600.00	\$1,674.00
* 67-9265 Privacy	\$1,794.00	\$1,864.00
Keyed with Deadbolt		
* 67-9266 Privacy	\$1,884.00	\$1,953.00

* Not available with Mogul Cylinder (M-option)

ML-168 MORTISE LOCKS

SARGENT®

ASSA ABLOY

OPTIONS-9200

USA & Canada Prices Effective May 1, 2021

Options	Description	Price
3	Stainless Steel Hubs	\$69.00
10▲	SARGENT Signature Key Systems	\$63.00 / cyl.
11	SARGENT XC Key System (not available with 10, 22, SC, SE options)	No addition
21▲	SARGENT Construction Key System (lost ball) Standard on all new systems established since 5/1/96	\$16.00 / cyl.
22▲	SARGENT Construction Key System (split key) To be used on pre-established split key systems only	\$32.00 / cyl.
23	Flat Lip ANSI 4-7/8" Strike	No addition
31	Thick Doors - Extended Lip Required - Specify Length C to E - Cylinders - IMPORTANT- See catalog 7800/8200 option page for cylinder limitations - Below charges DO NOT include additional charges for special cylinder requirements	
	Doors up to 2-1/2" thick - lock centered	No addition
	Doors 2-5/8" to 6" thick OR doors 1-3/4" thick w/max 1" paneling one side.	
	For example: Specify 1-3/4" door with panel (Side) on inside or outside	Non Keyed function \$50.00 Keyed function \$100.00
36	6 Lobe security head screw	\$24.00
67	9200 Knob Outside x Knob Inside	No
Add		
75	Tactile Warning - Milled Inside Knob	\$78.00
76	Tactile Warning - Milled Outside Knob	\$78.00
77	Tactile Warning - Milled Outside and Inside Knob	\$156.00
BR	SARGENT Bump Resistant Cylinders (N/A w/10, 22, 30, 60, 63, 64, 70, 72, 73, 737P, KESO, SC, SE)	\$25.00 /cyl.
LC	Less Cylinder	-\$96.00/cyl.
OBS	Open Back Strike	\$79.00
SG	MicroShield® – an antimicrobial powder coat finish	\$73.00
WBS	Wrought Box Strike	No addition
▲	Not available with 50 function lockout cylinder. * Does NOT meet security Grade 1 requirements	
CPC	Clear Powder Coat over 26D/32D – 9205 x LSB x 32D x CPC All orders will continue to be handled as a "special" when CPC is ordered.	\$67.00



USA & Canada Prices Effective May 1, 2021

Note: Must be ordered with 67 Option

Escutcheon: LS • Knob: K

Function	Finish	
	04/26D	32D
Option Single Cylinder		
67-9204 Storeroom		
67-9205 Office		
67-9206 Service		
67-9237 Classroom	\$2,350.00	\$2,419.00
67-9255 Office		
Single Cylinder with Deadbolt		
67-9224 Storeroom	\$2,397.00	\$2,466.00
67-9225 Dormitory		
67-9235 Storeroom		
Single Cylinder with Deadbolt		
67-9243 Entrance	\$2,419.00	\$2,492.00
67-9245 Entrance		
Single Cylinder with Deadbolt		
67-9250 Hotel	\$2,449.00	\$2,518.00
Double Cylinder		
67-9216 Public Entrance		
67-9217 Asylum	\$2,480.00	\$2,550.00
67-9238 Classroom Security		
67-9259 Double Locking		
Double Cylinder with Deadbolt		
67-9226 Storeroom		
67-9339 Classroom Security		
67-9340 Classroom Security	\$2,534.00	\$2,609.00
67-9341 Classroom Security		
67-9249 Security Deadbolt		
Non Keyed		
67-9215 Passage	\$2,091.00	\$2,161.00
67-9265 Privacy	\$2,283.00	\$2,356.00
Non Keyed with Deadbolt		
67-9266 Privacy	\$2,372.00	\$2,446.00

ML-170 MORTISE LOCKS

SARGENT®

OPTIONS-9200

ASSA ABLOY

USA & Canada Prices Effective May 1, 2021

Options	Description	Price
3	Stainless Steel Hubs	\$69.00
10▲	SARGENT Signature Key Systems	\$63.00 / cyl.
11**†	SARGENT XC Key System (not available with 10, 22, SC, SE options)	No addition
1160	SARGENT XC Large Format Interchangeable Plastic Disposable Construction Core	No addition
1163	SARGENT XC Large Format Interchangeable Core Cylinder - Includes masterkeying charges	\$83.00
1164	SARGENT XC Large Format Interchangeable Construction Core Cylinder	\$83.00
1170	Small Format interchangeable disposable construction core - to accept 7 Pin XC permanent core	No addition
11727P	Small Format interchangeable keyed construction core - to accept 7 Pin XC permanent core	\$75.00
11737P	Small Format interchangeable core - to accept 7 pin XC permanent core	\$75.00 / cyl.
21▲†	SARGENT Construction Key System (lost ball) Standard on all new systems established since 5/1/96	\$16.00 / cyl.
22▲†	SARGENT Construction Key System (split key) To be used on pre-established split key systems only	\$32.00 / cyl.
23	Flat Lip ANSI 4-7/8" Strike	No addition
31	Thick Doors - Extended Lip Required - Specify Length C to E - Cylinders - IMPORTANT- See catalog 7800/8200 option page for cylinder limitations - Below charges DO NOT include additional charges for special cylinder requirements	No addition
	Doors up to 2-1/2" thick - lock centered	No addition
	Doors 2-5/8" to 6" thick OR doors 1-3/4" thick w/max 1" paneling one side.	
	For example: Specify 1-3/4" door with panel (Side) on inside or outside	Non Keyed function \$50.00 Keyed function \$100.00
36	6 Lobe security head screw	\$24.00
60*	SARGENT Large Format Interchangeable Plastic Disposable Construction Core	No addition
63*	SARGENT Large Format Interchangeable core cylinder, includes master keying charges	\$83.00 / cyl.
64*	SARGENT Large Format Interchangeable Construction Core Cylinder	\$83.00
6573*▲†	Small Format 6-Pin Uncombined Core (Refer to CK-12)	\$65.00 / cyl.
65737P*▲†	Small Format 7-Pin Uncombined Core (Refer to CK-12)	\$65.00 / cyl.
67	9200 Knob Outside x Knob Inside	No Add
70*▲†	Small Format Interchangeable disposable plastic construction core	No addition
72*▲†	Small Format Interchangeable 6-pin construction core (7-pin with 11)	\$75.00
73*▲†	Small Format interchangeable core 6-pin Includes MK and GMK keying charges	\$75.00 / cyl.
737P*▲†	Small Format interchangeable core 7-pin (refer to CK-12 for available keyways) Includes MK and GMK keying charges	\$75.00 / cyl.
75	Tactile Warning - Milled Inside Knob	\$78.00
76	Tactile Warning - Milled Outside Knob	\$78.00
77	Tactile Warning - Milled Outside and Inside Knob	\$156.00
81▲†	Cylinder to accept Keso (83) and Keso F1 (F183) removable core – no core provided	No addition
F182†	SARGENT Keso Security Cylinder – patented – new key systems	\$91.00
F183▲†	SARGENT Keso Security Removable Core Cylinder – patented – new key systems	\$130.00
82†	SARGENT Keso Security Cylinder (For existing systems only)	\$91.00
83▲†	SARGENT Keso Security Removable Core Cylinder (For existing systems only)	\$130.00
84▲†	SARGENT Keso Security Removable Construction Core Cylinder	See CK-18
AV	Anti Vandal Pull Trim (available in 32D finish), (Not available with 9270, 9271, 9272, 9273 functions)	\$229.00
DG1	Patented Degree DG1 Key System	No addition
DG160	Hardware prepared for DG1-6300 Lg. Format IC cores, supplied with temporary plastic construction cores	No addition
DG163	Patented Degree DG1 Large Format Interchangeable Core Cylinder - Includes master keying charges	\$83.00
DG164	Hardware prepared for DG1-6300 Lg. Format IC cores, supplied with temporary keyed construction cores	\$83.00
DG2	Patented Degree DG2 Key System incorporating a locking sidebar	\$63.00/cyl.
DG260	Hardware prepared for DG2-6300 Lg. Format IC cores, supplied with temporary plastic construction cores	No addition
DG263	Patented Degree DG2 Large Format Interchangeable Core Cylinder - Includes master keying charges	\$146.00
DG264	Hardware prepared for DG2-6300 Lg. Format IC cores, supplied with temporary keyed construction cores	\$83.00
DG3	Patented Degree DG3 Key System incorporating a locking sidebar and UL437 listed	\$89.00/cyl.
DG360	Hardware prepared for DG3-6300 Lg. Format IC cores, supplied with temporary plastic construction cores	No addition
DG363	Patented Degree DG3 Large Format Interchangeable Core Cylinder - Includes master keying charges	\$172.00
DG364	Hardware prepared for DG3-6300 Lg. Format IC cores, supplied with temporary keyed construction cores	\$83.00
LC	Less Cylinder	-\$96.00/cyl.
OBS	Open Back Strike	\$79.00
M▲†	Mogul Lock - Mogul Cylinder to be ordered separate (Cylinder not included and do not receive Less Cylinder deduct	\$427.00
SG	MicroShield® – an antimicrobial powder coat finish	\$73.00
WBS	Wrought Box Strike	No addition

- ▲ Not available with 50 function lockout cylinder.
- * Does NOT meet security Grade 1 requirements.
- ** Not available with M- option.
- † Not available with 60, 63, 64 options

CPC Clear Powder Coat over 32D – 9205 x BHD x 32D x CPC All orders will continue to be handled as a "special" when CPC is ordered. \$67.00

Experience a safer
and more open world

Copyright © 2002-2021 Sargent Manufacturing Company, an ASSA ABLOY Group company. All rights reserved.
Reproduction in whole or in part without the express written permission of Sargent Manufacturing Company is prohibited.
Contact us at: 800-727-5477 or visit www.sargentlock.com. In Canada contact us at: 800-461-3007 or visit www.assaabloydss.ca



SLD
Rose: SL (shown)
Knob: D (shown)

USA & Canada Prices Effective May 1, 2021

NOTE: Not ADA Compliant. Must be ordered with 67 option.

(Provided with Knurled Security Trim and Torx® Security Screws)

Function	Finish
Option Single Cylinder	32D
67-9204 Storeroom	
67-9205 Office	
67-9206 Service	\$2,698.00
67-9237 Classroom	
67-9255 Office	
Single Cylinder with Deadbolt	
67-9224 Storeroom	\$2,747.00
67-9225 Dormitory	
67-9235 Storeroom	
Single Cylinder with Deadbolt	
67-9243 Entrance	\$2,770.00
67-9245 Entrance	
Single Cylinder with Deadbolt	
* 67-9250 Hotel	\$2,797.00
Double Cylinder	
* 67-9216 Public Entrance	
67-9217 Asylum	\$2,827.00
67-9238 Classroom Security	
* 67-9259 Double Locking	
Double Cylinder with Deadbolt	
67-9226 Storeroom	
67-9239 Classroom Security	
67-9240 Classroom Security	\$2,882.00
* 67-9241 Classroom Security	
* 67-9249 Security Deadbolt	
Electro Mechanical Single Cyl. – Specify 12V or 24V	
* 67-9270-12V / 67-9270-24V Fail Safe	
* 67-9271-12V / 67-9271-24V Fail Secure	\$3,027.00
Electro Mechanical Double Cyl. – Specify 12V or 24V	
* 67-9272-12V / 67-9272-24V Fail Safe	
* 67-9273-12V / 67-9273-24V Fail Secure	\$3,117.00
Non Keyed	
* 67-9215 Passage	\$2,442.00
* 67-9265 Privacy	\$2,632.00
Keyed with Deadbolt	
* 67-9266 Privacy	\$2,724.00

* Not available with Mogul Cylinder (M-option)

ML-172 MORTISE LOCKS

SARGENT®

9200 SERIES BEHAVIORAL HEALTH KNOB TRIM (BHD) OPTIONS

ASSA ABLOY

USA & Canada Prices Effective May 1, 2021

Options	Description	Price
3	Stainless Steel Hubs	\$69.00
10▲	SARGENT Signature Key Systems	\$63.00 / cyl.
11**†	SARGENT XC Key System (not available with 10, 22, SC, SE options)	No addition
1160	SARGENT XC Large Format Interchangeable Plastic Disposable Construction Core	No addition
1163	SARGENT XC Large Format Interchangeable Core Cylinder - Includes masterkeying charges	\$83.00
1164	SARGENT XC Large Format Interchangeable Construction Core Cylinder	\$83.00
1170	Small Format interchangeable disposable construction core - to accept 7 Pin XC permanent core	No addition
11727P	Small Format interchangeable keyed construction core - to accept 7 Pin XC permanent core	\$75.00
11737P	Small Format interchangeable core - to accept 7 pin XC permanent core	\$75.00 / cyl.
21▲†	SARGENT Construction Key System (lost ball) Standard on all new systems established since 5/1/96	\$16.00 / cyl.
22▲†	SARGENT Construction Key System (split key) To be used on pre-established split key systems only	\$32.00 / cyl.
23	Flat Lip ANSI 4-7/8" Strike	No addition
31	Thick Doors - Extended Lip Required - Specify Length C to E - Cylinders - IMPORTANT- See catalog 7800/8200 option page for cylinder limitations - Below charges DO NOT include additional charges for special cylinder requirements Doors up to 2-1/2" thick - lock centered Doors 2-5/8" to 6" thick OR doors 1-3/4" thick w/max 1" paneling one side. For example: Specify 1-3/4" door with panel (Side) on inside or outside	No addition Non Keyed function \$50.00 Keyed function \$100.00
36	6 Lobe security head screw	\$24.00
60*	SARGENT Large Format Interchangeable Plastic Disposable Construction Core	No addition
63*	SARGENT Large Format Interchangeable core cylinder, includes master keying charges	\$83.00 / cyl.
64*	SARGENT Large Format Interchangeable Construction Core Cylinder	\$83.00
6573*▲†	Small Format 6-Pin Uncombined Core (Refer to CK-12)	\$65.00 / cyl.
65737P*▲†	Small Format 7-Pin Uncombined Core (Refer to CK-12)	\$65.00 / cyl.
67	9200 Knob Outside x Knob Inside	No Add
70*▲†	Small Format Interchangeable disposable plastic construction core	No addition
72*▲†	Small Format Interchangeable 6-pin construction core (7-pin with 11)	\$75.00
73*▲†	Small Format interchangeable core 6-pin Includes MK and GMK keying charges	\$75.00 / cyl.
737P*▲†	Small Format interchangeable core 7-pin (refer to CK-12 for available keyways) Includes MK and GMK keying charges	\$75.00 / cyl.
75	Tactile Warning - Milled Inside Knob	\$78.00
76	Tactile Warning - Milled Outside Knob	\$78.00
77	Tactile Warning - Milled Outside and Inside Knob	\$156.00
81▲†	Cylinder to accept Keso (83) and Keso F1 (F183) removable core – no core provided	No addition
F182†	SARGENT Keso Security Cylinder – patented – new key systems	\$91.00
F183▲†	SARGENT Keso Security Removable Core Cylinder – patented – new key systems	\$130.00
82†	SARGENT Keso Security Cylinder (For existing systems only)	\$91.00
83▲†	SARGENT Keso Security Removable Core Cylinder (For existing systems only)	\$130.00
84▲†	SARGENT Keso Security Removable Construction Core Cylinder	See CK-18
AV	Anti Vandal Pull Trim (available in 32D finish), (Not available with 9270, 9271, 9272, 9273 functions)	\$229.00
DG1	Patented Degree DG1 Key System	No addition
DG160	Hardware prepared for DG1-6300 Lg. Format IC cores, supplied with temporary plastic construction cores	No addition
DG163	Patented Degree DG1 Large Format Interchangeable Core Cylinder - Includes master keying charges	\$83.00
DG164	Hardware prepared for DG1-6300 Lg. Format IC cores, supplied with temporary keyed construction cores	\$83.00
DG2	Patented Degree DG2 Key System incorporating a locking sidebar	\$63.00/cyl.
DG260	Hardware prepared for DG2-6300 Lg. Format IC cores, supplied with temporary plastic construction cores	No addition
DG263	Patented Degree DG2 Large Format Interchangeable Core Cylinder - Includes master keying charges	\$146.00
DG264	Hardware prepared for DG2-6300 Lg. Format IC cores, supplied with temporary keyed construction cores	\$83.00
DG3	Patented Degree DG3 Key System incorporating a locking sidebar and UL437 listed	\$89.00/cyl.
DG360	Hardware prepared for DG3-6300 Lg. Format IC cores, supplied with temporary plastic construction cores	No addition
DG363	Patented Degree DG3 Large Format Interchangeable Core Cylinder - Includes master keying charges	\$172.00
DG364	Hardware prepared for DG3-6300 Lg. Format IC cores, supplied with temporary keyed construction cores	\$83.00
LC	Less Cylinder	-\$96.00/cyl.
OBS	Open Back Strike	\$79.00
M▲†	Mogul Lock - Mogul Cylinder to be ordered separate (Cylinder not included and do not receive Less Cylinder deduct	\$427.00
SG	MicroShield® – an antimicrobial powder coat finish	\$73.00
WBS	Wrought Box Strike	No addition

- ▲ Not available with 50 function lockout cylinder.
- * Does NOT meet security Grade 1 requirements.
- ** Not available with M- option.
- † Not available with 60, 63, 64 options

CPC Clear Powder Coat over 32D – 9205 x BHD x 32D x CPC \$67.00
All orders will continue to be handled as a "special" when CPC is ordered.

Experience a safer
and more open world

Copyright © 2002-2021 Sargent Manufacturing Company, an ASSA ABLOY Group company. All rights reserved.
Reproduction in whole or in part without the express written permission of Sargent Manufacturing Company is prohibited.
Contact us at: 800-727-5477 or visit www.sargentlock.com. In Canada contact us at: 800-461-3007 or visit www.assaabloydss.ca

9200 SERIES BEHAVIORAL HEALTH KNOB TRIM (BHD)

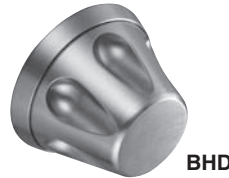

USA & Canada Prices Effective May 1, 2021

NOTE: Not ADA Compliant. Must be ordered with 67 option.

(Provided with Torx® Security Screws)

Function		Finish
Option	Single Cylinder	32D
67-9204	Storeroom	
67-9205	Office	
67-9206	Service	\$2,698.00
67-9237	Classroom	
67-9255	Office	
Single Cylinder with Deadbolt		
67-9224	Storeroom	\$2,747.00
67-9225	Dormitory	
67-9235	Storeroom	
Single Cylinder with Deadbolt		
67-9243	Entrance	\$2,770.00
67-9245	Entrance	
Single Cylinder with Deadbolt		
* 67-9250	Hotel	\$2,797.00
Double Cylinder		
* 67-9216	Public Entrance	
67-9217	Asylum	\$2,827.00
67-9238	Classroom Security	
* 67-9259	Double Locking	
Double Cylinder with Deadbolt		
67-9226	Storeroom	
67-9239	Classroom Security	
67-9240	Classroom Security	\$2,882.00
* 67-9241	Classroom Security	
* 67-9249	Security Deadbolt	
Electro Mechanical Single Cyl. – Specify 12V or 24V		
* 67-9270-12V / 67-9270-24V	Fail Safe	\$3,027.00
* 67-9271-12V / 67-9271-24V	Fail Secure	
Electro Mechanical Double Cyl. – Specify 12V or 24V		
* 67-9272-12V / 67-9272-24V	Fail Safe	\$3,117.00
* 67-9273-12V / 67-9273-24V	Fail Secure	
Non Keyed		
* 67-9215	Passage	\$2,442.00
* 67-9265	Privacy	\$2,632.00
Keyed with Deadbolt		
* 67-9266	Privacy	\$2,724.00

* Not available with Mogul Cylinder (M-option)

ML-174 MORTISE LOCKS

SARGENT®

9200 SERIES BEHAVIORAL HEALTH (BHW) TRIM OPTIONS

ASSA ABLOY

USA & Canada Prices Effective May 1, 2021

Options	Description	Price
10▲	SARGENT Signature Key System	\$63.00 / cyl.
11†▲	SARGENT XC Key System (not available with 10, 22, SC, SE options)	No addition
1160	SARGENT XC Large Format Interchangeable Plastic Disposable Construction Core	No addition
1163	SARGENT XC Large Format Interchangeable Core Cylinder - Includes masterkeying charges	\$83.00
1164	SARGENT XC Large Format Interchangeable Construction Core Cylinder	\$83.00
1170	Small Format interchangeable disposable construction core - to accept 7 Pin XC permanent core	No addition
11727P	Small Format interchangeable keyed construction core - to accept 7 Pin XC permanent core	\$75.00
11737P	Small Format interchangeable core - to accept 7 pin XC permanent core	\$75.00 / cyl.
21▲†	SARGENT Construction Key System (lost ball) Standard on all new systems established since 5/1/96	\$16.00 / cyl.
22▲†	SARGENT Construction Key System (split key) To be used on pre-established split key systems only	\$32.00 / cyl.
23	Locksets with flat 4-7/8" ANSI strike	No addition
31	Thick Doors - Extended Lip Required - Specify Length C to E – Cylinders - IMPORTANT- See 8200 Push/Pull trim catalog option page for cylinder limitations – Below charges DO NOT include additional charges for special cylinder requirements Doors up to 2-1/4" thick - lock centered – IF PANNELED – must specify panel thickness & panel location (inside or outside) For example: Specify 1-3/4" door with panel (Side) on inside or outside For doors thicker than 2-1/4" - consult factory	No addition Non Keyed function \$50.00 Keyed function \$100.00
49	Occupancy indicator with emergency release - Available with 65, 66, & 68 functions	\$140.00
60	SARGENT Large Format Interchangeable Plastic Disposable Construction Core	No addition
63	SARGENT Large Format Interchangeable core cylinder, includes master keying charges	\$83.00 / cyl.
64	SARGENT Large Format Interchangeable Construction Core Cylinder	\$83.00
6573▲†	Small Format 6-Pin Uncombined Core (Refer to CK-12)	\$65.00 / cyl.
65737P▲†	Small Format 7-Pin Uncombined Core (Refer to CK-12)	\$65.00 / cyl.
70▲†	Small Format Interchangeable disposable plastic construction core	No addition
72▲†	Small Format Interchangeable 6-pin construction core (7-pin with 11 option)	\$75.00
73▲†	Small Format interchangeable core 6-pin Includes MK and GMK keying charges	\$75.00 / cyl
737P▲†	Small Format interchangeable core 7-pin (refer to CK-12 for available keyways) Includes MK and GMK keying charges	\$75.00 / cyl
74*	Lead Lining or Wrapping	\$294.00
81▲†	Cylinder to accept Keso (83) and Keso F1 (F183) removable core – no core provided	No Addition
F182†	SARGENT Keso Security Cylinder – patented – new key systems	\$91.00 / cyl.
F183▲†	SARGENT Keso Security Removable Core Cylinder – patented – new key systems	\$130.00 / cyl.
82†	SARGENT Keso Security Cylinder (For existing systems only)	\$91.00 / cyl.
83▲†	SARGENT Keso Security Removable Core Cylinder (For existing systems only)	\$130.00 / cyl.
84▲†	SARGENT Keso Security Removable Construction Core Cylinder	See page CK-18
BR	SARGENT Bump Resistant Cylinders (N/A w/10, 22, 30, 60, 63, 64, 70, 72, 73, 737P, KESO, SC, & SE options)	\$25.00 /cyl.
DG1	Patented Degree DG1 Key System	No addition
DG160	Hardware prepared for DG1-6300 Lg. Format IC cores, supplied with temporary plastic construction cores	No addition
DG163	Patented Degree DG1 Large Format Interchangeable Core Cylinder - Includes master keying charges	\$83.00
DG164	Hardware prepared for DG1-6300 Lg. Format IC cores, supplied with temporary keyed construction cores	\$83.00
DG2	Patented Degree DG2 Key System incorporating a locking sidebar	\$63.00/cyl.
DG260	Hardware prepared for DG2-6300 Lg. Format IC cores, supplied with temporary plastic construction cores	No addition
DG263	Patented Degree DG2 Large Format Interchangeable Core Cylinder - Includes master keying charges	\$146.00
DG264	Hardware prepared for DG2-6300 Lg. Format IC cores, supplied with temporary keyed construction cores	\$83.00
DG3	Patented Degree DG3 Key System incorporating a locking sidebar and UL437 listed	\$89.00/cyl.
DG360	Hardware prepared for DG3-6300 Lg. Format IC cores, supplied with temporary plastic construction cores	No addition
DG363	Patented Degree DG3 Large Format Interchangeable Core Cylinder - Includes master keying charges	\$172.00
DG364	Hardware prepared for DG3-6300 Lg. Format IC cores, supplied with temporary keyed construction cores	\$83.00
LC	Less Cylinder	-\$96.00/cyl.
M	Mogul Lock – Mogul Cylinder to be ordered separate (See V-10 Cylinder section for Mogul Cylinder & price)	\$427.00
OBS	Open Back Strike	\$79.00
RX	Request to Exit	\$206.00
SC▲†	Schlage "C" Keyway cylinder, (Number 41 Cylinder Only, 0 bitted)	No Addition
SE▲†	Schlage "E" Keyway cylinder, (Number 41 Cylinder Only, 0 bitted)	No Addition
SG	MicroShield® – an antimicrobial powder coat finish	\$75.00
WBS	Wrought Box Strike	No Addition

▲ Options not available with a standard 50 function lockout cylinder.

† Not available with 60, 63, 64 options

CPC Clear Powder Coat over 32/32D. All orders will continue to be handled as a "special" when CPC is ordered. \$67.00

Experience a safer
and more open world

Copyright © 2002-2021 Sargent Manufacturing Company, an ASSA ABLOY Group company. All rights reserved.
Reproduction in whole or in part without the express written permission of Sargent Manufacturing Company is prohibited.
Contact us at: 800-727-5477 or visit www.sargentlock.com. In Canada contact us at: 800-461-3007 or visit www.assaabloydss.ca



9200 SERIES BEHAVIORAL HEALTH TRIM (BHW)

BHW

USA & Canada Prices Effective May 1, 2021

Function		Finish
Single Cyl		32D
9204	Storeroom or Closet	
*9205	Office or Entry	
9237	Classroom	\$1,956.00
9255	Office or Entry	
Single Cyl With Deadbolt		
*9224	Room Door	
*9225	Dormitory or Exit	\$1,993.00
*9235	Storeroom	
*9243	Apartment Corridor	
*9245	Dormitory or Exit	
*9250	Hotel Guest Lock	\$2,031.00
Double Cyl No Deadbolt		
*9216	Apartment or Exit or Public Toilet	
9217	Asylum or Institutional	\$2,054.00
9238	Classroom Security Intruder	
9259	School Security	
Double Cyl With Deadbolt		
9226	Store Door	
9239, 9240	Classroom Security Intruder	\$2,098.00
9241	Classroom Security	
9249	Security Deadbolt	
Electro Mechanical Single Cyl – Specify 12V or 24V		
9270-12V/9270-24V	Fail Safe	\$2,152.00
9271-12V/9271-24V	Fail Secure	
Electro Mechanical Double Cyl – Specify 12V or 24V		
9272-12V/9272-24V	Fail Safe	\$2,209.00
9273-12V/9273-24V	Fail Secure	
Non Keyed		
9215	Passage or Closet	\$1,874.00
*9265	Privacy Bedroom or Bath (Latch)	\$1,906.00
*9266	Privacy Bedroom or Bath (D.bolt)	\$1,974.00

Note: Lockbodies only for BHW trim, refer to page ML-174.

* Functions not available with Mogul Cylinder (M- option).

ML-176 MORTISE LOCKS

SARGENT®

ASSA ABLOY

9200 DEADLOCKS/LOCK BODIES

USA & Canada Prices Effective May 1, 2021

9200 Deadlock (No Trim)

Function			Finish	
Single Cylinder Deadlock	Function Description		04/26D	32D
9203	Cylinder x Thumbturn	Classroom Deadlock	\$667.00	\$740.00
9220	Cylinder	Deadlock	\$596.00	\$667.00
9221	Cylinder x Thumbturn	Deadlock	\$667.00	\$740.00
Double Cylinder Deadlock				
9222	Cylinder	Deadlock	\$695.00	\$760.00
9223	Cylinder x Thumbturn	Deadlock	\$760.00	\$835.00

9200 Lockbodies (No Trim)

Function			Finishes	
Single Cylinder	Function Description		04/26D/32D	
Cat. # For Lever Trim:	Cat. # For Knob Trim			
9204	67-9204	Storeroom or Closet		
9205	67-9205	Office or Entry		
9206	67-9206	Service or Service		\$799.00
9237	67-9237	Classroom		
9255	67-9255	Office or Entry		
Single Cylinder with Deadbolt				
9224	67-9224	Storeroom		
9225	67-9225	Dormitory or Exit		
9235	67-9235	Storeroom		\$864.00
9243	67-9243	Apartment Corridor		
9245	67-9245	Dormitory or Exit		
9250	67-9250	Hotel Guest		
Double Cylinder				
9216	67-9216	Apartment, Exit or Public Restroom		
9217	67-9217	Asylum or Institutional		\$799.00
9238	67-9238	Classroom Security Intruder		
9259	67-9259	School Security		
Double Cylinder with Deadbolt				
9226	67-9226	Store Door		
9239	67-9239	Classroom Security Intruder		
9240	67-9240	Classroom Security Intruder		\$864.00
9241	67-9241	Classroom Security		
9249	67-9249	Security		
Electro Mechanical Single Cyl. – Specify 12V or 24V				
9270-12V / -24V	67-9270-12V / -24V	Electrical Fail Safe		\$1,173.00
9271-12V / -24V	67-9271-12V / -24V	Electrical Fail Secure		
Electro Mechanical Double Cyl. – Specify 12V or 24V				
9272-12V / -24V	67-9272-12V / -24V	Electrical Fail Safe		\$1,173.00
9273-12V / -24V	67-9273-12V / -24V	Electrical Fail Secure		
Non-Keyed				
9215	67-9215	Passage or Closet		\$558.00
9265	67-9265	Privacy Bedroom or Bath-latch		\$740.00
9266	67-9266	Privacy Bedroom or Bath-deadbolt		\$822.00

Note: Cylinder and trim not included with lockbodies. Outside front, strike and screwpack are included.

Lockbodies with options 3, 68, 69, or M or any combination, please consult factory for correct part # and price.

USA & Canada Prices Effective May 1, 2021

9200 Trim - Specify finish when ordering			Price	
Part #	Design	Description	04/26D	32D
	B, J, L, P	Levers - Same as 8200 - refer to 8200 Lever Section	refer to 8200 section	
	LE3, LE4, LS	Escutcheons - Same as 8200 - refer to 8200 Inside and Outside Escutcheon Section.	refer to 8200 section	
	LN, L	Rose - Same as 8200 - refer to 8200 Rose Section	refer to 8200 section	
92-0034	SN	Rose - Security Trim ONLY - requires 92-2171 Trim Pack	\$50.53	\$56.37
92-0064	SL	Rose - Security Trim ONLY - requires 92-2173 Trim Pack	\$50.53	\$56.37
92-0091	BH	Rose	\$40 (32)	\$38.00
92-2142		Detention Knob for M9200 - O/S Assy. (Cone Shaped)	\$497.30	\$514.43
9200 Accessories - Specify finish when ordering			Price	
Part #	Description		04/26D	32D
184SKB	Outside Emergency Release Assembly (with Torx screws)		\$54.00	\$67.00
130SKB	Thumbturn Lever Assembly (Torx screws only)		\$54.00	\$67.00
130SB	Knurled Knob Assembly (with Torx screws)		\$186.00	\$191.00
9200 Miscellaneous Parts			Price	
Part #	Description		Price	
*M92	Blocking Ring		\$96.00	
01-4402	Lockbody Case/Cap Machine Screw - #8-32 x 5/16" (5 per lockbody)		\$0.54	
*92	Blocking Ring		\$57.00	
*92-0015	O/S Front (15, 65)		\$50.33	
*92-0016	O/S Front (04, 06, 13, 16, 17, 31, 36, 37, 38, 67, 70, 71, 72, 73, 78, 79)		\$50.33	
*92-0017	O/S Front (03, 20, 21, 22, 23)		\$50.33	
*92-0018	O/S Front (24, 25, 26)		\$50.33	
*92-0019	O/S Front (40, 41, 50, 51, 52, 76, 77)		\$50.33	
*92-0020	O/S Front (05)		\$50.33	
*92-0021	O/S Front (45)		\$50.33	
*92-0022	O/S Front (43)		\$50.33	
92-0066	Mogul Cylinder Camp Spring		\$3.38	
*92-0072	M- O/S Front (04, 16, 17, 17, 37)		\$50.33	
*92-0073	M- O/S Front (03, 20, 21, 22, 23)		\$50.33	
*92-0074	M- O/S Front (24, 25, 26)		\$50.33	
*92-0075	M- O/S Front (40, 41, 50, 51, 52, 76, 77)		\$50.33	
*92-0076	M- O/S Front (05)		\$50.33	
*92-0077	M- O/S Front (45)		\$50.33	
*92-0078	M- O/S Front (43)		\$50.33	
*92-0079	O/S Front (70, 71, 72, 73)		\$50.33	
*92-0080	M- O/S Front (70, 71, 72, 73)		\$50.33	
92-2151	SN Adaptor & Plate Assembly		\$11.52	
92-2152	SL Adaptor & Plate Assembly		\$13.87	
92-2171	Trim Pack (SN)		\$73.49	
92-2173	Trim Pack (SL)		\$73.49	
*1AB-1	Tapered Cyl. Rosette		\$121.00	
*1MB-1	Tapered Cyl. Rosette		\$107.00	
*1SB-1	Cylinder Ring Rosette		\$60.00	

Note: Must consult factory for parts relating to M9200's.

* Specify finish when ordering – 4, 26D, 32D.

ML-178 MORTISE LOCKS

SARGENT®

9200 INSIDE TRIM SET

ASSA ABLOY

USA & Canada Prices Effective May 1, 2021

Lock Function					Rose	Lever	04/26D	32D
IS-9204	IS-9235	IS-9245			L, LN SN, SL	B, J, L, P B, J, L, P	\$440.00 \$480.00	\$476.00 \$516.00
IS-9205	IS-9237	IS-9270						
IS-9206	IS-9255	IS-9271						
IS-9215	IS-9243							
IS-9216	IS-9259	IS-9249			L, LN SN, SL	B, J, L, P B, J, L, P	\$451.00 \$490.00	\$483.00 \$522.00
IS-9217	IS-9239	IS-9272						
IS-9226	IS-9240	IS-9273						
IS-9238	IS-9241							
IS-9224	IS-9250	IS-9266			L, LN	B, J, L, P	\$482.00	\$518.00
IS-9225	IS-9265				SN, SL	B, J, L, P	\$521.00	\$558.00
Lock Function					Escutcheon	Lever	04/26D	32D
IS-9204	IS-9237	IS-9255	IS-9271		LE3	B, J, L, P	\$484.00	\$521.00
IS-9205	IS-9215	IS-9270						
IS-9243	IS-9224	IS-9250	IS-9266		LE3	B, J, L, P	\$519.00	\$553.00
IS-9245	IS-9225	IS-9265						
Lock Function					Escutcheon	Lever	04/26D	32D
IS-9204	IS-9206	IS-9235	IS-9243	IS-9255	LS	B, J, L, P	\$627.00	\$665.00
IS-9205	IS-9215	IS-9237	IS-9245					
IS-9216	IS-9226	IS-9239	IS-9241	IS-9259	LS	B, J, L, P	\$632.00	\$670.00
IS-9217	IS-9238	IS-9240	IS-9249					
IS-9224	IS-9250	IS-9266			LS	B, J, L, P	\$668.00	\$704.00
IS-9225	IS-9265							
Lock Function					Rose	Knob	04/26D	32D
IS-9204	IS-9235	IS-9255			SL, SN	K	\$561.00	\$595.00
IS-9205	IS-9237	IS-9270						
IS-9206	IS-9243	IS-9271						
IS-9215	IS-9245							
IS-9216	IS-9259	IS-9249			SL, SN	K	\$567.00	\$603.00
IS-9217	IS-9239	IS-9272						
IS-9226	IS-9240	IS-9273						
IS-9238	IS-9241							
IS-9224	IS-9250	IS-9266			SL, SN	K	\$594.00	\$629.00
IS-9225	IS-9265							
Lock Function					Rose	Knob	32D	32
IS-9204	IS-9235	IS-9255			SL	D	\$809.00	\$844.00
IS-9205	IS-9237	IS-9270						
IS-9206	IS-9243	IS-9271						
IS-9215	IS-9245							
IS-9216	IS-9259	IS-9249			SL	D	\$817.00	\$854.00
IS-9217	IS-9239	IS-9272						
IS-9226	IS-9240	IS-9273						
IS-9238	IS-9241							
IS-9224	IS-9250	IS-9266			SL	D	\$842.00	\$880.00
IS-9225	IS-9265							
Lock Function					Rose	Knob	32D	32
IS-9204	IS-9235	IS-9255			BH	D	\$809.00	\$844.00
IS-9205	IS-9237	IS-9270						
IS-9206	IS-9243	IS-9271						
IS-9215	IS-9245							
IS-9216	IS-9259	IS-9249			BH	D	\$817.00	\$854.00
IS-9217	IS-9239	IS-9272						
IS-9226	IS-9240	IS-9273						
IS-9238	IS-9241							
IS-9224	IS-9250	IS-9266			BH	D	\$842.00	\$880.00
IS-9225	IS-9265							
Lock Function					Escutcheon	Knob	04/26D	32D
IS-9204	IS-9235	IS-9255			LS	K	\$710.00	\$745.00
IS-9205	IS-9237	IS-9270						
IS-9206	IS-9243	IS-9271						
IS-9215	IS-9245							
IS-9216	IS-9259	IS-9249			LS	K	\$716.00	\$750.00
IS-9217	IS-9239	IS-9272						
IS-9226	IS-9240	IS-9273						
IS-9238	IS-9241							
IS-9224	IS-9250	IS-9266			LS	K	\$741.61	\$776.00
IS-9225	IS-9265							

Experience a safer
and more open world

Copyright © 2002-2021 Sargent Manufacturing Company, an ASSA ABLOY Group company. All rights reserved.
Reproduction in whole or in part without the express written permission of Sargent Manufacturing Company is prohibited.
Contact us at: 800-727-5477 or visit www.sargentlock.com. In Canada contact us at: 800-461-3007 or visit www.assaabloydss.ca

USA & Canada Prices Effective May 1, 2021

Lock Function	Rose	Lever	04/26D	32D
OS-9204 OS-9224 OS-9239 OS-9249 OS-9271 OS-9205 OS-9225 OS-9240 OS-9250 OS-9272 OS-9206 OS-9226 OS-9241 OS-9255 OS-9273 OS-9216 OS-9237 OS-9243 OS-9259 OS-9217 OS-9238 OS-9245 OS-9270	L, LN SN, SL	B, J, L, P B, J, L, P	\$468.00 \$511.00	\$505.00 \$549.00
OS-9215	L, LN SN, SL	B, J, L, P B, J, L, P	\$459.00 \$503.00	\$497.00 \$537.00
OS-9265 OS-9266	L, LN SN, SL	B, J, L, P B, J, L, P	\$484.00 \$526.00	\$521.00 \$565.00
Lock Function	Escutcheon	Lever	04/26D	32D
OS-9204 OS-9224 OS-9250 OS-9245 OS-9205 OS-9225 OS-9255 OS-9270 OS-9206 OS-9237 OS-9243 OS-9271	LE3 & LE4	B, J, L, P	\$519.00	\$553.00
OS-9215	LE3 & LE4	B, J, L, P	\$511.00	\$549.00
OS-9265 OS-9266	LE3 & LE4	B, J, L, P	\$536.00	\$571.00
Lock Function	Escutcheon	Lever	04/26D	32D
OS-9204 OS-9217 OS-9237 OS-9241 OS-9250 OS-9205 OS-9224 OS-9238 OS-9243 OS-9255 OS-9206 OS-9225 OS-9239 OS-9245 OS-9259 OS-9216 OS-9226 OS-9240 OS-9249	LS	B, J, L, P	\$668.00	\$704.00
OS-9215	LS	B, J, L, P	\$662.00	\$696.00
OS-9265 OS-9266	LS	B, J, L, P	\$684.00	\$720.00
Lock Function	Rose	Knob	04/26D	32D
OS-9204 OS-9224 OS-9239 OS-9249 OS-9271 OS-9205 OS-9225 OS-9240 OS-9250 OS-9272 OS-9206 OS-9226 OS-9241 OS-9255 OS-9273 OS-9216 OS-9237 OS-9243 OS-9259 OS-9217 OS-9238 OS-9245 OS-9270	SN, SL	K	\$595.00	\$630.00
OS-9215	SN, SL	K	\$588.00	\$624.00
OS-9265 OS-9266	SN, SL	K	\$612.00	\$650.00
Lock Function	Escutcheon	Knob	32D	32
OS-9204 OS-9224 OS-9239 OS-9249 OS-9271 OS-9205 OS-9225 OS-9240 OS-9250 OS-9272 OS-9206 OS-9226 OS-9241 OS-9255 OS-9273 OS-9216 OS-9237 OS-9243 OS-9259 OS-9217 OS-9238 OS-9245 OS-9270	SL	D	\$863.00	\$900.00
OS-9215	SL	D	\$856.00	\$891.00
OS-9265 OS-9266	SL	D	\$881.00	\$918.00
Lock Function	Escutcheon	Knob	04/26D	32D
OS-9204 OS-9224 OS-9239 OS-9249 OS-9271 OS-9205 OS-9225 OS-9240 OS-9250 OS-9272 OS-9206 OS-9226 OS-9241 OS-9255 OS-9273 OS-9216 OS-9237 OS-9243 OS-9259 OS-9217 OS-9238 OS-9245 OS-9270	LS	K	\$753.00	\$789.00
OS-9215	LS	K	\$746.00	\$782.00
OS-9265 OS-9266	LS	K	\$773.00	\$806.00

MULTI-POINT LOCKING HARDWARE

How to Order - ANSI Finish & Function Comparison MP-1

7000 Series

Options MP-2

7000 Series Vertical Rod Lock..... MP-3

AD7000 Series

Options MP-4

AD7000 Series Vertical Rod Lock..... MP-5

WD7000 Series

Options MP-6

WD7000 Series Vertical Rod Lock..... MP-7

ER/ES/ET Lever Control Trim

ER/ES/ET Standard, Coastal and Studio Collection
(Except Gramercy Series) Lever Control Trim..... MP-8

ER/ES/ET Gramercy Series Lever Control Trim..... MP-9

7000 Rod Replacement Kits, Locking Slide..... MP-10

Parts MP-11

FM6100 Series

Options MP-12

FM6100 Series Multi-Point Auto Deadlocking
Storm Shutter System MP-13

7300/BL7300/FM7300 Series

Options MP-14

7300/BL7300/FM7300 Series Multi-Point Lock..... MP-15

Options MP-16

7300/BL7300/FM7300 Series Multi-Point Lock..... MP-17

Options MP-18

7300/BL7300/FM7300 Series Multi-Point Lock..... MP-19

Options MP-20

7300/BL7300/FM7300 Series Multi-Point Lock..... MP-21

Options MP-22

7300/BL7300/FM7300 Series Freewheeling Multi-Point Lock..... MP-23

How To Order

Step	Description	Example
Quantity	Each	10 Ea.
Option	Consult proper section for options available	10 Ea. 12-
Series	70, AD70, or WD70	10 Ea. 12-70
Outside Function	Consult proper section for functions available	10 Ea. 12-7006
Inside Function	Consult proper section for functions available	10 Ea. 12-700613
Trim	Consult proper section for trims available	10 Ea. 12-700613 ETL
Hand	Consult proper section for handing required	10 Ea. 12-700613 ETL LHRB
Finish	Consult proper section for finishes available	10 Ea. 12-700613 ETL LHRB 26
Door Height	Specify Height of Door	10 Ea. 12-700613 ETL LHRB 26 96"

ANSI Finish and Function Comparison

Function		Finish		
SARGENT	ANSI	SARGENT	ANSI	Description
10-DT	02	US3	605	Polished Brass
13	08	US4	606	Satin Brass
15	14	US9	611	Polished Bronze
06	09	US10	612	Satin Bronze
16	10	US10B	613	Oxidized Satin Bronze/Oil Rubbed
40	Similar to 02	US10BE	613E	Dark Oxidized Satin Bronze - Equivalent
43	Similar to 08	US10BL	—	Oxidized Satin Bronze/Lacquered
46	Similar to 09	US14	618	Bright nickel, clear coated
		US15	619	Satin nickel, clear coated
		US20D	—	Dark Statuary Bronze Powder Coated
		US26	625	Polished Chrome
		US26D	626	Satin Chrome
		BSP	—	Black Suede Powder Coat
		WSP	—	White Suede Powder Coat

MP-2 MULTI-POINT LOCKING HARDWARE

SARGENT®

7000 SERIES OPTIONS

ASSA ABLOY

USA & Canada Prices Effective May 1, 2021

Options	Description	Price
10	SARGENT Signature System	\$63.00 / cyl.
11	SARGENT XC Key System (not available with 10, 22, SC, SE options)	No addition
1160	Sargent XC Large Format Interchangeable Plastic Disposable Construction Core	No addition
1163	Sargent XC Large Format Interchangeable Core Cylinder - Includes masterkeying charges	\$83.00
1164	Sargent XC Large Format Interchangeable Construction Core Cylinder	\$83.00
1170	Small Format interchangeable disposable construction core - to accept 7 Pin XC permanent core	No addition
11727P	Small Format interchangeable keyed construction core - to accept 7 Pin XC permanent core	\$75.00
11737P	Small Format interchangeable core - to accept 7 pin XC permanent core	\$75.00
12	UL Fire Label Exit Devices (Not available on single door applications)	\$184.00
21	SARGENT Construction Key System (lost ball)	\$16.00 /cyl.
22	SARGENT Construction Key System (split key)	\$32.00 /cyl.
31	For doors up to 2-1/4"	No addition
	For doors over 2-1/4"	Consult Factory
	For doors over 2-1/4" or doors with panels	Consult Factory
36	6 Lobe security head screws	\$64.00
37	Spanner head screws	\$46.00
53	Top bolt monitoring switch	\$256.00
54	Monitor outside lever	\$232.00
55	Monitor inside lever	\$241.00
60	SARGENT Large Format Interchangeable Plastic Disposable Construction Core	No addition
63	SARGENT Large Format Interchangeable Core Cylinder includes master and grandmaster keying charge	\$83.00 /cyl.
64	SARGENT Large Format Interchangeable Construction Core Cylinder	\$83.00
6573	Small Format 6 Pin Uncombined Core	\$65.00 / cyl.
65737P	Small Format 7 Pin Uncombined Core	\$65.00 / cyl.
70	Small Format Interchangeable Disposable plastic Construction Core	No addition
72	Small Format Interchangeable 6-Pin Construction Core (7-pin with 11 option)	\$75.00
73	Small Format interchangeable core 6-pin Includes MK and GMK keying charges (Not available with J lever)	\$75.00
737P	Small Format interchangeable core 7-pin (refer to CK-12 for available keyways)	
	Includes MK and GMK keying charges (Not available with J lever)	\$75.00
75	Tactile Warning - Milled on backside of inside lever (Not available with Studio & Coastal Levers and the A Lever)	\$78.00
76	Tactile Warning - Milled on backside of outside lever (Not available with Studio & Coastal Levers and the A Lever)	\$78.00
77	Tactile Warning - Milled on backside of both levers (Not available with Studio & Coastal Levers and the A Lever)	\$156.00
F182	SARGENT Keso Security, patent pending, cylinder - new key systems	\$91.00 / cyl.
F183	SARGENT Keso Security, patent pending, removable core cylinder - new key systems	\$130.00 / cyl.
81	Cylinder to accept Keso (83) and Keso F1 (F183) Removable Core - no core provided	No addition
82	SARGENT Keso Security Cylinder (existing key systems only)	\$91.00 / cyl.
83	SARGENT Keso Security Removable Core Cylinder (existing key systems only)	\$130.00 / cyl.
84	SARGENT Keso Security Removable Construction Core Cylinder	See CK-18
85	Tactile Warning - Abrasive coating on inside lever	\$49.00
86	Tactile Warning - Abrasive coating on outside lever	\$49.00
87	Tactile Warning - Abrasive coating on both levers	\$98.00
88	Lever holdback	\$23.00
BR	SARGENT Bump Resistant Cyls. (N/A w/10, 22, 30, 60, 63, 64, 70, 72, 73, 737P, KESO, SC, SE)	\$25.00 /cyl.
CPC	Clear Powder Coat over 26D. All orders will continue to be handled as a "special" when CPC is ordered.	\$67.00
DG1	Patented Degree DG1 Key System	No addition
DG160	Hardware prepared for DG1-6300 Lg. Format IC cores, supplied with temporary plastic construction cores	No addition
DG163	Patented Degree DG1 Large Format Interchangeable Core Cylinder - Includes master keying charges	\$83.00
DG164	Hardware prepared for DG1-6300 Lg. Format IC cores, supplied with temporary keyed construction cores	\$83.00
DG2	Patented Degree DG2 Key System incorporating a locking sidebar	\$63.00/cyl.
DG260	Hardware prepared for DG2-6300 Lg. Format IC cores, supplied with temporary plastic construction cores	No addition
DG263	Patented Degree DG2 Large Format Interchangeable Core Cylinder - Includes master keying charges	\$146.00
DG264	Hardware prepared for DG2-6300 Lg. Format IC cores, supplied with temporary keyed construction cores	\$83.00
DG3	Patented Degree DG3 Key System incorporating a locking sidebar and UL437 listed	\$89.00/cyl.
DG360	Hardware prepared for DG3-6300 Lg. Format IC cores, supplied with temporary plastic construction cores	No addition
DG363	Patented Degree DG3 Large Format Interchangeable Core Cylinder - Includes master keying charges	\$172.00
DG364	Hardware prepared for DG3-6300 Lg. Format IC cores, supplied with temporary keyed construction cores	\$83.00
ELR	Electric Latch Retraction	\$852.00
HC	Hurricane Code	\$130.00
NB	No Bottom	No Addition
LC	Less Cylinder	-\$96.00/cyl.
SC	Schlage C Keyway Cylinder 0-Bitted (Rim and #41 Mortise Cylinder Only)	No addition
SE	Schlage E Keyway Cylinder 0-Bitted (Rim and #41 Mortise Cylinder Only)	No addition
SG	MicroShield® an antimicrobial powder coat (not available with 10B)	\$88.00
WS	Windstorm Certified	No Addition
	Concealed/Surface Vertical Rod Device - Over 96" to 120" Height	\$64.00

Experience a safer
and more open world

Copyright © 2002-2021 Sargent Manufacturing Company, an ASSA ABLOY Group company. All rights reserved.
Reproduction in whole or in part without the express written permission of Sargent Manufacturing Company is prohibited.
Contact us at: 800-727-5477 or visit www.sargentlock.com. In Canada contact us at: 800-461-3007 or visit www.assaabloydss.ca



Six Digit Function #:
 Series **70**
 Outside function **7001**
 Inside function **700106**

Please specify hand when ordering.

7000 Series-Vertical Rod Lock	
ER/ES/ET Control Standard Levers: A-B-E-F-J-L-P-W Coastal Levers: G-R-S-Y All Studio Collection Levers (Except Gramercy, Wooster Square, & Grant Park)	ER/ES/ET Control Gramercy Levers: RAG-RAL-RAM-RAS-RCM-REM-RGM Wooster Square Levers: H001-H002-H003-H004-H005-H006 Grant Park Levers: H007-H008-H009-H010-H011
Finishes listed below are for ET trim on both sides. Refer to catalog for available trims, trim finishes and how to order.	

7000 Series Function	Description	10BE/26D/BSP/WSP	03/04/09/10/10B/10BL/14/15/20D/26	Gramercy:10BE/BSP/WSP/629/630 Wstr Sq/Grant Park: 10BE/26D/BSP/WSP	03/04/09/10/10B/10BL/14/15/20D/26
700106	Blank plate x key operates ET				
700113	Blank plate x key lock/unlocks control				
700115	Blank plate x trim always operable				
700143	Blank plate x free wheeling key engages/disengages lever				
700146	Blank plate x free wheeling key operates ET				
700606	Key operates ET both sides				
700613	Key operates ET x key lock/unlocks control				
700615	Key operates ET x trim always operable				
701006	Dummy trim x key operates ET				
701013	Dummy trim x key lock/unlocks control	\$2,321.00	\$2,406.00	\$2,531.00	\$2,605.00
701015	Dummy trim (lever rigid) x trim always operable				
701306	Key lock/unlock control x key operates ET				
701313	Key lock/unlocks control both sides				
701315	Key locks/unlocks control x trim always operable				
701506	Trim always operable x key operates ET				
701513	Trim always operable x key lock/unlocks control				
701515	Trim always operable both sides				
701543	Trim always operable x fw key engages/disengages lever				
701546	Trim always operable x fw key operates ET				
701616	Classroom both sides				
7000 Series With Freewheeling Trim					
704043	Dummy trim x key engages/disengages lever				
704046	Dummy trim x key operates ET				
704315	Key engages/disengages Lever				
704340	Key engages/disengages lever x dummy trim				
704343	Key engages/disengages lever both sides	\$2,321.00	\$2,406.00	\$2,531.00	\$2,605.00
704346	Key engages/disengages lever x key operates ET				
704615	Key operates ET x trim always operable				
704640	Key operates ET x dummy trim				
704643	Key operates ET x key engages/disengages lever				
704646	Key operates ET on both sides				
Electromechanical					
*700173	Blank plate x fail safe				
*700174	Blank plate x fail secure				
*700673	Key operates ET x fail safe				
*700674	Key operates ET x fail secure				
*701073	Dummy trim x fail safe				
*701074	Dummy trim x fail secure				
*707306	Fail safe x key operates ET	\$2,514.00	\$2,598.00	\$2,726.00	\$2,800.00
*707313	Fail safe x key locks/unlocks control				
*707315	Fail safe x trim always operable				
*707406	Fail secure x key operates ET				
*707413	Fail secure x key locks/unlocks control				
*707415	Fail secure x trim always operable				
*707373	Fail safe both sides				
*707374	Fail safe x fail secure	\$2,710.00	\$2,796.00	\$2,920.00	\$2,994.00
*707473	Fail secure x fail safe				
*707474	Fail secure both sides				

*Specify voltage (12v or 24v) when ordering. **For Gramercy Series: 14, 15, 26, or 26D finishes are available on ET trim.

NOTES: 01, 10, 40, 73, & 74 outside functions are available with additional Auxiliary Control (106/113) Add \$760.00
 683 Kit for Single Door Application Requires 2 Kits (2 Pins/Kit)

Kit for Single Door Application – Requires 2 Kits (2 Pins/Kit)	Price
683 Thermal pin is not needed for double latching applications.	\$105.00

MP-4 MULTI-POINT LOCKING HARDWARE

SARGENT®

AD7000 SERIES OPTIONS

ASSA ABLOY

USA & Canada Prices Effective May 1, 2021

Options	Description	Price
10	SARGENT Signature System	\$63.00 / cyl.
11	SARGENT XC Key System (not available w/10, 10UL, 22, KESO)	No addition
1160	Sargent XC Large Format Interchangeable Plastic Disposable Construction Core	No addition
1163	Sargent XC Large Format Interchangeable Core Cylinder - Includes masterkeying charges	\$83.00
1164	Sargent XC Large Format Interchangeable Construction Core Cylinder	\$83.00
1170	Small Format interchangeable disposable construction core - to accept 7 Pin XC permanent core	No addition
11727P	Small Format interchangeable keyed construction core - to accept 7 Pin XC permanent core	\$75.00
11737P	Small Format interchangeable core - to accept 7 pin XC permanent core	\$75.00
21	SARGENT Construction Key System (lost ball)	\$16.00 /cyl.
22	SARGENT Construction Key System (split key)	\$32.00 /cyl.
31	For doors up to 2-1/4"	No addition
	For doors over 2-1/4"	Consult Factory
	For doors with panels	Consult Factory
36	6 Lobe security head screws	\$64.00
37	Spanner head screws	\$46.00
53	Top bolt monitoring switch	\$256.00
54	Monitor outside lever	\$232.00
55	Monitor inside lever	\$241.00
60	SARGENT Large Format Interchangeable Plastic Disposable Construction Core	No addition
63	SARGENT Large Format Interchangeable Core Cylinder includes master and grandmaster keying charge	\$83.00 /cyl.
64	SARGENT Large Format Interchangeable Construction Core Cylinder	\$83.00
6573	Small Format 6 Pin Uncombined Core	\$65.00 / cyl.
65737P	Small Format 7 Pin Uncombined Core	\$65.00 / cyl.
70	Small Format Interchangeable Disposable plastic Construction Core	No addition
72	Small Format Interchangeable 6-Pin Construction Core (7-pin with 11 option)	\$75.00
73	Small Format interchangeable core 6-pin Includes MK and GMK keying charges	\$75.00
737P	Small Format interchangeable core 7-pin (refer to CK-12 for available keyways) Includes MK and GMK keying charges	\$75.00
75	Tactile Warning - Milled on backside of inside lever (Not available with Studio & Coastal Levers and the A Lever)	\$78.00
76	Tactile Warning - Milled on backside of outside lever (Not available with Studio & Coastal Levers and the A Lever)	\$78.00
77	Tactile Warning - Milled on backside of both levers (Not available with Studio & Coastal Levers and the A Lever)	\$156.00
F182	SARGENT Keso Security, patent pending, cylinder – new key systems	\$91.00 / cyl.
F183	SARGENT Keso Security, patent pending, removable core cylinder – new key systems	\$130.00 / cyl.
81	Cylinder to accept Keso (83) and Keso F1 (F183) Removable Core – no core provided	No addition
82	SARGENT Keso Security Cylinder (existing key systems only)	\$91.00 / cyl.
83	SARGENT Keso Security Removable Core Cylinder (existing key systems only)	\$130.00 / cyl.
84	SARGENT Keso Security Removable Construction Core Cylinder	See CK-18
85	Tactile Warning - Abrasive coating on inside lever	\$49.00
86	Tactile Warning - Abrasive coating on outside lever	\$49.00
87	Tactile Warning - Abrasive coating on both levers	\$98.00
88	Lever holdback	\$23.00
BR	SARGENT Bump Resistant Cyls. (N/A w/10, 22, 30, 60, 63, 64, 70, 72, 73, 737P, KESO, SC, SE)	\$25.00 /cyl.
CPC	Clear Powder Coat over 26D. All orders will continue to be handled as a "special" when CPC is ordered.	\$67.00
DG1	Patented Degree DG1 Key System	No addition
DG160	Hardware prepared for DG1-6300 Lg. Format IC cores, supplied with temporary plastic construction cores	No addition
DG163	Patented Degree DG1 Large Format Interchangeable Core Cylinder - Includes master keying charges	\$83.00
DG164	Hardware prepared for DG1-6300 Lg. Format IC cores, supplied with temporary keyed construction cores	\$83.00
DG2	Patented Degree DG2 Key System incorporating a locking sidebar	\$63.00/cyl.
DG260	Hardware prepared for DG2-6300 Lg. Format IC cores, supplied with temporary plastic construction cores	No addition
DG263	Patented Degree DG2 Large Format Interchangeable Core Cylinder - Includes master keying charges	\$146.00
DG264	Hardware prepared for DG2-6300 Lg. Format IC cores, supplied with temporary keyed construction cores	\$83.00
DG3	Patented Degree DG3 Key System incorporating a locking sidebar and UL437 listed	\$89.00/cyl.
DG360	Hardware prepared for DG3-6300 Lg. Format IC cores, supplied with temporary plastic construction cores	No addition
DG363	Patented Degree DG3 Large Format Interchangeable Core Cylinder - Includes master keying charges	\$172.00
DG364	Hardware prepared for DG3-6300 Lg. Format IC cores, supplied with temporary keyed construction cores	\$83.00
ELR	Electric Latch Retraction	\$852.00
LC	Less Cylinder	-\$96.00/cyl.
NB	Less Bottom Bolt	No addition
SC	Schlage C Keyway Cylinder 0-Bitted (Rim and #41 Mortise Cylinder Only)	No addition
SE	Schlage E Keyway Cylinder 0-Bitted (Rim and #41 Mortise Cylinder Only)	No addition
SG	MicroShield® an antimicrobial powder coat (not available with 10B)	\$88.00
	Concealed/Surface Vertical Rod Device – Over 96" to 120" Height	\$64.00



Experience a safer
and more open world

Copyright © 2002-2021 Sargent Manufacturing Company, an ASSA ABLOY Group company. All rights reserved.
Reproduction in whole or in part without the express written permission of Sargent Manufacturing Company is prohibited.
Contact us at: 800-727-5477 or visit www.sargentlock.com. In Canada contact us at: 800-461-3007 or visit www.assaabloydss.ca



Six Digit Function #:
 Series **70**
 Outside function **7001**
 Inside function **700106**

Please specify hand when ordering.

AD7000 Series-Vertical Rod Lock	
ER/ES/ET Control  Standard Levers: A-B-E-F-J-L-P-W Coastal Levers: G-R-S-Y All Studio Collection Levers (Except Gramercy, Wooster Square, & Grant Park)	ER/ES/ET Control  Gramercy Levers: RAG-RAL-RAM-RAS-RCM-REM-RGM Wooster Square Levers: H001-H002-H003-H004-H005-H006 Grant Park Levers: H007-H008-H009-H010-H011
Finishes listed below are for ET trim on both sides. Refer to catalog for available trims, trim finishes and how to order.	

AD7000 Series Function	Description	10BE/26D/ BSP/WSP	03/04/09/ 10/10B/10BL/ 14/15/20D/26	Gramercy:10BE/BSP/ WSP/629/630 Wstr Sq/Grant Park: 10BE/26D/BSP/WSP	03/04/09/10/ 10B/10BL/14/ 15/20D/26
AD 700106	Blank plate x key operates ET				
AD 700113	Blank plate x key lock/unlocks control				
AD 700115	Blank plate x trim always operable				
AD 700143	Blank plate x free wheeling key engages/disengages lever				
AD 700146	Blank plate x free wheeling key operates ET				
AD 700606	Key operates ET both sides				
AD 700613	Key operates ET x key lock/unlocks control				
AD 700615	Key operates ET x trim always operable				
AD 701006	Dummy trim x key operates ET				
AD 701013	Dummy trim x key lock/unlocks control	\$2,321.00	\$2,406.00	\$2,531.00	\$2,605.00
AD 701015	Dummy trim (lever rigid) x trim always operable				
AD 701306	Key lock/unlock control x key operates ET				
AD 701313	Key lock/unlocks control both sides				
AD 701315	Key locks/unlocks control x trim always operable				
AD 701506	Trim always operable x key operates ET				
AD 701513	Trim always operable x key lock/unlocks control				
AD 701515	Trim always operable both sides				
AD 701543	Trim always operable x fw key engages/disengages lever				
AD 701546	Trim always operable x fw key operates ET				
AD 701616	Classroom both sides				
AD7000 Series With Freewheeling Trim					
AD 704043	Dummy trim x key engages/disengages lever				
AD 704046	Dummy trim x key operates ET				
AD 704315	Key engages/disengages Lever				
AD 704340	Key engages/disengages lever x dummy trim				
AD 704343	Key engages/disengages lever both sides	\$2,321.00	\$2,406.00	\$2,531.00	\$2,605.00
AD 704346	Key engages/disengages lever x key operates ET				
AD 704615	Key operates ET x trim always operable				
AD 704640	Key operates ET x dummy trim				
AD 704643	Key operates ET x key engages/disengages lever				
AD 704646	Key operates ET on both sides				
Electromechanical					
AD *700173	Blank plate x fail safe				
AD *700174	Blank plate x fail secure				
AD *700673	Key operates ET x fail safe				
AD *700674	Key operates ET x fail secure				
AD *701073	Dummy trim x fail safe				
AD *701074	Dummy trim x fail secure				
AD *707306	Fail safe x key operates ET	\$2,514.00	\$2,598.00	\$2,726.00	\$2,800.00
AD *707313	Fail safe x key locks/unlocks control				
AD *707315	Fail safe x trim always operable				
AD *707406	Fail secure x key operates ET				
AD *707413	Fail secure x key locks/unlocks control				
AD *707415	Fail secure x trim always operable				
AD *707373	Fail safe both sides				
AD *707374	Fail safe x fail secure	\$2,710.00	\$2,796.00	\$2,920.00	\$2,994.00
AD *707473	Fail secure x fail safe				
AD *707474	Fail secure both sides				

*Specify voltage (12v or 24v) when ordering.

**For Gramercy Series: 14, 15, 26, or 26D finishes are available on ET trim.

NOTES: 01, 10, 40, 73, & 74 outside functions are available with additional Auxiliary Control (106/113)

Add \$760.00

MP-6 MULTI-POINT LOCKING HARDWARE

SARGENT®

WD7000 SERIES OPTIONS

ASSA ABLOY

USA & Canada Prices Effective May 1, 2021

Options	Description	Price
10	SARGENT Signature System	\$63.00 / cyl.
11	SARGENT XC Key System (not available w/10, 10UL, 22, KESO)	No addition
1160	Sargent XC Large Format Interchangeable Plastic Disposable Construction Core	No addition
1163	Sargent XC Large Format Interchangeable Core Cylinder - Includes masterkeying charges	\$83.00
1164	Sargent XC Large Format Interchangeable Construction Core Cylinder	\$83.00
1170	Small Format interchangeable disposable construction core - to accept 7 Pin XC permanent core	No addition
11727P	Small Format interchangeable keyed construction core - to accept 7 Pin XC permanent core	\$75.00
11737P	Small Format interchangeable core - to accept 7 pin XC permanent core	\$75.00
12	UL Fire Label Exit Devices (Not available on single door applications)	\$184.00
21	SARGENT Construction Key System (lost ball)	\$16.00 /cyl.
22	SARGENT Construction Key System (split key)	\$32.00 /cyl.
31	For doors up to 2-1/4"	No addition
	For doors over 2-1/4"	Consult Factory
	For doors with panels	Consult Factory
36	6 Lobe security head screws	\$64.00
37	Spanner head screws	\$46.00
53	Top bolt monitoring switch	\$256.00
54	Monitor outside lever	\$232.00
55	Monitor inside lever	\$241.00
60	SARGENT Large Format Interchangeable Plastic Disposable Construction Core	No addition
63	SARGENT Large Format Interchangeable Core Cylinder includes master and grandmaster keying charge	\$83.00 /cyl.
64	SARGENT Large Format Interchangeable Construction Core Cylinder	\$83.00
6573	Small Format 6 Pin Uncombined Core	\$65.00 / cyl.
65737P	Small Format 7 Pin Uncombined Core	\$65.00 / cyl.
70	Small Format Interchangeable Disposable plastic Construction Core	No addition
72	Small Format Interchangeable 6-Pin Construction Core (7-pin with 11 option)	\$75.00
73	Small Format interchangeable core 6-pin Includes MK and GMK keying charges	\$75.00
737P	Small Format interchangeable core 7-pin (refer to CK-12 for available keyways) Includes MK and GMK keying charges	\$75.00
75	Tactile Warning - Milled on backside of inside lever (Not available with Studio & Coastal Levers and the A Lever)	\$78.00
76	Tactile Warning - Milled on backside of outside lever (Not available with Studio & Coastal Levers and the A Lever)	\$78.00
77	Tactile Warning - Milled on backside of both levers (Not available with Studio & Coastal Levers and the A Lever)	\$156.00
F182	SARGENT Keso Security, patent pending, cylinder – new key systems	\$91.00 / cyl.
F183	SARGENT Keso Security, patent pending, removable core cylinder – new key systems	\$130.00 / cyl.
81	Cylinder to accept Keso (83) and Keso F1 (F183) Removable Core – no core provided	No addition
82	SARGENT Keso Security Cylinder (existing key systems only)	\$91.00 / cyl.
83	SARGENT Keso Security Removable Core Cylinder (existing key systems only)	\$130.00 / cyl.
84	SARGENT Keso Security Removable Construction Core Cylinder	See CK-18
85	Tactile Warning - Abrasive coating on inside lever	\$49.00
86	Tactile Warning - Abrasive coating on outside lever	\$49.00
87	Tactile Warning - Abrasive coating on both levers	\$98.00
88	Lever holdback	\$23.00
BR	SARGENT Bump Resistant Cyls. (N/A w/10, 22, 30, 60, 63, 64, 70, 72, 73, 737P, KESO, SC, SE)	\$25.00/cyl.
CPC	Clear Powder Coat over 26D. All orders will continue to be handled as a "special" when CPC is ordered.	\$67.00
DG1	Patented Degree DG1 Key System	No addition
DG160	Hardware prepared for DG1-6300 Lg. Format IC cores, supplied with temporary plastic construction cores	No addition
DG163	Patented Degree DG1 Large Format Interchangeable Core Cylinder - Includes master keying charges	\$83.00
DG164	Hardware prepared for DG1-6300 Lg. Format IC cores, supplied with temporary keyed construction cores	\$83.00
DG2	Patented Degree DG2 Key System incorporating a locking sidebar	\$63.00/cyl.
DG260	Hardware prepared for DG2-6300 Lg. Format IC cores, supplied with temporary plastic construction cores	No addition
DG263	Patented Degree DG2 Large Format Interchangeable Core Cylinder - Includes master keying charges	\$146.00
DG264	Hardware prepared for DG2-6300 Lg. Format IC cores, supplied with temporary keyed construction cores	\$83.00
DG3	Patented Degree DG3 Key System incorporating a locking sidebar and UL437 listed	\$89.00/cyl.
DG360	Hardware prepared for DG3-6300 Lg. Format IC cores, supplied with temporary plastic construction cores	No addition
DG363	Patented Degree DG3 Large Format Interchangeable Core Cylinder - Includes master keying charges	\$172.00
DG364	Hardware prepared for DG3-6300 Lg. Format IC cores, supplied with temporary keyed construction cores	\$83.00
ELR	Electric Latch Retraction	\$852.00
LC	Less Cylinder	-\$96.00/cyl.
NB	Less Bottom Bolt	No addition
SC	Schlage C Keyway Cylinder 0-Bitted (Rim and #41 Mortise Cylinder Only)	No addition
SE	Schlage E Keyway Cylinder 0-Bitted (Rim and #41 Mortise Cylinder Only)	No addition
SG	MicroShield® an antimicrobial powder coat (not available with 10B)	\$88.00
	Concealed/Surface Vertical Rod Device – Over 96" to 120" Height	\$64.00



Experience a safer
and more open world

Copyright © 2002-2021 Sargent Manufacturing Company, an ASSA ABLOY Group company. All rights reserved.
Reproduction in whole or in part without the express written permission of Sargent Manufacturing Company is prohibited.
Contact us at: 800-727-5477 or visit www.sargentlock.com. In Canada contact us at: 800-461-3007 or visit www.assaabloydss.ca



Six Digit Function #:
 Series **70**
 Outside function **7001**
 Inside function **700106**

Please specify hand when ordering.

WD7000 Series-Vertical Rod Lock	
ER/ES Control  Standard Levers: A-B-E-F-J-L-P-W Coastal Levers: G-R-S-Y All Studio Collection Levers (Except Gramercy, Wooster Square, & Grant Park)	ER/ES Control  Gramercy Levers: RAG-RAL-RAM-RAS-RCM-REM-RGM Wooster Square Levers: H001-H002-H003-H004-H005-H006 Grant Park Levers: H007-H008-H009-H010-H011
Finishes listed below are for ET trim on both sides. Refer to catalog for available trims, trim finishes and how to order.	

WD7000 Series Function	Description	10BE/26D/ BSP/WSP	03/04/09/ 10/10B/10BL/ 14/15/20D/26	Gramercy:10BE/BSP/ WSP/629/630 Wstr Sq/Grant Park: 10BE/26D/BSP/WSP	03/04/09/10/ 10B/10BL/14/ 15/20D/26
WD 700106	Blank plate x key operates ER/ES				
WD 700113	Blank plate x key lock/unlocks control				
WD 700115	Blank plate x trim always operable				
WD 700143	Blank plate x free wheeling key engages/disengages lever				
WD 700146	Blank plate x free wheeling key operates ER/ES				
WD 700606	Key operates ER/ES both sides				
WD 700613	Key operates ER/ES x key lock/unlocks control				
WD 700615	Key operates ER/ES x trim always operable				
WD 701006	Dummy trim x key operates ER/ES				
WD 701013	Dummy trim x key lock/unlocks control	\$2,321.00	\$2,406.00	\$2,531.00	\$2,605.00
WD 701015	Dummy trim (lever rigid) x trim always operable				
WD 701306	Key lock/unlock control x key operates ER/ES				
WD 701313	Key lock/unlocks control both sides				
WD 701315	Key locks/unlocks control x trim always operable				
WD 701506	Trim always operable x key operates ER/ES				
WD 701513	Trim always operable x key lock/unlocks control				
WD 701515	Trim always operable both sides				
WD 701543	Trim always operable x fw key engages/disengages lever				
WD 701546	Trim always operable x fw key operates ER/ES				
WD 701616	Classroom both sides				
WD7000 Series With Freewheeling Trim					
WD 704043	Dummy trim x key engages/disengages lever				
WD 704046	Dummy trim x key operates ER/ES				
WD 704315	Key engages/disengages Lever				
WD 704340	Key engages/disengages lever x dummy trim				
WD 704343	Key engages/disengages lever both sides	\$2,321.00	\$2,406.00	\$2,531.00	\$2,605.00
WD 704346	Key engages/disengages lever x key operates ER/ES				
WD 704615	Key operates ER/ES x trim always operable				
WD 704640	Key operates ER/ES x dummy trim				
WD 704643	Key operates ER/ES x key engages/disengages lever				
WD 704646	Key operates ER/ES on both sides				
Electromechanical					
WD *700173	Blank plate x fail safe				
WD *700174	Blank plate x fail secure				
WD *700673	Key operates ET x fail safe				
WD *700674	Key operates ET x fail secure				
WD *701073	Dummy trim x fail safe				
WD *701074	Dummy trim x fail secure				
WD *707306	Fail safe x key operates ER/ES	\$2,514.00	\$2,598.00	\$2,726.00	\$2,800.00
WD *707313	Key lock/unlock control both sides				
WD *707315	Fail safe x trim always operable				
WD *707406	Fail secure x key operates ER/ES				
WD *707413	Fail secure x key locks/unlocks control				
WD *707415	Fail secure x trim always operable				
WD *707373	Fail safe both sides				
WD *707374	Fail safe x fail secure	\$2,710.00	\$2,796.00	\$2,920.00	\$2,994.00
WD *707473	Fail secure x fail safe				
WD *707474	Fail secure both sides				

*Specify voltage (12v or 24v) when ordering.

**For Gramercy Series: 14, 15, 26, or 26D finishes are available on ET trim.

NOTES: 01, 10, 40, 73, & 74 outside functions are available with additional Auxiliary Control (106/113)

Add \$760.00

Experience a safer
and more open world

MP-8 MULTI-POINT LOCKING HARDWARE

SARGENT®

ER/ES/ET LEVER CONTROL TRIM

ASSA ABLOY

USA & Canada Prices Effective May 1, 2021

ER/ES/ET Control

Standard Levers:
A-B-E-F-J-L-P-W

Coastal Levers:
G-R-S-Y

All Studio Collection Levers
(Except Gramercy, Wooster Square,
& Grant Park)



All Trim is priced with cylinder where required.

Refer to catalog for available trims, trim finishes and how to order.

WD7000 Series is only available with ER and ES trim.

NOTE: Must specify MP- option when ordering 700 Series Inside Lever Type Trims

700 Series ER/ES/ET Lever Type Trim Function Series (Available as Listed)		Finish
TRIM#	FUNCTION	03/04/09/10/10B/10BE/10BL/ 14/15/20D/26/26D/BSP/WSP
701-2	01 Blank case	
706-2	06 Key operates	
710-2	10 Dummy trim lever rigid	\$760.00
713-2	13 Key locks/unlocks control	
715-2	15 Trim always operable	
716-2	16 classroom	
773-2	73 Fail Safe	\$1,072.00
774-2	74 Fail Secure	
700 Series Freewheeling ER/ES/ET Lever Type Trim Function Series (Available as Listed)		Finish
TRIM#	FUNCTION	03/04/09/10/10B/10BE/10BL/ 14/15/20D/26/26D/BSP/WSP
740-2	40 Dummy trim (lever rotates)	
743-2	43 Key engages/disengages lever	\$760.00
746-2	46 Key operates control	

Experience a safer
and more open world

Copyright © 2002-2021 Sargent Manufacturing Company, an ASSA ABLOY Group company. All rights reserved.
Reproduction in whole or in part without the express written permission of Sargent Manufacturing Company is prohibited.
Contact us at: 800-727-5477 or visit www.sargentlock.com. In Canada contact us at: 800-461-3007 or visit www.assaabloydss.ca

ER/ES/ET LEVER CONTROL TRIM GRAMERCY SERIES DESIGN

USA & Canada Prices Effective May 1, 2021

ER/ES/ET Control

Gramercy Levers:
RAG-RAL-RAM-RAS-
RCM-REM-RGM

Wooster Square Levers:
H001-H002-H003-H004-H005-H006

Grant Park Levers:
H007-H008-H009-H010-H011



Shown:
ETRAM



Shown:
ERRAM



Shown:
ESRAM

All Exit Trim is priced with cylinder where required.

Refer to catalog for available trims, trim finishes and how to order.

WD7000 Series is only available with ER and ES trim.

NOTE: Must specify MP- option when ordering 700 Series Inside Lever Type Trims

700 Series ER/ES/ET Lever Type Trim Function Series (Available as Listed)		03/04/09/10/10B/ 10BE/10BL/14/15/20D/ 26/26D/BSP/WSP/629*/630*
TRIM#	FUNCTION	
701-2	01 Blank case	
706-2	06 Key operates	
710-2	10 Dummy trim lever rigid	\$1,003.00
713-2	13 Key locks/unlocks control	
715-2	15 Trim always operable	
716-2	16 classroom	
773-2	73 Fail safe	\$1,265.00
774-2	74 Fail secure	
700 Series Freewheeling ER/ES/ET Lever Type Trim Function Series (Available as Listed)		03/04/09/10/10B/ 10BE/10BL/14/15/20D/ 26/26D/BSP/WSP/629*/630*
TRIM#	FUNCTION	
740-2	40 Dummy trim (lever rotates)	
743-2	43 Key engages/disengages lever	\$1,003.00
746-2	46 Key operates control	

*Not available with Wooster Square and Grant Park Levers.

MP-10 MULTI-POINT LOCKING HARDWARE

SARGENT®

ASSA ABLOY

ROD REPLACEMENT, 7000 STRIKES, LOCKING SLIDE, AND SPINDLE KITS

USA & Canada Prices Effective May 1, 2021

Top Rod & Bolt Kits (Door & mounting height are required)		
Part	Description	Price
MD694T	7000	
WD694T	WD-7000	\$95.00
WDA694T	WD-7000 x AUX	
Bottom Rod & Bolt Kits (Mounting height is required)		
694B	7000, WD-7000,WD-7000 x Aux	\$74.00
Top Rod Kits (Door & mounting height are required)		
MD663T	7000	
WD663T	WD-7000	\$54.00
WDA663T	WD-7000 x AUX	
Bottom Rod Kit (Mounting height is required)		
663B	7000, WD-7000,WD-7000 x Aux	\$48.00
Strikes Parts		
606	Bottom Strike Pack	\$65.15
650	Top Strike Pack	\$38.31
Locking Slide Replacement Kit		
607-1	Locking Slide Replacement Kit (713)	\$120.00
607-2	Locking Slide Replacement Kit (706)	\$120.00

Experience a safer
and more open world

Copyright © 2002-2021 Sargent Manufacturing Company, an ASSA ABLOY Group company. All rights reserved.
Reproduction in whole or in part without the express written permission of Sargent Manufacturing Company is prohibited.
Contact us at: 800-727-5477 or visit www.sargentlock.com. In Canada contact us at: 800-461-3007 or visit www.assaabloydss.ca

USA & Canada Prices Effective May 1, 2021

Part #	Description	Price
01-0696	Spirol Pin	\$1.07
01-1027	Extension Connector	\$0.95
01-1182	Cap Screw	\$2.65
01-1183	Machine Screw PH Truss Head	\$0.73
01-1479	#10-32 x .500 PH FL HD MH Screw	\$0.21
01-4383	Machine Screw	0.54
01-4410	#4-40 UNC-2A X 1/4 Screw	\$0.21
01-4451	Thru Bolt 1/4-20 x 2-3/8" (1-3/4" door)	\$1.86
01-4468	Thru Bolt 1/4-20 x 3" (1-3/4" door)	\$1.64
01-4507	Groove Pin Double Headed	\$0.62
01-4560	#3-48 x .125 PH RD HD Machine Screw	\$0.89
01-9105	Tooth Lock Washer	\$0.06
68-0888	Bottom Plate	\$13.89
68-1270	Extension Connector	\$30.78
68-1286	Top Rod Extension	\$35.61
68-1393	Retainer Plate	\$9.27
68-3627	Inner Case Assy (12-)	\$397.35
68-3677	Screw Pack	\$18.29
68-4840	Latch Bolt Assy	\$38.67
68-5374	Top Case Assy (Standard)	\$219.80
68-7546	Motor Actuator Assy	\$110.81
82-0184	Cap Nut	\$7.86
94-2008	Inner Case Assy (STD)	\$290.98
94-2414	Inner Case Assy (12-, 53-)	\$751.97
94-2423	Inner Case Assy (WD)	\$290.98
94-2424	Inner Case Assy (53-WD)	\$563.26
97-0347	Locking Slide Spring	\$6.30
97-0350	Collar	\$18.24
97-0425	Hub Spring	\$11.20
97-0475	Locking Slide	\$60.39
97-0476	Locking Slide	\$70.60
97-0477	Bushing Insert	\$8.98
97-0478	Lower Hub Plate	\$5.57
97-0479	Spindle Lock	\$37.63
97-0522	Lower Hub Plate	\$2.43
97-0528	Locking Piece	\$2.84
97-0557	Fusable Link	\$0.28
97-0566	Hub Spring (J Lever Only)	\$11.20
97-0571	Locking Slide Spring	\$0.81
97-0573	Spindle	\$7.48
97-0581	Retaining Plate	\$3.58
97-0582	Spacer	\$2.23
97-0603	Cam	\$5.81
97-3098	Spindle Assy	\$49.18

MP-12 MULTI-POINT LOCKING HARDWARE

SARGENT®

FM6100 OPTIONS

ASSA ABLOY

USA & Canada Prices Effective May 1, 2021

Options	Description	Price
10	SARGENT Signature System	\$63.00 / cyl.
11	SARGENT XC Key System (not available with 10, 22, SC, SE options)	No addition
1160	Sargent XC Large Format Interchangeable Plastic Disposable Construction Core	No addition
1163	Sargent XC Large Format Interchangeable Core Cylinder - Includes masterkeying charges	\$83.00
1164	Sargent XC Large Format Interchangeable Construction Core Cylinder	\$83.00
1170	Small Format interchangeable disposable construction core - to accept 7 Pin XC permanent core	No addition
11727P	Small Format interchangeable keyed construction core - to accept 7 Pin XC permanent core	\$75.00
11737P	Small Format interchangeable core - to accept 7 pin XC permanent core	\$75.00
21	SARGENT Construction Key System (lost ball) Standard on new systems est. since 5/1/96	\$16.00 /cyl.
22	Construction Key System (split key) To be used on pre-established split key systems only	\$32.00 /cyl.
36	6 Lobe security head screws	\$64.00
60	SARGENT Large Format Interchangeable Plastic Disposable Construction Core	No addition
63	SARGENT Large Format Interchangeable Core Cylinder includes master and grandmaster keying charge	\$83.00 /cyl.
64	SARGENT Large Format Interchangeable Construction Core Cylinder	\$83.00
6573	Small Format 6 Pin Uncombined Core	\$65.00 / cyl.
65737P	Small Format 7 Pin Uncombined Core	\$65.00 / cyl.
70	Small Format interchangeable disposable plastic construction core (Not available with J lever)	No addition
72	Small Format interchangeable 6-Pin construction core (not available with J lever)	\$75.00
73	Small Format interchangeable core 6-pin Includes MK and GMK keying charges (Not available with J lever)	\$75.00
737P	Small Format interchangeable core 7-pin (refer to CK-12 for available keyways) Includes MK and GMK keying charges (Not available with J lever)	\$75.00
75	Tactile Warning - Milled on backside of inside lever (Not available with Studio & Coastal Levers and the A Lever)	\$78.00
76	Tactile Warning - Milled on backside of outside lever (Not available with Studio & Coastal Levers and the A Lever)	\$78.00
77	Tactile Warning - Milled on backside of both levers (Not available with Studio & Coastal Levers and the A Lever)	\$156.00
F182	SARGENT Keso Security, patent pending, cylinder – new key systems	\$91.00 / cyl.
F183	SARGENT Keso Security, patent pending, removable core cylinder – new key systems	\$130.00 / cyl.
81	Cylinder to accept Keso (83) and Keso F1 (F183) Removable Core – no core provided	No Addition
82	SARGENT Keso Security Cylinder (existing key systems only)	\$91.00 / cyl.
83	SARGENT Keso Security Removable Core Cylinder (existing key systems only)	\$130.00 / cyl.
84	SARGENT Keso Security Removable Construction Core Cylinder	See page CK-18
85	Tactile Warning - Abrasive coating on inside lever	\$49.00
86	Tactile Warning - Abrasive coating on outside lever	\$49.00
87	Tactile Warning - Abrasive coating on both levers	\$98.00
BR	SARGENT Bump Resistant Cyls. (N/A w/10, 22, 30, 60, 63, 64, 70, 72, 73, 737P, KESO, SC, SE)	\$25.00 /cyl.
CPC	Clear Powder Coat over 26D. All orders will continue to be handled as a "special" when CPC is ordered.	\$67.00
DG1	Patented Degree DG1 Key System	No addition
DG160	Hardware prepared for DG1-6300 Lg. Format IC cores, supplied with temporary plastic construction cores	No addition
DG163	Patented Degree DG1 Large Format Interchangeable Core Cylinder - Includes master keying charges	\$83.00
DG164	Hardware prepared for DG1-6300 Lg. Format IC cores, supplied with temporary keyed construction cores	\$83.00
DG2	Patented Degree DG2 Key System incorporating a locking sidebar	\$63.00/cyl.
DG260	Hardware prepared for DG2-6300 Lg. Format IC cores, supplied with temporary plastic construction cores	No addition
DG263	Patented Degree DG2 Large Format Interchangeable Core Cylinder - Includes master keying charges	\$146.00
DG264	Hardware prepared for DG2-6300 Lg. Format IC cores, supplied with temporary keyed construction cores	\$83.00
DG3	Patented Degree DG3 Key System incorporating a locking sidebar and UL437 listed	\$89.00/cyl.
DG360	Hardware prepared for DG3-6300 Lg. Format IC cores, supplied with temporary plastic construction cores	No addition
DG363	Patented Degree DG3 Large Format Interchangeable Core Cylinder - Includes master keying charges	\$172.00
DG364	Hardware prepared for DG3-6300 Lg. Format IC cores, supplied with temporary keyed construction cores	\$83.00
LC	Less Cylinder	-\$96.00/cyl.
SC	Schlage C Keyway Cylinder 0-Bitted (Rim and #41 Mortise Cylinder Only)	No Addition
SE	Schlage E Keyway Cylinder 0-Bitted (Rim and #41 Mortise Cylinder Only)	No Addition
SG	MicroShield® an antimicrobial powder coat	\$88.00

Experience a safer
and more open world

Copyright © 2002-2021 Sargent Manufacturing Company, an ASSA ABLOY Group company. All rights reserved.
Reproduction in whole or in part without the express written permission of Sargent Manufacturing Company is prohibited.
Contact us at: 800-727-5477 or visit www.sargentlock.com. In Canada contact us at: 800-461-3007 or visit www.assaabloydss.ca

USA & Canada Prices Effective May 1, 2021

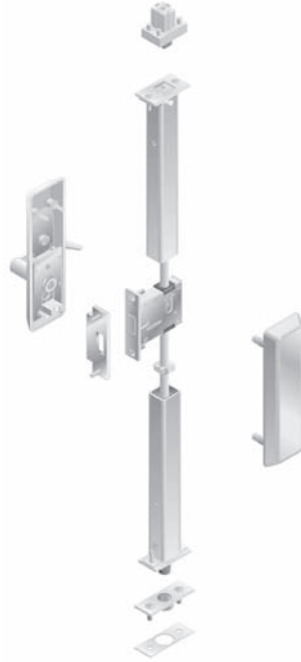

Please specify hand when ordering.

FM6100 Series – Storm Shutter Multi-Point Auto Deadlocking System



ECL



ECMH

Escutcheon: EC Control

Lever A-B-E-F-J-L-P-W
Coastal Series Y-G-R-S
All Studio Collection Levers (Except Gramercy,
Wooster Square, & Grant Park)

Finishes listed below are for ET trim on both sides. Refer to catalog for available trims, trim finishes and how to order.

			Finish	
FM6100 Series Option	Function	Description	10BE/26D/ BSP/WSP	03/04/09/10/10B/ 10BL/14/15/20D/26
FM	6101	Passage Lever x Blank Plate		
FM	6113	Classroom	\$4,029.00	\$4,042.00
FM	6115	Passage or Closet		
700 Series Inside EC Control Lever Type Trim			03/04/09/10/10B/10BE/10BL/ 14/15/20D/26/26D	
Option	Function	Description		
MP	715-3	Used with all available outside functions		\$1,238.00
700 Series EC Lever Type Trim			03/04/09/10/10B/10BE/10BL/ 14/15/20D/26/26D	
Trim #	Function			
701-3	6101			
713-3	6113			\$1,238.00
715-3	6115			

How to order: Trim# x EC Control x Lever Design x Finish x Hand

Example: 701-3 x ECL x 26D x RH

MP-14 MULTI-POINT LOCK

SARGENT®

7300, FM7300, & BL7300 SERIES OPTIONS

ASSA ABLOY

USA & Canada Prices Effective May 1, 2021

Options	Description	Price
3	Stainless steel hub	\$69.00
10	SARGENT Signature Key System	\$63.00 / cyl.
11†	SARGENT XC Key System (not available w/10, KESO, SC, SE)	No addition
1160	SARGENT XC Large Format Interchangeable Plastic Disposable Construction Core	No addition
1163	SARGENT XC Large Format Interchangeable Core Cylinder - Includes masterkeying charges	\$83.00
1164	SARGENT XC Large Format Interchangeable Construction Core Cylinder	\$83.00
1170	Small Format interchangeable disposable construction core - to accept 7 Pin XC permanent core	No addition
11727P	Small Format interchangeable keyed construction core - to accept 7 Pin XC permanent core	\$75.00
11737P	Small Format interchangeable core - to accept 7 pin XC permanent core	\$75.00 / cyl.
21†	SARGENT Construction Key System (lost ball) Standard on all new systems established since 5/1/96	\$16.00 / cyl.
22†	SARGENT Construction Key System (split key) To be used on pre-established split key systems only	\$32.00 / cyl.
36	6 Lobe security head screws	\$64.00
49	Occupancy Indicator with emergency Release	\$140.00
50	Secured Indicator Rose – Available with 24 and 25 functions only	\$140.00
60	SARGENT Large Format Interchangeable Plastic Disposable Construction Core	No addition
63	SARGENT Large Format Interchangeable core cylinder, includes master keying charges	\$83.00 / cyl
64	SARGENT Large Format Interchangeable Construction Core Cylinder	\$83.00
6573†	Small Format 6-Pin Uncombined Core (Refer to CK-12)	\$65.00 / cyl.
65737P†	Small Format 7-Pin Uncombined Core (Refer to CK-12)	\$65.00 / cyl.
70†	Small Format interchangeable disposable plastic construction core	No addition
72†	Small Format interchangeable 6-Pin construction core	\$75.00
73†	Small Format interchangeable core 6-pin Includes MK and GMK keying charges	\$75.00 / cyl
737P†	Small Format interchangeable core 7-pin (refer to CK-12 for available keyways) Includes MK and GMK keying charges	\$75.00 / cyl
75	Tactile Warning - Milled Inside Lever	\$78.00
76	Tactile Warning - Milled Outside Lever	\$78.00
77	Tactile Warning - Milled Outside and Inside Lever	\$156.00
81†	Cylinder to accept Keso (83) and Keso F1 (F183) removable core – no core provided	No addition
F182†	SARGENT Keso Security Cylinder – patented – new key systems	\$91.00 / cyl.
F183†	SARGENT Keso Security Removable Core Cylinder – patented – new key systems	\$130.00 / cyl.
82†	SARGENT Keso Security Cylinder (For existing systems only)	\$91.00 / cyl.
83†	SARGENT Keso Security Removable Core Cylinder (For existing systems only)	\$130.00 / cyl.
84†	SARGENT Keso Security Removable Construction Core Cylinder	See CK-18
85	Tactile Warning - Abrasive Coating on Inside Lever	\$49.00
86	Tactile Warning - Abrasive Coating on Outside Lever	\$49.00
87	Tactile Warning - Abrasive Coating on Outside & Inside Lever	\$98.00
BR	SARGENT Bump Resistant Cylinders (N/A w/10, 22, 30, 60, 63, 64, 70, 72, 73, 737P, KESO, SC, & SE options)	\$25.00 /cyl.
DX	Deadbolt Monitoring	\$197.00
DG1	Patented Degree DG1 Key System	No addition
DG160	Hardware prepared for DG1-6300 Lg. Format IC cores, supplied with temporary plastic construction cores	No addition
DG163	Patented Degree DG1 Large Format Interchangeable Core Cylinder - Includes master keying charges	\$83.00
DG164	Hardware prepared for DG1-6300 Lg. Format IC cores, supplied with temporary keyed construction cores	\$83.00
DG2	Patented Degree DG2 Key System incorporating a locking sidebar	\$63.00/cyl.
DG260	Hardware prepared for DG2-6300 Lg. Format IC cores, supplied with temporary plastic construction cores	No addition
DG263	Patented Degree DG2 Large Format Interchangeable Core Cylinder - Includes master keying charges	\$146.00
DG264	Hardware prepared for DG2-6300 Lg. Format IC cores, supplied with temporary keyed construction cores	\$83.00
DG3	Patented Degree DG3 Key System incorporating a locking sidebar and UL437 listed	\$89.00/cyl.
DG360	Hardware prepared for DG3-6300 Lg. Format IC cores, supplied with temporary plastic construction cores	No addition
DG363	Patented Degree DG3 Large Format Interchangeable Core Cylinder - Includes master keying charges	\$172.00
DG364	Hardware prepared for DG3-6300 Lg. Format IC cores, supplied with temporary keyed construction cores	\$83.00
LB	Extra large thumbturn	\$18.00
LC	Less Cylinder	-\$96.00/cyl.
SC†	Schlage "C" Keyway cylinder, (Number 41 Cylinder Only, 0 bitted)	No addition
SE†	Schlage "E" Keyway cylinder, (Number 41 Cylinder Only, 0 bitted)	No addition
SG	MicroShield® – an antimicrobial powder coat finish	\$88.00
T1	Decorative thumbturn; backplate matches rose design chosen	No Addition
T2	Decorative square thumbturn; backplate matches rose design chosen	No Addition
T3	Decorative cylinder thumbturn; backplate matches rose design chosen	No Addition

NOTES: † Not avail. with 60, 63, 64 options

CPC Clear Powder Coat over 26D/32D \$67.00
All orders will continue to be handled as a "special" when CPC is ordered.

Experience a safer
and more open world

Copyright © 2002-2021 Sargent Manufacturing Company, an ASSA ABLOY Group company. All rights reserved.
Reproduction in whole or in part without the express written permission of Sargent Manufacturing Company is prohibited.
Contact us at: 800-727-5477 or visit www.sargentlock.com. In Canada contact us at: 800-461-3007 or visit www.assaabloydss.ca

ASSA ABLOY

7300, FM7300, & BL7300 SERIES

USA & Canada Prices Effective May 1, 2021



7300, FM7300, & BL7300 SERIES

Standard Rose Designs: O, E, L, LN

Standard Lever Designs: A, B, E, F, J, L, P, W

Studio Rose Designs: E2, E3, E4, CO, TO, CR, TR, LN, O

Studio Collection Levers Except for Gramercy, Wooster Square, & Grant Park

For Gramercy, Wooster Square, & Grant Park Levers

– Add \$138.00 to below prices.

Please specify hand when ordering.

Finishes listed below are for ET trim on both sides.

Refer to catalog for available trims, trim finishes and how to order.

Series	Description	Price
FM	FM7300 Fema	\$400.00
BL	BL7300 Blast	\$800.00

*FM7300 and BL7300 are only available with 7318, 7324, 7325, 7301, 7366, 7368, 7326, 7339, 7340, 7341, 7349, 73280/81/84/85 functions

		Finish	
Single Cylinder without Deadbolt		10BE/26D BSP/WSP	03/04/09/10/10B/10BL 14/15/20D/26/32/32D
7305	Office/Entry		
7337	Classroom		
7356	Office & Inner Entry Lock	\$3,700.00	\$3,723.00
7389	Holdback		
Single Cylinder with Deadbolt			
Function	Description		
7318*	Classroom		
7324*	Storeroom	\$3,700.00	\$3,723.00
7325*	Exit/Dormitory		
7327	Closet or Storeroom		
Non-Keyed			
Function	Description		
7301*	Inside Passage		
7314	Passage		
7366*	Privacy Bath	\$3,700.00	\$3,723.00
7368*	Privacy Bedroom		
7319	Passage or Closet		
7365	Privacy Bath/Bedroom		
Double Cylinder with Deadbolt			
Function	Description		
7326*	Store Door		
7339*	Classroom Security Intruder Deadbolt		
7340*	Classroom Security Intruder Auxiliary Deadbolt	\$3,700.00	\$3,723.00
7341*	Classroom Security Intruder Deadlatch		
7349*	Security Deadbolt		
Double Cylinder without Deadbolt			
Function	Description		
7338	Classroom Security Intruder Latchbolt	\$3,700.00	\$3,723.00
7390	Classroom Security Holdback		

Note: Additional Dogging Indicator 188 – Available with all functions. Add \$573.00
How to order with Dogging Indicator: FM 7366 LNA x 188 x 26D x RH.
Not compatible with BL7300 series.

		Finish	
Function	Description	10BE/26D/ BSP/ WSP	03/04/09/10/ 10B/10BL/ 14/15/20D/ 26/32/32D
Electro-Mechanical Lock			
73270-12V/24V	Fail Safe		
73271-12V/24V	Fail Secure	\$4,023.00	\$4,046.00
73278	Motorized Key Override No Deadbolt	\$4,023.00	\$4,046.00
73279	Motorized No Deadbolt No Key Override		
Electrified Functions			
NAC 73280-12V/-24V*	Fail Safe w/Deadbolt w/Cylinder override	\$4,023.00	\$4,046.00
NAC 73281-12V/-24V*	Fail Secure w/Deadbolt w/Cylinder override		
NAC 73284-12V/-24V*	Fail Safe w/Deadbolt – No Cylinder override	\$3,890.00	\$3,913.00
NAC 73285-12V/-24V*	Fail Secure – No Cylinder override		

Note: This product is part of a complete assembly and must be used with a Ceco or Curries door. Concealed vertical rods, top & bottom latches, and the lockbody cassette will be factory installed. All other hardware components are shipped directly to the customer and must be installed by a factory trained installer. Invoices for the door will be separate from the hardware invoice. The hardware invoice will include the concealed vertical assembly and the trim components.

MP-16 MULTI-POINT LOCKS

SARGENT®

7300, FM7300, & BL7300 SERIES OPTIONS

ASSA ABLOY

USA & Canada Prices Effective May 1, 2021

Options	Description	Price
3	Stainless steel hub	\$69.00
10	SARGENT Signature Key System	\$63.00 / cyl.
11†	SARGENT XC Key System (not available w/10, KESO, SC, SE)	No addition
1160	SARGENT XC Large Format Interchangeable Plastic Disposable Construction Core	No addition
1163	SARGENT XC Large Format Interchangeable Core Cylinder - Includes masterkeying charges	\$83.00
1164	SARGENT XC Large Format Interchangeable Construction Core Cylinder	\$83.00
1170	Small Format interchangeable disposable construction core - to accept 7 Pin XC permanent core	No addition
11727P	Small Format interchangeable keyed construction core - to accept 7 Pin XC permanent core	\$75.00
11737P	Small Format interchangeable core - to accept 7 pin XC permanent core	\$75.00 / cyl.
21†	SARGENT Construction Key System (lost ball) Standard on all new systems established since 5/1/96	\$16.00 / cyl.
22†	SARGENT Construction Key System (split key) To be used on pre-established split key systems only	\$32.00 / cyl.
36	6 Lobe security head screws	\$64.00
37	Spanner head screws	\$46.00
60	SARGENT Large Format Interchangeable Plastic Disposable Construction Core	No addition
63	SARGENT Large Format Interchangeable core cylinder, includes master keying charges	\$83.00 / cyl
64	SARGENT Large Format Interchangeable Construction Core Cylinder	\$83.00
6573†	Small Format 6-Pin Uncombined Core (Refer to CK-12)	\$65.00 / cyl.
65737P†	Small Format 7-Pin Uncombined Core (Refer to CK-12)	\$65.00 / cyl.
70†	Small Format interchangeable disposable plastic construction core	No addition
72†	Small Format interchangeable 6-Pin construction core	\$75.00
73†	Small Format interchangeable core 6-pin Includes MK and GMK keying charges	\$75.00 / cyl
737P†	Small Format interchangeable core 7-pin (refer to CK-12 for available keyways) Includes MK and GMK keying charges	\$75.00 / cyl
75	Tactile Warning - Milled Inside Lever	\$78.00
76	Tactile Warning - Milled Outside Lever	\$78.00
77	Tactile Warning - Milled Outside and Inside Lever	\$156.00
81†	Cylinder to accept Keso (83) and Keso F1 (F183) removable core – no core provided	No addition
F182†	SARGENT Keso Security Cylinder – patented – new key systems	\$91.00 / cyl.
F183†	SARGENT Keso Security Removable Core Cylinder – patented – new key systems	\$130.00 / cyl.
82†	SARGENT Keso Security Cylinder (For existing systems only)	\$91.00 / cyl.
83†	SARGENT Keso Security Removable Core Cylinder (For existing systems only)	\$130.00 / cyl.
84†	SARGENT Keso Security Removable Construction Core Cylinder	See CK-18
85	Tactile Warning - Abrasive Coating on Inside Lever	\$49.00
86	Tactile Warning - Abrasive Coating on Outside Lever	\$49.00
87	Tactile Warning - Abrasive Coating on Outside & Inside Lever	\$98.00
BR	SARGENT Bump Resistant Cylinders (N/A w/10, 22, 30, 60, 63, 64, 70, 72, 73, 737P, KESO, SC, & SE options)	\$25.00/cyl.
DX	Deadbolt Monitoring	\$197.00
DG1	Patented Degree DG1 Key System	No addition
DG160	Hardware prepared for DG1-6300 Lg. Format IC cores, supplied with temporary plastic construction cores	No addition
DG163	Patented Degree DG1 Large Format Interchangeable Core Cylinder - Includes master keying charges	\$83.00
DG164	Hardware prepared for DG1-6300 Lg. Format IC cores, supplied with temporary keyed construction cores	\$83.00
DG2	Patented Degree DG2 Key System incorporating a locking sidebar	\$63.00/cyl.
DG260	Hardware prepared for DG2-6300 Lg. Format IC cores, supplied with temporary plastic construction cores	No addition
DG263	Patented Degree DG2 Large Format Interchangeable Core Cylinder - Includes master keying charges	\$146.00
DG264	Hardware prepared for DG2-6300 Lg. Format IC cores, supplied with temporary keyed construction cores	\$83.00
DG3	Patented Degree DG3 Key System incorporating a locking sidebar and UL437 listed	\$89.00/cyl.
DG360	Hardware prepared for DG3-6300 Lg. Format IC cores, supplied with temporary plastic construction cores	No addition
DG363	Patented Degree DG3 Large Format Interchangeable Core Cylinder - Includes master keying charges	\$172.00
DG364	Hardware prepared for DG3-6300 Lg. Format IC cores, supplied with temporary keyed construction cores	\$83.00
LB	Extra large thumbturn	\$18.00
LC	Less Cylinder	-\$96.00/cyl.
SC †	Schlage "C" Keyway cylinder, (Number 41 Cylinder Only, 0 bitted)	No addition
SE†	Schlage "E" Keyway cylinder, (Number 41 Cylinder Only, 0 bitted)	No addition
SG	MicroShield® – an antimicrobial powder coat finish	\$73.00
T1	Decorative thumbturn; backplate matches rose design chosen	No Addition
T2	Decorative square thumbturn; backplate matches rose design chosen	No Addition
T3	Decorative cylinder thumbturn; backplate matches rose design chosen	No Addition
TL	SARGuide™ – Illuminated escutcheon – refer to catalog for function limitations	\$232.00

NOTES: † Not avail. with 60, 63, 64 options

CPC Clear Powder Coat over 26D/32D \$67.00
All orders will continue to be handled as a "special" when CPC is ordered.

Experience a safer
and more open world

Copyright © 2002-2021 Sargent Manufacturing Company, an ASSA ABLOY Group company. All rights reserved.
Reproduction in whole or in part without the express written permission of Sargent Manufacturing Company is prohibited.
Contact us at: 800-727-5477 or visit www.sargentlock.com. In Canada contact us at: 800-461-3007 or visit www.assaabloydss.ca

ASSA ABLOY

7300, FM7300, & BL7300 SERIES

USA & Canada Prices Effective May 1, 2021



LE1A
(Handed)

7300, FM7300, & BL7300 SERIES

Standard Escutcheon Designs: LE1, LE2, LE3, LE4, LW1
Standard Lever Designs: A, B, E, F, J, L, P, W

Studio Escutcheon Designs: CE, TE, LE1

Studio Collection Levers Except for Gramercy, Wooster Square, & Grant Park

For Gramercy, Wooster Square, & Grant Park Levers – Add \$138.00 to below prices

Please specify hand when ordering.

Finishes listed below are for ET trim on both sides.

Refer to catalog for available trims, trim finishes and how to order.

Series	Description	Price
FM	FM7300 Fema	\$400.00
BL	BL7300 Blast	\$800.00

*FM7300 and BL7300 are only available with 7318, 7324, 7325, 7301, 7366, 7368, 7326, 7339, 7340, 7341, 7349, 73280/81/84/85 functions

		Finish	
		10BE/26D	03/04/09/10/10B/10BL
Function	Description	BSP/WSP	14/15/20D/26/32/32D
Single Cylinder without Deadbolt			
7305	Office/Entry		
7337	Classroom		
7356	Office & Inner Entry Lock	\$3,738.00	\$3,761.00
7389	Holdback		
Single Cylinder with Deadbolt			
7318*	Classroom		
7324*	Storeroom	\$3,738.00	\$3,761.00
7325*	Exit/Dormitory		
7327	Closet or Storeroom		
Non-Keyed			
7301*	Inside Passage		
7314	Passage		
7366*	Privacy Bath	\$3,738.00	\$3,761.00
7368*	Privacy Bedroom		
7319	Passage or Closet		
7365	Privacy Bath/Bedroom		
Double Cylinder with Deadbolt			
7326*	Store Door		
7339*	Classroom Security Intruder Deadbolt		
7340*	Classroom Security Intruder Auxiliary Deadbolt	\$3,738.00	\$3,761.00
7341*	Classroom Security Intruder Deadlatch		
7349*	Security Deadbolt		
Double Cylinder without Deadbolt			
7338	Classroom Security Intruder Latchbolt	\$3,738.00	\$3,761.00
7390	Classroom Security Holdback		

Note: Additional Dogging Indicator 188 – Available with all functions. Add \$573.00
How to order with Dogging Indicator: FM 7366 LNA x 188 x 26D x RH.
Not compatible with BL7300 series.

		Finish	
		10BE/26D/	03/04/09/10/10B/10BL/
Function	Description	BSP/WSP	14/15/20D/26/32/32D
Electro-Mechanical Lock			
73270-12V/24V	Fail Safe		
73271-12V/24V	Fail Secure	\$4,061.00	\$4,084.00
73278	Motorized Key Override No Deadbolt		
73279	Motorized No Deadbolt No Key Override	\$4,061.00	\$4,084.00
Electrified Functions			
NAC	Fail Safe w/Deadbolt		
73280-12V/-24V*	w/Cylinder override	\$4,023.00	\$4,046.00
NAC	Fail Secure w/Deadbolt		
73281-12V/-24V*	w/Cylinder override		
NAC	Fail Safe w/Deadbolt		
73284-12V/-24V*	– No Cylinder override	\$3,890.00	\$3,913.00
NAC	Fail Secure		
73285-12V/-24V*	– No Cylinder override		

Note: This product is part of a complete assembly and must be used with a Ceco or Curries door. Concealed vertical rods, top & bottom latches, and the lockbody cassette will be factory installed. All other hardware components are shipped directly to the customer and must be installed by a factory trained installer. Invoices for the door will be separate from the hardware invoice. The hardware invoice will include the concealed vertical assembly and the trim components.

Experience a safer
and more open world

MP-18 MULTI-POINT LOCKS

SARGENT®

7300, FM7300, & BL7300 SERIES OPTIONS

ASSA ABLOY

USA & Canada Prices Effective May 1, 2021

Options	Description	Price
3	Stainless steel hub	\$69.00
10	SARGENT Signature Key System	\$63.00 / cyl.
11†	SARGENT XC Key System (not available w/10, KESO, SC, SE)	No addition
21†	SARGENT Construction Key System (lost ball) Standard on all new systems established since 5/1/96	\$16.00 / cyl.
22†	SARGENT Construction Key System (split key) To be used on pre-established split key systems only	\$32.00 / cyl.
31	Thick Doors - Extended Lip Required - Specify Length C to E - Cylinders -IMPORTANT- See catalog 7800/8200 prefix page for cylinder limitations - Below charges DO NOT include additional charges for special cylinder requirements Doors up to 2-1/2" thick - lock centered Doors 2-5/8" to 6" thick OR doors 1-3/4" thick w/max 1" paneling one side. For example: Specify 1-3/4" door with panel (Side) on inside or outside	No addition
31	Non Keyed function	\$50.00
31	Keyed function	\$100.00
36	6 Lobe security head screws	\$64.00
37	Spanner head screws	\$46.00
49	Visual Status Indicator – Available with 30, 36, 37 function – Rose Trims CR, E, L, LN, O, TR – Available with 26, 29, 38, 39 40, 41 functions – Rose Trim 8200 LN	\$140.00
49	Occupancy Indicator with emergency Release Available with 65, 66, 68 functions; Rose Trims 7800 CR, E, L, LN, O, TR	\$140.00
50	Secured Indicator Rose – for doors 1-5/8" to 2-1/4" thick Available with 24, 25, 26, 28, 29, 30, 36, 37 38, 39, 40, 41, 43, 45, 50, 51, 52, 67 functions	\$140.00
68	8200 Line furnished with lever handle outside x knob inside (Excludes SLD Detention Knob)	Defaults to 8200 Lever Lock Price
69	8200 Line furnished with lever handle inside x knob outside (Excludes SLD Detention Knob)	Defaults to 8200 Lever Lock Price
74	Lock case wrapped in lead ñ handling required (roses not available)	\$294.00
75	Tactile Warning - Milled Inside Lever	\$78.00
76	Tactile Warning - Milled Outside Lever	\$78.00
77	Tactile Warning - Milled Outside and Inside Lever	\$156.00
81†	Cylinder to accept Keso (83) and Keso F1 (F183) removable core – no core provided	No addition
F182†	SARGENT Keso Security Cylinder – patented – new key systems	\$91.00 / cyl.
F183†	SARGENT Keso Security Removable Core Cylinder – patented – new key systems	\$130.00 / cyl.
82†	SARGENT Keso Security Cylinder (For existing systems only)	\$91.00 / cyl.
83†	SARGENT Keso Security Removable Core Cylinder (For existing systems only)	\$130.00 / cyl.
84†	SARGENT Keso Security Removable Construction Core Cylinder	See CK-18
85	Tactile Warning - Abrasive Coating on Inside Lever	\$49.00
86	Tactile Warning - Abrasive Coating on Outside Lever	\$49.00
87	Tactile Warning - Abrasive Coating on Outside & Inside Lever	\$98.00
BR	SARGENT Bump Resistant Cylinders (N/A w/10, 22, 30, 60, 63, 64, 70, 72, 73, 737P, KESO, SC, & SE options)	\$25.00 /cyl.
DX	Deadbolt Monitoring	\$197.00
DG2	Patented Degree DG2 Key System incorporating a locking sidebar	\$63.00/cyl.
DG3	Patented Degree DG3 Key System incorporating a locking sidebar and UL437 listed	\$89.00/cyl.
LB	Extra large thumbturn	\$18.00
LC	Less Cylinder	-\$96.00/cyl.
SC▲†	Schlage "C" Keyway cylinder, (Number 41 Cylinder Only, 0 bitted)	No addition
SE▲†	Schlage "E" Keyway cylinder, (Number 41 Cylinder Only, 0 bitted)	No addition
SG	MicroShield® – an antimicrobial powder coat finish	\$73.00
T1	Decorative thumbturn; backplate matches rose design chosen	No Addition
T2	Decorative square thumbturn; backplate matches rose design chosen	No Addition
T3	Decorative cylinder thumbturn; backplate matches rose design chosen	No Addition
TL	SARGuide™ – Illuminated escutcheon – refer to catalog for function limitations	\$232.00
NOTES: † Not avail. with 60, 63, 64 options		
CPC	Clear Powder Coat over 26D/32D All orders will continue to be handled as a "special" when CPC is ordered.	\$67.00

Experience a safer
and more open world

Copyright © 2002-2021 Sargent Manufacturing Company, an ASSA ABLOY Group company. All rights reserved.
Reproduction in whole or in part without the express written permission of Sargent Manufacturing Company is prohibited.
Contact us at: 800-727-5477 or visit www.sargentlock.com. In Canada contact us at: 800-461-3007 or visit www.assaabloydss.ca



LS

7300, FM7300, & BL7300 SERIES

Escutcheon Design: LS

Standard Lever Designs: A, B, E, F, J, L, P, W

Please specify hand when ordering.

Finishes listed below are for ET trim on both sides.

Refer to catalog for available trims, trim finishes and how to order.

Series	Description	Price
FM	FM7300 Fema	\$400.00
BL	BL7300 Blast	\$800.00

*FM7300 and BL7300 are only available with 7318, 7324, 7325, 7301, 7366, 7368, 7326, 7339, 7340, 7341, 7349, 73280/81/84/85 functions

		Finish	
Single Cylinder without Deadbolt		10BE/26D BSP/WSP	03/04/09/10/10B/10BL 14/15/20D/26/32/32D
Function	Description		
7305	Office/Entry		
7337	Classroom		
7356	Office & Inner Entry Lock	\$4,175.00	\$4,198.00
7389	Holdback		
Single Cylinder with Deadbolt			
Function	Description		
7318*	Classroom		
7324*	Storeroom	\$4,175.00	\$4,198.00
7325*	Exit/Dormitory		
7327	Closet or Storeroom		
Non-Keyed			
Function	Description		
7301*	Inside Passage		
7314	Passage		
7366*	Privacy Bath	\$4,175.00	\$4,198.00
7368*	Privacy Bedroom		
7319	Passage or Closet		
7365	Privacy Bath/Bedroom		
Double Cylinder with Deadbolt			
Function	Description		
7326*	Store Door		
7339*	Classroom Security Intruder Deadbolt		
7340*	Classroom Security Intruder Auxiliary Deadbolt	\$4,175.00	\$4,198.00
7341*	Classroom Security Intruder Deadlatch		
7349*	Security Deadbolt		
Double Cylinder without Deadbolt			
Function	Description		
7338	Classroom Security Intruder Latchbolt	\$4,175.00	\$4,198.00
7390	Classroom Security Holdback		

Note: Additional Dogging Indicator 188 – Available with all functions.
How to order with Dogging Indicator: FM 7366 LNA x 188 x 26D x RH. Add \$573.00
Not compatible with BL7300 series.

		Finish	
Electro-Mechanical Lock		10BE/ 26D/ BSP/ WSP	03/04/09/10/ 10B/10BL/ 14/15/20D/ 26/32/32D
Function	Description		
73270-12V/24V	Fail Safe		
73271-12V/24V	Fail Secure	\$4,497.00	\$4,521.00
73278	Motorized Key Override No Deadbolt	\$4,497.00	\$4,521.00
73279	Motorized No Deadbolt No Key Override		
Electrified Functions			
NAC	Fail Safe w/Deadbolt w/Cylinder override	\$4,023.00	\$4,046.00
NAC	Fail Secure w/Deadbolt w/Cylinder override		
NAC	Fail Safe w/Deadbolt – No Cylinder override	\$3,890.00	\$3,913.00
NAC	Fail Secure – No Cylinder override		

Note: This product is part of a complete assembly and must be used with a Ceco or Curries door. Concealed vertical rods, top & bottom latches, and the lockbody cassette will be factory installed. All other hardware components are shipped directly to the customer and must be installed by a factory trained installer. Invoices for the door will be separate from the hardware invoice. The hardware invoice will include the concealed vertical assembly and the trim components.

MP-20 MULTI-POINT LOCKS

SARGENT®

7300, FM7300, & BL7300 SERIES OPTIONS

ASSA ABLOY

USA & Canada Prices Effective May 1, 2021

Options	Description	Price
3	Stainless steel hub	\$69.00
10	SARGENT Signature Key System	\$63.00 / cyl.
11†	SARGENT XC Key System (not available w/10, KESO, SC, SE)	No addition
1160	SARGENT XC Large Format Interchangeable Plastic Disposable Construction Core	No addition
1163	SARGENT XC Large Format Interchangeable Core Cylinder - Includes masterkeying charges	\$83.00
1164	SARGENT XC Large Format Interchangeable Construction Core Cylinder	\$83.00
1170	Small Format interchangeable disposable construction core - to accept 7 Pin XC permanent core	No addition
11727P	Small Format interchangeable keyed construction core - to accept 7 Pin XC permanent core	\$75.00
11737P	Small Format interchangeable core - to accept 7 pin XC permanent core	\$75.00 / cyl.
21†	SARGENT Construction Key System (lost ball) Standard on all new systems established since 5/1/96	\$16.00 / cyl.
22†	SARGENT Construction Key System (split key) To be used on pre-established split key systems only	\$32.00 / cyl.
36	6 Lobe security head screws	\$64.00
37	Spanner head screws	\$46.00
60	SARGENT Large Format Interchangeable Plastic Disposable Construction Core	No addition
63	SARGENT Large Format Interchangeable core cylinder, includes master keying charges	\$83.00 / cyl
64	SARGENT Large Format Interchangeable Construction Core Cylinder	\$83.00
6573†	Small Format 6-Pin Uncombined Core (Refer to CK-12)	\$65.00 / cyl.
65737P†	Small Format 7-Pin Uncombined Core (Refer to CK-12)	\$65.00 / cyl.
70†	Small Format interchangeable disposable plastic construction core	No addition
72†	Small Format interchangeable 6-Pin construction core	\$75.00
73†	Small Format interchangeable core 6-pin Includes MK and GMK keying charges	\$75.00 / cyl
737P†	Small Format interchangeable core 7-pin (refer to CK-12 for available keyways) Includes MK and GMK keying charges	\$75.00 / cyl
75	Tactile Warning - Milled Inside Lever	\$78.00
76	Tactile Warning - Milled Outside Lever	\$78.00
77	Tactile Warning - Milled Outside and Inside Lever	\$156.00
81▲†	Cylinder to accept Keso (83) and Keso F1 (F183) removable core – no core provided	No addition
F182†	SARGENT Keso Security Cylinder – patented – new key systems	\$91.00 / cyl.
F183▲†	SARGENT Keso Security Removable Core Cylinder – patented – new key systems	\$130.00 / cyl.
82†	SARGENT Keso Security Cylinder (For existing systems only)	\$91.00 / cyl.
83▲†	SARGENT Keso Security Removable Core Cylinder (For existing systems only)	\$130.00 / cyl.
84▲†	SARGENT Keso Security Removable Construction Core Cylinder	See CK-18
85	Tactile Warning - Abrasive Coating on Inside Lever	\$49.00
86	Tactile Warning - Abrasive Coating on Outside Lever	\$49.00
87	Tactile Warning - Abrasive Coating on Outside & Inside Lever	\$98.00
BR	SARGENT Bump Resistant Cylinders (N/A w/10, 22, 30, 60, 63, 64, 70, 72, 73, 737P, KESO, SC, & SE options)	\$25.00/cyl.
DX	Deadbolt Monitoring	\$197.00
DG1	Patented Degree DG1 Key System	No addition
DG160	Hardware prepared for DG1-6300 Lg. Format IC cores, supplied with temporary plastic construction cores	No addition
DG163	Patented Degree DG1 Large Format Interchangeable Core Cylinder - Includes master keying charges	\$83.00
DG164	Hardware prepared for DG1-6300 Lg. Format IC cores, supplied with temporary keyed construction cores	\$83.00
DG2	Patented Degree DG2 Key System incorporating a locking sidebar	\$63.00/cyl.
DG260	Hardware prepared for DG2-6300 Lg. Format IC cores, supplied with temporary plastic construction cores	No addition
DG263	Patented Degree DG2 Large Format Interchangeable Core Cylinder - Includes master keying charges	\$146.00
DG264	Hardware prepared for DG2-6300 Lg. Format IC cores, supplied with temporary keyed construction cores	\$83.00
DG3	Patented Degree DG3 Key System incorporating a locking sidebar and UL437 listed	\$89.00/cyl.
DG360	Hardware prepared for DG3-6300 Lg. Format IC cores, supplied with temporary plastic construction cores	No addition
DG363	Patented Degree DG3 Large Format Interchangeable Core Cylinder - Includes master keying charges	\$172.00
DG364	Hardware prepared for DG3-6300 Lg. Format IC cores, supplied with temporary keyed construction cores	\$83.00
LB	Extra large thumbturn	\$18.00
LC	Less Cylinder	-\$96.00/cyl.
SC▲†	Schlage "C" Keyway cylinder, (Number 41 Cylinder Only, 0 bitted)	No addition
SE▲†	Schlage "E" Keyway cylinder, (Number 41 Cylinder Only, 0 bitted)	No addition
SG	MicroShield® – an antimicrobial powder coat finish	\$73.00
T1	Decorative thumbturn; backplate matches rose design chosen	No Addition
T2	Decorative square thumbturn; backplate matches rose design chosen	No Addition
T3	Decorative cylinder thumbturn; backplate matches rose design chosen	No Addition
TL	SARGuide™ – Illuminated escutcheon – refer to catalog for function limitations	\$232.00

NOTES: † Not avail. with 60, 63, 64 options

CPC Clear Powder Coat over 26D/32D \$67.00
All orders will continue to be handled as a "special" when CPC is ordered.

Experience a safer
and more open world

Copyright © 2002-2021 Sargent Manufacturing Company, an ASSA ABLOY Group company. All rights reserved.
Reproduction in whole or in part without the express written permission of Sargent Manufacturing Company is prohibited.
Contact us at: 800-727-5477 or visit www.sargentlock.com. In Canada contact us at: 800-461-3007 or visit www.assaabloydss.ca



7300, FM7300, & BL7300 SERIES
Escutcheon Design: WT
Standard Lever Designs: A, B, E, F, J, L, P, W

Please specify hand when ordering.

Finishes listed below are for ET trim on both sides.
 Refer to catalog for available trims, trim finishes and how to order.

Series	Description	Price
FM	FM7300 Fema	\$400.00
BL	BL7300 Blast	\$800.00

*FM7300 and BL7300 are only available with 7318, 7324, 7325, 7301, 7366, 7368, 7326, 7339, 7340, 7341, 7349, 73280/81/84/85 functions

		Finish	
Single Cylinder without Deadbolt		10BE/26D BSP/WSP	03/04/09/10/10B/10BL 14/15/20D/26/32/32D
Function	Description		
7305	Office/Entry		
7337	Classroom		
7356	Office & Inner Entry Lock	\$3,652.00	\$3,676.00
7389	Holdback		
Single Cylinder with Deadbolt			
Function	Description		
7318*	Classroom		
7324*	Storeroom	\$3,652.00	\$3,676.00
7325*	Exit/Dormitory		
7327	Closet or Storeroom		
Non-Keyed			
Function	Description		
7301*	Inside Passage		
7314	Passage		
7366*	Privacy Bath	\$3,652.00	\$3,676.00
7368*	Privacy Bedroom		
7319	Passage or Closet		
7365	Privacy Bath/Bedroom		
Double Cylinder with Deadbolt			
Function	Description		
7326*	Store Door		
7339*	Classroom Security Intruder Deadbolt		
7340*	Classroom Security Intruder Auxiliary Deadbolt	\$3,652.00	\$3,676.00
7341*	Classroom Security Intruder Deadlatch		
7349*	Security Deadbolt		
Double Cylinder without Deadbolt			
Function	Description		
7338	Classroom Security Intruder Latchbolt	\$3,652.00	\$3,676.00
7390	Classroom Security Holdback		

		Finish	
Electro-Mechanical Lock		10BE/ 26D/ BSP/ WSP	03/04/09/10/ 10B/10BL/ 14/15/20D/ 26/32/32D
Function	Description		
73270-12V/24V	Fail Safe		
73271-12V/24V	Fail Secure	\$3,975.00	\$3,998.00
73278	Motorized Key Override No Deadbolt	\$3,975.00	\$3,998.00
73279	Motorized No Deadbolt No Key Override		
Electrified Functions			
NAC	Fail Safe w/Deadbolt w/Cylinder override	\$4,023.00	\$4,046.00
NAC	Fail Secure w/Deadbolt w/Cylinder override		
NAC	Fail Safe w/Deadbolt - No Cylinder override	\$3,890.00	\$3,913.00
NAC	Fail Secure - No Cylinder override		

Note: Additional Dogging Indicator 188 – Available with all functions.
How to order with Dogging Indicator: FM 7366 LNA x 188 x 26D x RH. Add \$573.00
Not compatible with BL7300 series.

Note: This product is part of a complete assembly and must be used with a Ceco or Curries door. Concealed vertical rods, top & bottom latches, and the lockbody cassette will be factory installed. All other hardware components are shipped directly to the customer and must be installed by a factory trained installer. Invoices for the door will be separate from the hardware invoice. The hardware invoice will include the concealed vertical assembly and the trim components.

MP-22 MULTI-POINT LOCKS

SARGENT®

7300, FM7300, & BL7300 SERIES OPTIONS

ASSA ABLOY

USA & Canada Prices Effective May 1, 2021

Options	Description	Price
3	Stainless steel hub	\$69.00
10	SARGENT Signature Key System	\$63.00 / cyl.
11†	SARGENT XC Key System (not available w/10, KESO, SC, SE)	No addition
1160	SARGENT XC Large Format Interchangeable Plastic Disposable Construction Core	No addition
1163	SARGENT XC Large Format Interchangeable Core Cylinder - Includes masterkeying charges	\$83.00
1164	SARGENT XC Large Format Interchangeable Construction Core Cylinder	\$83.00
1170	Small Format interchangeable disposable construction core - to accept 7 Pin XC permanent core	No addition
11727P	Small Format interchangeable keyed construction core - to accept 7 Pin XC permanent core	\$75.00
11737P	Small Format interchangeable core - to accept 7 pin XC permanent core	\$75.00 / cyl.
21†	SARGENT Construction Key System (lost ball) Standard on all new systems established since 5/1/96	\$16.00 / cyl.
22†	SARGENT Construction Key System (split key) To be used on pre-established split key systems only	\$32.00 / cyl.
36	6 Lobe security head screws	\$64.00
37	Spanner head screws	\$46.00
60	SARGENT Large Format Interchangeable Plastic Disposable Construction Core	No addition
63	SARGENT Large Format Interchangeable core cylinder, includes master keying charges	\$83.00 / cyl
64	SARGENT Large Format Interchangeable Construction Core Cylinder	\$83.00
6573†	Small Format 6-Pin Uncombined Core (Refer to CK-12)	\$65.00 / cyl.
65737P†	Small Format 7-Pin Uncombined Core (Refer to CK-12)	\$65.00 / cyl.
70†	Small Format interchangeable disposable plastic construction core	No addition
72†	Small Format interchangeable 6-Pin construction core	\$75.00
73†	Small Format interchangeable core 6-pin Includes MK and GMK keying charges	\$75.00 / cyl
737P†	Small Format interchangeable core 7-pin (refer to CK-12 for available keyways) Includes MK and GMK keying charges	\$75.00 / cyl
75	Tactile Warning - Milled Inside Lever	\$78.00
76	Tactile Warning - Milled Outside Lever	\$78.00
77	Tactile Warning - Milled Outside and Inside Lever	\$156.00
81†	Cylinder to accept Keso (83) and Keso F1 (F183) removable core – no core provided	No addition
F182†	SARGENT Keso Security Cylinder – patented – new key systems	\$91.00 / cyl.
F183†	SARGENT Keso Security Removable Core Cylinder – patented – new key systems	\$130.00 / cyl.
82†	SARGENT Keso Security Cylinder (For existing systems only)	\$91.00 / cyl.
83▲†	SARGENT Keso Security Removable Core Cylinder (For existing systems only)	\$130.00 / cyl.
84▲†	SARGENT Keso Security Removable Construction Core Cylinder	See CK-18
85	Tactile Warning - Abrasive Coating on Inside Lever	\$49.00
86	Tactile Warning - Abrasive Coating on Outside Lever	\$49.00
87	Tactile Warning - Abrasive Coating on Outside & Inside Lever	\$98.00
BR	SARGENT Bump Resistant Cylinders (N/A w/10, 22, 30, 60, 63, 64, 70, 72, 73, 737P, KESO, SC, & SE options)	\$25.00/cyl.
DX	Deadbolt Monitoring	\$197.00
DG1	Patented Degree DG1 Key System	No addition
DG160	Hardware prepared for DG1-6300 Lg. Format IC cores, supplied with temporary plastic construction cores	No addition
DG163	Patented Degree DG1 Large Format Interchangeable Core Cylinder - Includes master keying charges	\$83.00
DG164	Hardware prepared for DG1-6300 Lg. Format IC cores, supplied with temporary keyed construction cores	\$83.00
DG2	Patented Degree DG2 Key System incorporating a locking sidebar	\$63.00/cyl.
DG260	Hardware prepared for DG2-6300 Lg. Format IC cores, supplied with temporary plastic construction cores	No addition
DG263	Patented Degree DG2 Large Format Interchangeable Core Cylinder - Includes master keying charges	\$146.00
DG264	Hardware prepared for DG2-6300 Lg. Format IC cores, supplied with temporary keyed construction cores	\$83.00
DG3	Patented Degree DG3 Key System incorporating a locking sidebar and UL437 listed	\$89.00/cyl.
DG360	Hardware prepared for DG3-6300 Lg. Format IC cores, supplied with temporary plastic construction cores	No addition
DG363	Patented Degree DG3 Large Format Interchangeable Core Cylinder - Includes master keying charges	\$172.00
DG364	Hardware prepared for DG3-6300 Lg. Format IC cores, supplied with temporary keyed construction cores	\$83.00
LB	Extra large thumbturn	\$18.00
LC	Less Cylinder	-\$96.00/cyl.
SC▲†	Schlage "C" Keyway cylinder, (Number 41 Cylinder Only, 0 bitted)	No addition
SE▲†	Schlage "E" Keyway cylinder, (Number 41 Cylinder Only, 0 bitted)	No addition
SG	MicroShield® – an antimicrobial powder coat finish	\$73.00
T1	Decorative thumbturn; backplate matches rose design chosen	No Addition
T2	Decorative square thumbturn; backplate matches rose design chosen	No Addition
T3	Decorative cylinder thumbturn; backplate matches rose design chosen	No Addition
TL	SARGuide™ – Illuminated escutcheon – refer to catalog for function limitations	\$232.00

NOTES: † Not avail. with 60, 63, 64 options

CPC Clear Powder Coat over 26D/32D \$67.00
All orders will continue to be handled as a "special" when CPC is ordered.

Experience a safer
and more open world

Copyright © 2002-2021 Sargent Manufacturing Company, an ASSA ABLOY Group company. All rights reserved.
Reproduction in whole or in part without the express written permission of Sargent Manufacturing Company is prohibited.
Contact us at: 800-727-5477 or visit www.sargentlock.com. In Canada contact us at: 800-461-3007 or visit www.assaabloydss.ca

USA & Canada Prices Effective May 1, 2021



FEL

7300, FM7300, & BL7300 SERIES
Escutcheon Design: FE
Standard Lever Designs: A, B, E, F, J, L, P, W

Please specify hand when ordering.

Finishes listed below are for ET trim on both sides.
 Refer to catalog for available trims, trim finishes and how to order.

Series	Description	Price
FM	FM7300 Fema	\$400.00
BL	BL7300 Blast	\$800.00

*FM7300 and BL7300 are only available with 7318, 7324, 7325, 7301, 7366, 7368, 7326, 7339, 7340, 7341, 7349, 73280/81/84/85 functions

		Finish	
Function	Description	10BE/26D/ BSP/WSP	03/04/09/10/10B/10BL/ 14/15/20D/26/32/32D
Single Cylinder without Deadbolt			
7305	Office/Entry		
7337	Classroom		
7356	Office & Inner Entry Lock	\$3,652.00	\$3,676.00
7389	Holdback		
Single Cylinder with Deadbolt			
7318*	Classroom		
7324*	Storeroom	\$3,652.00	\$3,676.00
7325*	Exit/Dormitory		
7327	Closet or Storeroom		
Non-Keyed			
7301*	Inside Passage		
7314	Passage		
7366*	Privacy Bath	\$3,652.00	\$3,676.00
7368*	Privacy Bedroom		
7319	Passage or Closet		
7365	Privacy Bath/Bedroom		
Double Cylinder with Deadbolt			
7326*	Store Door		
7339*	Classroom Security Intruder Deadbolt		
7340*	Classroom Security Intruder Auxiliary Deadbolt	\$3,652.00	\$3,676.00
7341*	Classroom Security Intruder Deadlatch		
7349*	Security Deadbolt		
Double Cylinder without Deadbolt			
7338	Classroom Security Intruder Latchbolt	\$3,652.00	\$3,676.00
7390	Classroom Security Holdback		

		Finish	
Function	Description	10BE/ 26D/ BSP/ WSP	03/04/09/10/ 10B/10BL/ 14/15/20D/ 26/32/32D
Electro-Mechanical Lock			
73270-12V/24V	Fail Safe		
73271-12V/24V	Fail Secure	\$3,975.00	\$3,998.00
73278	Motorized Key Override No Deadbolt	\$3,975.00	\$3,998.00
73279	Motorized No Deadbolt No Key Override		
Electrified Functions			
NAC	Fail Safe w/Deadbolt w/Cylinder override	\$4,023.00	\$4,046.00
NAC	Fail Secure w/Deadbolt w/Cylinder override		
NAC	Fail Safe w/Deadbolt - No Cylinder override	\$3,890.00	\$3,913.00
NAC	Fail Secure - No Cylinder override		

Note: Additional Dogging Indicator 188 – Available with all functions. Add \$573.00
How to order with Dogging Indicator: FM 7366 LNA x 188 x 26D x RH.
Not compatible with BL7300 series.

Note: This product is part of a complete assembly and must be used with a Ceco or Curries door. Concealed vertical rods, top & bottom latches, and the lockbody cassette will be factory installed. All other hardware components are shipped directly to the customer and must be installed by a factory trained installer. Invoices for the door will be separate from the hardware invoice. The hardware invoice will include the concealed vertical assembly and the trim components.

DOOR CLOSERS

How to Order/ANSI Finish & Function Comparison.....	DC-1
Additional Features	DC-2
281/351/1431 Series	DC-3
351 Pocket Closer/268, 269, 281 Security Package Closer/ 422 Cam Action Door Closer/268, 269, 278 Concealed Closers	DC-4
Finish Options	DC-5
Arms, Accessories.....	DC-6
Bodies & Covers	DC-7
1331 & 1131 Series.....	DC-8

Parts

Parts 01-0134 thru 63-3837	DC-9
Parts 63-3839 thru 64-2409	DC-10

HOLDERS & STOPS

590, 690, 1530, 1540 Series and Accessories	HS-1
1560 Electromagnetic Door Holder.....	HS-2

GENERAL INFORMATION

USA & Canada Prices Effective May 1, 2021

How To Order

Step	Description	Example
Quantity	Each	20 Ea.
Series	351, 268, 269, 278, 281, 422, 1431, 1131	20 Ea.- 281
Arm	Consult proper section for arms available	20 Ea.- 281-P10
Finish	Consult proper section for finishes available	20 Ea.- 281-P10-EB
Hand	Consult proper section to determine if handing is required	20 Ea.- 281-P10-EB
Option	Consult proper section for options available	20 Ea.- SR -281-P10-EB
Miscellaneous	Overhead holder template number	Template number _____

ANSI Finish and Function Comparison

Function		Finish		
SARGENT	ANSI	SARGENT	ANSI	Description
Arm Type		EN	689	Aluminum Powder Coat
O	CO2011	EB	695	Bronze Powder Coat to match 10B
P9	CO2021	ED	693	Black Powder Coat to match 20D
H	CO2051	EP	691	Bronze Powder Coat to match 10
PH9	CO2061	EAB	696	Brass Powder Coat to be used with Brass finishes
F	CO2091	3	605	Bright Brass, Clear Coated Polished Brass
PF9	CO2101	4	606	Satin Brass, Clear Coated Dull Brass
O	CO2041	9	637	Bright Bronze, Clear Coated
H	CO2081	10	612	Satin Bronze, Clear Coated Dull Bronze
F	CO2121	10B	613	Dark Oxidized Dull Bronze, Oil Rubbed
268-O	CO5031	10BE	613E	Dark Oxidized Satin Bronze - Equivalent
269-O	CO5041	15	619	Dull Nickel with Clear Coat
278-H	CO5091	20D	–	Statuary Dark Bronze with Clear Coat
278-O	CO5011	26	625	Bright Chromium Plated Polished Chrome
278-F	CO5101	26D	626	Satin Chromium Plated Dull Chrome
		10BL	–	Oxidized Dull Bronze with Clear Coat
		BSP	–	Black Suede Powder Coat
		WSP	–	White Suede Powder Coat

NOTES:

- 351, 268, 269, 278, 281, 422, 1431, 1331 and 1131 Series Closers are ANSI/BHMA A156.4 – 2000 Grade 1 certified
- 351, 268, 269, 278, 281, 422, 1431 and 1331 Series Closers are UL10C listed for positive pressure fire test
- 351, 281 and 1431 Series closers are certified for above ANSI functions including PT4 options A, B, D, E, F, G, H
- 1131, 1331 Series closers are certified for above ANSI functions including PT4 options A, B, C, D, H

DC-2 DOOR CLOSERS

SARGENT®

ASSA ABLOY

ADDITIONAL FEATURES

USA & Canada Prices Effective May 1, 2021

Additional Features with Door Closers		
Options	Description	Price
ABC	Advanced Backcheck: 281 Series only	\$32.00
DA	Delayed Action: 351, 281, 268, 269, 1431 Series	\$41.00
EC	Environmentally friendly ABS plastic cover (281 Series only)	\$5.00
LDP	Retrofit Plate	\$112.00
MC*	Closer w/Metal cover - Handed, indicate RH or LH To order covers separately, refer to DC-7	\$19.00
SRI	Corrosion Protection - Additional Special Rust Inhibitor: 268, 269, 278, 281, 1131, 1331 Series - Not available w/plated finishes - Arm & Body	\$46.00
36*	6-Lobe screws (Security Torx-Machine screws only)	\$26.00
TB	Mortise Nuts for use with machine screws, supplied with closer (not available with 268 & 269 series)	\$6.00
WD	Wood screws for wood door application	No Addition
Factory sizing upon request - specify size		No Addition

*Options available with 281, 351, 422, & 1431 Series

Standard Features:		
Backcheck: 351, 281, 422, 1431 Series - Standard		No Addition
Pressure Relief Valves: 268, 281, 422, 278, 1431 Series - Standard		No Addition
Extreme Temperature Fluid: 268, 278, 281, 422, 351, 1431 Series - Standard		No Addition

Installation Aids/Miscellaneous Parts		
Part #	Description	Price
4TB	Mortise Nuts ordered separate – used w/Machine Screws (provided w/every closer) (4 per set)	\$16.00 /Set
82-3855	Torx Bit Kit (Sizes T8, T9, T10, T15, T20, T25, T27)	\$172.00 /each
82-3856	Spanner Bit Kit (Sizes 4, 6, 8, 10, 12, 1/4")	\$133.88 /each
63-0694	Hex Wrench, for indexing and adjusting PH10 arms	\$6.30 /each

Notes: Lead Line Covers available with 351, 281, 422 and 1431 closers Add \$196.00

How to Order: 351 x EN x Lead Line Cover
Orders will be handled as "special" – Discounts do not apply.



Surface Closer		10BE/EB/ED/EN/EP/EAB/BSP/WSP Finishes		
Application		1431	281	351
Wrought Standard Arm	RO	\$499.00	NA	NA
Wrought Parallel Arm	RP9	\$499.00	NA	NA
Wrought Universal Arm	RUO	\$506.00	NA	NA
Standard Arm	O, OLC, O8, OZ, OZA	\$513.00	\$622.00	\$598.00
Standard Arm - Pocket	OP	NA	NA	\$598.00
Parallel Arm	P3**, P3A, P4**, P4A, P9	\$513.00	\$622.00	\$598.00
Standard Heavy Duty Arm (fits 281 only)	O10	NA	\$664.00	NA
Parallel Heavy Duty Arm	P10	\$555.00	\$664.00	\$640.00
Parallel Heavy Duty Drop Arm	PD10 **	NA	\$664.00	\$640.00
Universal Arm	UO	\$518.00	\$627.00	\$603.00
Holder Arm	H, H8*, HZ, HZA *(H8 Handed)	\$578.00	\$687.00	\$663.00
Parallel Holder Arm	PH4, PH9	\$578.00	\$687.00	\$663.00
Universal Holder Arm	UH	\$578.00	\$687.00	\$663.00
Parallel Holder Heavy Duty Arm	PH10* *(Handed)	\$596.00	\$705.00	\$681.00
Standard Holder Heavy Duty Arm	H10	NA	\$705.00	NA
Parallel Stop Heavy Duty Arm	PS	\$590.00	\$699.00	\$675.00
Compression Stop Heavy Duty Arm	CPS	\$720.00	\$829.00	\$805.00
Parallel Stop/Holder Heavy Duty Arm	PSH	\$658.00	\$767.00	\$743.00
Compression Holder Heavy Duty Arm	CPSH	\$786.00	\$895.00	\$871.00
Track Arm	OT, POT	\$577.00	\$686.00	\$662.00
Track Arm - Pocket Arm	OTP	NA	NA	\$662.00
Track Holder Arm	HT, PHT	\$607.00	\$716.00	\$692.00
Track Bumper Arm	OTB, POTB	\$612.00	\$721.00	\$697.00
Track Holder Bumper Arm	HTB, PHTB	\$634.00	\$743.00	\$719.00
Track Double Egress Single Step Frame	ODS *(Handed)	NA	NA	\$795.00
Track Double Egress Single Step Frame w/Bumper	ODSB *(Handed)	NA	NA	\$811.00
Track Double Egress Single Step Frame w/Holder	HDS *(Handed)	NA	NA	\$896.00
Track Double Egress Single Step Frame w/Holder	HDSB *(Handed)	NA	NA	\$918.00
Track Double Egress	OD *(Handed)	\$661.00	\$770.00	\$746.00
Track Double Egress w/Bumper	ODB *(Handed)	\$677.00	\$786.00	\$762.00
Track Double Egress w/Holder	HD *(Handed)	\$763.00	\$872.00	\$848.00
Track Double Egress w/Holder & Bumper	HDB *(Handed)	\$784.00	\$893.00	\$869.00

NOTES

* Please specify hand when ordering.

** Furnished standard with installation data sheet for use with #590 overhead holder. Please indicate on order if alternate data sheet is required.

DC-4 DOOR CLOSERS

SARGENT®

SPECIALTY CLOSERS

ASSA ABLOY

USA & Canada Prices Effective May 1, 2021

Concealed Closer			10BE/EB/ED/EN/EP/EAB/BSP/WSP
Closer Series	Arm	Arm Type - Handed - specify hand when ordering	Price
268	O	Concealed Track Arm	\$815.00
268	OB	Concealed Track Arm w/Bumper	\$858.00
268	H	Concealed Track Holder Arm	\$849.00
268	HB	Concealed Track Holder Arm w/Bumper	\$901.00
269	O	Concealed Track Arm	\$898.00
269	OB	Concealed Track Arm w/Bumper	\$942.00
278	OE	Exposed Standard Arm	\$691.00
278	H	Exposed Holder Arm	\$740.00

How to order - Example: 268 O EN RH

Security Package Closers – Complete Closer Package			10BE/EB/ED/EN/EP/EAB/BSP/WSP
Closer Series	Arm	Arm Type - Handed - specify hand when ordering	Price
268	CSP	Concealed with Track	\$982.00
268	CSPS	Single pole double throw door position switch	\$1,083.00
268	CSPD	Double pole double throw door position switch	\$1,097.00
269	CSP	Concealed with Track	\$1,095.00
269	CSPS	Single pole double throw door position switch	\$1,225.00
269	CSPD	Double pole double throw door position switch	\$1,244.00
281	SSP	Parallel Arm, heavy duty	\$796.00
281	SSO	Standard Arm, heavy duty	\$796.00
281	SSPT	Track - pull side	\$868.00
281	PSSPT	Track - push side	\$868.00

Note: The Security Package on the 281, 268 and 269 Door Closer Series consists of the door closer body, the handed metal cover or steel top plate, security closer arm or security track, and 6-Lobe security torx screws.

How to order - Example: 281 SSP EN RH

422 Cam Action Closer			10BE/EB/ED/EN/EP/EAB/BSP/WSP
Closer Series	Arm	Arm Type	Price
422	CTB2	Pull Side, Non-Hold Open	\$630.00
422	CTHB2	Pull Side, Hold Open	\$659.00
422	PCTB2	Push Side, Non-Hold Open (Handed)	\$630.00
422	PCHTB2	Push Side, Hold Open (Handed)	\$659.00

How to order - Example: 422 PCTB2 EN RH

Finish Options with Door Closers 1431, 268, 269, 278, 281, 422, 351 Series Closers	Finish 03/04/09/10/10B/ 10BL/14/15/20D/26/26D
Description	
Cover and arm 1, 2	Add \$574.00
Cover only 1	\$234.00
Arm only 1, 2	\$340.00
Finish Plate (268, 269, 278 Series) 04, 10B, 26D only	\$205.00
Brackets and Mounting Plates – Ordered Separately	\$104.00
Custom powder coat 1, 3	(Provide sample to factory for available colors and price.)
Set-up charge per color 1, 3	\$209.00 per order/per color
<hr/>	
Spray paint to match SARGENT standard colors (12 cans per case, all one color)	\$456.00 p/case

Notes

1. Closers/Cover

- A. All plated closers are supplied with metal covers which are handed. Specify RH or LH for handing.
- B. SRI (rust inhibiting process) not available with plated finishes. SRI available on select closer bodies only.
- C. For items or finishes not listed, consult factory for availability and pricing.
- D. Addition for metal cover is included in the plating charges.

2. Arms

- A. UO, UH, RO, RP9, RUO, Track arms and link arms are not available in plated finishes.
- B. Order O or H for standard applications and as P9 or PH9 for parallel arm applications.

3. Custom Powder Coat

- A. Handed metal covers must be used for powder coat finishes. Please indicate RH or LH.
- B. Addition for metal cover is included in the powder coat charges.
- C. The factory must be supplied with a color sample to match.
- D. All powder coat finish must be approved by the factory prior to ordering.

How to Order Plated Closers

Please note what finish option is required, if not spelled out plated cover only will be shipped.

Ex: 1 ea. 351 O x 03 x RH – Cover and Arm will be plated US3

1 ea. 351MC O x 03 x LH – Cover will be plated US3, Arm will be painted EAB

Special Finish Options

CPC	Clear Powder Coat over 26D – How to order: 351 x O x 26D x CPC	Add \$154.00
MPC	Bright Metallic Powder Coat finish – How to Order: 35 x O x MPC	\$73.00
MPC	MPC Set-up charge – Discounts do not apply.	\$139.00 per order
A set-up fee will be added to EACH purchase orders that lists non-standard sprayed or powder coat finishes.		\$857.00
Discount 50% only. Fee will appear as a separate line item on invoice: SETUPDCG		

Notes: All CPC and MPC orders will be handled as a special.

DC-6 DOOR CLOSERS

SARGENT®

ACCESSORIES

ASSA ABLOY

USA & Canada Prices Effective May 1, 2021

Accessories and Components of Door Closers		Part Number	10BE/EB/ED/EN/EP/EAB/BSP/WSP	Finishes
Description				
Corner Bracket		281W, 1431W		\$122.00
Mounting Plate		351A, 351B, 281B, 1431B		\$97.00
Drop Plate		281D, 351D, 1431D		\$97.00
Retrofit Plate		351L		\$112.00
Flush transom bracket for PS, PSH, P10, CPS, CPSH PH10 Arms		125VF		\$109.00
Support bracket for PS, PSH, P10, PH10, CPS, CPSH Arms on narrow frame		125V		\$55.00
Blade stop spacer kit for P9, PH9, PF9 Arms		581-1		\$47.00
Blade stop spacer kit for P10, PS, PSH, CPS, CPSH, PH10 Arms		581-2		\$78.00
Closer Repair Kit (1431)		582		\$64.00
Spacer block for single screw		63-0191		\$22.31 (Not finished)
Cover Plate		281J, 281J-2, 1431J		\$63.00
Hold Open Kit – for channel type		63-3903		\$52.54 (Not finished)
Hold Open Kit w/Bumper – for channel type		63-3904		\$82.64 (Not finished)
Arms Only 351, 281, 1431 Series (Includes Arm Screw Pack)				
Application				
Standard Wrought Arm (fits 1431 Series only)		25RO		\$123.00
Parallel Wrought Arm (fits 1431 Series only)		25RP9		\$123.00
Wrought Universal Arm (fits 1431 Series only)		25RUO		\$130.00
Standard Arm		25O, OLC, O8, OZ, OZA, OP		\$137.00
Parallel Arm		25P3, P3A, P4, P4A, P9		\$137.00
Standard Heavy Duty Arm		25O10		\$179.00
Parallel Arm Heavy Duty		25P10		\$179.00
Parallel Heavy Duty Drop Arm		25PD10		\$179.00
Universal Arm		25UO		\$142.00
Holder Arm (H8-Handed)		25H, H8, HZ, HZA		\$202.00
Parallel Holder Arm		25PH4, PH9		\$202.00
Universal Holder Arm		25UH		\$208.00
Parallel Holder Heavy Duty Arm (Handed)		25PH10		\$220.00
Standard Holder Heavy Duty Arm		25H10		\$220.00
Parallel Stop Heavy Duty Arm		25PS		\$214.00
Compression Stop Heavy Duty Arm		25CPS		\$344.00
Parallel Stop/Holder Heavy Duty Arm		25PSH		\$282.00
Compression Holder Heavy Duty Arm		25CPSH		\$410.00
▲ Arms supplied at standard 160 degree. Specify suffix (-125) for entry with 125 Degree option				
For example: 25F8-125 x EN x RH				
Complete Track Type Arms Includes Arm and Channel (351, 281, 1431 Series)				
Track Type Arm		25OT, POT, OTP		\$201.00
Pull Side/Push Side Non-hold Open Arm (Handed)		25CTB2, PCTB2 (422 Only)		\$328.00
Pull Side/Push Side Hold Open Arm (Handed)		25CTHB2, PCHTB2 (422 Only)		\$389.00
Track Type Arm/Holder Arm		25HT, PHT		\$231.00
Track Type Arm		25OTB, POTB		\$236.00
Track Type Arm/Holder Arm		25HTB, PHTB		\$258.00
Track Double Egress Single Step Frame Arm *(Handed)		25ODS		\$334.00
Track Double Egress Single Step Frame w/Bumper Arm *(Handed)		25ODSB		\$350.00
Track Double Egress Single Step Frame w/Holder Arm *(Handed)		25HDS		\$435.00
Track Double Egress Single Step Frame w/Holder Arm *(Handed)		25HDSB		\$457.00
Track Double Egress Arm (Handed)		25OD		\$285.00
Track Double Egress Arm w/Bumper (Handed)		25ODB		\$301.00
Track Double Egress Arm w/Holder (Handed)		25HD		\$387.00
Track Double Egress Arm w/Holder & Bumper (Handed)		25HDB		\$408.00
Regular arm conversion units- 351, 281, 1431 Series				
Parallel Arm Foot		125P9, PH9		\$30.00
Parallel Arm Foot		125P3, P4, 125PH4		\$45.00
Parallel Arm Foot		125P3A, P4A		\$49.00
Inverted Arm Foot		125OZ, OZA		\$53.00

Experience a safer
and more open world

Copyright © 2002-2021 Sargent Manufacturing Company, an ASSA ABLOY Group company. All rights reserved.
Reproduction in whole or in part without the express written permission of Sargent Manufacturing Company is prohibited.
Contact us at: 800-727-5477 or visit www.sargentlock.com. In Canada contact us at: 800-461-3007 or visit www.assaabloydss.ca

Components of Door Closers		
Standard- High Impact Non-Corrosive Cover Non-Handed		FINISH
Closer Series	Part #	10BE/ EB/ED/EN/EP/EAB/BSP/WSP
351	351C	\$45.00
281	281C	\$48.00
422/1431	1431C	\$45.00
Environmentally friendly ABS plastic cover		
281	281CEC	\$53.00
Metal Covers (Handed—specify RH or LH)		
351	*351CMC	\$68.00
281	*281CMC	\$75.00
1431/422	*1431CMC	\$70.00

*NOTE: When ordering metal covers only, specify arm type.

Closer Bodies Only		
Option Closer Series	Closer Series	10BE/EB/ED/EN/EP/EAB/BSP/WSP
CB- 351	351	\$450.00
CB- 281	281	\$462.00
**CB- 278	278	\$523.00
**CB- 268 x Arm Type	268 – Specify Arm when ordering	\$569.00
**CB- 269 x Arm Type	269 – Specify Arm when ordering	\$650.00
CB- 1431	1431	\$356.00
CB- 422	422	\$480.00

**Handing is required when ordering

DC-8 DOOR CLOSERS

SARGENT®

ASSA ABLOY

1331/1131 SERIES ADJUSTABLE SIZE 1-6

USA & Canada Prices Effective May 1, 2021

Option	Description	Price
EC	Environmentally friendly ABS plastic cover	\$5.00
1331 Series Door Closer	Finish	
Description	Arm	EB/ED/EN/EP/EAB
Standard Arm -	1331 JO	\$429.00
	1331 JOZ	\$429.00
	1331 JP9	\$429.00
	1331 JP10	\$460.00
	1331 JUO	\$435.00
	1331 JPS	\$505.00
	1331 JCPS	\$684.00
Holder Arm -	1331 JPH9	\$480.00
	1331 JUH	\$485.00
	1331 JH	\$480.00
	1331 JHZ	\$480.00
	1331 JPH10	\$520.00
	1331 JPSH	\$569.00
	1331 JCPSH	\$751.00

NOTE: Arms unique to 1331 Series Door Closers
JPH10 is handed. Please specify handing when ordering.

1331 Closer – Parts & Accessories		
Adjustable Size 1-6		
Description	Part Number	Price
Mortise Nuts – When Ordered w/Closer – No Charge	4TB	\$16.00
Drop Plate – For Parallel Arm	1331D	\$91.00
Mounting Plate (Top Jamb)	1331B	\$91.00
Standard Cover, High Impact, Non-Corrosive	1331C	\$33.00
Environmentally friendly ABS plastic cover	1331CEC	\$38.00
Body Only	CB-1331	\$303.00
Standard/Top Jamb Arm	25JO	\$150.00
Parallel Arm	25JP9	\$150.00
Standard/Top Jamb Hold Open Arm	25JH	\$200.00
	25JOZ	\$151.00
Hold Open	25JHZ	\$225.00
	25JPS	\$243.00
Hold Open	25JPSH	\$321.00
	25JP10	\$200.00
Hold Open	25JPH10	\$243.00
	25JCPS	\$407.00
Hold Open	25JCPSH	\$477.00
Parallel Hold Open Arm	25JPH9	\$194.00
Parallel Arm Bracket; Converts JO to JP9	125JP9	\$29.00
Parallel Arm Bracket; Converts JH to JPH9	125JPH9	\$29.00
Support bracket	125JV	\$31.00
Angle bracket	125JVF	\$54.00
Screw Pack for all 1331 Arms	61-2765	\$14.89

1131 Series Door Closer – Regular, Parallel and Top Jamb Mount		Finish
Description	Arm	EB/EN
Standard Arm -	1131 RU (Adjustable size 1-6)	\$264.00
Holder Arm -	1131 HU (Adjustable size 1-6)	\$314.00

NOTE: Supplied Standard with machine screws and Mortise Nuts for 1-3/4" doors and self-tapping screws.

NOTE: Arms unique to 1131 Series Door Closers

Closers packed to mount as parallel arm, top jamb, or standard mount.

Accessories		
60-0535	Cover ordered separately for 1131 Closer	\$17.00 Each

Experience a safer
and more open world

Copyright © 2002-2021 Sargent Manufacturing Company, an ASSA ABLOY Group company. All rights reserved.
Reproduction in whole or in part without the express written permission of Sargent Manufacturing Company is prohibited.
Contact us at: 800-727-5477 or visit www.sargentlock.com. In Canada contact us at: 800-461-3007 or visit www.assaabloydss.ca

USA & Canada Prices Effective May 1, 2021

Part No.	Description	Price	Part No.	Description	Price
01-0134	Machine screw #8-32 x 13/16"	\$0.32	* 63-2231	Main Arm & Swivel Assy (HZA-Arm)	\$79.64
01-0287	Set Screw (used w/63-3905)	\$0.74	* 63-2240	Main Arm & Link Assy. LH (F-Arms 160)	\$398.03
01-0864	Hole Plug (PS/PSH Arm)	\$1.94	* 63-2241	Main Arm & Link Assy. RH (F-Arms 160)	\$398.03
01-1028	Machine screw #8-32 x 1/4"	\$0.85	* 63-2242	Main Arm & Link Assy. LH (F-Arms 125)	\$398.03
* 01-1143	12-24 x 5/8" Screw	\$0.99	* 63-2243	Main Arm & Link Assy. RH (F-Arms 125)	\$398.03
01-1157	Cover Screw 8-32 x 1-1/4"	\$0.34	* 63-2245	Foot Bracket LH (PF9-Arm)	\$316.40
01-1190	Steel Screw	\$1.86	* 63-2246	Foot Bracket RH (PF9-Arm)	\$316.40
* 01-1191	Pan Hd Screw 10-24 x 3/8"	\$0.99	* 63-2270	Foot Assy. (P3-Arm)	\$79.64
* 01-1206	Cover Screw 8-32 x 5/16"	\$0.81	* 63-2272	Foot Assy. (P4A-Arm)	\$102.40
01-1248	Machine Screw 12-24 x 1-5/16"	\$1.77	* 63-2273	Foot Assy. (F8, O8-Arms)	\$68.14
01-1463	Adjusting Rod Screw	\$2.17	* 63-2274	Foot Assy. (P3A-Arm)	\$79.64
* 01-2300	12 x 1-1/2" Wood Screw	\$0.99	* 63-2289	Foot Assy. LH (H8-Arm)	\$128.84
01-2303	12 x 2-1/2" Wood FI Hd Screw	\$2.15	* 63-2290	Foot Assy. RH (H8-Arm)	\$128.84
01-2306	Wood Flat Hd Screw #12 x 3"	\$2.14	* 63-2295	Foot Assy. (P4-Arm)	\$90.97
01-3438	12-24 x 1-3/4" Track Mtg. Screw	\$1.77	* 63-2391	Screw Pack	\$27.37
01-3440	Flat Hd Screw 12-24 x 2-1/4"	\$1.77	* 63-2392	Screw Pack	\$27.37
* 01-3458	Flat Hd Screw 1/4-20 x 2-1/2"	\$1.86	* 63-2396	Screw Pack (Stop & Spacer Pack – PS & PSH)	\$29.48
* 01-3595	Screw 8-32 Unf x 1/4"	\$1.07	* 63-2398	Screw Pack (CPS)	\$80.43
01-4411	Screw 12-24 x 3/8"	\$0.70	* 63-2444	(POT) Track Assy. Only	\$250.27
01-4451	Screw 10-24 x 3/8"	\$1.86	* 63-2445	(PHT) Track Assy. Only	\$272.99
01-4503	#12-24 x 3/8" Pan Head Screw	\$10.57	* 63-2447	(OT) Track Assy. Only	\$250.27
01-9063	Washer Spindle	\$0.17	* 63-2448	(HT) Track Assy. Only	\$272.99
01-9204	Self drilling tapping case mounting screw	\$0.32	* 63-2468	Foot Assy. (F-Arm)	\$56.86
01-9210	Self drilling tapping case mounting screw	\$0.52	63-2487	Ft. Brkt and Bdy Assy (LH)	\$276.86
* 01-9145	Screw (pivot)	\$1.98	63-2488	Ft. Brkt and Bdy Assy (RH)	\$276.86
61-0007	165 Degree Fusible Link – replacement	\$23.37	* 63-2549	Main Arm & Link Assy. (OLC-Arm)	\$68.14
61-0010	125 Degree Fusible Link – replacement	\$23.37	* 63-2607	Main Arm & Link Assy. (O, O8, OZ, OZA, P3, P3A, P4A, P9, RP9, UO-Arms)	\$56.86
61-0211	Friction Disc (PH Arms)	\$2.75	63-2868	Smoke Detector	\$18.56
61-0293	Bushing	\$5.54	* 63-3070	MAIN ARM & SWIVEL ASSY	\$79.64
61-0294	Washer	\$0.75	63-3264	Channel assy. -268 OB	\$178.73
* 61-0308	Swivel arm screw	\$6.40	63-3265	Channel assy. - 268 H	\$257.36
* 61-2303	Foot Assy. (H, HZ, HZA, PH4, PH9, UH-Arms)	\$105.09	63-3266	Channel assy. - 268 HB	\$289.53
* 61-2761	JO Main Arm Assy.	\$47.23	63-3394	Main Arm Assy - 280 RH	\$84.22
* 61-2762	JH Main Arm Assy.	\$47.23	63-3395	Main Arm Assy 280- LH	\$84.22
* 61-2765	Screw Pack	\$14.89	* 63-3405	P9 Foot Assembly	\$24.56
* 63-0073	Main Arm Concealed - LH	\$143.54	63-3413	Switch and Plug Assembly	\$98.20
* 63-0157	Channel – OT/OTB/HT/HTB	\$147.41	63-3481	Screw Pack – for 281 "O" Arm	\$10.37
* 63-0159	Channel - POT/POTB/PHT/PHTB	\$128.84	63-3482	Track Screw pack	\$12.91
63-0191	Spacer (5th hole)	\$22.31	* 63-3487	CPSH arm mounting screw pack	\$89.34
* 63-0211	Stop Only	\$18.95	63-3493	Bumper Only (CPS, CPSH-Arms)	\$56.86
63-0377	Bumper	\$23.95	63-3620	268/278 Base Plate Assy. CPS	\$136.47
63-0396	Bumper stop	\$4.78	63-3640	268 Screw Pack	\$16.58
* 63-0516	Holder	\$102.40	63-3641	268 CSP/CSPS/CSPD Screw Pack	\$86.33
63-0555	Mounting Bracket	\$46.02	63-3642	Screw Pack	\$28.48
* 63-0641	Heavy Duty – Main Arm	\$45.56	* 63-3684	351 "O" Screw Pack	\$5.76
63-0678	Spring support	\$5.76	* 63-3656	Main arm assy LH	\$86.11
* 63-0682	Track End Cap	\$11.30	* 63-3657	Main arm assy RH	\$86.11
63-0694	Hex Wrench for Heavy Duty Arm	\$6.30	* 63-3727	P10 Arm & Brax	\$102.40
* 63-0700	Pivot	\$8.22	63-3788	Ball Insert Assy. - CPSH	\$15.89
63-2063	Spring slide assy.	\$53.22	* 63-3830	CPS Brax & Arm Assy.	\$269.52
* 63-2188	Main Arm Assy. Concealed (LH)	\$143.54	* 63-3833	PSH Brax & Arm Assy.	\$181.88
* 63-2189	Main Arm Assy. Concealed (RH)	\$143.54	* 63-3835	SP10 H/D Arm Assy.	\$242.18
* 63-2216	Foot Assy. (O, OLC, RO, UO, RUO-Arms)	\$45.56	* 63-3836	CPSH Arm & Brax	\$269.52
* 63-2217	Foot Assy. (OZ-Arm)	\$56.86	* 63-3837	PS H/D Brax & Arm Assy.	\$109.13
* 63-2218	Foot Assy. (OZA, FZA-Arms)	\$56.86	* 63-3839	PH10 Arm & Brax – LH	\$136.47
* 63-2230	Main Arm & Swivel Assy. (HZ-Arm)	\$79.64			

* Price listed are for painted finishes or non finishes. For plated finishes, please refer to page DC-5 for finish add.

DC-10 DOOR CLOSERS

SARGENT®

ASSA ABLOY

PARTS

USA & Canada Prices Effective May 1, 2021

Part No.	Description	Price
* 63-3840	PH10 Arm & Brax – RH	\$136.47
* 63-3901	Track Arm Asy. (to be used w/63-3905)	\$79.64
63-3905	Roller Asy. (used w/01-0287)	\$12.99
63-3923	268/281 Screw Pack (PSSPT)	\$47.88
63-3924	268/281 Screw Pack (SSPT)	\$57.46
63-3925	268/281 Screw Pack (SSP)	\$53.60
63-4332	Extended Wiring Harness	\$53.51
63-4335	268 CSPA/CSPD Circuit Tester	\$79.47
64-0026	Bearing	\$2.89
* 64-0050	Foot Bracket (PH4-Arm)	\$68.14
64-0175	Plastic Cover Support Spacer-1431	\$1.75
64-0180	Plastic Support for metal cover	\$4.78
* 64-2407	Screw Pack (1431-0)	\$27.37
64-2408	Screw Pack-Track Type	\$27.37
64-2409	Screw Pack (1431)	\$22.78

* Price listed are for painted finishes or non finishes. For plated finishes, please refer to page DC-5 for finish add.

Overhead Door Holders & Stops Options		
Options	Description	Price
CPC	Clear Powder Coat over 26D – Orders will continue to be handled as Special	\$140.00
31	For Doors more than 1-3/4" up to 2-1/4" thick – specify thickness when ordering	No Add
36	Torx Security Machine Screws for door 1-3/4" Thick ONLY	Add \$26.00

*Option available for Overhead Holders & Stops Only

Overhead Door Holders & Stops		EB/ED/EN/ EP/EAB	10BE/26D/ BSP/WSP	04/10/10B	03/09/10BL/ 15/20D/26
Catalog Number	Description				
597 thru 599	Add Suffix H or S (Surface Mount)	\$561.00	\$561.00	\$656.00	\$768.00
697 thru 699	Add Suffix H or S (Concealed Mount)	\$425.00	\$425.00	\$656.00	\$761.00

H-Hold-open w/stop **S**-Stop only

1536 thru 1539	Add Suffix F, H, or S (Concealed Mount)	\$194.00	\$194.00	\$245.00	\$316.00
1546 thru 1549	Add Suffix F, H, or S (Surface Mount)	\$224.00	\$224.00	\$309.00	\$378.00

F-Friction type holder **H**-Non-friction type Stop & Holder **S**-Stop only

Overhead Door Holders & Stops Accessories		EB/ED/EN/EP/EAB/ 10BE/26D/BSP/WSP	04/10/10B	03/09/10BL/ 15/20D/26
Catalog Number	Description			
145	Angle Bracket for 1540 Series	\$70.00	\$79.00	\$85.00
195	Angle Bracket for 590 Series (handed)	\$76.00	\$83.00	\$89.00
* 21-0104	Jamb Bracket Shim for 590 - 1/4" thick – order screws separately	\$29.82	\$37.78	\$45.69
* 01-3454	1/4-20 x 1-1/4" Machine Screw - used w/21-0104 Bracket	\$2.41	\$2.41	\$2.41
* 21-0198	Jamb Bracket Shim for 1540 - 1/4" thick – order screws separately	\$21.84	\$29.82	\$37.78
01-3436	12-24 x 1-1/4" Machine Screw - used w/21-0198 Bracket	\$2.05	\$2.05	\$2.05
* 21-0396	690H Turn Lever, for doors up to 1-3/8" to 1 3/4" thick	\$10.75	\$15.23	\$18.21
* 21-0397	690H Turn Lever, for doors 1-7/8" – 2-1/4" thick	\$11.63	\$16.11	\$19.10
21-0079	590 Thru-bolt for 1-1/4" – 2" Door	\$4.33	\$4.33	\$4.33
21-2019	1530 Series "H", "S", "F" Screw Pack	\$9.04	\$9.04	\$9.04

* Specify finish when ordering.

HS-2 HOLDERS & STOPS

SARGENT®

ELECTROMAGNETIC DOOR HOLDER

ASSA ABLOY

USA & Canada Prices Effective May 1, 2021

Electromagnetic Door Holder			
Part #	Description	Finish	Price
1560	Wall Mount, Surface Applied Wiring	EN	\$431.00
1561	Wall Mount, Concealed Wiring (in a junction box)	EN	\$413.00
1562	Floor Mount, Single Door	EN	\$735.00
1563	Floor Mount, Double Door	EN	\$960.00
Part #	Parts & Accessories Description	Finish	Price
52-0302	Surface Mounting Box	EN	\$112.83
52-0303	Wall Cover	EN	\$78.00
52-0304	Magnet Housing Cover - Single Floor	EN	\$391.62
52-0305	Magnet Housing Cover - Double	EN	\$547.60
52-0306	Magnet Support Bracket		\$38.18
52-0307	Magnet Housing Base, Single Floor	EN	\$238.96
52-0308	Magnet Housing Base, Double Floor	EN	\$351.77
52-0309	Floor Gasket		\$24.88
52-2570	Magnet - Wall Mount		\$207.41
52-2571	Magnet - Floor		\$177.52
52-2572	Door Armature		\$139.39
52-2573	Extension & Screw	EN	\$129.44
52-2574	Screw Kit (for 1561)	EN	\$34.84
52-2575	Screw Kit (for 1560)	EN	\$34.84
52-2576	Screw Kit - Single Floor	EN	\$92.92
52-2577	Screw Kit - Double Floor	EN	\$116.16

Experience a safer
and more open world

Copyright © 2002-2021 Sargent Manufacturing Company, an ASSA ABLOY Group company. All rights reserved.
Reproduction in whole or in part without the express written permission of Sargent Manufacturing Company is prohibited.
Contact us at: 800-727-5477 or visit www.sargentlock.com. In Canada contact us at: 800-461-3007 or visit www.assaabloydss.ca

TABLE OF CONTENTS

USA & Canada Prices Effective May 1, 2021

EXIT DEVICES

How to Order/ANSI Finish & Function Comparison ED-1

20 Series

20 Series Options..... ED-2

20 Series Reversible SVR & Rim Device ED-3

30 Series

30 Series Options..... ED-4

30 Series Reversible SVR & Rim Device ED-5

9898 Series

9898 Series Options..... ED-6

9898 Reversible Rim Device..... ED-7

80 Series

8300 Series Options..... ED-8

8300 Series Narrow Mortise Device ED-9

AD8400 Series Options..... ED-10

AD8400 Series Narrow Concealed Vertical Rod ED-11

MD8400 Series Options ED-12

MD8400 Series Narrow Concealed Vertical Rod..... ED-13

AD8500 Series Options..... ED-14

AD8500 Series Narrow Rim Device ED-15

8500 Series Options..... ED-16

8500 Series Concealed Vertical Rod – Metal Door ED-17

AD8600 Series Options..... ED-18

AD8600 Series Concealed Vertical Rod – Metal Door ED-19

MD8600 Series Options ED-20

MD8600 Series Concealed Vertical Rod – Wood Door ED-21

WD8600 Series Options..... ED-22

WD8600 Series Concealed Vertical Rod – Wood Door..... ED-23

LS, LP, LR8600 Series Options ED-24

LS, LP, LR8600 Series Concealed Vertical Rod
– Low Profile ED-25

8700 Series Options..... ED-26

8700 Series Surface Vertical Rod..... ED-27

NB8700 Series Options..... ED-28

NB8700 Series Surface Vertical Rod..... ED-29

FM8700 Series Options ED-30

FM8700 Series-Surface Vertical Rod-Complies with
FEMA 361 ED-31

8888 Series Options ED-32

8800 Series Rim..... ED-33

8888 Series Options..... ED-34

8888 Reversible Rim Exit Device..... ED-35

8900 Series Options..... ED-36

8900 Series Mortise ED-37

90 Series

9400 Series Options..... ED-38

9400 Series Narrow Stile Concealed Vertical Rod ED-39

9700 Exit Options..... ED-40

9700 Series Surface Vertical Rod..... ED-41

9800 Series Options..... ED-42

9800 Series Rim..... ED-43

9900 Series Options..... ED-44

9900 Series Mortise ED-45

Trim

ET Standard, Coastal Series, and Studio Collection (Except Gramercy Series)

Lever Control Trim ED-46

Freewheeling ET Standard, Coastal Series, and Studio Collection (Except Gramercy Series)

Lever Control Trim ED-47

ET Gramercy Series Lever Control Trim..... ED-48

Freewheeling ET Gramercy Series Lever Control Trim..... ED-49

Pull & Thumbpiece Trim, Dummy Rails, & Misc. Trims

Pull & Thumbpiece Trim..... ED-50

Dummy Rails/AVT Trim, Aux Control Trim ED-51

Mullions & Accessories

Mullions & Accessories ED-52 to ED-53

Accessories ED-54 to ED-55

Strikes ED-56

TABLE OF CONTENTS

USA & Canada Prices Effective May 1, 2021

Parts

01-0007 to 28-2014.....	ED-57
28-2026 to 68-0618.....	ED-58
68-0632 to 68-1326.....	ED-59
68-1363 to 68-2460.....	ED-60
68-2461 to 68-2925.....	ED-61
68-2926 to 68-3311.....	ED-62
68-3314 to 68-3941.....	ED-63
68-3945 to 68-4341.....	ED-64
68-4342 to 68-4688.....	ED-65
68-4689 to 68-5554.....	ED-66
68-5559 to 94-2379.....	ED-67
94-2380 to 97-2038.....	ED-68
97-2039 to 99-0088.....	ED-69
99-0098 to 99-2526.....	ED-70

GENERAL INFORMATION

USA & Canada Prices Effective May 1, 2021

How To Order

Step	Description	Example
Quantity	Each	10 Ea.
Option	Consult proper section for options available	10 Ea. 12-
Series	20, 30, 80, 90	10 Ea. 12-87
Function	Consult proper section for functions available	10 Ea. 12-8713
Rail Size	E, F, J, G, Consult catalog for description	10 Ea. 12-8713 G
Trim	Consult proper section for trims available	10 Ea. 12-TB 8713 G ETL
Thru Bolts	If required	10 Ea. 12-TB 8713 G ETL
Strike	Specify if other than standard	10 Ea. 12-TB 8713 G ETL 653
Hand	Consult proper section for handing required	10 Ea. 12-TB 8713 G ETL 653 RHR
Finish	Consult proper section for finishes available	10 Ea. 12-TB 8713 G ETL 653 RHR 32D
Misc. Options	Consult proper section for options available	10 Ea. 12-TB 8713 G ETL 653 RHR 32D x 7'6" Door Ht.
Split Finishes	Specify outside finish first	10 Ea. 12-8813 F ETL US10B/32D RHR

ANSI Finish and Function Comparison

Function		Finish		
SARGENT	ANSI	SARGENT	ANSI	Description
10	01	US3	605	Polished Brass
28	01	US4	606	Satin Brass
88	01	US9	611	Polished Bronze
98	01	US10	612	Satin Bronze
10-DT	02	US10B	613	Oxidized Satin Bronze/Oil Rubbed
28-DT	02	US10BE	613E	Dark Oxidized Satin Bronze - Equivalent
88-DT	02	US10BL	—	Oxidized Satin Bronze/Lacquered
98-DT	02	US14	618	Bright Nickel, Clear Coated
04	03	US15	619	Satin Nickel Plate
10-DT (16-Option)	04	US20D	—	Dark Statuary Bronze Powder Coated
88-DT (16-Option)	04	US26	625	Polished Chrome
63	05	US26D	626	Satin Chrome
62	06	US32	629	Polished Stainless Steel
66	07	US32D	630	Satin Stainless Steel
13	08	BSP	—	Black Suede Powder Coat
06	09	WSP	—	White Suede Powder Coat
16	10	EB	—	Powder Coated to match 10B
10 x Auxiliary Control (13)	11	ED	—	Powder Coated to match 20D
10 x Auxiliary Control (06)	12	EN	—	Powder Coated to match US28
		EP	—	Powder Coated to match 10
		ED	—	Sprayed to match 20D
		EAB	—	Powder Coated Satin Brass Enamel

ED-2 EXIT DEVICES

SARGENT®

ASSA ABLOY

20 SERIES OPTIONS

USA & Canada Prices Effective May 1, 2021

Options	Description	Price
10	SARGENT Signature System	\$63.00 /cyl.
11	SARGENT XC Key System (not available w/10, 22, KESO, SC, & SE options)	No addition
*1160	SARGENT XC Large Format Interchangeable Plastic Disposable Construction Core	No addition
*1163	SARGENT XC Large Format Interchangeable Core Cylinder – Includes masterkeying charges	\$83.00
*1164	SARGENT XC Large Format Interchangeable Construction Core Cylinder	\$83.00
*1170	Small Format interchangeable disposable construction core - to accept 7 Pin XC permanent core	No addition
*11727P	Small Format interchangeable keyed construction core - to accept 7 Pin XC permanent core	\$75.00
*11737P	Small Format interchangeable core - to accept 7 pin XC permanent core	\$75.00 / cyl.
12	UL Fire Label Exit Devices (not available with 16- option)	\$178.00
16	Cylinder lockdown feature (not available with 12- option)	\$133.00
21	SARGENT Construction Key System (lost ball)	\$16.00 /cyl.
22	SARGENT Construction Key System (split key)	\$32.00 /cyl.
*60	SARGENT Large Format Interchangeable Plastic Disposable Construction Core	No addition
*63	SARGENT Large Format Interchangeable Core Cylinder includes master and grandmaster keying charge	\$83.00 /cyl.
*64	SARGENT Large Format Interchangeable Construction Core Cylinder	\$83.00
*6573	Small Format 6-Pin uncombined core	\$65.00 /cyl.
*65737P	Small Format 7-Pin uncombined core	\$65.00 /cyl.
*70	Small Format Interchangeable disposable plastic construction core	No addition
*72	Small Format Interchangeable construction core (7-pin with 11 option)	\$75.00
*73	Small Format 6-Pin Interchangeable core	\$75.00 /cyl.
*737P	Small Format 7-Pin Interchangeable core	\$75.00 /cyl.
BR	SARGENT Bump Resistant Cylinders (N/A w/10, 22, 30, 60, 63, 64, 70, 72, 73, 737P, KESO, SC, SE)	\$25.00 /cyl.
DG1	Patented Degree DG1 Key System	No addition
DG160	Hardware prepared for DG1-6300 Lg. Format IC cores, supplied with temporary plastic construction cores	No addition
DG163	Patented Degree DG1 Large Format Interchangeable Core Cylinder - Includes master keying charges	\$83.00
DG164	Hardware prepared for DG1-6300 Lg. Format IC cores, supplied with temporary keyed construction cores	\$83.00
DG2	Patented Degree DG2 Key System incorporating a locking sidebar	\$63.00/cyl.
DG260	Hardware prepared for DG2-6300 Lg. Format IC cores, supplied with temporary plastic construction cores	No addition
DG263	Patented Degree DG2 Large Format Interchangeable Core Cylinder - Includes master keying charges	\$146.00
DG264	Hardware prepared for DG2-6300 Lg. Format IC cores, supplied with temporary keyed construction cores	\$83.00
DG3	Patented Degree DG3 Key System incorporating a locking sidebar and UL437 listed	\$89.00/cyl.
DG360	Hardware prepared for DG3-6300 Lg. Format IC cores, supplied with temporary plastic construction cores	No addition
DG363	Patented Degree DG3 Large Format Interchangeable Core Cylinder - Includes master keying charges	\$172.00
DG364	Hardware prepared for DG3-6300 Lg. Format IC cores, supplied with temporary keyed construction cores	\$83.00
LC	Less Cylinder Deduct for LL, LP, LB, OB Trims	-\$94.00/cyl.
LC	Less Cylinder Deduct for GTB, TP, or 16 Option	-\$96.00/cyl.
SC	Schlage C Keyway Cylinder 0-Bitted (Rim & #41 Mortise Cylinder Only & Lever Trim Only)	No addition
SE	Schlage E Keyway Cylinder 0-Bitted (Rim & #41 Mortise Cylinder Only & Lever Trim Only)	No addition
TB	For 2727 Series	\$78.00
TB	For 2828 Series	\$26.00

* Note: For lever trim listed on ED-3 only.

Vertical Rod Device to 96" Height	No addition
Concealed/Surface Vertical Rod Device over 96" to 120" Height	\$64.00

Refer to catalog for max. door height availability on fire rated exit devices.

Experience a safer
and more open world

Copyright © 2002-2021 Sargent Manufacturing Company, an ASSA ABLOY Group company. All rights reserved.
Reproduction in whole or in part without the express written permission of Sargent Manufacturing Company is prohibited.
Contact us at: 800-727-5477 or visit www.sargentlock.com. In Canada contact us at: 800-461-3007 or visit www.assaabloydss.ca

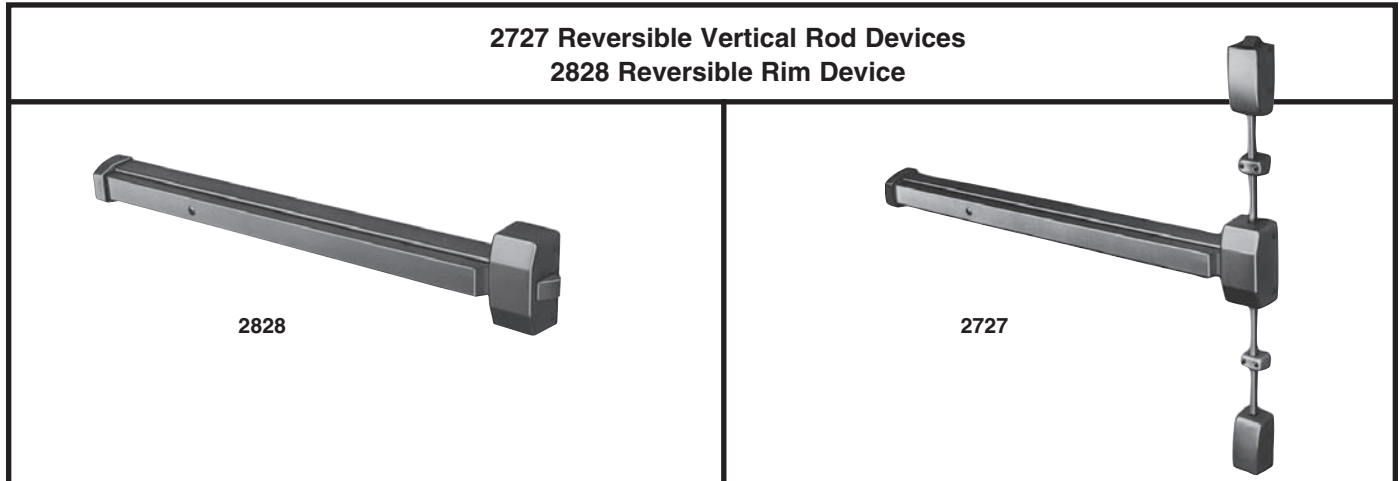

<u>Less Trim</u>				<u>Finish</u>
Device				EN/EB/ED/EP/EAB
2727				\$1,458.00
2828				\$793.00
<u>20 Series Trim</u>		<u>03/04/09/10/10B/10BE/ 10BL/14/15/26/26D/BSP/WSP</u>		<u>EN/EB/ED/ EP/EAB</u>
Function * Note: For use with 2828 Device only		Trim		
28C	Key locks/Unlocks trim (13)	LL, LP, LB		
28D	Dummy Trim (lever) (10)	LL, LP, LB	\$384.00	
28K	Key retracts Latchbolt (04)	LL, LP, LB		
28L	Trim always operable (15)	LL, LP, LB		
28N	Key operates lever (06)	LL, LP, LB		
28C	Key locks/Unlocks trim (13)	OB		
28K	Key retracts latchbolt (04)	OB	\$249.00	
28L	Trim always operable (15)	OB		
810	Dummy Trim (pull)	GTB		\$109.00
802	Blank Plate	GTB		\$105.00
814	Key retracts latchbolt (pull)	HTB		\$214.00
<u>Thumbpiece Trim (not retrofittable to Exits shipped prior to February 25, 2000)</u>				<u>EN/EB/EAB</u>
810	Dummy Trim	TP		\$144.00
866	Key locks/unlocks thumbpiece	TP		\$346.00
814	Key retracts latch	TP		\$316.00
828	Trim always operable	TP		\$178.00
<u>Thru Bolt Application</u>		<u>Pack Part #</u>		<u>Finish</u>
		1-3/4" Dr.	2-1/4" Dr.	10B/10BE/26D/BSP/WSP
2828, 12-2828	4	28-2024	28-2025	\$29.00 Pack
2727	14	28-2031	28-2032	\$105.00 Pack
12-2727	16	28-2087	28-2088	\$118.00 Pack

ED-4 EXIT DEVICES

SARGENT®

ASSA ABLOY

30 SERIES OPTIONS

USA & Canada Prices Effective May 1, 2021

Options	Description	Price
10	SARGENT Signature System	\$63.00 /cyl.
11	SARGENT XC Key System (not available w/10, 22, KESO, SC, & SE options)	No addition
*1160	SARGENT XC Large Format Interchangeable Plastic Disposable Construction Core	No addition
*1163	SARGENT XC Large Format Interchangeable Core Cylinder – Includes masterkeying charges	\$83.00
*1164	SARGENT XC Large Format Interchangeable Construction Core Cylinder	\$83.00
*1170	Small Format interchangeable disposable construction core - to accept 7 Pin XC permanent core	No addition
*11727P	Small Format interchangeable keyed construction core - to accept 7 Pin XC permanent core	\$75.00
*11737P	Small Format interchangeable core - to accept 7 pin XC permanent core	\$75.00 / cyl.
12	UL Fire Label Exit Devices (not available with 16- option)	\$178.00
16	Cylinder lockdown feature (not available with 12- option)	\$133.00
21	SARGENT Construction Key System (lost ball)	\$16.00 /cyl.
22	SARGENT Construction Key System (split key)	\$32.00 /cyl.
55	Signal Switch in Rail	\$241.00
*60	SARGENT Large Format Interchangeable Plastic Disposable Construction Core	No addition
*63	SARGENT Large Format Interchangeable Core Cylinder includes master and grandmaster keying charge	\$83.00 /cyl.
*64	SARGENT Large Format Interchangeable Construction Core Cylinder	\$83.00
*6573	Small Format 6-Pin uncombined core	\$65.00 /cyl.
*65737P	Small Format 7-Pin uncombined core	\$65.00 /cyl.
*70	Small Format Interchangeable disposable plastic construction core	No addition
*72	Small Format Interchangeable construction core (7-pin with 11 option)	\$75.00
*73	Small Format 6-Pin Interchangeable core	\$75.00 /cyl.
*737P	Small Format 7-Pin Interchangeable core	\$75.00 /cyl.
BR	SARGENT Bump Resistant Cylinders (N/A w/10, 22, 30, 60, 63, 64, 70, 72, 73, 737P, KESO, SC, SE)	\$25.00 /cyl.
DG1	Patented Degree DG1 Key System	No addition
DG160	Hardware prepared for DG1-6300 Lg. Format IC cores, supplied with temporary plastic construction cores	No addition
DG163	Patented Degree DG1 Large Format Interchangeable Core Cylinder - Includes master keying charges	\$83.00
DG164	Hardware prepared for DG1-6300 Lg. Format IC cores, supplied with temporary keyed construction cores	\$83.00
DG2	Patented Degree DG2 Key System incorporating a locking sidebar	\$63.00/cyl.
DG260	Hardware prepared for DG2-6300 Lg. Format IC cores, supplied with temporary plastic construction cores	No addition
DG263	Patented Degree DG2 Large Format Interchangeable Core Cylinder - Includes master keying charges	\$146.00
DG264	Hardware prepared for DG2-6300 Lg. Format IC cores, supplied with temporary keyed construction cores	\$83.00
DG3	Patented Degree DG3 Key System incorporating a locking sidebar and UL437 listed	\$89.00/cyl.
DG360	Hardware prepared for DG3-6300 Lg. Format IC cores, supplied with temporary plastic construction cores	No addition
DG363	Patented Degree DG3 Large Format Interchangeable Core Cylinder - Includes master keying charges	\$172.00
DG364	Hardware prepared for DG3-6300 Lg. Format IC cores, supplied with temporary keyed construction cores	\$83.00
LC	Less Cylinder Deduct for LL, LP, LB, OB Trims	-\$94.00/cyl.
LC	Less Cylinder Deduct for GTB, TP, or 16 Option	-\$96.00/cyl.
NB	No Bottom Rod for 3727 Devices	No Addition
SC	Schlage C Keyway Cylinder 0-Bitted (Rim & #41 Mortise Cylinder Only & Lever Trim Only)	No addition
SE	Schlage E Keyway Cylinder 0-Bitted (Rim & #41 Mortise Cylinder Only & Lever Trim Only)	No addition
TB	For 3727 Series	\$78.00
TB	For 3828 Series	\$26.00

*Note: For lever trim listed on ED-5 only.

Vertical Rod Device to 96" Height No addition

Concealed/Surface Vertical Rod Device over 96" to 120" Height \$64.00

Refer to catalog for max. door height availability on fire rated exit devices.

Experience a safer
and more open world

Copyright © 2002-2021 Sargent Manufacturing Company, an ASSA ABLOY Group company. All rights reserved.
Reproduction in whole or in part without the express written permission of Sargent Manufacturing Company is prohibited.
Contact us at: 800-727-5477 or visit www.sargentlock.com. In Canada contact us at: 800-461-3007 or visit www.assaabloydss.ca

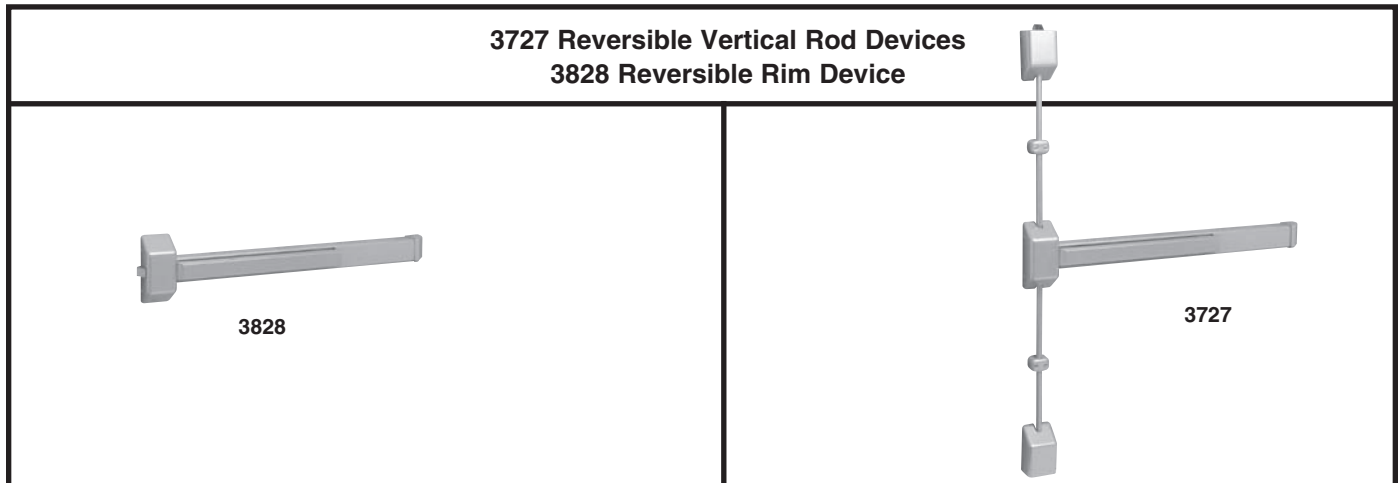

<u>Less Trim</u>		Finish		
Device		EN/EB/ED/EP/EAB		
3727		\$1,038.00		
3828		\$594.00		
<u>30 Series Trim</u>		EN/EB/ED/EP/EAB		
Function * Note: For use with 3828 Device only Trim		03/04/09/10/10B/10BE/ 10BL/14/15/26/26D/BSP/WSP		
28C	Key locks/Unlocks trim (13)	LL, LP, LB		
28D	Dummy Trim (lever) (10)	LL, LP, LB	\$384.00	
28K	Key retracts Latchbolt (04)	LL, LP, LB		
28L	Trim always operable (15)	LL, LP, LB		
28N	Key operates lever (06)	LL, LP, LB		
28C	Key locks/Unlocks trim (13)	OB		
28K	Key retracts latchbolt (04)	OB	\$249.00	
28L	Trim always operable (15)	OB		
810	Dummy Trim (pull)	GTB	\$109.00	
802	Blank Plate	GTB	\$105.00	
814	Key retracts latchbolt (pull)	HTB	\$214.00	
<u>Thumbpiece Trim</u>		EN/EB/EAB		
810	Dummy Trim	TP	\$144.00	
866	Key locks/unlocks thumbpiece	TP	\$346.00	
814	Key retracts latch	TP	\$316.00	
828	Trim always operable	TP	\$178.00	
<u>Thru Bolt Application</u>		Pack Part #		Finish
No. Bolts per Pack		1-3/4" Dr.	2-1/4" Dr.	10B/26D
3828, 12-3828	4	28-2024	28-2025	\$29.00 Pack
3727	14	28-2031	28-2032	\$105.00 Pack
12-3727	16	28-2087	28-2088	\$118.00 Pack

ED-6 EXIT DEVICES

SARGENT®

ASSA ABLOY

9898 SERIES OPTIONS

USA & Canada Prices Effective May 1, 2021

Options	Description	Price
10	SARGENT Signature System	\$63.00 /cyl.
11	SARGENT XC Key System (not available w/10, 22, KESO, SC, & SE options)	No addition
1160	SARGENT XC Large Format Interchangeable Plastic Disposable Construction Core	No addition
1163	SARGENT XC Large Format Interchangeable Core Cylinder – Includes masterkeying charges	\$83.00
1164	SARGENT XC Large Format Interchangeable Construction Core Cylinder	\$83.00
21	SARGENT Construction Key System (lost ball)	\$16.00 /cyl.
22	SARGENT Construction Key System (split key)	\$32.00 /cyl.
42	Reinforced Crossbar	\$77.00
60	SARGENT Large Format Interchangeable Plastic Disposable Construction Core	No addition
63	SARGENT Large Format IC Cylinder includes master and grandmaster keying charge	\$83.00 /cyl.
64	SARGENT Large Format Interchangeable Construction Core Cylinder	\$83.00
81	Cylinder to accept Keso (83) and Keso F1 (F183) removable core – no core provided	No addition
F182	SARGENT Keso Security, patent pending, cylinder – new key systems	\$91.00 /cyl.
F183	SARGENT Keso Security, patent pending, removable core cylinder – new key systems	\$130.00 /cyl.
82	SARGENT Keso Security Cylinder (existing key systems only)	\$91.00 /cyl.
83	SARGENT Keso Security Removable Core Cylinder (existing key systems only)	\$130.00 /cyl.
84	SARGENT Keso Security Removable Construction Core Cylinder	See CK-18
BR	SARGENT Bump Resistant Cylinders (not available w/10, 22, 30, 60, 63, 64, 70, 72, 73, 737P, KESO, SC, SE)	\$25.00 /cyl.
CPC	Clear Powder Coat – Recommended for exit devices used in full exterior application and highly corrosive areas with 32 and 32D finishes.	\$232.00
DG1	Patented Degree DG1 Key System	No addition
DG160	Hardware prepared for DG1-6300 Lg. Format IC cores, supplied with temporary plastic construction cores	No addition
DG163	Patented Degree DG1 Large Format Interchangeable Core Cylinder - Includes master keying charges	\$83.00
DG164	Hardware prepared for DG1-6300 Lg. Format IC cores, supplied with temporary keyed construction cores	\$83.00
DG2	Patented Degree DG2 Key System incorporating a locking sidebar	\$63.00/cyl.
DG260	Hardware prepared for DG2-6300 Lg. Format IC cores, supplied with temporary plastic construction cores	No addition
DG263	Patented Degree DG2 Large Format Interchangeable Core Cylinder - Includes master keying charges	\$146.00
DG264	Hardware prepared for DG2-6300 Lg. Format IC cores, supplied with temporary keyed construction cores	\$83.00
DG3	Patented Degree DG3 Key System incorporating a locking sidebar and UL437 listed	\$89.00/cyl.
DG360	Hardware prepared for DG3-6300 Lg. Format IC cores, supplied with temporary plastic construction cores	No addition
DG363	Patented Degree DG3 Large Format Interchangeable Core Cylinder - Includes master keying charges	\$172.00
DG364	Hardware prepared for DG3-6300 Lg. Format IC cores, supplied with temporary keyed construction cores	\$83.00
SG	MicroShield® an antimicrobial powder coat (Not Available with 10B finish)	\$88.00
TB	Thru-bolt	\$26.00

Notes:

Center Bearing Bracket for door 48" and over, order using part 98-2162 x finish \$433.00

9898 REVERSIBLE RIM DEVICE

USA & Canada Prices Effective May 1, 2021



<u>Less Trim</u>		<u>Finish</u>	
Device	10BE/32D/BSP/WSP	03/04/09/10/10B/10BL/20D/32	
9898	\$1,907.00	\$2,467.00	

<u>9898 Series Trim</u>			<u>All Finishes</u>
Function	Trim	Description	
802	PTB	Blank Plate	\$313.00
810	PTB, STS	Dummy Trim	
814	PTB, STS	Key retracts latchbolt	\$461.00
866	PTB, STS	Key locks/Unlocks thumb piece	

8300 SERIES OPTIONS

USA & Canada Prices Effective May 1, 2021



Options	Description	Price
10	SARGENT Signature System	\$63.00 / cyl.
11	SARGENT XC Key System (not available w/10, 22, KESO, SC, & SE options)	No addition
1160	SARGENT XC Large Format Interchangeable Plastic Disposable Construction Core	No addition
1163	SARGENT XC Large Format Interchangeable Core Cylinder – Includes masterkeying charges	\$83.00
1164	SARGENT XC Large Format Interchangeable Construction Core Cylinder	\$83.00
1170	Small Format interchangeable disposable construction core - to accept 7 Pin XC permanent core	No addition
11727P	Small Format interchangeable keyed construction core - to accept 7 Pin XC permanent core	\$75.00
11737P	Small Format interchangeable core - to accept 7 pin XC permanent core	\$75.00 / cyl.
12	UL Fire Label Exit Devices (not available with 16- & HK options)	\$184.00
16	Cylinder lockdown feature in rail (not available with 12-, 57-, 59-, AL- options)	\$133.00
19	80 Series pushbar without Lexan touchpad	No addition
21	SARGENT Construction Key System (lost ball)	\$16.00 / cyl.
22	SARGENT Construction Key System (split key)	\$32.00 / cyl.
23	ANSI flat lip strike (8300, 8900, 9900, including 12-Option)	No addition
31	For doors greater than 1-3/4" and up to 2-1/4" (including those with auxiliary controls) For doors over 2-1/4" For doors with panels (See catalog for ordering details)	No addition Consult Factory No addition
36	6 Lobe security head screws	\$49.00
37	Spanner head screws	\$31.00
43	Flush End Cap	No addition
* 53	Latchbolt Monitor Switch – available with 55, 56, 57, 58, AL options)	\$256.00
54	Internal Micro Switch in ET Control	\$232.00
* 55	Signal Switch in Rail	\$241.00
* 56	Remote Dogging / Latch Retraction (Minimum door width for narrow stile is 26" and wide stile is 28")	\$852.00
* HK56	Latch Retraction with Hex Key Dogging	\$852.00
* 57	Delayed Action(Magnet ordered separate)	\$1,407.00
* 58	Electric Dogging	\$487.00
* 59	Electroguard (Not available with HC-, 16-, 53-, 55-, 56-, 57-, 58- Options)	\$1,723.00
* BC59	Electroguard Boca Code (Needs Door Status Switch), (Not available with HC-, 16-, 53-, 55-, 56-, 57-, 58- Options)	\$1,829.00
60	SARGENT Large Format Interchangeable Plastic Disposable Construction Core	No addition
63	SARGENT Large Format Interchangeable Core Cylinder includes master and grandmaster keying charge	\$83.00 / cyl.
64	SARGENT Large Format Interchangeable Construction Core Cylinder	\$83.00
6573	Small Format 6 Pin Uncombined Core	\$65.00 / cyl.
65737P	Small Format 7 Pin Uncombined Core	\$65.00 / cyl.
70	Small Format Interchangeable Disposable plastic construction core	No addition
72	Small Format Interchangeable 6-Pin Construction Core (7-pin with 11 option)	\$75.00
73	Small Format 6-Pin interchangeable core	\$75.00 / cyl.
737P	Small Format 7-pin interchangeable core,	\$75.00 / cyl.
76	Tactile Warning - Milled Outside Lever (Not available with Studio, Coastal and the A Levers)	\$77.00
81	Cylinder to accept Keso (83) and Keso F1 (F183) removable core – no core provided	No addition
F182	SARGENT Keso Security, patent pending, cylinder – new key systems	\$91.00 / cyl.
F183	SARGENT Keso Security, patent pending, removable core cylinder – new key systems	\$130.00 / cyl.
82	SARGENT Keso Security Cylinder (existing key systems only)	\$91.00 / cyl.
83	SARGENT Keso Security Removable Core Cylinder (existing key systems only)	\$130.00 / cyl.
84	SARGENT Keso Security Removable Construction Core Cylinder	See CK-18
85	Tactile Warning - Abrasive Strip Inside Push Rail	\$101.00
86	Tactile Warning - Abrasive Coating Outside Lever	\$47.00
87	Tactile Warning - Abrasive Strip on Inside Push Rail & Coating on Outside Lever	\$148.00
* AL	Alarmed (not available with HC, HC4, 16-, 56- thru 59- options) (minimum Dr width 36")	\$595.00
BR	SARGENT Bump Resistant Cylinders (N/A w/10, 22, 30, 60, 63, 64, 70, 72, 73, 737P, KESO, SC, SE)	\$25.00 /cyl.
CPC	Clear Powder Coat – Recommended for exit devices used in full exterior application and highly corrosive areas with 32 and 32D finishes.	\$232.00
DG1	Patented Degree DG1 Key System	No addition
DG160	Hardware prepared for DG1-6300 Lg. Format IC cores, supplied with temporary plastic construction cores	No addition
DG163	Patented Degree DG1 Large Format Interchangeable Core Cylinder - Includes master keying charges	\$83.00
DG164	Hardware prepared for DG1-6300 Lg. Format IC cores, supplied with temporary keyed construction cores	\$83.00
DG2	Patented Degree DG2 Key System incorporating a locking sidebar	\$63.00/cyl.
DG260	Hardware prepared for DG2-6300 Lg. Format IC cores, supplied with temporary plastic construction cores	No addition
DG263	Patented Degree DG2 Large Format Interchangeable Core Cylinder - Includes master keying charges	\$146.00
DG264	Hardware prepared for DG2-6300 Lg. Format IC cores, supplied with temporary keyed construction cores	\$83.00
DG3	Patented Degree DG3 Key System incorporating a locking sidebar and UL437 listed	\$89.00/cyl.
DG360	Hardware prepared for DG3-6300 Lg. Format IC cores, supplied with temporary plastic construction cores	No addition
DG363	Patented Degree DG3 Large Format Interchangeable Core Cylinder - Includes master keying charges	\$172.00
DG364	Hardware prepared for DG3-6300 Lg. Format IC cores, supplied with temporary keyed construction cores	\$83.00
LC	Less Cylinder	-\$96.00/cyl.
LD	Less Dogging	No addition
* PL	SARGuide™ PL – Photoluminescent Coating – (Pushbar w/o Lexan Touchpad - 19 option is supplied as standard)	\$376.00
SC	Schlage C Keyway Cylinder 0 Bitted (Rim and # 41 Mortise Cylinder Only)	No addition
SE	Schlage E Keyway Cylinder 0 Bitted (Rim and # 41 Mortise Cylinder Only)	No addition
SG	MicroShield® an antimicrobial powder coat (not available with 10B)	\$88.00
TB	Thru Bolt	\$26.00
* TL	SARGuide™ – Illuminated Touchpad (not available AL, 57, 59 options)	\$232.00

NOTES: FLW NOT available in stainless steel. Cylinders not included when ordered less trim.

* Exact door width required when ordering.

USA & Canada Prices Effective May 1, 2021



8300 Series-Narrow Stile Mortise Device		
 ET Control	 ET Control	 PTB
Standard Levers: A-B-E-F-J-L-P-W Coastal Levers: G-R-S-Y All Studio Collection Levers (Except Gramercy, Wooster Square, & Grant Park)	Gramercy Series: RAG-RAL-RAM-RAS-RCM-REM-RGM Wooster Square: H001-H002-H003-H004-H005-H006 Grant Park: H007-H008-H009-H010-H011	STS-MAL-FLL-FLW
Finishes listed below are for the exit device. Refer to catalog for available trims, trim finishes and how to order.		

8300 Series		Finish					
Function	Description	10BE/32D/ BSP/WSP	03/04/09/10/10B/ 10BL/20D/32	10BE/32D/ BSP/WSP	03/04/09/10/10B/ 10BL/20D/32	10BE/32D/ BSP/WSP	03/04/09/10/10B/ 10BL/20D/32
8310	Exit Only / No Trim	\$2,716.00	\$2,868.00				
8310	Dummy Trim (Lever rigid)						
8304	Key Retracts Latchbolt (Lever rigid)*	\$3,476.00	\$3,628.00	\$3,719.00	\$3,871.00	\$3,177.00	\$3,329.00
8313	Key locks/unlocks control						
8315	Trim always operable						
8328	Thumb piece always operable					\$3,247.00	\$3,399.00
8363	Key locks/unlocks thumb piece						
8300 Series With Freewheeling Trim							
8340	Dummy Trim (Lever rotates)						
8343	Key engages/disengages lever	\$3,476.00	\$3,628.00	\$3,719.00	\$3,871.00		
8344	Key retracts latchbolt (Lever rotates)*						
8300 Series With Electro-Mechanical							
8373	Fail Safe 12v or 24v*	\$3,788.00	\$3,940.00	\$3,981.00	\$4,133.00		
8374	Fail Secure 12v or 24v*						
8375	Fail Safe 12v or 24v*	\$4,045.00	\$4,197.00	\$4,228.00	\$4,380.00		
8376	Fail Secure 12v or 24v*						

Specify voltage required when ordering.

Thru Bolt Application	Pack Part #		Finish	
	No. Bolts per Pack	1-3/4" Dr.	2-1/4" Dr.	03/04/09/10/10B/10BE/10BL/20D/26D/BSP/WSP
8300, 12-8300	4	68-2521	68-2570	\$25.00 Pack

NOTES:

*Not available with Arrow, Best, Falcon Interchangeable core options, SC and SE on ET trim cylinders.

FLW is not available in 32 & 32D finish.

Cylinders not included when ordered less trim except for 04 function.

15 or 26D finishes are available on outside trim only, the exit devices will be supplied in 32D.

14 or 26 Finishes are available on outside trim only, the exit devices will be supplied in 32 finish.

AD8400 SERIES OPTIONS

USA & Canada Prices Effective May 1, 2021



Options	Description	Price
10	SARGENT Signature System	\$63.00 / cyl.
11	SARGENT XC Key System (not available w/10, 22, KESO, SC, & SE options)	No addition
1160	SARGENT XC Large Format Interchangeable Plastic Disposable Construction Core	No addition
1163	SARGENT XC Large Format Interchangeable Core Cylinder – Includes masterkeying charges	\$83.00
1164	SARGENT XC Large Format Interchangeable Construction Core Cylinder	\$83.00
1170	Small Format interchangeable disposable construction core - to accept 7 Pin XC permanent core	No addition
11727P	Small Format interchangeable keyed construction core - to accept 7 Pin XC permanent core	\$75.00
11737P	Small Format interchangeable core - to accept 7 pin XC permanent core	\$75.00 / cyl.
16	Cylinder lockdown feature in rail (not available with 57-, 59-, AL- options)	\$133.00
19	80 Series pushbar without Lexan touchpad	No addition
21	SARGENT Construction Key System (lost ball)	\$16.00 / cyl.
22	SARGENT Construction Key System (split key)	\$32.00 / cyl.
31	For doors greater than 1-3/4" and up to 2-1/4" (including those with auxiliary controls)	No addition
	For doors over 2-1/4"	Consult Factory
	For doors with panels (See catalog for ordering details)	No addition
36	6 Lobe security head screws	\$64.00
37	Spanner head screws	\$46.00
43	Flush End Cap	No addition
5CH	5lb. Pressure Release	\$64.00
* 53	Latchbolt Monitor Switch – available with 55, 56, 57, 58, AL options)	\$256.00
54	Internal Micro Switch in ET Control	\$232.00
* 55	Signal Switch in Rail	\$241.00
* 56	Remote Dogging / Latch Retraction (Minimum door width for narrow stile is 26" and wide stile is 28")	\$852.00
* HK56	Latch Retraction with Hex Key Dogging	\$852.00
* 57	Delayed Action (Magnet ordered separate)	\$1,407.00
* 58	Electric Dogging	\$487.00
* 59	Electroguard (Not available with HC, 16, 53, 55, 56, 57, 58, NB options)	\$1,723.00
* BC59	Electroguard Boca Code (Needs Door Status Switch) (Not available with HC, 16, 53, 55, 56, 57, 58, NB options)	\$1,829.00
60	SARGENT Large Format Interchangeable Plastic Disposable Construction Core	No addition
63	SARGENT Large Format Interchangeable Core Cylinder includes master and grandmaster keying charge	\$83.00 / cyl.
64	SARGENT Large Format Interchangeable Construction Core Cylinder	\$83.00
6573	Small Format 6 Pin Uncombined Core	\$65.00 / cyl.
65737P	Small Format 7 Pin Uncombined Core	\$65.00 / cyl.
70	Small Format Interchangeable Disposable plastic construction core	No addition
72	Small Format Interchangeable 6-Pin Construction Core (7-pin with 11 option)	\$75.00
73	Small Format 6-pin interchangeable core	\$75.00 / cyl.
737P	Small Format 7-pin interchangeable core	\$75.00 / cyl.
76	Tactile Warning - Milled Outside Lever (Not available with Studio, Coastal and the A Levers)	\$77.00
81	Cylinder to accept Keso (83) and Keso F1 (F183) removable core – no core provided	No addition
F182	SARGENT Keso Security, patent pending, cylinder – new key systems	\$91.00 / cyl.
F183	SARGENT Keso Security, patent pending, removable core cylinder – new key systems	\$130.00 / cyl.
82	SARGENT Keso Security Cylinder (existing key systems only)	\$91.00 / cyl.
83	SARGENT Keso Security Removable Core Cylinder (existing key systems only)	\$130.00 / cyl.
84	SARGENT Keso Security Removable Construction Core Cylinder	See CK-18
85	Tactile Warning - Abrasive Strip Inside Push Rail	\$101.00
86	Tactile Warning - Abrasive Coating Outside Lever	\$47.00
87	Tactile Warning - Abrasive Strip on Inside Push Rail & Coating on Outside Lever	\$148.00
* AL	Alarmed (not available with HC, HC4, 16-, 56- thru 59- options) (minimum Dr width 36")	\$595.00
BR	SARGENT Bump Resistant Cylinders (N/A w/10, 22, 30, 60, 63, 64, 70, 72, 73, 737P, KESO, SC, SE)	\$25.00 / cyl.
CPC	Clear Powder Coat – Recommended for exit devices used in full exterior application and highly corrosive areas with 32 and 32D finishes.	\$232.00
DG1	Patented Degree DG1 Key System	No addition
DG160	Hardware prepared for DG1-6300 Lg. Format IC cores, supplied with temporary plastic construction cores	No addition
DG163	Patented Degree DG1 Large Format Interchangeable Core Cylinder - Includes master keying charges	\$83.00
DG164	Hardware prepared for DG1-6300 Lg. Format IC cores, supplied with temporary keyed construction cores	\$83.00
DG2	Patented Degree DG2 Key System incorporating a locking sidebar	\$63.00/cyl.
DG260	Hardware prepared for DG2-6300 Lg. Format IC cores, supplied with temporary plastic construction cores	No addition
DG263	Patented Degree DG2 Large Format Interchangeable Core Cylinder - Includes master keying charges	\$146.00
DG264	Hardware prepared for DG2-6300 Lg. Format IC cores, supplied with temporary keyed construction cores	\$83.00
DG3	Patented Degree DG3 Key System incorporating a locking sidebar and UL437 listed	\$89.00/cyl.
DG360	Hardware prepared for DG3-6300 Lg. Format IC cores, supplied with temporary plastic construction cores	No addition
DG363	Patented Degree DG3 Large Format Interchangeable Core Cylinder - Includes master keying charges	\$172.00
DG364	Hardware prepared for DG3-6300 Lg. Format IC cores, supplied with temporary keyed construction cores	\$83.00
LC	Less Cylinder	-\$96.00/cyl.
LD	Less Dogging	No addition
* PL	SARGuide™ PL – Photoluminescent Coating – (Pushbar w/o Lexan Touchpad - 19 option is supplied as standard)	\$376.00
NB	No Bottom Rod (Not available with 59 and BC59 option)	No addition
SC	Schlage C Keyway Cylinder 0-Bitted (Rim and #41 Mortise Cylinder Only)	No addition
SE	Schlage E Keyway Cylinder 0-Bitted (Rim and #41 Mortise Cylinder Only)	No addition
SG	MicroShield® an antimicrobial powder coat (not available with 10B)	\$88.00
* TL	SARGuide™ – Illuminated Touchpad (not available with AL, 57, 59 options)	\$232.00

*** Exact door width required when ordering.**

Vertical Rod Device to 96" Height	No addition
Concealed/Surface Vertical Rod Device over 96" to 120" Height	\$64.00
Refer to catalog for max. door height availability on fire rated exit devices.	

USA & Canada Prices Effective May 1, 2021



8400 Series-Narrow Stile Concealed Vertical Rod			
 ET Control	 ET Control		
Standard Levers: A-B-E-F-J-L-P-W Coastal Levers: G-R-S-Y All Studio Collection Levers (Except Gramercy, Wooster Square, & Grant Park)	Gramercy Series: RAG-RAL-RAM-RAS-RCM-REM-RGM Wooster Square: H001-H002-H003-H004-H005-H006 Grant Park: H007-H008-H009-H010-H011	Auxiliary Control (106/113)	with 862, 863, 864 Pull Price includes 862 Pull (shown)
Finishes listed below are for the exit device. Refer to catalog for available trims, trim finishes and how to order.			

8400 Series			Finish					
Option	Function	Description	10BE/32D/ BSP/WSP	03/04/09/10/10B/ 10BL/20D/32	10BE/32D/ BSP/WSP	03/04/09/10/10B/ 10BL/20D/32	10BE/32D BSP/WSP	03/04/10/ 10B/ 32
AD	8410	Exit Only No Trim	\$3,060.00	\$3,216.00				
AD	8410	Dummy Trim (Lever rigid)	\$3,820.00	\$3,976.00	\$4,063.00	\$4,219.00	\$3,354.00	\$3,533.00
AD	8410*	Key operates control					\$4,114.00	\$4,293.00
AD	8406	Key operates ET						
AD	8413	Key locks/unlocks ET	\$3,820.00	\$3,976.00	\$4,063.00	\$4,219.00		
AD	8415	Trim always operable						
*When ordering Exits with Auxiliary Control, please order as follows: example: 8410F x 106/113 x 862 x 32D x RHR								
8400 Series With Freewheeling Trim								
AD	8440	Dummy Trim (Lever rotates)						
AD	8443	Key engages/disengages lever	\$3,820.00	\$3,976.00	\$4,063.00	\$4,219.00		
AD	8446	Key operates control						
8400 Series With Electro-Mechanical								
AD	8473	Fail Safe 12v or 24v	\$4,132.00	\$4,288.00	\$4,325.00	\$4,481.00		
AD	8474	Fail Secure 12v or 24v						
Note: Specify voltage required when ordering.								
863 (18" x 1" Diameter) Pull provided in lieu of 862 (10" x 1" Diameter)								Add \$72.00
864 (10" x 3/4" Diameter) Pull provided in lieu of 862 (10" x 1" Diameter)								Deduct \$37.00

NOTES:

▶ Dummy Trim includes pull only, auxiliary control not supplied.

Thru Bolt application not available.

Cylinders not included when ordered less trim.

15 or 26D finishes are available on outside trim only, the exit devices will be supplied in 32D.

14 or 26 Finishes are available on outside trim only, the exit devices will be supplied in 32 finish.

ED-12 EXIT DEVICES

SARGENT®

ASSA ABLOY

MD8400 SERIES OPTIONS

USA & Canada Prices Effective May 1, 2021

Options	Description	Price
10	SARGENT Signature System	\$63.00 / cyl.
11	SARGENT XC Key System (not available w/10, 22, KESO, SC, & SE options)	No addition
12	UL Fire Label Exit Devices (not available with 16- & HK options)	\$184.00
1160	SARGENT XC Large Format Interchangeable Plastic Disposable Construction Core	No addition
1163	SARGENT XC Large Format Interchangeable Core Cylinder – Includes masterkeying charges	\$83.00
1164	SARGENT XC Large Format Interchangeable Construction Core Cylinder	\$83.00
1170	Small Format interchangeable disposable construction core - to accept 7 Pin XC permanent core	No addition
11727P	Small Format interchangeable keyed construction core - to accept 7 Pin XC permanent core	\$75.00
11737P	Small Format interchangeable core - to accept 7 pin XC permanent core	\$75.00 / cyl.
16	Cylinder lockdown feature in rail (not available with 12-, 57-, 59-, AL- options)	\$133.00
19	80 Series pushbar without Lexan touchpad	No addition
21	SARGENT Construction Key System (lost ball)	\$16.00 / cyl.
22	SARGENT Construction Key System (split key)	\$32.00 / cyl.
31	For doors greater than 1-3/4" and up to 2-1/4" (including those with auxiliary controls)	No addition
	For doors over 2-1/4"	Consult Factory
	For doors with panels (See catalog for ordering details)	No addition
36	6 Lobe security head screws	\$64.00
37	Spanner head screws	\$46.00
43	Flush End Cap	No addition
5CH	5lb. Pressure Release	\$64.00
* 53	Latchbolt Monitor Switch – available with 55, 56, 57, 58, AL options	\$256.00
54	Internal Micro Switch in ET Control	\$232.00
* 55	Signal Switch in Rail	\$241.00
* 56	Remote Dogging / Latch Retraction (Minimum door width for narrow stile is 26" and wide stile is 28")	\$852.00
* HK56	Latch Retraction with Hex Key Dogging	\$852.00
* 57	Delayed Action (Magnet ordered separate)	\$1,407.00
* 58	Electric Dogging	\$487.00
* 59	Electroguard (Not available with HC, 16, 53, 55, 56, 57, 58, NB options)	\$1,723.00
* BC59	Electroguard Boca Code (Needs Door Status Switch) (Not available with HC, 16, 53, 55, 56, 57, 58, NB options)	\$1,829.00
60	SARGENT Large Format Interchangeable Plastic Disposable Construction Core	No addition
63	SARGENT Large Format Interchangeable Core Cylinder includes master and grandmaster keying charge	\$83.00 / cyl.
64	SARGENT Large Format Interchangeable Construction Core Cylinder	\$83.00
6573	Small Format 6 Pin Uncombined Core	\$65.00 / cyl.
65737P	Small Format 7 Pin Uncombined Core	\$65.00 / cyl.
70	Small Format Interchangeable Disposable plastic construction core	No addition
72	Small Format Interchangeable 6-Pin Construction Core (7-pin with 11 option)	\$75.00
73	Small Format 6-pin interchangeable core	\$75.00 / cyl.
737P	Small Format 7-pin interchangeable core	\$75.00 / cyl.
76	Tactile Warning - Milled Outside Lever (Not available with Studio, Coastal and the A Levers)	\$77.00
81	Cylinder to accept Keso (83) and Keso F1 (F183) removable core – no core provided	No addition
F182	SARGENT Keso Security, patent pending, cylinder – new key systems	\$91.00 / cyl.
F183	SARGENT Keso Security, patent pending, removable core cylinder – new key systems	\$130.00 / cyl.
82	SARGENT Keso Security Cylinder (existing key systems only)	\$91.00 / cyl.
83	SARGENT Keso Security Removable Core Cylinder (existing key systems only)	\$130.00 / cyl.
84	SARGENT Keso Security Removable Construction Core Cylinder	See CK-18
85	Tactile Warning - Abrasive Strip Inside Push Rail	\$101.00
86	Tactile Warning - Abrasive Coating Outside Lever	\$47.00
87	Tactile Warning - Abrasive Strip on Inside Push Rail & Coating on Outside Lever	\$148.00
* AL	Alarmed (not available with HC, HC4, 16-, 56- thru 59- options) (minimum Dr width 36")	\$595.00
BR	SARGENT Bump Resistant Cylinders (N/A w/10, 22, 30, 60, 63, 64, 70, 72, 73, 737P, KESO, SC, SE)	\$25.00 /cyl.
CPC	Clear Powder Coat – Recommended for exit devices used in full exterior application and highly corrosive areas with 32 and 32D finishes.	\$232.00
DG1	Patented Degree DG1 Key System	No addition
DG160	Hardware prepared for DG1-6300 Lg. Format IC cores, supplied with temporary plastic construction cores	No addition
DG163	Patented Degree DG1 Large Format Interchangeable Core Cylinder - Includes master keying charges	\$83.00
DG164	Hardware prepared for DG1-6300 Lg. Format IC cores, supplied with temporary keyed construction cores	\$83.00
DG2	Patented Degree DG2 Key System incorporating a locking sidebar	\$63.00/cyl.
DG260	Hardware prepared for DG2-6300 Lg. Format IC cores, supplied with temporary plastic construction cores	No addition
DG263	Patented Degree DG2 Large Format Interchangeable Core Cylinder - Includes master keying charges	\$146.00
DG264	Hardware prepared for DG2-6300 Lg. Format IC cores, supplied with temporary keyed construction cores	\$83.00
DG3	Patented Degree DG3 Key System incorporating a locking sidebar and UL437 listed	\$89.00/cyl.
DG360	Hardware prepared for DG3-6300 Lg. Format IC cores, supplied with temporary plastic construction cores	No addition
DG363	Patented Degree DG3 Large Format Interchangeable Core Cylinder - Includes master keying charges	\$172.00
DG364	Hardware prepared for DG3-6300 Lg. Format IC cores, supplied with temporary keyed construction cores	\$83.00
LC	Less Cylinder	-\$96.00/cyl.
LD	Less Dogging	No addition
NB	No Bottom Rod (Not available with 59 and BC59 option)	No addition
* PL	SARGuide™ PL – Photoluminescent Coating – (Pushbar w/o Lexan Touchpad - 19 option is supplied as standard)	\$376.00
SC	Schlage C Keyway Cylinder 0-Bitted (Rim and #41 Mortise Cylinder Only)	No addition
SE	Schlage E Keyway Cylinder 0-Bitted (Rim and #41 Mortise Cylinder Only)	No addition
SG	MicroShield® an antimicrobial powder coat (not available with 10B)	\$88.00
* TL	SARGuide™ – Illuminated Touchpad (not available with AL, 57, 59 options)	\$232.00

*** Exact door width required when ordering.**

Vertical Rod Device to 96" Height	No addition
Concealed/Surface Vertical Rod Device over 96" to 120" Height	\$64.00

Refer to catalog for max. door height availability on fire rated exit devices.



683 Thermal Pin Kit for use with 45/60/90 Minute Wood Doors	\$105.00
---	----------

Experience a safer
and more open world

Copyright © 2002-2021 Sargent Manufacturing Company, an ASSA ABLOY Group company. All rights reserved.
Reproduction in whole or in part without the express written permission of Sargent Manufacturing Company is prohibited.
Contact us at: 800-727-5477 or visit www.sargentlock.com. In Canada contact us at: 800-461-3007 or visit www.assaabloydss.ca

USA & Canada Prices Effective May 1, 2021



MD8400 Series-Narrow Stile Concealed Vertical Rod		
 ET Control	 ET Control	
Standard Levers: A-B-E-F-J-L-P-W Coastal Levers: G-R-S-Y All Studio Collection Levers (Except Gramercy, Wooster Square, & Grant Park)	Gramercy Series: RAG-RAL-RAM-RAS- RCM-REM-RGM Wooster Square: H001-H002-H003-H004- H005-H006 Grant Park: H007-H008-H009-H010-H011	Auxiliary Control (106/113) with 862, 863, 864 Pull Price includes 862 Pull (shown)
Finishes listed below are for the exit device. Refer to catalog for available trims, trim finishes and how to order.		

MD8400 Series			Finish					
Option	Function	Description	10BE/32D/ BSP/WSP	03/04/09/10/10B/ 10BL/20D/32	10BE/32D/ BSP/WSP	03/04/09/10/10B/ 10BL/20D/32	10BE/32D/ BSP/WSP	03/04/10/ 10B/32
MD	8410	Exit Only No Trim	\$3,060.00	\$3,216.00				
MD	8410	Dummy Trim (Lever rigid)	\$3,820.00	\$3,976.00	\$4,063.00	\$4,219.00	\$3,354.00	\$3,533.00
MD	8410*	Key operates control					\$4,114.00	\$4,293.00
MD	8406	Key operates ET						
MD	8413	Key locks/unlocks ET	\$3,820.00	\$3,976.00	\$4,063.00	\$4,219.00		
MD	8415	Trim always operable						
*When ordering Exits with Auxiliary Control Design, please order as follows: example: 12-MD8410F x 106/113 x 862 x 32D x RHR								
MD8400 With Freewheeling Trim								
MD	8440	Dummy Trim (Lever rotates)						
MD	8443	Key engages/disengages lever	\$3,820.00	\$3,976.00	\$4,063.00	\$4,219.00		
MD	8446	Key operates control						
MD8400 With Electro-Mechanical								
MD	8473	Fail Safe 12v or 24v						
MD	8474	Fail Secure 12v or 24v	\$4,132.00	\$4,288.00	\$4,325.00	\$4,481.00		
Note: Specify voltage required when ordering.								
863 (18" x 1" Diameter) Pull provided in lieu of 862 (10" x 1" Diameter)								Add \$72.00
864 (10" x 3/4" Diameter) Pull provided in lieu of 862 (10" x 1" Diameter)								Deduct \$37.00

NOTES:

- ▶ Dummy Trim includes pull only, auxiliary control not supplied.
- Thru Bolt application not available.
- Cylinders not included when ordered less trim.

15 or 26D finishes are available on outside trim only, the exit devices will be supplied in 32D.
14 or 26 Finishes are available on outside trim only, the exit devices will be supplied in 32 finish.

AD8500 SERIES OPTIONS



USA & Canada Prices Effective May 1, 2021

Options	Description	Price
10	SARGENT Signature System	\$63.00 / cyl.
11	SARGENT XC Key System (not available w/10, 22, KESO, SC, & SE options)	No addition
1160	SARGENT XC Large Format Interchangeable Plastic Disposable Construction Core	No addition
1163	SARGENT XC Large Format Interchangeable Core Cylinder – Includes masterkeying charges	\$83.00
1164	SARGENT XC Large Format Interchangeable Construction Core Cylinder	\$83.00
1170	Small Format interchangeable disposable construction core - to accept 7 Pin XC permanent core	No addition
11727P	Small Format interchangeable keyed construction core - to accept 7 Pin XC permanent core	\$75.00
11737P	Small Format interchangeable core - to accept 7 pin XC permanent core	\$75.00 / cyl.
12	UL Fire Label Exit Devices (not available with 16- option)	\$184.00
16	Cylinder lockdown feature in rail (not available with 57-, 59-, AL- options)	\$133.00
19	80 Series pushbar without Lexan touchpad	No addition
21	SARGENT Construction Key System (lost ball)	\$16.00 cyl.
22	SARGENT Construction Key System (split key)	\$32.00 / cyl.
31	For doors greater than 1-3/4" and up to 2-1/4" (including those with auxiliary controls) For doors over 2-1/4" For doors with panels (See catalog for ordering details)	No addition Consult Factory No addition
36	6 Lobe security head screws	\$38.00
37	Spanner head screws	\$27.00
43	Flush End Cap	No addition
5CH	5lb. Pressure Release	\$30.00
* 53	Latchbolt Monitor Switch – available with 55, 56, 57, 58, AL option	\$256.00
* 54	Internal Micro Switch in ET Control	\$232.00
* 55	Signal Switch in Rail	\$241.00
* 56	Remote Dogging / Latch Retraction (Minimum door width for narrow stile is 26" and wide stile is 28")	\$852.00
* HK56	Latch Retraction with Hex Key Dogging	\$852.00
* 57	Delayed Action (Magnet ordered separate)	\$1,407.00
* 58	Electric Dogging	\$487.00
59	Electroguard (Not available with 16, 53, 55 56, 57, 58, NB prefixes)	\$1,723.00
* BC59	Electroguard Boca Code (Needs Door Status Switch) (Not available with 16, 53, 55 56, 57, 58, NB prefixes)	\$1,829.00
60	SARGENT Large Format Interchangeable Plastic Disposable Construction Core	No addition
63	SARGENT Large Format Interchangeable Core Cylinder includes master and grandmaster keying charge	\$83.00 /cyl.
64	SARGENT Large Format Interchangeable Construction Core Cylinder	\$83.00
6573	Small Format 6 Pin Uncombined Core	\$65.00 / cyl.
65737P	Small Format 7 Pin Uncombined Core	\$65.00 / cyl.
70	Small Format Interchangeable Disposable plastic construction core	No addition
72	Small Format Interchangeable 6-Pin Construction Core (7-pin with 11 option)	\$75.00
73	Small Format 6-pin interchangeable core	\$75.00 / cyl.
737P	Small Format 7-pin interchangeable core	\$75.00 / cyl.
76	Tactile Warning - Milled Outside Lever (Not available with Studio, Coastal and the A Levers)	\$77.00
81	Cylinder to accept Keso (83) and Keso F1 (F183) removable core – no core provided	No addition
F182	SARGENT Keso Security, patent pending, cylinder – new key systems	\$91.00 / cyl.
F183	SARGENT Keso Security, patent pending, removable core cylinder – new key systems	\$130.00 / cyl.
82	SARGENT Keso Security Cylinder (existing key systems only)	\$91.00 / cyl.
83	SARGENT Keso Security Removable Core Cylinder (existing key systems only)	\$130.00 / cyl.
84	SARGENT Keso Security Removable Construction Core Cylinder	See CK-18
85	Tactile Warning - Abrasive Strip Inside Push Rail	\$101.00
86	Tactile Warning - Abrasive Coating Outside Lever	\$47.00
87	Tactile Warning - Abrasive Strip on Inside Push Rail & Coating on Outside Lever	\$148.00
* AL	Alarmed (not available with HC, HC4, 16-, 56- thru 59- options) (minimum Dr width 36")	\$595.00
BR	SARGENT Bump Resistant Cylinders (N/A w/10, 22, 30, 60, 63, 64, 70, 72, 73, 737P, KESO, SC, SE)	\$25.00 /cyl.
CPC	Clear Powder Coat – Recommended for exit devices used in full exterior application and highly corrosive areas with 32 and 32D finishes.	\$232.00
DG1	Patented Degree DG1 Key System	No addition
DG160	Hardware prepared for DG1-6300 Lg. Format IC cores, supplied with temporary plastic construction cores	No addition
DG163	Patented Degree DG1 Large Format Interchangeable Core Cylinder - Includes master keying charges	\$83.00
DG164	Hardware prepared for DG1-6300 Lg. Format IC cores, supplied with temporary keyed construction cores	\$83.00
DG2	Patented Degree DG2 Key System incorporating a locking sidebar	\$63.00/cyl.
DG260	Hardware prepared for DG2-6300 Lg. Format IC cores, supplied with temporary plastic construction cores	No addition
DG263	Patented Degree DG2 Large Format Interchangeable Core Cylinder - Includes master keying charges	\$146.00
DG264	Hardware prepared for DG2-6300 Lg. Format IC cores, supplied with temporary keyed construction cores	\$83.00
DG3	Patented Degree DG3 Key System incorporating a locking sidebar and UL437 listed	\$89.00/cyl.
DG360	Hardware prepared for DG3-6300 Lg. Format IC cores, supplied with temporary plastic construction cores	No addition
DG363	Patented Degree DG3 Large Format Interchangeable Core Cylinder - Includes master keying charges	\$172.00
DG364	Hardware prepared for DG3-6300 Lg. Format IC cores, supplied with temporary keyed construction cores	\$83.00
GL	Guarded Latch	\$33.00
LC	Less Cylinder	-\$96.00/cyl.
LD	Less Dogging	No addition
PL	SARGuide™ PL – Photoluminescent Coating – (Pushbar w/o Lexan Touchpad - 19 option is supplied as standard)	\$376.00
SC	Schlage C Keyway Cylinder 0-Bitted (Rim and #41 Mortise Cylinder Only)	No addition
SE	Schlage E Keyway Cylinder 0-Bitted (Rim and #41 Mortise Cylinder Only)	No addition
SG	MicroShield® an antimicrobial powder coat option (not available with 10B)	\$88.00
TB	Thru Bolt	\$26.00
* TL	SARGuide™ – Illuminated Touchpad (not available with AL, 57, 59 options)	\$232.00
WS	Windstorm Certified (Rim & Mortise Exit Devices only)	No Addition

* Exact door width required when ordering.

USA & Canada Prices Effective May 1, 2021



AD8500 Series-Narrow Stile Rim Device		
 ET Control	 ET Control	 Cylinder included on keyed functions.
Standard Levers: A-B-E-F-J-L-P-W Coastal Levers: G-R-S-Y All Studio Collection Levers (Except Gramercy, Wooster Square, & Grant Park)	Gramercy Series: RAG-RAL-RAM-RAS-RCM-REM-RGM Wooster Square: H001-H002-H003-H004-H005-H006 Grant Park: H007-H008-H009-H010-H011	862, 863, 864 Pull Price includes 862 Pull (shown)
Finishes listed below are for the exit device. Refer to catalog for available trims, trim finishes and how to order.		

AD8500 Series			Finish					
Option	Function	Description	10BE/32D BSP/WSP	03/04/09/10/10B/ 10BL/20D/32	10BE/32D/ BSP/WSP	03/04/09/10/10B/ 10BL/20D/32	10BE/32D/ BSP/WSP	03/04/10/ 10B/32
AD	8510	Exit Only No Trim	\$2,251.00	\$2,351.00				
AD	8510	Dummy Trim (Lever rigid)					\$2,545.00	\$2,668.00
AD	8504	Key retracts latchbolt (Lever rigid)						
AD	8506	Key operates ET	\$3,011.00	\$3,111.00	\$3,254.00	\$3,354.00		
AD	8513	Key locks/unlocks control						
AD	8515	Trim always operable						
AD8500 Series With Freewheeling Trim								
AD	8540	Dummy Trim (Lever rotates)						
AD	8543	Key engages/disengages lever	\$3,011.00	\$3,111.00	\$3,254.00	\$3,354.00		
AD	8544	Key retracts latchbolt (Lever rotates)						
AD	8546	Key operates control						
AD8500 Series With Electro-Mechanical								
AD	8573	Fail Safe 12v or 24v	\$3,323.00	\$3,423.00	\$3,516.00	\$3,616.00		
AD	8574	Fail Secure 12v or 24v						

Note: Specify voltage required when ordering.

863 (18" x 1" Diameter) Pull provided in lieu of 862 (10" x 1" Diameter) Add \$72.00

864 (10" x 3/4" Diameter) Pull provided in lieu of 862 (10" x 1" Diameter) Deduct \$37.00

Thru Bolt Application	Pack Part #		Finish	
No. Bolts per Pack	1-3/4" Dr.	2-1/4" Dr.	03/04/09/10/10B/10BL/20D/26D/BSP/WSP	
8500	4	68-2510	68-2511	\$25.00 Pack

NOTES: Cylinder not included when ordered less trim except for 04 function.

15 or 26D finishes are available on outside trim only, the exit devices will be supplied in 32D.

14 or 26 Finishes are available on outside trim only, the exit devices will be supplied in 32 finish.

ED-16 EXIT DEVICES

SARGENT®

ASSA ABLOY

8500 SERIES OPTIONS

USA & Canada Prices Effective May 1, 2021

Options	Description	Price
10	SARGENT Signature System	\$63.00 / cyl.
11	SARGENT XC Key System (not available w/10, 22, KESO, SC, & SE options)	No addition
1160	SARGENT XC Large Format Interchangeable Plastic Disposable Construction Core	No addition
1163	SARGENT XC Large Format Interchangeable Core Cylinder – Includes masterkeying charges	\$83.00
1164	SARGENT XC Large Format Interchangeable Construction Core Cylinder	\$83.00
1170	Small Format interchangeable disposable construction core - to accept 7 Pin XC permanent core	No addition
11727P	Small Format interchangeable keyed construction core - to accept 7 Pin XC permanent core	\$75.00
11737P	Small Format interchangeable core - to accept 7 pin XC permanent core	\$75.00 / cyl.
12	UL Fire Label Exit Devices (not available with 16- option)	\$184.00
16	Cylinder lockdown feature in rail (not available with 57-, 59-, AL- options)	\$133.00
19	80 Series pushbar without Lexan touchpad	No addition
21	SARGENT Construction Key System (lost ball)	\$16.00 cyl.
22	SARGENT Construction Key System (split key)	\$32.00 / cyl.
31	For doors greater than 1-3/4" and up to 2-1/4" (including those with auxiliary controls)	No addition
	For doors over 2-1/4"	Consult Factory
	For doors with panels (See catalog for ordering details)	No addition
36	6 Lobe security head screws	\$38.00
37	Spanner head screws	\$27.00
43	Flush End Cap	No addition
5CH	5lb. Pressure Release	\$30.00
* 53	Latchbolt Monitor Switch – available with 55, 56, 57, 58, AL option	\$256.00
* 54	Internal Micro Switch in ET Control	\$232.00
* 55	Signal Switch in Rail	\$241.00
* 56	Remote Dogging / Latch Retraction (Minimum door width for narrow stile is 26" and wide stile is 28")	\$852.00
* HK56	Latch Retraction with Hex Key Dogging	\$852.00
* 57	Delayed Action (Magnet ordered separate)	\$1,407.00
* 58	Electric Dogging	\$487.00
* 59	Electroguard (Not available with HC-, 16-, 53-, 55-, 56-, 57-, 58- Options)	\$1,723.00
* BC59	Electroguard Boca Code (Needs Door Status Switch) (Not available with HC-, 16-, 53-, 55-, 56-, 57-, 58- Options)	\$1,829.00
60	SARGENT Large Format Interchangeable Plastic Disposable Construction Core	No addition
63	SARGENT Large Format Interchangeable Core Cylinder includes master and grandmaster keying charge	\$83.00 /cyl.
64	SARGENT Large Format Interchangeable Construction Core Cylinder	\$83.00
6573	Small Format 6 Pin Uncombined Core	\$65.00 / cyl.
65737P	Small Format 7 Pin Uncombined Core	\$65.00 / cyl.
70	Small Format interchangeable Disposable plastic construction core	No addition
72	Small Format interchangeable 6-Pin Construction Core (7-pin with 11 option)	\$75.00
73	Small Format 6-pin interchangeable core	\$75.00 / cyl.
737P	Small Format 7-pin interchangeable core	\$75.00 / cyl.
76	Tactile Warning - Milled Outside Lever (Not available with Studio, Coastal and the A Levers)	\$77.00
81	Cylinder to accept Keso (83) and Keso F1 (F183) removable core – no core provided	No addition
F182	SARGENT Keso Security, patent pending, cylinder – new key systems	\$91.00 / cyl.
F183	SARGENT Keso Security, patent pending, removable core cylinder – new key systems	\$130.00 / cyl.
82	SARGENT Keso Security Cylinder (existing key systems only)	\$91.00 / cyl.
83	SARGENT Keso Security Removable Core Cylinder (existing key systems only)	\$130.00 / cyl.
84	SARGENT Keso Security Removable Construction Core Cylinder	See CK-18
85	Tactile Warning - Abrasive Strip Inside Push Rail	\$101.00
86	Tactile Warning - Abrasive Coating Outside Lever	\$47.00
87	Tactile Warning - Abrasive Strip on Inside Push Rail & Coating on Outside Lever	\$148.00
* AL	Alarmed (not available with HC, HC4, 16-, 56- thru 59- options) (minimum Dr width 36")	\$595.00
BR	SARGENT Bump Resistant Cylinders (N/A w/10, 22, 30, 60, 63, 64, 70, 72, 73, 737P, KESO, SC, SE)	\$25.00 /cyl.
CPC	Clear Powder Coat – Recommended for exit devices used in full exterior application and highly corrosive areas with 32 and 32D finishes.	\$232.00
DG1	Patented Degree DG1 Key System	No addition
DG160	Hardware prepared for DG1-6300 Lg. Format IC cores, supplied with temporary plastic construction cores	No addition
DG163	Patented Degree DG1 Large Format Interchangeable Core Cylinder - Includes master keying charges	\$83.00
DG164	Hardware prepared for DG1-6300 Lg. Format IC cores, supplied with temporary keyed construction cores	\$83.00
DG2	Patented Degree DG2 Key System incorporating a locking sidebar	\$63.00/cyl.
DG260	Hardware prepared for DG2-6300 Lg. Format IC cores, supplied with temporary plastic construction cores	No addition
DG263	Patented Degree DG2 Large Format Interchangeable Core Cylinder - Includes master keying charges	\$146.00
DG264	Hardware prepared for DG2-6300 Lg. Format IC cores, supplied with temporary keyed construction cores	\$83.00
DG3	Patented Degree DG3 Key System incorporating a locking sidebar and UL437 listed	\$89.00/cyl.
DG360	Hardware prepared for DG3-6300 Lg. Format IC cores, supplied with temporary plastic construction cores	No addition
DG363	Patented Degree DG3 Large Format Interchangeable Core Cylinder - Includes master keying charges	\$172.00
DG364	Hardware prepared for DG3-6300 Lg. Format IC cores, supplied with temporary keyed construction cores	\$83.00
GL	Guarded Latch	\$33.00
LC	Less Cylinder	-\$96.00/cyl.
LD	Less Dogging	No addition
PL	SARGuide™ PL – Photoluminescent Coating – (Pushbar w/o Lexan Touchpad - 19 option is supplied as standard)	\$376.00
SC	Schlage C Keyway Cylinder 0-Bitted (Rim and #41 Mortise Cylinder Only)	No addition
SE	Schlage E Keyway Cylinder 0-Bitted (Rim and #41 Mortise Cylinder Only)	No addition
SG	MicroShield® an antimicrobial powder coat option (not available with 10B)	\$88.00
TB	Thru Bolt	\$26.00
* TL	SARGuide™ – Illuminated Touchpad (not available with AL, 57, 59 options)	\$232.00



* Exact door width required when ordering.

Experience a safer
and more open world

Copyright © 2002-2021 Sargent Manufacturing Company, an ASSA ABLOY Group company. All rights reserved.
Reproduction in whole or in part without the express written permission of Sargent Manufacturing Company is prohibited.
Contact us at: 800-727-5477 or visit www.sargentlock.com. In Canada contact us at: 800-461-3007 or visit www.assaabloydss.ca

USA & Canada Prices Effective May 1, 2021



8500 Series-Narrow Stile Rim Device		
 ET Control	 ET Control	 Cylinder included on keyed functions.
Standard Levers: A-B-E-F-J-L-P-W Coastal Levers: G-R-S-Y All Studio Collection Levers (Except Gramercy, Wooster Square, & Grant Park)	Gramercy Series: RAG-RAL-RAM-RAS-RCM-REM-RGM Wooster Square: H001-H002-H003-H004-H005-H006 Grant Park: H007-H008-H009-H010-H011	862, 863, 864 Pull Price includes 862 Pull (shown)
Finishes listed below are for the exit device. Refer to catalog for available trims, trim finishes and how to order.		

8500 Series		Finish					
		10BE/32D/	03/04/09/10/10B/	10BE/32D/	03/04/09/10/10B/	10BE/32D/	03/04/10/
Function Description		BSP/WSP	10BL/20D/32	BSP/WSP	10BL/20D/32	BSP/WSP	10B/32
8510	Exit Only No Trim	\$2,251.00	\$2,351.00				
8510	Dummy Trim (Lever rigid)					\$2,545.00	\$2,668.00
8504	Key retracts latchbolt (Lever rigid)						
8506	Key operates ET	\$3,011.00	\$3,111.00	\$3,254.00	\$3,354.00		
8513	Key locks/unlocks control						
8515	Trim always operable						
8500 Series With Freewheeling Trim							
8540	Dummy Trim (Lever rotates)						
8543	Key engages/disengages lever						
8544	Key retracts latchbolt (Lever rotates)	\$3,011.00	\$3,111.00	\$3,254.00	\$3,354.00		
8546	Key operates control						
8500 Series With Electro-Mechanical							
8573	Fail Safe 12v or 24v						
8574	Fail Secure 12v or 24v	\$3,323.00	\$3,423.00	\$3,516.00	\$3,616.00		

Note: Specify voltage required when ordering.

863 (18" x 1" Diameter) Pull provided in lieu of 862 (10" x 1" Diameter) Add \$72.00

864 (10" x 3/4" Diameter) Pull provided in lieu of 862 (10" x 1" Diameter) Deduct \$37.00

Thru Bolt Application	Pack Part #		Finish	
	No. Bolts per Pack	1-3/4" Dr.	2-1/4" Dr.	03/04/09/10/10B/10BE/10BL/20D/26D/BSP/WSP
8500	4	68-2510	68-2511	\$25.00 Pack

NOTES: Cylinder not included when ordered less trim except for 04 function.

15 or 26D finishes are available on outside trim only, the exit devices will be supplied in 32D.

14 or 26 Finishes are available on outside trim only, the exit devices will be supplied in 32 finish.

AD8600 SERIES OPTIONS

USA & Canada Prices Effective May 1, 2021



Options	Description	Price
10	SARGENT Signature System	\$63.00 / cyl.
11	SARGENT XC Key System (not available w/10, 22, KESO, SC, & SE options)	No addition
1160	SARGENT XC Large Format Interchangeable Plastic Disposable Construction Core	No addition
1163	SARGENT XC Large Format Interchangeable Core Cylinder – Includes masterkeying charges	\$83.00
1164	SARGENT XC Large Format Interchangeable Construction Core Cylinder	\$83.00
1170	Small Format interchangeable disposable construction core - to accept 7 Pin XC permanent core	No addition
11727P	Small Format interchangeable keyed construction core - to accept 7 Pin XC permanent core	\$75.00
11737P	Small Format interchangeable core - to accept 7 pin XC permanent core	\$75.00 / cyl.
16	Cylinder lockdown feature in rail (not available with 12-, 57-, 59-, AL- options)	\$133.00
19	80 Series pushbar without Lexan touchpad	No addition
21	SARGENT Construction Key System (lost ball)	\$16.00 /cyl.
22	SARGENT Construction Key System (split key)	\$32.00 /cyl.
31	For doors greater than 1-3/4" and up to 2-1/4" (including those with auxiliary controls)	No addition
	For doors over 2-1/4"	Consult Factory
	For doors with panels (See catalog for ordering details)	No addition
36	6 Lobe security head screws	\$64.00
37	Spanner head screws	\$46.00
43	Flush End Cap	No addition
5CH	5lb. Pressure Release	\$64.00
* 53	Latchbolt Monitor Switch – available with 55, 56, 57, 58, AL options	\$256.00
54	Internal Micro Switch in ET Control	\$232.00
* 55	Signal Switch in Rail	\$241.00
* 56	Remote Dogging / Latch Retraction (Minimum door width for narrow stile is 26" and wide stile is 28")	\$852.00
* HK56	Latch Retraction with Hex Key Dogging	\$852.00
* 57	Delayed Action (Magnet ordered separate)	\$1,407.00
* 58	Electric Dogging	\$487.00
* 59	Electroguard (Not available with HC, 16, 53, 55, 56, 57, 58, NB options)	\$1,723.00
* BC59	Electroguard Boca Code (Needs Door Status Switch) (Not available with HC, 16, 53, 55, 56, 57, 58, NB options)	\$1,829.00
60	SARGENT Large Format Interchangeable Plastic Disposable Construction Core	No addition
63	SARGENT Large Format Interchangeable Core Cylinder includes master and grandmaster keying charge	\$83.00 /cyl.
64	SARGENT Large Format Interchangeable Construction Core Cylinder	\$83.00
6573	Small Format 6 Pin Uncombined Core	\$65.00 / cyl.
65737P	Small Format 7 Pin Uncombined Core	\$65.00 / cyl.
70	Small Format Interchangeable Disposable plastic Construction Core	No addition
72	Small Format Interchangeable 6-Pin Construction Core (7-pin with 11 option)	\$75.00
73	Small Format 6-pin interchangeable core	\$75.00 / cyl.
73-7P	Small Format 7-pin interchangeable core	\$75.00 / cyl.
76	Tactile Warning - Milled Outside Lever (Not available with Studio, Coastal and the A Levers)	\$77.00
81	Cylinder to accept Keso (83) and Keso F1 (F183) removable core – no core provided	No addition
F182	SARGENT Keso Security, patent pending, cylinder – new key systems	\$91.00 / cyl.
F183	SARGENT Keso Security, patent pending, removable core cylinder – new key systems	\$130.00 / cyl.
82	SARGENT Keso Security Cylinder (existing key systems only)	\$91.00 / cyl.
83	SARGENT Keso Security Removable Core Cylinder (existing key systems only)	\$130.00 / cyl.
84	SARGENT Keso Security Removable Construction Core Cylinder	See CK-18
85	Tactile Warning - Abrasive Strip Inside Push Rail	\$101.00
86	Tactile Warning - Abrasive Coating Outside Lever	\$47.00
87	Tactile Warning - Abrasive Strip on Inside Push Rail & Coating on Outside Lever	\$148.00
* AL	Alarmed (not available with HC, HC4, 16-, 56- thru 59- options) (minimum Dr width 36")	\$595.00
BR	SARGENT Bump Resistant Cylinders (N/A w/10, 22, 30, 60, 63, 64, 70, 73, 737P, KESO, SC, SE)	\$25.00 /cyl.
CPC	Clear Powder Coat – Recommended for exit devices used in full exterior application and highly corrosive areas with 32 and 32D finishes.	\$232.00
DG1	Patented Degree DG1 Key System	No addition
DG160	Hardware prepared for DG1-6300 Lg. Format IC cores, supplied with temporary plastic construction cores	No addition
DG163	Patented Degree DG1 Large Format Interchangeable Core Cylinder - Includes master keying charges	\$83.00
DG164	Hardware prepared for DG1-6300 Lg. Format IC cores, supplied with temporary keyed construction cores	\$83.00
DG2	Patented Degree DG2 Key System incorporating a locking sidebar	\$63.00/cyl.
DG260	Hardware prepared for DG2-6300 Lg. Format IC cores, supplied with temporary plastic construction cores	No addition
DG263	Patented Degree DG2 Large Format Interchangeable Core Cylinder - Includes master keying charges	\$146.00
DG264	Hardware prepared for DG2-6300 Lg. Format IC cores, supplied with temporary keyed construction cores	\$83.00
DG3	Patented Degree DG3 Key System incorporating a locking sidebar and UL437 listed	\$89.00/cyl.
DG360	Hardware prepared for DG3-6300 Lg. Format IC cores, supplied with temporary plastic construction cores	No addition
DG363	Patented Degree DG3 Large Format Interchangeable Core Cylinder - Includes master keying charges	\$172.00
DG364	Hardware prepared for DG3-6300 Lg. Format IC cores, supplied with temporary keyed construction cores	\$83.00
LC	Less Cylinder	-\$96.00/cyl.
LD	Less Dogging	No addition
PL	SARGuide™ PL – Photoluminescent Coating – (Pushbar w/o Lexan Touchpad - 19 option is supplied as standard)	\$376.00
NB	No Bottom Rod (Not available with 59 and BC59 option)	No addition
SC	Schlage C Keyway Cylinder 0-Bitted (Rim and #41 Mortise Cylinder Only)	No addition
SE	Schlage E Keyway Cylinder 0-Bitted (Rim and #41 Mortise Cylinder Only)	No addition
SG	MicroShield® an antimicrobial powder coat (not available with 10B)	\$88.00
TB	Thru Bolt	\$26.00
* TL	SARGuide™ – Illuminated Touchpad (not available with AL, 57, 59 options)	\$232.00

*** Exact door width required when ordering.**
 Vertical Rod Device to 96" Height No addition
 Concealed/Surface Vertical Rod Device over 96" to 120" Height \$64.00
 Refer to catalog for max. door height availability on fire rated exit devices.

683 Thermal Pin Kit for use with 45/60/90 Minute Wood Doors
 683 \$105.00

USA & Canada Prices Effective May 1, 2021



AD8600 Series-Concealed Vertical Rod Device			
 ET Control	 ET Control		
Standard Levers: A-B-E-F-J-L-P-W Coastal Levers: G-R-S-Y All Studio Collection Levers (Except Gramercy, Wooster Square, & Grant Park)	Gramercy Series: RAG-RAL-RAM-RAS-RCM-REM-RGM Wooster Square: H001-H002-H003-H004-H005-H006 Grant Park: H007-H008-H009-H010-H011	Auxiliary Control (106/113)	with 862, 863, 864 Pull Price includes 862 Pull (shown)
Finishes listed below are for the exit device. Refer to catalog for available trims, trim finishes and how to order.			

AD8600 Series			Finish					
Option	Function	Description	10BE/32D BSP/WSP	03/04/09/10/10B/ 10BL/20D/32	10BE/32D/ BSP/WSP	03/04/09/10/10B/ 10BL/20D/32	10BE/32D/ BSP/WSP	03/04/10/ 10B/32
AD	8610	Exit Only No Trim	\$2,944.00	\$3,107.00				
AD	8610	Dummy Trim (Lever rigid)	\$3,704.00	\$3,867.00	\$3,947.00	\$4,110.00	\$3,238.00	\$3,424.00
AD	8610	Key operates control					\$3,998.00	\$4,184.00
AD	8606	Key operates ET						
AD	8613	Key locks/unlocks ET	\$3,704.00	\$3,867.00	\$3,947.00	\$4,110.00		
AD	8615	Trim always operable						

*When ordering Exits with Auxiliary Control Design, please order as follows: example: AD8610F x 106/113 x 862 x 32D x RHR

AD8600 With Freewheeling Trim								
AD	8640	Dummy Trim (Lever rotates)						
AD	8643	Key engages/disengages lever	\$3,704.00	\$3,867.00	\$3,947.00	\$4,110.00		
AD	8646	Key operates control						
AD8600 With Electro-Mechanical								
AD	8673	Fail Safe 12v or 24v						
AD	8674	Fail Secure 12v or 24v	\$4,016.00	\$4,179.00	\$4,209.00	\$4,372.00		

Note: Specify voltage required when ordering.

863 (18" x 1" Diameter) Pull provided in lieu of 862 (10" x 1" Diameter) Add \$72.00

864 (10" x 3/4" Diameter) Pull provided in lieu of 862 (10" x 1" Diameter) Deduct \$37.00

► Dummy Trim includes pull only, Auxiliary Control not supplied.

Thru Bolt Application		Pack Part #				Finish
	No. Bolts per Pack	1-3/4" Dr.	2-1/4" Dr.	03/04/09/10/10B/10BE/10BL/20D/26D/BSP/WSP		
AD	8600	4	68-2279	68-2280	\$25.00 Pack	

Note: Cylinders not included when ordered less trim.

15 or 26D finishes are available on outside trim only, the exit devices will be supplied in 32D.

14 or 26 Finishes are available on outside trim only, the exit devices will be supplied in 32 finish.

MD8600 SERIES OPTIONS

USA & Canada Prices Effective May 1, 2021

Options	Description	Price
10	SARGENT Signature System	\$63.00 / cyl.
11	SARGENT XC Key System (not available w/10, 22, KESO, SC, & SE options)	No addition
1160	SARGENT XC Large Format Interchangeable Plastic Disposable Construction Core	No addition
1163	SARGENT XC Large Format Interchangeable Core Cylinder – Includes masterkeying charges	\$83.00
1164	SARGENT XC Large Format Interchangeable Construction Core Cylinder	\$83.00
1170	Small Format interchangeable disposable construction core - to accept 7 Pin XC permanent core	No addition
11727P	Small Format interchangeable keyed construction core - to accept 7 Pin XC permanent core	\$75.00
11737P	Small Format interchangeable core - to accept 7 pin XC permanent core	\$75.00 / cyl.
12	UL Fire Label Exit Devices (not available with 16- & HK options)	\$184.00
16	Cylinder lockdown feature in rail (not available with 12-, 57-, 59-, AL- options)	\$133.00
19	80 Series pushbar without Lexan touchpad	No addition
21	SARGENT Construction Key System (lost ball)	\$16.00 /cyl.
22	SARGENT Construction Key System (split key)	\$32.00 /cyl.
31	For doors greater than 1-3/4" and up to 2-1/4" (including those with auxiliary controls)	No addition
	For doors over 2-1/4"	Consult Factory
	For doors with panels (See catalog for ordering details)	No addition
36	6 Lobe security head screws	\$64.00
37	Spanner head screws	\$46.00
43	Flush End Cap	No addition
5CH	5lb. Pressure Release	\$64.00
* 53	Latchbolt Monitor Switch – available with 55, 56, 57, 58, AL options	\$256.00
54	Internal Micro Switch in ET Control	\$232.00
* 55	Signal Switch in Rail	\$241.00
* 56	Remote Dogging / Latch Retraction (Minimum door width for narrow stile is 26" and wide stile is 28")	\$852.00
* HK56	Latch Retraction with Hex Key Dogging	\$852.00
* 57	Delayed Action (Magnet ordered separate)	\$1,407.00
* 58	Electric Dogging	\$487.00
* 59	Electroguard (Not available with 16, 53, 55, 56, 57, 58, NB options)	\$1,723.00
* BC59	Electroguard Boca Code (Needs Door Status Switch) (Not available with 16, 53, 55, 56, 57, 58, NB options)	\$1,829.00
60	SARGENT Large Format Interchangeable Plastic Disposable Construction Core	No addition
63	SARGENT Large Format Interchangeable Core Cylinder includes master and grandmaster keying charge	\$83.00 /cyl.
64	SARGENT Large Format Interchangeable Construction Core Cylinder	\$83.00
6573	Small Format 6 Pin Uncombined Core	\$65.00 / cyl.
65737P	Small Format 7 Pin Uncombined Core	\$65.00 / cyl.
70	Small Format Interchangeable Disposable plastic Construction Core	No addition
72	Small Format Interchangeable 6-Pin Construction Core (7-pin with 11 option)	\$75.00
73	Small Format 6-pin interchangeable core	\$75.00 / cyl.
73-7P	Small Format 7-pin interchangeable core	\$75.00 / cyl.
76	Tactile Warning - Milled Outside Lever (Not available with Studio, Coastal and the A Levers)	\$77.00
81	Cylinder to accept Keso (83) and Keso F1 (F183) removable core – no core provided	No addition
F182	SARGENT Keso Security, patent pending, cylinder – new key systems	\$91.00 / cyl.
F183	SARGENT Keso Security, patent pending, removable core cylinder – new key systems	\$130.00 / cyl.
82	SARGENT Keso Security Cylinder (existing key systems only)	\$91.00 / cyl.
83	SARGENT Keso Security Removable Core Cylinder (existing key systems only)	\$130.00 / cyl.
84	SARGENT Keso Security Removable Construction Core Cylinder	See CK-18
85	Tactile Warning - Abrasive Strip Inside Push Rail	\$101.00
86	Tactile Warning - Abrasive Coating Outside Lever	\$47.00
87	Tactile Warning - Abrasive Strip on Inside Push Rail & Coating on Outside Lever	\$148.00
* AL	Alarmed (not available with HC, HC4, 16-, 56- thru 59- options) (minimum Dr width 36")	\$595.00
BR	SARGENT Bump Resistant Cylinders (N/A w/10, 22, 30, 60, 63, 64, 70, 72, 73, 737P, KESO, SC, SE)	\$25.00 /cyl.
CPC	Clear Powder Coat – Recommended for exit devices used in full exterior application and highly corrosive areas with 32 and 32D finishes.	\$232.00
DG1	Patented Degree DG1 Key System	No addition
DG160	Hardware prepared for DG1-6300 Lg. Format IC cores, supplied with temporary plastic construction cores	No addition
DG163	Patented Degree DG1 Large Format Interchangeable Core Cylinder - Includes master keying charges	\$83.00
DG164	Hardware prepared for DG1-6300 Lg. Format IC cores, supplied with temporary keyed construction cores	\$83.00
DG2	Patented Degree DG2 Key System incorporating a locking sidebar	\$63.00/cyl.
DG260	Hardware prepared for DG2-6300 Lg. Format IC cores, supplied with temporary plastic construction cores	No addition
DG263	Patented Degree DG2 Large Format Interchangeable Core Cylinder - Includes master keying charges	\$146.00
DG264	Hardware prepared for DG2-6300 Lg. Format IC cores, supplied with temporary keyed construction cores	\$83.00
DG3	Patented Degree DG3 Key System incorporating a locking sidebar and UL437 listed	\$89.00/cyl.
DG360	Hardware prepared for DG3-6300 Lg. Format IC cores, supplied with temporary plastic construction cores	No addition
DG363	Patented Degree DG3 Large Format Interchangeable Core Cylinder - Includes master keying charges	\$172.00
DG364	Hardware prepared for DG3-6300 Lg. Format IC cores, supplied with temporary keyed construction cores	\$83.00
LC	Less Cylinder	-\$96.00/cyl.
LD	Less Dogging	No addition
PL	SARGuide™ PL – Photoluminescent Coating – (Pushbar w/o Lexan Touchpad - 19 option is supplied as standard)	\$376.00
NB	No Bottom Rod (Not available with 59 and BC59 option)	No addition
SC	Schlage C Keyway Cylinder 0-Bitted (Rim and #41 Mortise Cylinder Only)	No addition
SE	Schlage E Keyway Cylinder 0-Bitted (Rim and #41 Mortise Cylinder Only)	No addition
SG	MicroShield® an antimicrobial powder coat (not available with 10B)	\$88.00
TB	Thru Bolt	\$26.00
* TL	SARGuide™ – Illuminated Touchpad (not available with AL, 57, 59 options)	\$232.00

*** Exact door width required when ordering.**

Vertical Rod Device to 96" Height	No addition
Concealed/Surface Vertical Rod Device over 96" to 120" Height	\$64.00

Refer to catalog for max. door height availability on fire rated exit devices.



683 Thermal Pin Kit for use with 45/60/90 Minute Wood Doors

683	\$105.00
-----	----------

Experience a safer
and more open world

USA & Canada Prices Effective May 1, 2021



MD8600 Series-Concealed Vertical Rod Device			
 ET Control	 ET Control		
Standard Levers: A-B-E-F-J-L-P-W Coastal Levers: G-R-S-Y All Studio Collection Levers (Except Gramercy, Wooster Square, & Grant Park)	Gramercy Series: RAG-RAL-RAM-RAS-RCM-REM-RGM Wooster Square: H001-H002-H003-H004-H005-H006 Grant Park: H007-H008-H009-H010-H011	Auxiliary Control (106/113)	with 862, 863, 864 Pull Price includes 862 Pull (shown)
Finishes listed below are for the exit device. Refer to catalog for available trims, trim finishes and how to order.			

8600 Series			Finish					
Option	Function	Description	10BE/32D/ BSP/WSP	03/04/09/10/10B/ 10BL/20D/32	10BE/32D/ BSP/WSP	03/04/09/10/10B/ 10BL/20D/32	10BE/32D/ BSP/WSP	03/04/10/ 10B/32
MD	8610	Exit Only No Trim	\$2,944.00	\$3,107.00				
MD	8610	Dummy Trim (Lever rigid)	\$3,704.00	\$3,867.00	\$3,947.00	\$4,110.00	\$3,238.00	\$3,424.00
*MD	8610	Key operates control					\$3,998.00	\$4,184.00
MD	8606	Key operates ET						
MD	8613	Key locks/unlocks ET	\$3,704.00	\$3,867.00	\$3,947.00	\$4,110.00		
MD	8615	Trim always operable						

*When ordering Exits with Auxiliary Control Design, please order as follows: example: MD8610F x 106/113 x 862 x 32D x RHR

MD8600 Series With Freewheeling Trim								
MD	8640	Dummy Trim (Lever rotates)						
MD	8643	Key engages/disengages lever	\$3,704.00	\$3,867.00	\$3,947.00	\$4,110.00		
MD	8646	Key operates control						
MD8600 Series With Electro-Mechanical								
MD	8673	Fail Safe 12v or 24v						
MD	8674	Fail Secure 12v or 24v	\$4,016.00	\$4,179.00	\$4,209.00	\$4,372.00		

Note: Specify voltage required when ordering.

863 (18" x 1" Diameter) Pull provided in lieu of 862 (10" x 1" Diameter) Add \$72.00

864 (10" x 3/4" Diameter) Pull provided in lieu of 862 (10" x 1" Diameter) Deduct \$37.00

► Dummy Trim includes pull only, Auxiliary Control not supplied.

Thru Bolt Application		Pack Part #			Finish	
	No. Bolts per Pack	1-3/4" Dr.	2-1/4" Dr.	03/04/09/10/10B/10BE/10BL/20D/26D/BSP/WSP		
MD	8600	4	68-2279	68-2280	\$25.00 Pack	

Note: Cylinders not included when ordered less trim.

15 or 26D finishes are available on outside trim only, the exit devices will be supplied in 32D.

14 or 26 Finishes are available on outside trim only, the exit devices will be supplied in 32 finish.

WD8600 SERIES OPTIONS

USA & Canada Prices Effective May 1, 2021

Options	Description	Price
10	SARGENT Signature System	\$63.00 / cyl.
11	SARGENT XC Key System (not available w/10, 22, KESO, SC, & SE options)	No addition
1160	SARGENT XC Large Format Interchangeable Plastic Disposable Construction Core	No addition
1163	SARGENT XC Large Format Interchangeable Core Cylinder – Includes masterkeying charges	\$83.00
1164	SARGENT XC Large Format Interchangeable Construction Core Cylinder	\$83.00
1170	Small Format interchangeable disposable construction core - to accept 7 Pin XC permanent core	No addition
11727P	Small Format interchangeable keyed construction core - to accept 7 Pin XC permanent core	\$75.00
11737P	Small Format interchangeable core - to accept 7 pin XC permanent core	\$75.00 / cyl.
12	UL Fire Label Exit Devices (not available with 16- & HK options)	\$184.00
16	Cylinder lockdown feature in rail (not available with 12-, 57-, 59-, AL- options)	\$133.00
19	80 Series pushbar without Lexan touchpad	No addition
21	SARGENT Construction Key System (lost ball)	\$16.00 /cyl.
22	SARGENT Construction Key System (split key)	\$32.00 /cyl.
31	For doors greater than 1-3/4" and up to 2-1/4" (including those with auxiliary controls)	No addition
	For doors over 2-1/4"	Consult Factory
	For doors with panels (See catalog for ordering details)	No addition
36	6 Lobe security head screws	\$64.00
37	Spanner head screws	\$46.00
43	Flush End Cap	No addition
5CH	5lb. Pressure Release	\$64.00
* 53	Latchbolt Monitor Switch – Available with 55, 56, 57, 58, AL options	\$256.00
54	Internal Micro Switch in ET Control	\$232.00
* 55	Signal Switch in Rail	\$241.00
* 56	Remote Dogging / Latch Retraction (Minimum door width for narrow stile is 26" and wide stile is 28")	\$852.00
* HK56	Latch Retraction with Hex Key Dogging	\$852.00
* 57	Delayed Action (Magnet ordered separate)	\$1,407.00
* 58	Electric Dogging	\$487.00
* 59	Electroguard (Not available with 16, 53, 55, 56, 57, 58, NB options)	\$1,723.00
* BC59	Electroguard Boca Code (Needs Door Status Switch) (Not available with 16, 53, 55, 56, 57, 58, NB options)	\$1,829.00
60	SARGENT Large Format Interchangeable Plastic Disposable Construction Core	No addition
63	SARGENT Large Format Interchangeable Core Cylinder includes master and grandmaster keying charge	\$83.00 /cyl.
64	SARGENT Large Format Interchangeable Construction Core Cylinder	\$83.00
6573	Small Format 6 Pin Uncombined Core	\$65.00 / cyl.
65737P	Small Format 7 Pin Uncombined Core	\$65.00 / cyl.
70	Small Format Interchangeable Disposable construction plastic core	No addition
72	Small Format Interchangeable 6-Pin Construction Core (7-pin with 11 option)	\$75.00
73	Small Format 6-pin interchangeable core	\$75.00 / cyl.
737P	Small Format 7-pin interchangeable core	\$75.00 / cyl.
76	Tactile Warning - Milled Outside Lever (Not available with Studio, Coastal and the A Levers)	\$77.00
81	Cylinder to accept Keso (83) and Keso F1 (183) removable core – no core provided	No addition
F182	SARGENT Keso Security, patent pending, cylinder – new key systems	\$91.00 / cyl.
F183	SARGENT Keso Security, patent pending, removable core cylinder – new key systems	\$130.00 / cyl.
82	SARGENT Keso Security Cylinder (existing key systems only)	\$91.00 / cyl.
83	SARGENT Keso Security Removable Core Cylinder (existing key systems only)	\$130.00 / cyl.
84	SARGENT Keso Security Removable Construction Core Cylinder	See CK-18
85	Tactile Warning - Abrasive Strip Inside Push Rail	\$101.00
86	Tactile Warning - Abrasive Coating Outside Lever	\$47.00
87	Tactile Warning - Abrasive Strip on Inside Push Rail & Coating on Outside Lever	\$148.00
* AL	Alarmed (not available with HC, HC4, 16-, 56- thru 59- options) (minimum Dr width 36")	\$595.00
BR	SARGENT Bump Resistant Cylinders (N/A w/10, 22, 30, 60, 63, 64, 70, 72, 73, 737P, KESO, SC, SE)	\$25.00 /cyl.
CPC	Clear Powder Coat – Recommended for exit devices used in full exterior application and highly corrosive areas with 32 and 32D finishes.	\$232.00
DG1	Patented Degree DG1 Key System	No addition
DG160	Hardware prepared for DG1-6300 Lg. Format IC cores, supplied with temporary plastic construction cores	No addition
DG163	Patented Degree DG1 Large Format Interchangeable Core Cylinder - Includes master keying charges	\$83.00
DG164	Hardware prepared for DG1-6300 Lg. Format IC cores, supplied with temporary keyed construction cores	\$83.00
DG2	Patented Degree DG2 Key System incorporating a locking sidebar	\$63.00/cyl.
DG260	Hardware prepared for DG2-6300 Lg. Format IC cores, supplied with temporary plastic construction cores	No addition
DG263	Patented Degree DG2 Large Format Interchangeable Core Cylinder - Includes master keying charges	\$146.00
DG264	Hardware prepared for DG2-6300 Lg. Format IC cores, supplied with temporary keyed construction cores	\$83.00
DG3	Patented Degree DG3 Key System incorporating a locking sidebar and UL437 listed	\$89.00/cyl.
DG360	Hardware prepared for DG3-6300 Lg. Format IC cores, supplied with temporary plastic construction cores	No addition
DG363	Patented Degree DG3 Large Format Interchangeable Core Cylinder - Includes master keying charges	\$172.00
DG364	Hardware prepared for DG3-6300 Lg. Format IC cores, supplied with temporary keyed construction cores	\$83.00
LC	Less Cylinder	-\$96.00/cyl.
LD	Less Dogging	No addition
PL	SARGuide™ PL – Photoluminescent Coating – (Pushbar w/o Lexan Touchpad - 19 option is supplied as standard)	\$376.00
NB	No Bottom (Not available with 59 and BC59 option)	No addition
SC	Schlage C Keyway Cylinder 0-Bitted (Rim and #41 Mortise Cylinder Only)	No addition
SE	Schlage E Keyway Cylinder 0-Bitted (Rim and #41 Mortise Cylinder Only)	No addition
SG	MicroShield® an antimicrobial powder coat (not available with 10B)	\$88.00
TB	Thru Bolt	\$26.00
* TL	SARGuide™ – Illuminated Touchpad (not available with AL, 57, 59 options)	\$232.00

*** Exact door width required when ordering.**

Vertical Rod Device to 96" Height No addition

Concealed/Surface Vertical Rod Device over 96" to 120" Height \$64.00

Refer to catalog for max. door height availability on fire rated exit devices.





683 Thermal Pin Kit for use with 45/60/90 Minute Wood Doors

683 \$105.00

Experience a safer
and more open world

USA & Canada Prices Effective May 1, 2021



WD8600 Series-Concealed Vertical Rod Device			
 ET Control	 ET Control	 Auxiliary Control (106/113)	 with 862, 863, 864 Pull
Standard Levers: A-B-E-F-J-L-P-W Coastal Levers: G-R-S-Y All Studio Collection Levers (Except Gramercy, Wooster Square, & Grant Park)	Gramercy Series: RAG-RAL-RAM-RAS-RCM-REM-RGM Wooster Square: H001-H002-H003-H004-H005-H006 Grant Park: H007-H008-H009-H010-H011	Price includes 862 Pull (shown)	
Finishes listed below are for the exit device. Refer to catalog for available trims, trim finishes and how to order.			

WD8600 Series			Finish					
Option	Function	Description	10BE/32D/ BSP/WSP	03/04/09/10/10B/ 10BL/20D/32	10BE/32D/ BSP/WSP	03/04/09/10/10B/ 10BL/20D/32	10BE/32D/ BSP/WSP	03/04/10/ 10B/32
WD	8610	Exit Only No Trim	\$3,153.00	\$3,316.00				
WD	8610	Dummy Trim (Lever rigid)	\$3,913.00	\$4,076.00	\$4,156.00	\$4,319.00	\$3,447.00	\$3,633.00
*WD	8610	Key operates control					\$4,207.00	\$4,393.00
WD	8606	Key operates ET						
WD	8613	Key locks/unlocks ET	\$3,913.00	\$4,076.00	\$4,156.00	\$4,319.00		
WD	8615	Trim always operable						

*When ordering Exits with Auxiliary Control Design, please order as follows: example: WD8610F x 106/113 x 862 x 32D x RHR

WD8600 Series With Freewheeling Trim								
WD	8640	Dummy Trim (Lever rotates)						
WD	8643	Key engages/disengages lever	\$3,913.00	\$4,076.00	\$4,156.00	\$4,319.00		
WD	8646	Key operates control						
WD8600 Series With Electro-Mechanical								
WD	8673	Fail Safe 12v or 24v	\$4,225.00	\$4,388.00	\$4,418.00	\$4,581.00		
WD	8674	Fail Secure 12v or 24v						

Note: Specify voltage required when ordering.

863 (18" x 1" Diameter) Pull provided in lieu of 862 (10" x 1" Diameter) Add \$72.00

864 (10" x 3/4" Diameter) Pull provided in lieu of 862 (10" x 1" Diameter) Deduct \$37.00

► Dummy Trim includes pull only, Auxiliary Control not supplied.

Thru Bolt Application		Pack Part #			Finish	
	No. Bolts per Pack	1-3/4" Dr.	2-1/4" Dr.	03/04/09/10/10B/10BE/10BL/20D/26D/BSP/WSP		
WD	8600	4	68-2279	68-2280	\$25.00 Pack	

Note: Cylinders not included when ordered less trim.

15 or 26D finishes are available on outside trim only, the exit devices will be supplied in 32D.

14 or 26 Finishes are available on outside trim only, the exit devices will be supplied in 32 finish.

ED-24 EXIT DEVICES

SARGENT®

LS8600 • LP8600 • LR8600 SERIES OPTIONS

ASSA ABLOY

USA & Canada Prices Effective May 1, 2021

Options	Description	Price
10	SARGENT Signature System	\$63.00 / cyl.
11	SARGENT XC Key System (not available w/10, 22, KESO, SC, & SE options)	No addition
1160	SARGENT XC Large Format Interchangeable Plastic Disposable Construction Core	No addition
1163	SARGENT XC Large Format Interchangeable Core Cylinder – Includes masterkeying charges	\$83.00
1164	SARGENT XC Large Format Interchangeable Construction Core Cylinder	\$83.00
1170	Small Format interchangeable disposable construction core - to accept 7 Pin XC permanent core	No addition
11727P	Small Format interchangeable keyed construction core - to accept 7 Pin XC permanent core	\$75.00
11737P	Small Format interchangeable core - to accept 7 pin XC permanent core	\$75.00 / cyl.
12	UL Fire Label Exit Devices (not available with 16- & HK options)	\$184.00
16	Cylinder lockdown feature in rail (not available with 12- options)	\$133.00
19	Series pushbar without Lexan touchpad	No addition
21	SARGENT Construction Key System (lost ball)	\$16.00 / cyl.
22	SARGENT Construction Key System (split key)	\$32.00 / cyl.
36	6 Lobe security head screws	\$64.00
37	Spanner head screws	\$46.00
43	Flush End Cap	No addition
* 55	Signal Switch in Rail	\$241.00
* 56	Remote Dogging / Latch Retraction (Minimum door width for narrow stile is 26" and wide stile is 28")	\$852.00
* HK56	Latch Retraction with Hex Key Dogging	\$852.00
* 58	Electric Dogging	\$487.00
60	SARGENT Large Format Interchangeable Plastic Disposable Construction Core	No addition
63	SARGENT Large Format Interchangeable Core Cylinder includes master and grandmaster keying charge	\$83.00 / cyl.
64	SARGENT Large Format Interchangeable Construction Core Cylinder	\$83.00
6573	Small Format 6 Pin Uncombined Core	\$65.00 / cyl.
65737P	Small Format 7 Pin Uncombined Core	\$65.00 / cyl.
70	Small Format Interchangeable disposable Plastic construction core	No addition
72	Small Format Interchangeable 6-Pin Construction Core (7-pin with 11 option)	\$75.00
73	Small Format 6-Pin interchangeable core	\$75.00 / cyl.
737P	Small Format 7-pin interchangeable core	\$75.00 / cyl.
76	Tactile Warning - Milled Outside Lever (Not available with Studio, Coastal and the A Levers)	\$77.00
81	Cylinder to accept Keso (83) and Keso F1 (F183) removable core – no core provided	No addition
F182	SARGENT Keso Security, patent pending, cylinder – new key systems	\$91.00 / cyl.
F183	SARGENT Keso Security, patent pending, removable core cylinder – new key systems	\$130.00 / cyl.
82	SARGENT Keso Security Cylinder (existing key systems only)	\$91.00 / cyl.
83	SARGENT Keso Security Removable Core Cylinder (existing key systems only)	\$130.00 / cyl.
84	SARGENT Keso Security Removable Construction Core Cylinder	See CK-18
85	Tactile Warning - Abrasive Strip Inside Push Rail	\$101.00
86	Tactile Warning - Abrasive Coating Outside Lever	\$47.00
87	Tactile Warning - Abrasive Strip on Inside Push Rail & Coating on Outside Lever	\$148.00
BR	SARGENT Bump Resistant Cylinders (N/A w/10, 22, 30, 60, 63, 64, 70, 72, 73, 737P, KESO, SC, SE)	\$25.00 /cyl.
CPC	Clear Powder Coat – Recommended for exit devices used in full exterior application and highly corrosive areas with 32 and 32D finishes.	\$232.00
DG1	Patented Degree DG1 Key System	No addition
DG160	Hardware prepared for DG1-6300 Lg. Format IC cores, supplied with temporary plastic construction cores	No addition
DG163	Patented Degree DG1 Large Format Interchangeable Core Cylinder - Includes master keying charges	\$83.00
DG164	Hardware prepared for DG1-6300 Lg. Format IC cores, supplied with temporary keyed construction cores	\$83.00
DG2	Patented Degree DG2 Key System incorporating a locking sidebar	\$63.00/cyl.
DG260	Hardware prepared for DG2-6300 Lg. Format IC cores, supplied with temporary plastic construction cores	No addition
DG263	Patented Degree DG2 Large Format Interchangeable Core Cylinder - Includes master keying charges	\$146.00
DG264	Hardware prepared for DG2-6300 Lg. Format IC cores, supplied with temporary keyed construction cores	\$83.00
DG3	Patented Degree DG3 Key System incorporating a locking sidebar and UL437 listed	\$89.00/cyl.
DG360	Hardware prepared for DG3-6300 Lg. Format IC cores, supplied with temporary plastic construction cores	No addition
DG363	Patented Degree DG3 Large Format Interchangeable Core Cylinder - Includes master keying charges	\$172.00
DG364	Hardware prepared for DG3-6300 Lg. Format IC cores, supplied with temporary keyed construction cores	\$83.00
LC	Less Cylinder	-\$96.00/cyl.
LD	Less Dogging	No addition
PL	SARGuide™ PL – Photoluminescent Coating – (Pushbar w/o Lexan Touchpad - 19 option is supplied as standard)	\$376.00
SC	Schlage C Keyway Cylinder 0-Bitted (Rim and #41 Mortise Cylinder Only)	No addition
SE	Schlage E Keyway Cylinder 0-Bitted (Rim and #41 Mortise Cylinder Only)	No addition
SG	MicroShield® an antimicrobial powder coat (not available with 10B)	\$88.00
* TL	SARGuide™ – Illuminated Touchpad (not available with AL, 57, 59 options)	\$232.00

Only available for 36", 42", 44", 46" and 48" doors. No other sizes available.

***Exact door width required when ordering.**

Vertical Rod Device to 96" Height	No addition
Concealed/Surface Vertical Rod Device over 96" to 120" Height	\$64.00
Refer to catalog for max. door height availability on fire rated exit devices.	

Experience a safer
and more open world

Copyright © 2002-2021 Sargent Manufacturing Company, an ASSA ABLOY Group company. All rights reserved.
Reproduction in whole or in part without the express written permission of Sargent Manufacturing Company is prohibited.
Contact us at: 800-727-5477 or visit www.sargentlock.com. In Canada contact us at: 800-461-3007 or visit www.assaabloydss.ca

Low Profile Exit Device

Finishes listed below are for the exit device. Refer to catalog for available trims, trim finishes and how to order.



Standard Levers:
A-B-E-F-J-L-P-W
Coastal Levers:
G-R-S-Y
All Studio Collection Levers
(Except Gramercy, Wooster Square, & Grant Park)

USA & Canada Prices Effective May 1, 2021



Gramercy Series:
RAG-RAL-RAM-RAS-
RCM-REM-RGM
Wooster Square:
H001-H002-H003-H004-H005-H006
Grant Park:
H007-H008-H009-H010-H011

LS8600 Series Single Door Projecting Bolt Function			Finish			
Options	Function	Description	10BE/32D/ BSP/WSP	03/04/09/10/10B/ 10BL/20D/32	10BE/32D/ BSP/WSP	03/04/09/10/10B/ 10BL/20D/32
LS	8610	Exit Only - No Trim	\$3,025.00	\$3,188.00		
LS	8610	Dummy Trim (Lever rigid)				
LS	8606	Key operates control				
LS	8613	Key locks/unlocks control	\$3,785.00	\$3,948.00	\$4,028.00	\$4,191.00
LS	8615	Trim controls always operable				
*LS	8673	Fail Safe 12v or 24v	\$4,097.00	\$4,260.00	\$4,290.00	\$4,453.00
*LS	8674	Fail Secure 12v or 24v				
LS8600 Series With Freewheeling Trim						
LS	8640	Dummy Trim (Lever rotates)				
LS	8643	Key engages/disengages lever	\$3,785.00	\$3,948.00	\$4,028.00	\$4,191.00
LS	8646	Key operates control				
LP8600 Series Pair of Doors Projecting Bolt (For Active Door)						
LP	8610	Exit Only - No Trim	\$3,025.00	\$3,188.00		
LP	8610	Dummy Trim (Lever rigid)				
LP	8606	Key operates control				
LP	8613	Key locks/unlocks control	\$3,785.00	\$3,948.00	\$4,028.00	\$4,191.00
LP	8615	Trim controls always operable				
*LP	8673	Fail Safe 12v or 24v	\$4,097.00	\$4,260.00	\$4,290.00	\$4,453.00
*LP	8674	Fail Secure 12v or 24v				
LP8600 Series With Freewheeling Trim						
LP	8640	Dummy Trim (Lever rotates)				
LP	8643	Key engages/disengages lever	\$3,785.00	\$3,948.00	\$4,028.00	\$4,191.00
LP	8646	Key operates control				
LR8600 Series Pair of Doors Recessed Bolt (For Inactive Door)						
LR	8610	Exit Only - No Trim	\$3,025.00	\$3,188.00		
LR	8610	Dummy Trim (Lever rigid)				
LR	8606	Key operates control				
LR	8613	Key locks/unlocks control	\$3,785.00	\$3,948.00	\$4,028.00	\$4,191.00
LR	8615	Trim controls always operable				
*LR	8673	Fail Safe 12v or 24v	\$4,097.00	\$4,260.00	\$4,290.00	\$4,453.00
*LR	8674	Fail Secure 12v or 24v				
LR8600 Series With Freewheeling Trim						
LR	8640	Dummy Trim (Lever rotates)				
LR	8643	Key engages/disengages lever	\$3,785.00	\$3,948.00	\$4,028.00	\$4,191.00
LR	8646	Key operates control				

NOTE:

*LS/LP/LR8673 and 8674 – Specify voltage required when ordering.

Cylinders not included when ordered less trim.

15 or 26D finishes are available on outside trim only, the exit devices will be supplied in 32D.

14 or 26 Finishes are available on outside trim only, the exit devices will be supplied in 32 finish.

8700 SERIES OPTIONS

USA & Canada Prices Effective May 1, 2021





Options	Description	Price
10	SARGENT Signature System	\$63.00 / cyl.
11	SARGENT XC Key System (not available w/10, 22, KESO, SC, & SE options)	No addition
1160	SARGENT XC Large Format Interchangeable Plastic Disposable Construction Core	No addition
1163	SARGENT XC Large Format Interchangeable Core Cylinder – Includes masterkeying charges	\$83.00
1164	SARGENT XC Large Format Interchangeable Construction Core Cylinder	\$83.00
1170	Small Format interchangeable disposable construction core - to accept 7 Pin XC permanent core	No addition
11727P	Small Format interchangeable keyed construction core - to accept 7 Pin XC permanent core	\$75.00
11737P	Small Format interchangeable core - to accept 7 pin XC permanent core	\$75.00 / cyl.
12	UL Fire Label Exit Devices (not available with 16- & HK options)	\$184.00
14	Sliding bolt bottom case for 8700 Series	No addition
16	Cylinder lockdown feature in rail (not available with 12-, 57-, 59-, AL- options)	\$133.00
19	80 Series pushbar without Lexan touchpad	No addition
21	SARGENT Construction Key System (lost ball)	\$16.00 / cyl.
22	SARGENT Construction Key System (split key)	\$32.00 / cyl.
31	For doors greater than 1-3/4" and up to 2-1/4" (including those with auxiliary controls) For doors over 2-1/4" For doors with panels (See catalog for ordering details)	No addition Consult Factory No addition
36	6 Lobe security head screws	\$96.00
37	Spanner head screws	\$62.00
43	Flush End Cap	No addition
* 53	Latchbolt Monitor Switch – available with 55, 56, 57, 58, AL options – not available with NB	\$256.00
54	Internal Micro Switch in ET Control	\$232.00
* 55	Signal Switch in Rail	\$241.00
* 56	Remote Dogging / Latch Retraction (Minimum door width for narrow stile is 26" and wide stile is 28")	\$852.00
* HK56	Latch Retraction with Hex Key Dogging	\$852.00
* 57	Delayed Action (Magnet ordered separate)	\$1,407.00
* 58	Electric Dogging	\$487.00
* 59	Electroguard (Not available with 16-, 53-, 55-, 56-, 57-, 58- Options)	\$1,723.00
* BC59	Electroguard Boca Code (Needs Door Status Switch) (Not available with 16-, 53-, 55-, 56-, 57-, 58- Options)	\$1,829.00
60	SARGENT Large Format Interchangeable Plastic Disposable Construction Core	No addition
63	SARGENT Large Format Interchangeable Core Cylinder includes master and grandmaster keying charge	\$83.00 /cyl.
64	SARGENT Large Format Interchangeable Construction Core Cylinder	\$83.00
6573	Small Format 6 Pin Uncombined Core	\$65.00 / cyl.
65737P	Small Format 7 Pin Uncombined Core	\$65.00 / cyl.
70	Small Format Interchangeable Disposable plastic construction core	No addition
72	Small Format Interchangeable 6-Pin Construction Core (7-pin with 11 option)	\$75.00
73	Small Format 6-pin interchangeable core	\$75.00 / cyl.
737P	Small Format 7-pin interchangeable core	\$75.00 / cyl.
76	Tactile Warning - Milled Outside Lever (Not available with Studio, Coastal and the A Levers)	\$77.00
81	Cylinder to accept Keso (83) and Keso F1 (F183) removable core – no core provided	No addition
F182	SARGENT Keso Security, patent pending, cylinder – new key systems	\$91.00 / cyl.
F183	SARGENT Keso Security, patent pending, removable core cylinder – new key systems	\$130.00 / cyl.
82	SARGENT Keso Security Cylinder (existing key systems only)	\$91.00 / cyl.
83	SARGENT Keso Security Removable Core Cylinder (existing key systems only)	\$130.00 / cyl.
84	SARGENT Keso Security Removable Construction Core Cylinder	See CK-18
85	Tactile Warning - Abrasive Strip Inside Push Rail	\$101.00
86	Tactile Warning - Abrasive Coating Outside Lever	\$47.00
87	Tactile Warning - Abrasive Strip on Inside Push Rail & Coating on Outside Lever	\$148.00
* AL	Alarmed (not available with HC, HC4, 16-, 56- thru 59- options)	\$595.00
BR	SARGENT Bump Resistant Cylinders (N/A w/10, 22, 30, 60, 63, 64, 70, 72, 73, 737P, KESO, SC, SE)	\$25.00 /cyl.
CPC	Clear Powder Coat – Rec. for Exit Dvcs. used in full ext. appl. & highly corrosive areas w/32 & 32D finishes.	\$232.00
DG1	Patented Degree DG1 Key System	No addition
DG160	Hardware prepared for DG1-6300 Lg. Format IC cores, supplied with temporary plastic construction cores	No addition
DG163	Patented Degree DG1 Large Format Interchangeable Core Cylinder - Includes master keying charges	\$83.00
DG164	Hardware prepared for DG1-6300 Lg. Format IC cores, supplied with temporary keyed construction cores	\$83.00
DG2	Patented Degree DG2 Key System incorporating a locking sidebar	\$63.00/cyl.
DG260	Hardware prepared for DG2-6300 Lg. Format IC cores, supplied with temporary plastic construction cores	No addition
DG263	Patented Degree DG2 Large Format Interchangeable Core Cylinder - Includes master keying charges	\$146.00
DG264	Hardware prepared for DG2-6300 Lg. Format IC cores, supplied with temporary keyed construction cores	\$83.00
DG3	Patented Degree DG3 Key System incorporating a locking sidebar and UL437 listed	\$89.00/cyl.
DG360	Hardware prepared for DG3-6300 Lg. Format IC cores, supplied with temporary plastic construction cores	No addition
DG363	Patented Degree DG3 Large Format Interchangeable Core Cylinder - Includes master keying charges	\$172.00
DG364	Hardware prepared for DG3-6300 Lg. Format IC cores, supplied with temporary keyed construction cores	\$83.00
HC	Hurricane Code	\$130.00
12HC	UL Fire Label Hurricane Code	\$314.00
HC4	Hurricane-Resistant	\$248.00
12HC4	UL Fire Label Hurricane Code	\$432.00
LC	Less Cylinder	-\$96.00/cyl.
LD	Less Dogging	No addition
PL	SARGuide™ PL – Photoluminescent Coating – (Pushbar w/o Lexan Touchpad - 19 option is supplied as standard)	\$376.00
SC	Schlage C Keyway Cylinder 0-Bitted (Rim and #41 Mortise Cylinder Only)	No addition
SE	Schlage E Keyway Cylinder 0-Bitted (Rim and #41 Mortise Cylinder Only)	No addition
SG	MicroShield® an antimicrobial powder coat (not available with 10B)	\$88.00
TB	Thru Bolt	\$78.00
* TL	SARGuide™ – Illuminated Touchpad (not available with AL, 57, 59 options)	\$232.00

* Exact door width required when ordering.

Vertical Rod Device to 96" Height No addition • Concealed/Surface Vertical Rod Device over 96" to 120" Height \$64.00
Refer to catalog for max. door height availability on fire rated exit devices.

Experience a safer
and more open world



8700 Series-Surface Vertical Rod Device			
 ET Control	 ET Control	 PTB STS-MAL-FLL-FLW	  306/313 Auxiliary Control with 862, 863 864 Pull Price includes 862 Pull (shown)
Standard Levers: A-B-E-F-J-L-P-W Coastal Levers: G-R-S-Y All Studio Collection Levers (Except Gramercy, Wooster Square, & Grant Park)	Gramercy Series: RAG-RAL-RAM-RAS-RCM-REM-RGM Wooster Square: H001-H002-H003-H004-H005-H006 Grant Park: H007-H008-H009-H010-H011		
Finishes listed below are for the exit device. Refer to catalog for available trims, trim finishes and how to order.			

8700 Series	Function Description	Finish					
		03/04/09/ 10BE/32D/ BSP/WSP	10/10B/10BL/ 20D/32	03/04/09/ 10BE/32D/ BSP/WSP	10/10B/10BL/ 20D/32	03/04/09/ 10BE/32D/ BSP/WSP	10/10B/10BL/ 20D/32
8710	Exit Only - No Trim	\$2,554.00	\$2,729.00				
8710	Dummy Trim (Lever rigid)	\$3,314.00	\$3,489.00	\$3,557.00	\$3,732.00	\$3,015.00	\$3,190.00
*8710	Key operates control						\$2,848.00 ▶ \$3,046.00 ▶
8706	Key operates ET						\$3,608.00 \$3,806.00
8713	Key locks/unlocks ET	\$3,314.00	\$3,489.00	\$3,557.00	\$3,732.00		
8715	Trim always operable						
8728	Thumb pc.always operable						
8762	Key operates Thumb piece					\$3,099.00	\$3,274.00
8763	Key Locks/unlocks Thumb pc.						

*When ordering Exits with Auxiliary Control Design, please order as follows: example: 8710F x 306/313 x 862 x 32D x RHR

8700 Series With Freewheeling Trim							
8740	Dummy Trim (Lever rotates)						
8743	Key engages/disengages lever	\$3,314.00	\$3,489.00	\$3,557.00	\$3,732.00		
8746	Key operates control						
8700 Series With Electro-Mechanical							
8773	Fail Safe 12v or 24v	\$3,626.00	\$3,801.00	\$3,819.00	\$3,994.00		
8774	Fail Secure 12v or 24v						

Note: Specify voltage required when ordering.

863 (18" x 1" Diameter) Pull provided in lieu of 862 (10" x 1" Diameter) Add \$72.00

864 (10" x 3/4" Diameter) Pull provided in lieu of 862 (10" x 1" Diameter) Deduct \$37.00

▶ Dummy Trim includes pull only, Auxiliary Control not supplied.

Thru Bolt Application	No. Bolts per Pack	Pack Part #		Finish
		1-3/4" Dr.	2 1/4" Dr.	
8700 Rail & Chassis	4	68-2279	68-2280	\$25.00 Pack
8700 Cases & Guides	10	68-2282	68-2283	\$61.00 Pack
12-8700	16	68-2288	68-2289	\$92.00 Pack

NOTES:

Cylinders not included when ordered less trim.

15 or 26D finishes are available on outside trim only, the exit devices will be supplied in 32D.

14 or 26 Finishes are available on outside trim only, the exit devices will be supplied in 32 finish.

8700 SERIES OPTIONS



USA & Canada Prices Effective May 1, 2021

Options	Description	Price
10	SARGENT Signature System	\$63.00 / cyl.
11	SARGENT XC Key System (not available w/10, 22, KESO, SC, & SE options)	No addition
1160	SARGENT XC Large Format Interchangeable Plastic Disposable Construction Core	No addition
1163	SARGENT XC Large Format Interchangeable Core Cylinder – Includes masterkeying charges	\$83.00
1164	SARGENT XC Large Format Interchangeable Construction Core Cylinder	\$83.00
1170	Small Format interchangeable disposable construction core - to accept 7 Pin XC permanent core	No addition
11727P	Small Format interchangeable keyed construction core - to accept 7 Pin XC permanent core	\$75.00
11737P	Small Format interchangeable core - to accept 7 pin XC permanent core	\$75.00 / cyl.
12	UL Fire Label Exit Devices (not available with 16- & HK options)	\$184.00
16	Cylinder lockdown feature in rail (not available with 12-, 57-, AL- options)	\$133.00
19	80 Series pushbar without Lexan touchpad	No addition
21	SARGENT Construction Key System (lost ball)	\$16.00 / cyl.
22	SARGENT Construction Key System (split key)	\$32.00 / cyl.
31	For doors greater than 1-3/4" and up to 2-1/4" (including those with auxiliary controls)	No addition
	For doors over 2-1/4"	Consult Factory
	For doors with panels (See catalog for ordering details)	No addition
36	6 Lobe security head screws	\$96.00
37	Spanner head screws	\$62.00
43	Flush End Cap	No addition
* 53	Latchbolt Monitor Switch – available with 55, 56, 57, 58, AL options	\$256.00
54	Internal Micro Switch in ET Control	\$232.00
* 55	Signal Switch in Rail	\$241.00
* 56	Remote Dogging / Latch Retraction (Minimum door width for narrow stile is 26" and wide stile is 28")	\$852.00
* HK56	Latch Retraction with Hex Key Dogging	\$852.00
* 57	Delayed Action (Magnet ordered separate)	\$1,407.00
* 58	Electric Dogging	\$487.00
59	Electroguard (Not available with 16, 53, 55, 56, 57, 58, NB prefixes)	\$1,723.00
60	SARGENT Large Format Interchangeable Plastic Disposable Construction Core	No addition
63	SARGENT Large Format Interchangeable Core Cylinder includes master and grandmaster keying charge	\$83.00 /cyl.
64	SARGENT Large Format Interchangeable Construction Core Cylinder	\$83.00
6573	Small Format 6 Pin Uncombined Core	\$65.00 / cyl.
65737P	Small Format 7 Pin Uncombined Core	\$65.00 / cyl.
70	Small Format Interchangeable Disposable plastic construction core	No addition
72	Small Format Interchangeable 6-Pin Construction Core (7-pin with 11 option)	\$75.00
73	Small Format 6-pin interchangeable core	\$75.00 / cyl.
737P	Small Format 7-pin interchangeable core	\$75.00 / cyl.
76	Tactile Warning - Milled Outside Lever (Not available with Studio, Coastal and the A Levers)	\$77.00
81	Cylinder to accept Keso (83) and Keso F1 (F183) removable core – no core provided	No addition
F182	SARGENT Keso Security, patent pending, cylinder – new key systems	\$91.00 / cyl.
F183	SARGENT Keso Security, patent pending, removable core cylinder – new key systems	\$130.00 / cyl.
82	SARGENT Keso Security Cylinder (existing key systems only)	\$91.00 / cyl.
83	SARGENT Keso Security Removable Core Cylinder (existing key systems only)	\$130.00 / cyl.
84	SARGENT Keso Security Removable Construction Core Cylinder	See CK-18
85	Tactile Warning - Abrasive Strip Inside Push Rail	\$101.00
86	Tactile Warning - Abrasive Coating Outside Lever	\$47.00
87	Tactile Warning - Abrasive Strip on Inside Push Rail & Coating on Outside Lever	\$148.00
* AL	Alarmed (not available with HC, HC4, 16-, 56- thru 59- options)	\$595.00
BR	SARGENT Bump Resistant Cylinders (N/A w/10, 22, 30, 60, 63, 64, 70, 72, 73, 737P, KESO, SC, SE)	\$25.00 /cyl.
CPC	Clear Powder Coat – Recommended for exit devices used in full exterior application and highly corrosive areas with 32 and 32D finishes.	\$232.00
DG1	Patented Degree DG1 Key System	No addition
DG160	Hardware prepared for DG1-6300 Lg. Format IC cores, supplied with temporary plastic construction cores	No addition
DG163	Patented Degree DG1 Large Format Interchangeable Core Cylinder - Includes master keying charges	\$83.00
DG164	Hardware prepared for DG1-6300 Lg. Format IC cores, supplied with temporary keyed construction cores	\$83.00
DG2	Patented Degree DG2 Key System incorporating a locking sidebar	\$63.00/cyl.
DG260	Hardware prepared for DG2-6300 Lg. Format IC cores, supplied with temporary plastic construction cores	No addition
DG263	Patented Degree DG2 Large Format Interchangeable Core Cylinder - Includes master keying charges	\$146.00
DG264	Hardware prepared for DG2-6300 Lg. Format IC cores, supplied with temporary keyed construction cores	\$83.00
DG3	Patented Degree DG3 Key System incorporating a locking sidebar and UL437 listed	\$89.00/cyl.
DG360	Hardware prepared for DG3-6300 Lg. Format IC cores, supplied with temporary plastic construction cores	No addition
DG363	Patented Degree DG3 Large Format Interchangeable Core Cylinder - Includes master keying charges	\$172.00
DG364	Hardware prepared for DG3-6300 Lg. Format IC cores, supplied with temporary keyed construction cores	\$83.00
LC	Less Cylinder	-\$96.00/cyl.
LD	Less Dogging	No addition
PL	SARGuide™ PL – Photoluminescent Coating – (Pushbar w/o Lexan Touchpad - 19 option is supplied as standard)	\$376.00
SC	Schlage C Keyway Cylinder 0-Bitted (Rim and #41 Mortise Cylinder)	No addition
SE	Schlage E Keyway Cylinder 0-Bitted (Rim and #41 Mortise Cylinder Only)	No addition
SG	MicroShield® an antimicrobial powder coat (not available with 10B)	\$88.00
TB	Thru Bolt	\$78.00
* TL	SARGuide™ – Illuminated Touchpad (not available with AL, 57, 59 options)	\$232.00
* Exact door width required when ordering.		
	Vertical Rod Device to 96" Height	No addition
	Concealed/Surface Vertical Rod Device over 96" to 120" Height	\$60.00
	Refer to catalog for max. door height availability on fire rated exit devices.	
	Vertical Rod Device to 96" Height	No addition
683 Thermal Pin Kit for use with 45/60/90 Minute Wood Doors		
683		\$93.00

Experience a safer
and more open world

USA & Canada Prices Effective May 1, 2021



8700 Series-Surface Vertical Rod Device, No Bottom Rod		
 ET Control	 ET Control	
Standard Levers: A-B-E-F-J-L-P-W Coastal Levers: G-R-S-Y All Studio Collection Levers (Except Gramercy, Wooster Square, & Grant Park)	Gramercy Series: RAG-RAL-RAM-RAS- -RCM-REM-RGM Wooster Square: H001-H002-H003-H004- H005-H006 Grant Park: H007-H008-H009-H010-H011	306/313 with Auxiliary 862, 863 Control 864 Pull Price includes 862 Pull (shown)
Finishes listed below are for the exit device. Refer to catalog for available trims, trim finishes and how to order.		

NB8700 Series			Finish					
			10BE/32D/ BSP/WSP	03/04/09/ 10/10B/10BL/ 20D/32	10BE/32D/ BSP/WSP	03/04/09/ 10/10B/10BL/ 20D/32	10BE/32D/ BSP/WSP	03/04/ 10/10B/ 32
NB	8710	Exit Only - No Trim	\$2,554.00	\$2,729.00				
NB	8710	Dummy Trim (Lever rigid)	\$3,314.00	\$3,489.00	\$3,557.00	\$3,732.00	\$2,848.00	\$3,046.00
*NB	8710	Key operates control					\$3,608.00	\$3,806.00
NB	8706	Key operates ET						
NB	8713	Key locks/unlocks ET	\$3,314.00	\$3,489.00	\$3,557.00	\$3,732.00		
NB	8715	Trim always operable						

*When ordering Exits with Auxiliary Control Design, please order as follows: example: NB8710F x 306/313 x 862 x 32D x RHR

NB8700 Series Freewheeling Trim						
NB	8740	Dummy Trim (Lever rotates)				
NB	8743	Key engages/disengages lever	\$3,314.00	\$3,489.00	\$3,557.00	\$3,732.00
NB	8746	Key operates control				

NB8700 Series Electro-Mechanical						
NB	8773	Fail Safe 12v or 24v				
NB	8774	Fail Secure 12v or 24v	\$3,626.00	\$3,801.00	\$3,819.00	\$3,994.00

Note: Specify voltage required when ordering.

863 (18" x 1" Diameter) Pull provided in lieu of 862 (10" x 1" Diameter) Add \$72.00

864 (10" x 3/4" Diameter) Pull provided in lieu of 862 (10" x 1" Diameter) Deduct \$37.00

► Dummy Trim includes pull only, Auxiliary Control not supplied.

Thru Bolt Application	No. Bolts Per Pack	Pack Part #	Finish	
			1-3/4" Dr.	2 1/4" Dr.
NB 8700 Rail/Chassis/Case/Guides	10	68-3943 68-2289	03/09/10/10B/10BE/10BL/20D/26DBSP/WSP	\$71.00 Pack
12-NB 8700 Rail/Chassis/Case/Guides	10	68-3943 68-2289		\$71.00 Pack

NOTES:

Cylinders not included when ordered less trim.

15 or 26D finishes are available on outside trim only, the exit devices will be supplied in 32D.

14 or 26 Finishes are available on outside trim only, the exit devices will be supplied in 32 finish.

FM8700 SERIES OPTIONS

USA & Canada Prices Effective May 1, 2021



Options	Description	Price
10	SARGENT Signature System	\$63.00 / cyl.
11	SARGENT XC Key System (not available w/10, 22, KESO, SC, & SE options)	No addition
1160	SARGENT XC Large Format Interchangeable Plastic Disposable Construction Core	No addition
1163	SARGENT XC Large Format Interchangeable Core Cylinder – Includes masterkeying charges	\$83.00
1164	SARGENT XC Large Format Interchangeable Construction Core Cylinder	\$83.00
1170	Small Format interchangeable disposable construction core - to accept 7 Pin XC permanent core	No addition
11727P	Small Format interchangeable keyed construction core - to accept 7 Pin XC permanent core	\$75.00
11737P	Small Format interchangeable core - to accept 7 pin XC permanent core	\$75.00 / cyl.
12	UL fire label Exit Devices	\$184.00
21	SARGENT Construction Key System (lost ball)	\$16.00 / cyl.
22	SARGENT Construction Key System (split key)	\$32.00 / cyl.
36	6 Lobe security head screws	\$96.00
37	Spanner head screws	\$62.00
43	Flush End Cap	No addition
* 54	Internal Micro Switch in ET Control	\$232.00
60	SARGENT Large Format Interchangeable Plastic Disposable Construction Core	No addition
63	SARGENT Large Format Interchangeable Core Cylinder includes master and grandmaster keying charge	\$83.00 / cyl.
64	SARGENT Large Format Interchangeable Construction Core Cylinder	\$83.00
6573	Small Format 6 Pin Uncombined Core	\$65.00 / cyl.
65737P	Small Format 7 Pin Uncombined Core	\$65.00 / cyl.
70	Small Format Interchangeable Disposable plastic construction core	No addition
72	Small Format Interchangeable 6-Pin Construction Core (7-pin wth 11 option)	\$75.00
73	Small Format 6-pin interchangeable core	\$75.00 / cyl.
737P	Small Format 7-pin interchangeable core	\$75.00 / cyl.
76	Tactile Warning - Milled Outside Lever (Not available with Studio, Coastal and the A Levers)	\$77.00
81	Cylinder to accept Keso (83) and Keso F1 (F183) removable core – no core provided	No addition
F182	SARGENT Keso Security, patent pending, cylinder – new key systems	\$91.00 / cyl.
F183	SARGENT Keso Security, patent pending, removable core cylinder – new key systems	\$130.00 / cyl.
82	SARGENT Keso Security Cylinder (existing key systems only)	\$91.00 / cyl.
83	SARGENT Keso Security Removable Core Cylinder (existing key systems only)	\$130.00 / cyl.
84	SARGENT Keso Security Removable Construction Core Cylinder	See CK-18
85	Tactile Warning - Abrasive Strip Inside Push Rail	\$101.00
86	Tactile Warning - Abrasive Coating Outside Lever	\$47.00
87	Tactile Warning - Abrasive Strip on Inside Push Rail & Coating on Outside Lever	\$148.00
BR	SARGENT Bump Resistant Cylinders (N/A w/10, 22, 30, 60, 63, 64, 70, 72, 73, 737P, KESO, SC, SE)	\$25.00 /cyl.
CPC	Clear Powder Coat – Recommended for exit devices used in full exterior application and highly corrosive areas with 32 and 32D finishes.	\$232.00
DG1	Patented Degree DG1 Key System	No addition
DG160	Hardware prepared for DG1-6300 Lg. Format IC cores, supplied with temporary plastic construction cores	No addition
DG163	Patented Degree DG1 Large Format Interchangeable Core Cylinder - Includes master keying charges	\$83.00
DG164	Hardware prepared for DG1-6300 Lg. Format IC cores, supplied with temporary keyed construction cores	\$83.00
DG2	Patented Degree DG2 Key System incorporating a locking sidebar	\$63.00/cyl.
DG260	Hardware prepared for DG2-6300 Lg. Format IC cores, supplied with temporary plastic construction cores	No addition
DG263	Patented Degree DG2 Large Format Interchangeable Core Cylinder - Includes master keying charges	\$146.00
DG264	Hardware prepared for DG2-6300 Lg. Format IC cores, supplied with temporary keyed construction cores	\$83.00
DG3	Patented Degree DG3 Key System incorporating a locking sidebar and UL437 listed	\$89.00/cyl.
DG360	Hardware prepared for DG3-6300 Lg. Format IC cores, supplied with temporary plastic construction cores	No addition
DG363	Patented Degree DG3 Large Format Interchangeable Core Cylinder - Includes master keying charges	\$172.00
DG364	Hardware prepared for DG3-6300 Lg. Format IC cores, supplied with temporary keyed construction cores	\$83.00
LC	Less Cylinder	-\$96.00/cyl.
LD	Less Dogging	No addition
SC	Schlage C Keyway Cylinder 0-Bitted (Rim and #41 Mortise Cylinder)	No addition
SE	Schlage E Keyway Cylinder 0-Bitted (Rim and #41 Mortise Cylinder Only)	No addition
SG	MicroShield® an antimicrobial powder coat (not available with 10B)	\$88.00
TB	Thru Bolt	\$78.00

*** Exact door width required when ordering.**

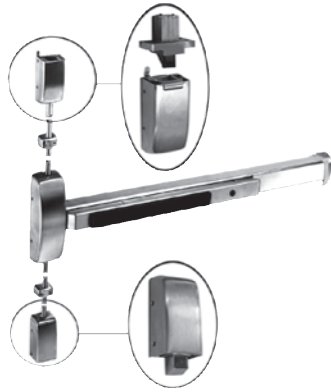
Max Door Height 96"
Available for "E" & "F" rails only



FM8700 Series-Surface Vertical Rod Device – 2 Pt. Latching, complies with FEMA 361

ET Control	ET Control	
		
Standard Levers: A-B-E-F-J-L-P-W Coastal Levers: G-R-S-Y All Studio Collection Levers (Except Gramercy, Wooster Square, & Grant Park)	Gramercy Series: RAG-RAL-FAM-RAS-RCM-REM-RGM Wooster Square: H001-H002-H003-H004-H005-H006 Grant Park: H007-H008-H009-H010-H011	306/313 with Auxiliary Control 862, 863 864 Pull Price includes 862 Pull (shown)
Finishes listed below are for the exit device. Refer to catalog for available trims, trim finishes and how to order.		

FM8700 Series			Finish					
Option	Function	Description	10BE/32D/ BSP/WSP	03/04/ 09/10/10B/ 10BL/20D/32	10BE/32D/ BSP/WSP	03/04/ 09/10/10B/ 10BL/20D/32	10BE/32D/ BSP/WSP	03/04/ 10/10B/ 32
FM	8710	Exit Only - No Trim	\$3,690.00	\$3,865.00				
FM	8710	Dummy Trim (Lever rigid)	\$4,450.00	\$4,625.00	\$4,693.00	\$4,868.00	\$3,984.00 ▶	\$4,182.00 ▶
*FM	8710	Key operates control					\$4,744.00	\$4,942.00
FM	8706	Key operates ET						
FM	8713	Key locks/unlocks ET	\$4,450.00	\$4,625.00	\$4,693.00	\$4,868.00		
FM	8715	Trim always operable						

*When ordering Exits with Auxiliary Control Design, please order as follows: example: FM8710F x 306/313 x 862 x 32D x RHR

FM8700 Series With Freewheeling Trim								
FM	8740	Dummy Trim (Lever rotates)						
FM	8743	Key engages/disengages lever	\$4,450.00	\$4,625.00	\$4,693.00	\$4,868.00		
FM	8746	Key operates control						
FM8700 Series With Electro-Mechanical								
FM	8773	Fail Safe 12v or 24v	\$4,762.00	\$4,937.00	\$4,955.00	\$5,130.00		
FM	8774	Fail Secure 12v or 24v						

Note: Specify voltage required when ordering.

863 (18" x 1" Diameter) Pull provided in lieu of 862 (10" x 1" Diameter)

Add \$72.00 ▶

864 (10" x 3/4" Diameter) Pull provided in lieu of 862 (10" x 1" Diameter)

Deduct \$37.00 ▶

▶ Dummy Trim includes pull only, Auxiliary Control not supplied.

Thru Bolt Application			No. Bolts Per Pack	Pack Part #		Finish
				1-3/4" Dr.	2 1/4" Dr.	03/09/10/10B/10BE/10BL/20D/26D/BSP/WSP
FM	8700	Rail & Chassis	4	68-2279	68-2280	\$25.00 Pack
FM	8700	Cases & Guides	10	68-2282	68-2283	\$61.00 Pack
FM	12-8700		16	68-2288	68-2289	\$92.00 Pack

NOTES:

Cylinders not included when ordered less trim.

15 or 26D finishes are available on outside trim only, the exit devices will be supplied in 32D.

14 or 26 Finishes are available on outside trim only, the exit devices will be supplied in 32 finish.

ED-32 EXIT DEVICES

SARGENT®

ASSA ABLOY

8800 SERIES OPTIONS

USA & Canada Prices Effective May 1, 2021





Options	Description	Price
10	SARGENT Signature System	\$63.00 / cyl.
11	SARGENT XC Key System (not available w/10, 22, KESO, SC, & SE options)	No addition
1160	SARGENT XC Large Format Interchangeable Plastic Disposable Construction Core	No addition
1163	SARGENT XC Large Format Interchangeable Core Cylinder – Includes masterkeying charges	\$83.00
1164	SARGENT XC Large Format Interchangeable Construction Core Cylinder	\$83.00
1170	Small Format interchangeable disposable construction core - to accept 7 Pin XC permanent core	No addition
11727P	Small Format interchangeable keyed construction core - to accept 7 Pin XC permanent core	\$75.00
11737P	Small Format interchangeable core - to accept 7 pin XC permanent core	\$75.00 / cyl.
12	UL Fire Label Exit Devices (not available with 16- & HK options)	\$184.00
16	Cylinder lockdown feature in rail (not available with 12-, 57-, 59-, AL- options)	\$133.00
19	80 Series pushbar without Lexan touchpad	No addition
21	SARGENT Construction Key System (lost ball)	\$16.00 /cyl.
22	SARGENT Construction Key System (split key)	\$32.00 /cyl.
31	For doors greater than 1-3/4" and up to 2-1/4" (including those with auxiliary controls)	No addition
	For doors over 2-1/4"	Consult Factory
	For doors with panels (See catalog for ordering details)	No addition
36	6 Lobe security head screws	\$52.00
37	Spanner head screws	\$33.00
43	Flush End Cap	No addition
49	Lock/unlock indicator option (available with 8816 and 8866 functions only)	\$350.00
5CH	5lb Pressure Release	\$30.00
* 53	Latchbolt Monitor Switch – available with 55, 56, 57, 58, AL options	\$256.00
54	Internal Micro Switch in ET Control (not available with 04/10 function)	\$232.00
* 55	Signal Switch in Rail	\$241.00
* 56	Remote Dogging / Latch Retraction (Minimum door width for narrow stile is 26" and wide stile is 28")	\$852.00
* HK56	Latch Retraction with Hex Key Dogging	\$852.00
* 57	Delayed Action (Magnet ordered separate)	\$1,407.00
* 58	Electric Dogging	\$487.00
* 59	Electroguard (Not available with 16-, 53-, 55-, 56-, 57-, 58- Options)	\$1,723.00
* BC59	Electroguard Boca Code (Needs Door Status Switch) (Not available with 16-, 53-, 55-, 56-, 57-, 58- Options)	\$1,829.00
60	SARGENT Large Format Interchangeable Plastic Disposable Construction Core	No addition
63	SARGENT Large Format Interchangeable Core Cylinder includes master and grandmaster keying charge	\$83.00 /cyl.
64	SARGENT Large Format Interchangeable Construction Core Cylinder	\$83.00
6573	Small Format 6 Pin Uncombined Core	\$65.00 / cyl.
65737P	Small Format 7 Pin Uncombined Core	\$65.00 / cyl.
70	Small Format Interchangeable Disposable plastic construction core	No addition
72	Small Format Interchangeable 6-Pin Construction Core (7-pin with 11 option)	\$75.00
73	Small Format 6-pin interchangeable core	\$75.00 / cyl.
737P	Small Format 7-pin interchangeable core	\$75.00 / cyl.
76	Tactile Warning - Milled Outside Lever (Not available with Studio, Coastal and the A Levers)	\$77.00
81	Cylinder to accept Keso (83) and Keso F1 (F183) removable core – no core provided	No addition
F182	SARGENT Keso Security, patent pending, cylinder – new key systems	\$91.00 / cyl.
F183	SARGENT Keso Security, patent pending, removable core cylinder – new key systems	\$130.00 / cyl.
82	SARGENT Keso Security Cylinder (existing key systems only)	\$91.00 / cyl.
83	SARGENT Keso Security Removable Core Cylinder (existing key systems only)	\$130.00 / cyl.
84	SARGENT Keso Security Removable Construction Core Cylinder	See CK-18
85	Tactile Warning - Abrasive Strip Inside Push Rail	\$101.00
86	Tactile Warning - Abrasive Coating Outside Lever	\$47.00
87	Tactile Warning - Abrasive Strip on Inside Push Rail & Coating on Outside Lever	\$148.00
* AL	Alarmed (not available with HC, HC4, 16-, 56- thru 59- options) (minimum Dr width 36")	\$595.00
BR	SARGENT Bump Resistant Cylinders (N/A w/10, 22, 30, 60, 63, 64, 70, 72, 73, 737P, KESO, SC, SE)	\$25.00 /cyl.
CPC	Clear Powder Coat – Recommended for exit devices used in full exterior application and highly corrosive areas with 32 and 32D finishes.	\$232.00
DG1	Patented Degree DG1 Key System	No addition
DG160	Hardware prepared for DG1-6300 Lg. Format IC cores, supplied with temporary plastic construction cores	No addition
DG163	Patented Degree DG1 Large Format Interchangeable Core Cylinder - Includes master keying charges	\$83.00
DG164	Hardware prepared for DG1-6300 Lg. Format IC cores, supplied with temporary keyed construction cores	\$83.00
DG2	Patented Degree DG2 Key System incorporating a locking sidebar	\$63.00/cyl.
DG260	Hardware prepared for DG2-6300 Lg. Format IC cores, supplied with temporary plastic construction cores	No addition
DG263	Patented Degree DG2 Large Format Interchangeable Core Cylinder - Includes master keying charges	\$146.00
DG264	Hardware prepared for DG2-6300 Lg. Format IC cores, supplied with temporary keyed construction cores	\$83.00
DG3	Patented Degree DG3 Key System incorporating a locking sidebar and UL437 listed	\$89.00/cyl.
DG360	Hardware prepared for DG3-6300 Lg. Format IC cores, supplied with temporary plastic construction cores	No addition
DG363	Patented Degree DG3 Large Format Interchangeable Core Cylinder - Includes master keying charges	\$172.00
DG364	Hardware prepared for DG3-6300 Lg. Format IC cores, supplied with temporary keyed construction cores	\$83.00
GL	Guarded Latch (not available with HC or 12-HC)	\$33.00
HC	Hurricane Code (not available with 16, 28, 63, 66 functions)	\$79.00
12HC	UL Fire Label Hurricane Code (not available with 16, 28, 63, 66 functions)	\$263.00
LC	Less Cylinder	-\$96.00/cyl.
LD	Less Dogging	No addition
PL	SARGuide™ PL – Photoluminescent Coating – (Pushbar w/o Lexan Touchpad - 19 option is supplied as standard)	\$376.00
SC	Schlage C Keyway Cylinder 0-Bitted (Rim and #41 Mortise Cylinder Only)	No addition
SE	Schlage E Keyway Cylinder 0-Bitted (Rim and #41 Mortise Cylinder Only)	No addition
SG	MicroShield® an antimicrobial powder coat (not available with 10B)	\$88.00
TB	Thru Bolt	\$24.00
* TL	SARGuide™ – Illuminated Touchpad (not available with AL, 57, 59 options)	\$232.00
WS	Windstorm Certified	No addition 8888 Device and Trims, see pg. ED-37.

* Exact door width required when ordering.

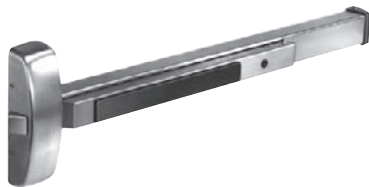
Experience a safer
and more open world

Copyright © 2002-2021 Sargent Manufacturing Company, an ASSA ABLOY Group company. All rights reserved.
Reproduction in whole or in part without the express written permission of Sargent Manufacturing Company is prohibited.
Contact us at: 800-727-5477 or visit www.sargentlock.com. In Canada contact us at: 800-461-3007 or visit www.assaabloydss.ca



8800 Series-Rim Device			
 ET Control Standard Levers: A-B-E-F-J-L-P-W Coastal Levers: G-R-S-Y All Studio Collection Levers (Except Gramercy, Wooster Square, & Grant Park)	 ET Control Gramercy Series: RAG-RAL-RAM-RAS-RCM-REM-RGM Wooster Square: H001-H002-H003-H004-H005-H006 Grant Park: H007-H008-H009-H010-H011	 PTB STS-MAL-FLL-FLW PSB-MSL-FSL-FSW (04 function only)	 Cylinder included on keyed functions. 862, 863, 864 Pull Price includes 862 Pull (shown)
Finishes listed below are for the exit device. Refer to catalog for available trims, trim finishes and how to order.			

Funct. Description	8800 Series							
	Finish							
	10BE/32D/ BSP/WSP	03/04/ 09/10/10B/ 10BL/20D/32	10BE/32D/ BSP/WSP	03/04/ 09/10/10B/ 10BL/20D/32	10BE/32D/ BSP/WSP	03/04/ 09/10/10B/ 10BL/20D/32	10BE/32D/ BSP/WSP	03/04/ 10/10B/ 32
8810 Exit Only – No Trim	\$1,796.00	\$1,906.00						
8810 Dummy Trim (Lever rigid)					\$2,257.00	\$2,367.00	\$2,090.00	\$2,223.00
8804 Key retr. latchbolt (lever rigid)								
8806 Key operates ET	\$2,556.00	\$2,666.00	\$2,799.00	\$2,909.00				
8813 Key locks/unlocks control								
8815 Trim always operable								
8816 Key i/s locks/unlocks lever Key o/s retracts latchbolt	\$2,696.00	\$2,806.00	\$2,939.00	\$3,049.00				
8828 Thumb piece always operable					\$2,338.00	\$2,448.00		
8863 Key locks/unlocks thumb piece								
8866 Key i/s locks/unlocks thumb pc. Key o/s retracts latchbolt					\$2,400.00	\$2,510.00		
8800 Series With Freewheeling Trim								
8840 Dummy Trim (Lever rotates)								
8843 Key engages/disengages lever	\$2,556.00	\$2,666.00	\$2,799.00	\$2,909.00				
8844 Key retr. Itchblt. (Lever rotates)								
8846 Key operates ET								
8800 Series With Electro-Mechanical								
8873 Fail Safe 12v or 24v								
8874 Fail Secure 12v or 24v	\$2,868.00	\$2,978.00	\$3,061.00	\$3,171.00				
8875 Fail Safe 12v or 24v								
8876 Fail Secure 12v or 24v	\$3,125.00	\$3,235.00	\$3,308.00	\$3,418.00				

Note: Specify voltage required when ordering.

863 (18" x 1" Diameter) Pull provided in lieu of 862 (10" x 1" Diameter) Add \$72.00

864 (10" x 3/4" Diameter) Pull provided in lieu of 862 (10" x 1" Diameter) Deduct \$37.00

Thru Bolt Application	Pack Part #				Finish
	No. Bolts per Pack	1-3/4" Dr.	2 1/4" Dr.	03/09/10/10B/10BE/10BL/20D/26D	
8800, 12-8800	4	68-2279	68-2280	\$25.00 Pack	

NOTES:

FLW, FSW not available in 32, 32D.

PSB, MSL, FSL, FSW for use with 8804 function only. Supplied with revised cylinder hole location and thru bolting.

Cylinder not included when ordered less trim except for 04 function.

15 or 26D finishes are available on outside trim only, the exit devices will be supplied in 32D.

14 or 26 Finishes are available on outside trim only, the exit devices will be supplied in 32 finish.

ED-34 EXIT DEVICES

SARGENT®

ASSA ABLOY

8888 (8810) SERIES OPTIONS

USA & Canada Prices Effective May 1, 2021

Exit Options	Description	Price
12	UL Fire Label Exit Devices (not available with 16- option)	\$184.00
16	Cylinder lockdown feature (not available with 12- option)	\$133.00
19	80 Series pushbar without Lexan Touchpad	No addition
43	Flush End Cap	No Addition
CPC	Clear Powder Coat – Recommended for exit devices used in full exterior application and highly corrosive areas with 32 and 32D finishes.	\$232.00
GL	Guarded Latch	\$33.00
LC	Less Cylinder	-\$96.00/cyl.
LD	Less Dogging (non-fire rated exit devices only)	No Addition
PL	SARGuide™ PL – Photoluminescent Coating – (Pushbar w/o Lexan Touchpad - 19 option is supplied as standard) Require handing	\$376.00

Trim Options	Description	Price
10	SARGENT Signature System	\$63.00 / cyl.
11	SARGENT XC Key System (not available w/10, 22, KESO, SC, & SE options)	No addition
1160	SARGENT XC Large Format Interchangeable Plastic Disposable Construction Core	No addition
1163	SARGENT XC Large Format Interchangeable Core Cylinder – Includes masterkeying charges	\$83.00
1164	SARGENT XC Large Format Interchangeable Construction Core Cylinder	\$83.00
1170	Small Format interchangeable disposable construction core - to accept 7 Pin XC permanent core	No addition
11727P	Small Format interchangeable keyed construction core - to accept 7 Pin XC permanent core	\$75.00
11737P	Small Format interchangeable core - to accept 7 pin XC permanent core	\$75.00 / cyl.
21	SARGENT Construction Key System (lost ball)	\$16.00 /cyl.
22	SARGENT Construction Key System (split key)	\$32.00 /cyl.
5CH	5lb. Pressure Release	\$30.00
60	SARGENT Large Format Interchangeable Plastic Disposable Construction Core	No addition
63	SARGENT Large Format Interchangeable Core Cylinder includes master and grandmaster keying charge	\$83.00 /cyl.
64	SARGENT Large Format Interchangeable Construction Core Cylinder	\$83.00
6573	Small Format 6 Pin Uncombined Core	\$65.00 / cyl.
65737P	Small Format 7 Pin Uncombined Core	\$65.00 / cyl.
70	Small Format Interchangeable Disposable plastic core	No addition
72	Small Format Interchangeable Cores 6-Pin Construction Core provided (7-pin with 11 option)	\$75.00
73	Small Format 6-pin interchangeable core	\$75.00 / cyl.
737P	Small Format 7-pin interchangeable core	\$75.00 / cyl.
BR	SARGENT Bump Resistant Cylinders (N/A w/10, 22, 30, 60, 63, 64, 70, 72, 73, 737P, KESO, SC, SE)	\$25.00 /cyl.
CPC	Clear Powder Coat – Recommended for exit devices used in full exterior application and highly corrosive areas with 32 and 32D finishes.	\$232.00
LC	Less Cylinder	-\$96.00/cyl.
SC	Schlage C Keyway Cylinder 0-Bitted (Rim and #41 Mortise Cylinder Only)	No Addition
SE	Schlage E Keyway Cylinder 0-Bitted (Rim and #41 Mortise Cylinder Only)	No Addition
SF	L Lever to accept Schlage Large Format Interchangeable Core (supplied less core, tailpiece included)	No Addition
SG	MicroShield® an antimicrobial powder coat (not available with 10B)	\$88.00
TB	Thru Bolt	\$24.00

Notes:

80 Series 700-ET, 88-LL, LB, LJ, LP Trims Not Available in Stainless Steel.

Experience a safer
and more open world

Copyright © 2002-2021 Sargent Manufacturing Company, an ASSA ABLOY Group company. All rights reserved. Reproduction in whole or in part without the express written permission of Sargent Manufacturing Company is prohibited. Contact us at: 800-727-5477 or visit www.sargentlock.com. In Canada contact us at: 800-461-3007 or visit www.assaabloydss.ca

8888 REVERSIBLE RIM EXIT DEVICE

USA & Canada Prices Effective May 1, 2021

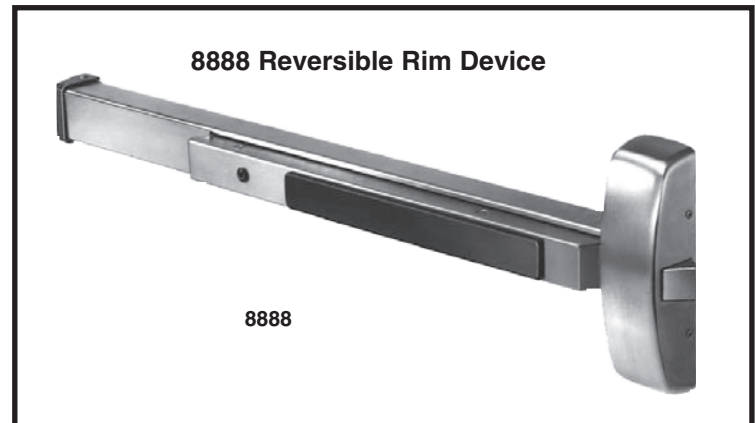

Device	Finish	
	10BE/32D/BSP/WSP	03/04/09/10/10B/ 10BL/20D/32
8888	\$1,796.00	\$1,906.00

8888 Series Trim			
Function	Trim	Description	*All Finishes
704	- Standard Levers (A, B, E, F, J, L, P, W)	Key retracts latchbolt (Lever rigid)	
710	- Coastal Levers (C, G, R, S, Y)	Dummy Trim (Lever rigid)	\$760.00
713-8	- All Studio Collection levers except Gramercy, Wooster Square, and Grant Park	Key locks/unlocks lever control	
715-8		Trim always operable	
704	- Gramercy Levers: RAG-RAL-RAM-RAS-RCM-REM-RGM	Key retracts latchbolt (Lever rigid)	
710	- Wooster Sq. Levers: H001-H002-H003-H004-	Dummy Trim (Lever rigid)	\$1,003.00
713-8	H005-H006	Key locks/unlocks lever control	
715-8	- Grant Park Levers: H007-H008-H009-H010-H011	Trim always operable	
*88C	Key locks/unlocks trim	LL, LB, LJ, LP	
*88D	Dummy Trim	LL, LB, LJ, LP	\$572.00
*88K	Key retracts latchbolt	LL, LB, LJ, LP	
*88L	Trim always operable	LL, LB, LJ, LP	
68-0657	Prep Cover Plate/fits under ET trim (old # 88-E-PTB)		\$180.00
810	Dummy Trim	PTB, STS	
814	Key retracts latchbolt (04 function)	PSB, MSL, FSL, FSW*	\$461.00
814	Key retracts latchbolt	STS	

8888 Series With Freewheeling Trim			
Function	Trim	Description	*All Finishes
740	- Standard Levers (A, B, E, F, J, L, P, W)	Dummy Trim (lever rotates)	
743-8	- Coastal Levers (C, G, R, S, Y), and All Studio Collection levers except Gramercy, Wooster Square, & Grant Park	Key engages/disengages lever	\$760.00
744		Key retracts latchbolt (lever rotates)	
740	- Gramercy Levers: RAG-RAL-RAM-RAS-RCM-REM-RGM	Dummy Trim (lever rotates)	
743-8	- Wooster Sq. Levers: H001-H002-H003-H004-H005-H006	Key engages/disengages lever	\$1,003.00
744	- Grant Park Levers: H007-H008-H009-H010-H011	Key retracts latchbolt (lever rotates)	

Note: Refer to catalog for available trims, trim finishes and how to order.

*FSW, 88C, 88K, 88L, 88D, & ET's not available in 32, 32D.

8900 SERIES OPTIONS

USA & Canada Prices Effective May 1, 2021

Options	Description	Price
10	SARGENT Signature System	\$63.00 / cyl.
11	SARGENT XC Key System (not available w/10, 22, KESO, SC, & SE options)	No addition
1160	SARGENT XC Large Format Interchangeable Plastic Disposable Construction Core	No addition
1163	SARGENT XC Large Format Interchangeable Core Cylinder – Includes masterkeying charges	\$83.00
1164	SARGENT XC Large Format Interchangeable Construction Core Cylinder	\$83.00
1170	Small Format interchangeable disposable construction core - to accept 7 Pin XC permanent core	No addition
11727P	Small Format interchangeable keyed construction core - to accept 7 Pin XC permanent core	\$75.00
11737P	Small Format interchangeable core - to accept 7 pin XC permanent core	\$75.00 / cyl.
12	UL Fire Label Exit Devices (not available with 16- & HK options)	\$184.00
16	Cylinder lockdown feature in rail (not available with 12-, 57-, 59-, AL- options)	\$133.00
19	80 Series pushbar without Lexan touchpad	No addition
21	SARGENT Construction Key System (lost ball)	\$16.00 /cyl.
22	SARGENT Construction Key System (split key)	\$32.00 /cyl.
23	ANSI flat lip strike (8300, 8900, 9900, Including 12-Option)	No addition
31	For doors greater than 1-3/4" and up to 2-1/4" (including those with auxiliary controls)	No addition
	For doors over 2-1/4"	Consult Factory
	For doors with panels (See catalog for ordering details)	No addition
36	6 Lobe security head screws	\$56.00
37	Spanner head screws	\$36.00
43	Flush End Cap	No addition
* 53	Latchbolt Monitor Switch – available with 55, 56, 57, 58, AL options	\$256.00
54	Internal Micro Switch in ET Control (not available with 04/10 function)	\$232.00
* 55	Signal Switch in Rail	\$241.00
* 56	Remote Dogging / Latch Retraction (Minimum door width for narrow stile is 26" and wide stile is 28")	\$852.00
* HK56	Latch Retraction with Hex Key Dogging	\$852.00
* 57	Delayed Action (Magnet ordered separate)	\$1,407.00
* 58	Electric Dogging	\$487.00
* 59	Electroguard (Not available with 16-, 53-, 55-, 56-, 57-, 58- Options)	\$1,723.00
* BC59	Electroguard Boca Code (Needs Door Status Switch) (Not available with 16-, 53-, 55-, 56-, 57-, 58- Options)	\$1,829.00
60	SARGENT Large Format Interchangeable Plastic Disposable Construction Core	No addition
63	SARGENT Large Format Interchangeable Core Cylinder includes master and grandmaster keying charge	\$83.00 /cyl.
64	SARGENT Large Format Interchangeable Construction Core Cylinder	\$83.00
6573	Small Format 6 Pin Uncombined Core	\$65.00 / cyl.
65737P	Small Format 7 Pin Uncombined Core	\$65.00 / cyl.
70	Small Format Interchangeable Disposable plastic construction core	No addition
72	Small Format Interchangeable 6-Pin Construction Core (7-pin with 11 option)	\$75.00
73	Small Format 6-pin interchangeable core	\$75.00 / cyl.
737P	Small Format 7-pin interchangeable core	\$75.00 / cyl.
76	Tactile Warning - Milled Outside Lever (Not available with Studio, Coastal and the A Levers)	\$77.00
81	Cylinder to accept Keso (83) and Keso F1 (F183) removable core – no core provided	No addition
F182	SARGENT Keso Security, patent pending, cylinder – new key systems	\$91.00 / cyl.
F183	SARGENT Keso Security, patent pending, removable core cylinder – new key systems	\$130.00 / cyl.
82	SARGENT Keso Security Cylinder (existing key systems only)	\$91.00 / cyl.
83	SARGENT Keso Security Removable Core Cylinder (existing key systems only)	\$130.00 / cyl.
84	SARGENT Keso Security Removable Construction Core Cylinder	See CK-18
85	Tactile Warning - Abrasive Strip Inside Push Rail	\$101.00
86	Tactile Warning - Abrasive Coating Outside Lever	\$47.00
87	Tactile Warning - Abrasive Strip on Inside Push Rail & Coating on Outside Lever	\$148.00
* AL	Alarmed (not available with HC, HC4, 16-, 56- thru 59- options) (minimum Dr width 36")	\$595.00
BR	SARGENT Bump Resistant Cylinders (N/A w/10, 22, 30, 60, 63, 64, 70, 72, 73, 737P, KESO, SC, SE)	\$25.00 /cyl.
CPC	Clear Powder Coat – Recommended for exit devices used in full exterior application and highly corrosive areas with 32 and 32D finishes.	\$232.00
DG1	Patented Degree DG1 Key System	No addition
DG160	Hardware prepared for DG1-6300 Lg. Format IC cores, supplied with temporary plastic construction cores	No addition
DG163	Patented Degree DG1 Large Format Interchangeable Core Cylinder - Includes master keying charges	\$83.00
DG164	Hardware prepared for DG1-6300 Lg. Format IC cores, supplied with temporary keyed construction cores	\$83.00
DG2	Patented Degree DG2 Key System incorporating a locking sidebar	\$63.00/cyl.
DG260	Hardware prepared for DG2-6300 Lg. Format IC cores, supplied with temporary plastic construction cores	No addition
DG263	Patented Degree DG2 Large Format Interchangeable Core Cylinder - Includes master keying charges	\$146.00
DG264	Hardware prepared for DG2-6300 Lg. Format IC cores, supplied with temporary keyed construction cores	\$83.00
DG3	Patented Degree DG3 Key System incorporating a locking sidebar and UL437 listed	\$89.00/cyl.
DG360	Hardware prepared for DG3-6300 Lg. Format IC cores, supplied with temporary plastic construction cores	No addition
DG363	Patented Degree DG3 Large Format Interchangeable Core Cylinder - Includes master keying charges	\$172.00
DG364	Hardware prepared for DG3-6300 Lg. Format IC cores, supplied with temporary keyed construction cores	\$83.00
LC	Less Cylinder	-\$96.00/cyl.
LD	Less Dogging	No addition
PL	SARGuide™ PL – Photoluminescent Coating – (Pushbar w/o Lexan Touchpad - 19 option is supplied as standard)	\$376.00
SC	Schlage C Keyway Cylinder 0-Bitted (Rim and #41 Mortise Cylinder Only)	No addition
SE	Schlage E Keyway Cylinder 0-Bitted (Rim and #41 Mortise Cylinder Only)	No addition
SG	MicroShield® an antimicrobial powder coat (not available with 10B)	\$88.00
* TL	SARGuide™ – Illuminated Touchpad (not available with AL, 57, 59 options)	\$232.00
TB	Thru Bolt	\$24.00
WS	Windstorm Certified	No addition

* Exact door width required when ordering.



8900 Series-Mortise Device		
 ET Control	 ET Control	 PTB STS-MAL-FLL-FLW
Standard Levers: A-B-E-F-J-L-P-W Coastal Levers: G-R-S-Y All Studio Collection Levers (Except Gramercy, Wooster Square, & Grant Park)	Gramercy Series: RAG-RAL-RAM-RAS- RCM-REM-RGM Wooster Square: H001-H002-H003-H004- H005-H006 Grant Park: H007-H008-H009-H010-H011	
Finishes listed below are for the exit device. Refer to catalog for available trims, trim finishes and how to order.		

8900 Series		Finish					
Funct.	Description	10BE/32D/ BSP/WSP	03/04/09/10/10B/ 10BL/20D/32	10BE/32D/ BSP/WSP	03/04/09/10/10B/ 10BL/20D/32	10BE/32D/ BSP/WSP	03/04/09/10/10B/ 10BL/20D/32
8910	Exit Only - No Trim	\$2,528.00	\$2,695.00				
8910	Dummy Trim (Lever rigid)					\$2,989.00	\$3,156.00
8904	Key retracts latchbolt (Lever rigid) *						
8906	Key operates ET	\$3,288.00	\$3,455.00	\$3,531.00	\$3,698.00		
8913	Key locks/unlocks control						
8915	Trim always operable						
8916	Key inside locks/unlocks lever	\$3,412.00 *	\$3,579.00 *	\$3,655.00 *	\$3,822.00 *		
8928	Thumb pc. always operable					\$3,058.00	\$3,225.00
8963	Key locks/unlocks thumb pc.						
8966	Key inside locks/unlocks thumb pc.					\$3,120.00 *	\$3,287.00 *
8900 Series With Freewheeling Trim							
8940	Dummy Trim (Lever rotates)						
8943	Key engages/disengages lever						
8944	Key retracts latchbolt (Lever rotates) *	\$3,288.00	\$3,455.00	\$3,531.00	\$3,698.00		
8946	Key operates ET						
8900 Series With Electro-Mechanical							
8973	Fail Safe 12v or 24v	\$3,600.00	\$3,767.00	\$3,793.00	\$3,960.00		
8974	Fail Secure 12v or 24v						
8975	Fail Safe 12v or 24v	\$3,857.00 *	\$4,024.00 *	\$4,040.00 *	\$4,207.00 *		
8976	Fail Secure 12v or 24v						

Note: Specify voltage required when ordering.

Thru Bolt Application	Pack Part #			Finish
	No. Bolts per pack	1-3/4" Dr.	2-1/4" Dr.	
8900	4	68-2279	68-2280	\$25.00 Pack

NOTES: Cylinder not included when ordered less trim except for 04 function.
 *Not available with Arrow, Best, Falcon Interchangeable Core Options, SC + SE Cylinders.

15 or 26D finishes are available on outside trim only, the exit devices will be supplied in 32D.

14 or 26 Finishes are available on outside trim only, the exit devices will be supplied in 32 finish.

ED-38 EXIT DEVICES

SARGENT®

ASSA ABLOY

9400 SERIES OPTIONS

USA & Canada Prices Effective May 1, 2021

Options	Description	Price
10	SARGENT Signature System	\$63.00 / cyl.
11	SARGENT XC Key System (not available w/10, 22, KESO, SC, & SE options)	No addition
12	UL Fire Label Exit Devices	\$184.00
21	SARGENT Construction Key System (lost ball)	\$16.00 /cyl.
22	SARGENT Construction Key System (split key)	\$32.00 /cyl.
85	Tactile Warning - Abrasive Strip Inside Push Rail	\$101.00
BR	SARGENT Bump Resistant Cylinders (N/A w/10, 22, 30, 60, 63, 64, 70, 72, 73, 737P, KESO, SC, SE)	\$25.00 /cyl.
LC	Less Cylinder	-\$96.00/cyl.
SC	Schlage C Keyway Cylinder 0-Bitted (Rim and #41 Mortise Cylinder Only)	No addition
SE	Schlage E Keyway Cylinder 0-Bitted (Rim and #41 Mortise Cylinder Only)	No addition

Experience a safer
and more open world

Copyright © 2002-2021 Sargent Manufacturing Company, an ASSA ABLOY Group company. All rights reserved.
Reproduction in whole or in part without the express written permission of Sargent Manufacturing Company is prohibited.
Contact us at: 800-727-5477 or visit www.sargentlock.com. In Canada contact us at: 800-461-3007 or visit www.assaabloydss.ca

9400 Series – Narrow Stile Concealed Vertical Rod



9400 Series		Finish		
Function	Description	10BE/26D/BSP/WSP	03/04/10/15	09/10B/26/32/32D
9410	Exit Only	\$3,646.00	\$3,754.00	\$3,947.00
9404	Key retracts latchbolt	\$3,962.00	\$4,045.00	\$4,242.00

ED-40 EXIT DEVICES

SARGENT®

ASSA ABLOY

9700 EXIT OPTIONS

USA & Canada Prices Effective May 1, 2021

Options	Description	Price
10	SARGENT Signature System	\$63.00 / cyl.
11	SARGENT XC Key System (not available w/10, 22, KESO, SC, & SE options)	No addition
1160	SARGENT XC Large Format Interchangeable Plastic Disposable Construction Core	No addition
1163	SARGENT XC Large Format Interchangeable Core Cylinder – Includes masterkeying charges	\$83.00
1164	SARGENT XC Large Format Interchangeable Construction Core Cylinder	\$83.00
1170	Small Format interchangeable disposable construction core - to accept 7 Pin XC permanent core	No addition
11727P	Small Format interchangeable keyed construction core - to accept 7 Pin XC permanent core	\$75.00
11737P	Small Format interchangeable core - to accept 7 pin XC permanent core	\$75.00 / cyl.
12	UL Fire Label Exit Devices	\$184.00
14	Sliding bolt bottom case for 9700 Series	No addition
21	SARGENT Construction Key System (lost ball)	\$16.00 / cyl.
22	SARGENT Construction Key System (split key)	\$32.00 / cyl.
31	For doors greater than 1-3/4" and up to 2-1/4" (including those with auxiliary controls)	No addition
	For doors over 2-1/4"	Consult Factory
	For doors with panels	Consult Factory
36	6 Lobe security head screws	\$105.00
37	Spanner head screws	\$70.00
42	Reinforced Crossbar	\$77.00
54	Internal Micro Switch in ET Control	\$232.00
60	SARGENT Large Format Interchangeable Plastic Disposable Construction Core	No addition
63	SARGENT Large Format Interchangeable Core Cylinder includes master and grandmaster keying charge	\$83.00 / cyl.
64	SARGENT Large Format Interchangeable Construction Core Cylinder	\$83.00
6573	Small Format 6 Pin Uncombined Core	\$65.00 / cyl.
65737P	Small Format 7 Pin Uncombined Core	\$65.00 / cyl.
70	Small Format Interchangeable Disposable plastic core	No addition
72	Small Format Interchangeable Cores 6-Pin Construction Core provided (7-pin with 11 Option)	\$75.00
73	Small Format 6-pin interchangeable core	\$75.00 / cyl.
737P	Small Format 7-pin interchangeable core	\$75.00 / cyl.
76	Tactile Warning - Milled Outside Lever (Not available with Studio, Coastal and the A Levers)	\$77.00
81	Cylinder to accept Keso (83) and Keso F1 (F183) removable core – no core provided	No addition
F182	SARGENT Keso Security, patent pending, cylinder – new key systems	\$91.00 / cyl.
F183	SARGENT Keso Security, patent pending, removable core cylinder – new key systems	\$130.00 / cyl.
82	SARGENT Keso Security Cylinder (existing key systems only)	\$91.00 / cyl.
83	SARGENT Keso Security Removable Core Cylinder (existing key systems only)	\$130.00 / cyl.
84	SARGENT Keso Security Removable Construction Core Cylinder	See CK-18
85	Tactile Warning - Abrasive Strip Inside Push Rail	\$101.00
86	Tactile Warning - Abrasive Coating Outside Lever	\$47.00
87	Tactile Warning - Abrasive Strip on Inside Push Rail & Coating on Outside Lever	\$148.00
BR	SARGENT Bump Resistant Cylinders (N/A w/10, 22, 30, 60, 63, 64, 70, 72, 73, 737P, KESO, SC, SE)	\$25.00 / cyl.
CPC	Clear Powder Coat – Recommended for exit devices used in full exterior application and highly corrosive areas with 32 and 32D finishes.	\$232.00
DG1	Patented Degree DG1 Key System	No addition
DG160	Hardware prepared for DG1-6300 Lg. Format IC cores, supplied with temporary plastic construction cores	No addition
DG163	Patented Degree DG1 Large Format Interchangeable Core Cylinder - Includes master keying charges	\$83.00
DG164	Hardware prepared for DG1-6300 Lg. Format IC cores, supplied with temporary keyed construction cores	\$83.00
DG2	Patented Degree DG2 Key System incorporating a locking sidebar	\$63.00/cyl.
DG260	Hardware prepared for DG2-6300 Lg. Format IC cores, supplied with temporary plastic construction cores	No addition
DG263	Patented Degree DG2 Large Format Interchangeable Core Cylinder - Includes master keying charges	\$146.00
DG264	Hardware prepared for DG2-6300 Lg. Format IC cores, supplied with temporary keyed construction cores	\$83.00
DG3	Patented Degree DG3 Key System incorporating a locking sidebar and UL437 listed	\$89.00/cyl.
DG360	Hardware prepared for DG3-6300 Lg. Format IC cores, supplied with temporary plastic construction cores	No addition
DG363	Patented Degree DG3 Large Format Interchangeable Core Cylinder - Includes master keying charges	\$172.00
DG364	Hardware prepared for DG3-6300 Lg. Format IC cores, supplied with temporary keyed construction cores	\$83.00
LC	Less Cylinder	-\$96.00/cyl.
SC	Schlage C Keyway Cylinder 0-Bitted (Rim and #41 Mortise Cylinder Only)	No addition
SE	Schlage E Keyway Cylinder 0-Bitted (Rim and #41 Mortise Cylinder Only)	No addition
SG	MicroShield® an antimicrobial powder coat (not available with 10B)	\$88.00
TB	Thru Bolt	\$84.00

Vertical Rod Device to 96" Height

No addition

Concealed/Surface Vertical Rod Device over 96" to 120" Height

\$64.00

Center Bearing Bracket for door 48" and over, order using part 98-2162 x finish

\$433.00

Refer to catalog for max. door height availability on fire rated exit devices.

Experience a safer
and more open world





Copyright © 2002-2021 Sargent Manufacturing Company, an ASSA ABLOY Group company. All rights reserved.
Reproduction in whole or in part without the express written permission of Sargent Manufacturing Company is prohibited.
Contact us at: 800-727-5477 or visit www.sargentlock.com. In Canada contact us at: 800-461-3007 or visit www.assaabloydss.ca

ED-41 EXIT DEVICES

9700 SERIES

USA & Canada Prices Effective May 1, 2021



9700 Series-Surface Vertical Rod Device			
ET Control 	ET Control 	 PTB STS-MAL-FLL-FLW	  Auxiliary Control with (306/313) 862, 863 864 Pull Price includes 862 Pull (shown)
Standard Levers: A-B-E-F-J-L-P-W Coastal Levers: G-R-S-Y All Studio Collection Levers (Except Gramercy, Wooster Square, & Grant Park)	Gramercy Series: RAG-RAL-RAM-RAS-RCM-REM-RGM Wooster Square: H001-H002-H003-H004-H005-H006 Grant Park: H007-H008-H009-H010-H011		
Finishes listed below are for the exit device. Refer to catalog for available trims, trim finishes and how to order.			

9700 Series	Funct. Description	Finish							
		03/04/		03/04/		03/04/		03/04/	
		10BE/32D/ BSP/WSP	09/10/10B/ 10BL/20D/32	10BE/32D/ BSP/WSP	09/10/10B/ 10BL/20D/32	10BE/32D/ BSP/WSP	09/10/10B/ 10BL/20D/32	10BE/32D/ BSP/WSP	10/10B/ 32
9710	Exit Only - No Trim	\$2,734.00	\$3,402.00						
9710	Dummy Trim	\$3,494.00	\$4,162.00	\$3,737.00	\$4,405.00	\$3,195.00	\$3,863.00	\$3,028.00	\$3,719.00
*9710	Key Operates Control							\$3,788.00	\$4,479.00
9706	Key operates ET								
9713	Key locks/unlocks ET	\$3,494.00	\$4,162.00	\$3,737.00	\$4,405.00				
9715	Trim always operable								
9728	Thumb piece always operable					\$3,266.00	\$3,934.00		
9763	Key locks/unlocks thumb piece								

*When ordering Exits with Auxiliary Control Design, please order as follows: example: 9710 x 306/313 x 862 x 32D x RHR

9700 Series With Electro-Mechanical									
9773	Fail Safe 12v or 24v	\$3,806.00	\$4,474.00	\$3,999.00	\$4,667.00				
9774	Fail Secure 12v or 24v								

Note: Specify voltage required when ordering.

863 (18" x 1" Diameter) Pull provided in lieu of 862 (10" x 1" Diameter)

Add \$72.00

864 (10" x 3/4" Diameter) Pull provided in lieu of 862 (10" x 1" Diameter)

Deduct \$37.00

Thru Bolt Application	No. Bolts per pack	Pack Part #		Finish
		1-3/4" Dr.	03/09/10/10B/10BE/10BL/20D/26D/BSP/WSP	
9700	14	97-2579		\$82.00 Pack
12-9700	16	97-2965		\$92.00 Pack

NOTES:

15 or 26D finishes are available on outside trim only, the exit devices will be supplied in 32D.

14 or 26 Finishes are available on outside trim only, the exit devices will be supplied in 32 finish.

Cylinders not included when ordered less trim.

▶ Dummy Trim includes Pull only, Auxiliary Control not supplied.

9800 SERIES OPTIONS

USA & Canada Prices Effective May 1, 2021

Options	Description	Price
10	SARGENT Signature System	\$63.00 / cyl.
11	SARGENT XC Key System (not available w/10, 22, KESO, SC, & SE options)	No addition
1160	SARGENT XC Large Format Interchangeable Plastic Disposable Construction Core	No addition
1163	SARGENT XC Large Format Interchangeable Core Cylinder – Includes masterkeying charges	\$83.00
1164	SARGENT XC Large Format Interchangeable Construction Core Cylinder	\$83.00
1170	Small Format interchangeable disposable construction core - to accept 7 Pin XC permanent core	No addition
11727P	Small Format interchangeable keyed construction core - to accept 7 Pin XC permanent core	\$75.00
11737P	Small Format interchangeable core - to accept 7 pin XC permanent core	\$75.00 / cyl.
12	UL Fire Label Exit Devices	\$184.00
21	SARGENT Construction Key System (lost ball)	\$16.00 / cyl.
22	SARGENT Construction Key System (split key)	\$32.00 / cyl.
31	For doors up to 2-1/4"	No addition
	For doors over 2-1/4"	Consult Factory
	For doors with panels	Consult Factory
36	6 Lobe security head screws	\$46.00
37	Spanner head screws	\$29.00
42	Reinforced Crossbar	\$77.00
54	Internal Micro Switch in ET Control	\$232.00
60	SARGENT Large Format Interchangeable Plastic Disposable Construction Core	No addition
63	SARGENT Large Format Interchangeable Core Cylinder includes master and grandmaster keying charge	\$83.00 /cyl.
64	SARGENT Large Format Interchangeable Construction Core Cylinder	\$83.00
6573	Small Format 6 Pin Uncombined Core	\$65.00 / cyl.
65737P	Small Format 7 Pin Uncombined Core	\$65.00 / cyl.
70	Small Format Interchangeable Disposable plastic construction core	No addition
72	Small Format Interchangeable 6-Pin construction core (7-pin with 11 option)	\$75.00
73	Small Format 6-pin interchangeable core	\$75.00 / cyl.
737P	Small Format 7-pin interchangeable core	\$75.00 / cyl.
76	Tactile Warning - Milled Outside Lever (Not available with Studio, Coastal and the A Levers)	\$77.00
81	Cylinder to accept Keso (83) and Keso F1 (F183) removable core – no core provided	No addition
F182	SARGENT Keso Security, patent pending, cylinder – new key systems	\$91.00 / cyl.
F183	SARGENT Keso Security, patent pending, removable core cylinder – new key systems	\$130.00 / cyl.
82	SARGENT Keso Security Cylinder (existing key systems only)	\$91.00 / cyl.
83	SARGENT Keso Security Removable Core Cylinder (existing key systems only)	\$130.00 / cyl.
84	SARGENT Keso Security Removable Construction Core Cylinder	See CK-18
85	Tactile Warning - Abrasive Strip Inside Push Rail	\$101.00
86	Tactile Warning - Abrasive Coating Outside Lever	\$47.00
87	Tactile Warning - Abrasive Strip on Inside Push Rail & Coating on Outside Lever	\$148.00
BR	SARGENT Bump Resistant Cylinders (N/A w/10, 22, 30, 60, 63, 64, 70, 72, 73, 737P, KESO, SC, SE)	\$25.00 /cyl.
CPC	Clear Powder Coat – Recommended for exit devices used in full exterior application and highly corrosive areas with 32 and 32D finishes.	\$232.00
DG1	Patented Degree DG1 Key System	No addition
DG160	Hardware prepared for DG1-6300 Lg. Format IC cores, supplied with temporary plastic construction cores	No addition
DG163	Patented Degree DG1 Large Format Interchangeable Core Cylinder - Includes master keying charges	\$83.00
DG164	Hardware prepared for DG1-6300 Lg. Format IC cores, supplied with temporary keyed construction cores	\$83.00
DG2	Patented Degree DG2 Key System incorporating a locking sidebar	\$63.00/cyl.
DG260	Hardware prepared for DG2-6300 Lg. Format IC cores, supplied with temporary plastic construction cores	No addition
DG263	Patented Degree DG2 Large Format Interchangeable Core Cylinder - Includes master keying charges	\$146.00
DG264	Hardware prepared for DG2-6300 Lg. Format IC cores, supplied with temporary keyed construction cores	\$83.00
DG3	Patented Degree DG3 Key System incorporating a locking sidebar and UL437 listed	\$89.00/cyl.
DG360	Hardware prepared for DG3-6300 Lg. Format IC cores, supplied with temporary plastic construction cores	No addition
DG363	Patented Degree DG3 Large Format Interchangeable Core Cylinder - Includes master keying charges	\$172.00
DG364	Hardware prepared for DG3-6300 Lg. Format IC cores, supplied with temporary keyed construction cores	\$83.00
LC	Less Cylinder	-\$96.00/cyl.
SC	Schlage C Keyway Cylinder 0-Bitted (Rim and #41 Mortise Cylinder Only)	No addition
SE	Schlage E Keyway Cylinder 0-Bitted (Rim and #41 Mortise Cylinder Only)	No addition
SG	MicroShield® an antimicrobial powder coat (not available with 10B)	\$88.00
TB	Thru Bolt	\$24.00



9898 Device and Trims see page ED-7.

Center Bearing Bracket for door 48" and over, order using part 98-2162 x finish

\$433.00

**** Not available with Studio Collection lever designs.**



9800 Series-Rim Device		
ET Control 	ET Control 	
Standard Levers: A-B-E-F-J-L-P-W Coastal Levers: G-R-S-Y All Studio Collection Levers (Except Gramercy, Wooster Square, & Grant Park)	Gramercy Series: RAG-RAL-FAM-RAS-RCM-REM-RGM Wooster Square: H001-H002-H003-H004-H005-H006 Grant Park: H007-H008-H009-H010-H011	PTB STS-MAL-FLL-FLW
Finishes listed below are for the exit device. Refer to catalog for available trims, trim finishes and how to order.		

9800 Series		Finish					
Funct.	Description	10BE/32D/ BSP/WSP	03/04/09/10/10B/ 10BL/20D/32	10BE/32D/ BSP/WSP	03/04/09/10/10B/ 10BL/20D/32	10BE/32D/ BSP/WSP	03/04/09/10/10B/ 10BL/20D/32
9810	Exit Only No Trim	\$2,005.00	\$2,570.00				
9810	Dummy Trim					\$2,466.00	\$3,031.00
9804	Key retracts latchbolt	\$2,765.00	\$3,330.00	\$3,008.00	\$3,573.00		
9813	Key locks/unlocks control						
9815	Trim always operable						
9828	Thumb pc. always operable					\$2,537.00	\$3,102.00
9863	Key locks/unlocks thumb pc.						
9800 Series With Electro-Mechanical							
9873*	Fail Safe 12v or 24v	\$3,077.00	\$3,642.00	\$3,270.00	\$3,835.00		
9874*	Fail Secure 12v or 24v						
9875*	Fail Safe 12v or 24v	\$3,334.00	\$3,899.00	\$3,517.00	\$4,082.00		
9876*	Fail Secure 12v or 24v						

Note: Specify voltage required when ordering.

Thru Bolt Application	No. Bolts per pack	Pack Part #	Finish
9800, 12-9800	4	1-3/4" Dr. 97-2578	03/09/10/10B/10BE/10BL/20D/26D/BSP/WSP \$25.00 Pack

*9875, *9876 function is not available in 12- option

Cylinder not included when ordered less trim except for 04 function.

NOTES:

15 or 26D finishes are available on outside trim only, the exit devices will be supplied in 32D.

14 or 26 Finishes are available on outside trim only, the exit devices will be supplied in 32 finish.

ED-44 EXIT DEVICES

SARGENT®

ASSA ABLOY

9900 SERIES OPTIONS

USA & Canada Prices Effective May 1, 2021

Options	Description	Price
10	SARGENT Signature System	\$63.00 / cyl.
11	SARGENT XC Key System (not available w/10, 22, KESO, SC, & SE options)	No addition
1160	SARGENT XC Large Format Interchangeable Plastic Disposable Construction Core	No addition
1163	SARGENT XC Large Format Interchangeable Core Cylinder – Includes masterkeying charges	\$83.00
1164	SARGENT XC Large Format Interchangeable Construction Core Cylinder	\$83.00
1170	Small Format interchangeable disposable construction core - to accept 7 Pin XC permanent core	No addition
11727P	Small Format interchangeable keyed construction core - to accept 7 Pin XC permanent core	\$75.00
11737P	Small Format interchangeable core - to accept 7 pin XC permanent core	\$75.00 / cyl.
12	UL Fire Label Exit Devices	\$184.00
21	SARGENT Construction Key System (lost ball)	\$16.00 / cyl.
22	SARGENT Construction Key System (split key)	\$32.00 / cyl.
23	ANSI Flat Lip Strike (8300, 8900, 9900 including 12- option)	No addition
31	For doors up to 2-1/4"	No addition
	For doors over 2-1/4"	Consult Factory
	For doors with panels	Consult Factory
36	6 Lobe security head screws	\$52.00
37	Spanner head screws	\$33.00
42	Reinforced Crossbar	\$77.00
54	Internal Micro Switch in ET Control	\$232.00
60	SARGENT Large Format Interchangeable Plastic Disposable Construction Core	No addition
63	SARGENT Large Format Interchangeable Core Cylinder includes master and grandmaster keying charge	\$83.00 /cyl.
64	SARGENT Large Format Interchangeable Construction Core Cylinder	\$83.00
6573	Small Format 6 Pin Uncombined Core	\$65.00 / cyl.
65737P	Small Format 7 Pin Uncombined Core	\$65.00 / cyl.
70	Small Format Interchangeable Disposable plastic Construction Core	No addition
72	Small Format Interchangeable 6-Pin Construction Core (7-pin with 11 option)	\$75.00
73	Small Format 6-pin interchangeable core	\$75.00 / cyl.
737P	Small Format 7-pin interchangeable core	\$75.00 / cyl.
76	Tactile Warning - Milled Outside Lever (Not available with Studio, Coastal and the A Levers)	\$77.00
81	Cylinder to accept Keso (83) and Keso F1 (F183) removable core – no core provided	No addition
F182	SARGENT Keso Security, patent pending, cylinder – new key systems	\$91.00 / cyl.
F183	SARGENT Keso Security, patent pending, removable core cylinder – new key systems	\$130.00 / cyl.
82	SARGENT Keso Security Cylinder (existing key systems only)	\$91.00 / cyl.
83	SARGENT Keso Security Removable Core Cylinder (existing key systems only)	\$130.00 / cyl.
84	SARGENT Keso Security Removable Construction Core Cylinder	See CK-18
85	Tactile Warning - Abrasive Strip Inside Push Rail	\$101.00
86	Tactile Warning - Abrasive Coating Outside Lever	\$47.00
87	Tactile Warning - Abrasive Strip on Inside Push Rail & Coating on Outside Lever	\$148.00
BR	SARGENT Bump Resistant Cylinders (N/A w/10, 22, 30, 60, 63, 64, 70, 72, 73, 737P, KESO, SC, SE)	\$25.00 /cyl.
CPC	Clear Powder Coat – Recommended for exit devices used in full exterior application and highly corrosive areas with 32 and 32D finishes.	\$232.00
DG1	Patented Degree DG1 Key System	No addition
DG160	Hardware prepared for DG1-6300 Lg. Format IC cores, supplied with temporary plastic construction cores	No addition
DG163	Patented Degree DG1 Large Format Interchangeable Core Cylinder - Includes master keying charges	\$83.00
DG164	Hardware prepared for DG1-6300 Lg. Format IC cores, supplied with temporary keyed construction cores	\$83.00
DG2	Patented Degree DG2 Key System incorporating a locking sidebar	\$63.00/cyl.
DG260	Hardware prepared for DG2-6300 Lg. Format IC cores, supplied with temporary plastic construction cores	No addition
DG263	Patented Degree DG2 Large Format Interchangeable Core Cylinder - Includes master keying charges	\$146.00
DG264	Hardware prepared for DG2-6300 Lg. Format IC cores, supplied with temporary keyed construction cores	\$83.00
DG3	Patented Degree DG3 Key System incorporating a locking sidebar and UL437 listed	\$89.00/cyl.
DG360	Hardware prepared for DG3-6300 Lg. Format IC cores, supplied with temporary plastic construction cores	No addition
DG363	Patented Degree DG3 Large Format Interchangeable Core Cylinder - Includes master keying charges	\$172.00
DG364	Hardware prepared for DG3-6300 Lg. Format IC cores, supplied with temporary keyed construction cores	\$83.00
LC	Less Cylinder	-\$96.00/cyl.
SC	Schlage C Keyway Cylinder 0-Bitted (Rim and #41 Mortise Cylinder Only)	No addition
SE	Schlage E Keyway Cylinder 0-Bitted (Rim and #41 Mortise Cylinder Only)	No addition
SG	MicroShield® an antimicrobial powder coat (not available with 10B)	\$88.00
TB	Thru Bolt	\$26.00

SC/SE-Option not available in 04, 75, 76 ET Trim functions



Center Bearing Bracket for door 48" and over, order using part 98-2162 x finish

\$433.00

Experience a safer
and more open world

Copyright © 2002-2021 Sargent Manufacturing Company, an ASSA ABLOY Group company. All rights reserved.
Reproduction in whole or in part without the express written permission of Sargent Manufacturing Company is prohibited.
Contact us at: 800-727-5477 or visit www.sargentlock.com. In Canada contact us at: 800-461-3007 or visit www.assaabloydss.ca



9900 Series-Mortise Device		
 ET Control	 ET Control	 PTB
Standard Levers: A-B-E-F-J-L-P-W Coastal Levers: G-R-S-Y All Studio Collection Levers (Except Gramercy, Wooster Square, & Grant Park)	Gramercy Series: RAG-RAL-RAM-RAS-RCM-REM-RGM Wooster Square: H001-H002-H003-H004-H005-H006 Grant Park: H007-H008-H009-H010-H011	STS-MAL-FLL-FLW
Finishes listed below are for the exit device. Refer to catalog for available trims, trim finishes and how to order.		

9900 Series		Finish					
Funct.	Description	10BE/32D/ BSP/WSP	03/04/09/10/10B/ 10BL/20D/32	10BE/32D/ BSP/WSP	03/04/09/10/10B/ 10BL/20D/32	10BE/32D/ BSP/WSP	03/04/09/10/10B/ 10BL/20D/32
9910	Exit Only No Trim	\$2,637.00	\$3,273.00				
9910	Dummy Trim					\$3,098.00	\$3,734.00
9904	Key retracts latchbolt	\$3,397.00 *	\$4,033.00 *	\$3,640.00 *	\$4,276.00 *		
9913	Key locks/unlocks control						
9915	Trim always operable						
9928	Thumb piece always operable					\$3,169.00	\$3,805.00
9963	Key locks/unlocks thumb piece						
Electro-Mechanical							
9973*	Fail Safe 12v or 24v	\$3,709.00	\$4,345.00	\$3,902.00	\$4,538.00		
9974*	Fail Secure 12v or 24v						
9975*	Fail Safe 12v or 24v	\$3,966.00 *	\$4,602.00 *	\$4,149.00 *	\$4,785.00 *		
9976*	Fail Secure 12v or 24v						
Note: Specify voltage required when ordering.							

Thru Bolt Application	No. Bolts per pack	Pack Part #	Finish
		1-3/4" Dr.	03/09/10/10B/10BE/10BL/20D/26D/BSP/WSP
9900, 12-9900	4	97-2578	\$25.00 Pack

NOTES:

15 or 26D finishes are available on outside trim only, the exit devices will be supplied in 32D.

14 or 26 Finishes are available on outside trim only, the exit devices will be supplied in 32 finish.

*Not available with Arrow, Best, Falcon Interchangeable Core Options, SC + SE Cylinders.

Cylinder not included when ordered less trim except for 04 function.

ED-46 EXIT DEVICES

SARGENT®

ET LEVER CONTROL TRIM

USA & Canada Prices Effective May 1, 2021



ASSA ABLOY

ET Control

Standard Levers: A-B-E-F-J-L-P-W

Coastal Levers: G-R-S-Y

All Studio Collection Levers
(Except Gramercy, Wooster Square, and Grant Park)

Note: All Exit Trim is priced with cylinder where required. How to order: Trim # x Lever Design – Example: 704ETP x Finish.

700 Series ET Lever Type Trim Function Series (Available as Listed)

TRIM#	EXITS	Finish									
		03/04/09/10/10B/10BE/10BL/14/15/20D/26/26D/BSP/WSP									
704	8304, 12-8304, 8504, 8804, 12-8804, 8888, 12-8888, 8904, 12-8904, 9804, 12-9804, 9904, 12-9904										
706	8706, 12-8706, 8906, 9706, 12-9706										
706-4	8406, 12-MD8406, WD8606, 12-WD8606, MD8606, 12-MD8606										
706-6	SP8606, PP8606, PR8606, LS8606, LP8606, LR8606										
706-8	8506, SP8706, PP8706, PR8706, 8806, NB8706										
710	8310, 12-8310, 8510, 8710, 12-8710, 8810, 12-8810, 8888, 12-8888, NB8710, 8910, 12-8910, 9710, 12-9710, 9810, 12-9810, 9910, 12-9910, SP8710, PP8710, PR8710										
710-4	8410, 12-MD8410, WD8610, 12-WD8610, MD8610, 12-MD8610										
710-6	SP8610, PP8610, PR8610, LS8610, LP8610, LR8610										
713	8313, 12-8313, 8713, 12-8713, 8913, 12-8913, 9713, 12-9713, 9813, 12-9813, 9913, 12-9913										\$760.00
713-4	8413, 12-MD8413, WD8613, 12-WD8613, MD8613, 12-MD8613										
713-6	SP8613, PP8613, PR8613, LS8613, LP8613, LR8613										
713-8	8513, 8888, 12-8888, 8813, 12-8813, SP8713, PP8713, PR8713, NB8713										
715	8315, 12-8315, 8715, 12-8715, 8915, 12-8915, 9715, 12-9715, 9815, 12-9815, 9915, 12-9915										
715-4	8415, 12-MD8415, WD8615, 12-WD8615, MD8615, 12-MD8615										
715-6	SP8615, PP8615, PR8615, LS8615, LP8615, LR8615										
715-8	8515, 8888, 12-8888, 8815, 12-8815, SP8715, PP8715, PR8715, NB8715										
716	8816, 12-8816, 8916, 12-8916										
* 773	8773, 12-8773, 9773, 12-9773										
* 773-4	8473, 12-MD8473, WD8673, 12-WD8673, MD8673, 12-MD8673										
* 773-6	SP8673, PP8673, PR8673, LS8673, LP8673, LR8673										
* 773-8	8573, SP8773, PP8773, PR8773, NB8773, 8873										
* 774	8774, 12-8774, 9774, 12-9774										\$1,072.00
* 774-4	8474, 12-MD8474, WD8674, 12-WD8674, MD8674, 12-MD8674										
* 774-6	SP8674, PP8674, PR8674, LS8674, LP8674, LR8674										
* 774-8	8574, SP8774, PP8774, PR8774, NB8774, 8874										
* 775	8375, 12-8375, 8975, 12-8975, 9875, 9975, 12-9975										
* 775-8	8875, 12-8875										\$1,329.00
* 776	8376, 12-8376, 8976, 12-8976, 9876, 9976, 12-9976										
* 776-8	8876, 12-8876										

* Available in 12v or 24v. Please specify voltage required when ordering.

Experience a safer
and more open world

Copyright © 2002-2021 Sargent Manufacturing Company, an ASSA ABLOY Group company. All rights reserved. Reproduction in whole or in part without the express written permission of Sargent Manufacturing Company is prohibited. Contact us at: 800-727-5477 or visit www.sargentlock.com. In Canada contact us at: 800-461-3007 or visit www.assaabloydss.ca

FREEWHEELING ET LEVER CONTROL TRIM

USA & Canada Prices Effective May 1, 2021



Freewheeling ET Control

Standard Levers: A-B-E-F-J-L-P-W

Coastal Levers: G-R-S-Y

**All Studio Collection Levers
(Except Gramercy, Wooster Square,
& Grant Park)**

Note: All Exit Trim is priced with cylinder where required.
How to order: Trim # x Lever Design – Example: 704ETP x Finish.

740 Series Freewheeling ET Lever Type Trim Function Series (Available as Listed)

TRIM#	EXITS	Finish
		03/04/09/10/10B/10BE/10BL/14/15/20D/26/26D/BSP/WSP
*740	8340, 12-8340, 8540, 8740, 12-8740, SP8740, PP8740, PR8740 8840, 12-8840, 8888, 12-8888, 8940, 12-8940, NB8740	
740-4	8440, 12-MD8440, WD8640, 12-WD8640, MD8640, 12-MD8640	
740-6	SP8640, PP8640, PR8640, LS8640, LP8640, LR8640	
743	8343, 12-8343, 8743, 12-8743, 8943, 12-8943	
743-4	8443, 12-MD8443, WD8643, 12-WD8643, MD8643, 12-MD8643	
743-6	SP8643, PP8643, PR8643, LS8643, LP8643, LR8643	\$760.00
*743-8	8543, 8888, 12-8888, 8843, 12-8843, SP8743, PP8743, PR8743, NB8743	
744	8344, 12-8344, 8544, 8844, 12-8844, 8888, 12-8888, 8944, 12-8944	
746	8746, 12-8746	
746-4	8446, 12-MD8446, WD8646, 12-WD8646, MD8646, 12-MD8646	
746-6	SP8646, PP8646, PR8646, LS8646, LP8646, LR8646	
*746-8	SP8746, PP8746, PR8746, NB8746, 8888, 12-8888, 8846, 12-8846	

*Freewheeling trim ordered separately for 8888.

ED-48 EXIT DEVICES

SARGENT®

ASSA ABLOY

ET LEVER CONTROL TRIM

USA & Canada Prices Effective May 1, 2021



ET Control

Gramercy Levers: RAG-RAL-RAM-RAS-RCM-REM-RGM

Wooster Square Levers: H001-H002-H003-H004- H005-H006

Grant Park Levers: H007-H008-H009-H010-H011

Refer to catalog for available trims, finishes and ordering information.

Note: All Exit Trim is priced with cylinder where required.

700 Series ET Lever Type Trim Function Series (Available as Listed)

TRIM#	EXITS	Finish
		10BE/BSP/WSP/629/630
704	8304, 12-8304, 8504, 8804, 12-8804, 8888, 12-8888, 8904, 12-8904, 9804, 12-9804, 9904, 12-9904	
706	8706, 12-8706, 8906, 9706, 12-9706	
706-4	8406, 12-MD8406, WD8606, 12-WD8606, MD8606, 12-MD8606	
706-6	SP8606, PP8606, PR8606, LS8606, LP8606, LR8606	
706-8	8506, SP8706, PP8706, PR8706, 8806, NB8706	
710	8310, 12-8310, 8510, 8710, 12-8710, 8810, 12-8810, 8888, 12-8888, NB8710, 8910, 12-8910, 9710, 12-9710, 9810, 12-9810, 9910, 12-9910, SP8710, PP8710, PR8710	
710-4	8410, 12-MD8410, WD8610, 12-WD8610, MD8610, 12-MD8610	
710-6	SP8610, PP8610, PR8610, LS8610, LP8610, LR8610	
713	8313, 12-8313, 8713, 12-8713, 8913, 12-8913, 9713, 12-9713, 9813, 12-9813, 9913, 12-9913	\$1,003.00
713-4	8413, 12-MD8413, WD8613, 12-WD8613, MD8613, 12-MD8613	
713-6	SP8613, PP8613, PR8613, LS8613, LP8613, LR8613	
713-8	8513, 8888, 12-8888, 8813, 12-8813, SP8713, PP8713, PR8713, NB8713	
715	8315, 12-8315, 8715, 12-8715, 8915, 12-8915, 9715, 12-9715, 9815, 12-9815, 9915, 12-9915	
715-4	8415, 12-MD8415, WD8615, 12-WD8615, MD8615, 12-MD8615	
715-6	SP8615, PP8615, PR8615, LS8615, LP8615, LR8615	
715-8	8515, 8888, 12-8888, 8815, 12-8815, SP8715, PP8715, PR8715, NB8715	
716	8816, 12-8816, 8916, 12-8916	
* 773	8773, 12-8773, 9773, 12-9773	
* 773-4	8473, 12-MD8473, WD8673, 12-WD8673, MD8673, 12-MD8673	
* 773-6	SP8673, PP8673, PR8673, LS8673, LP8673, LR8673	
* 773-8	8573, SP8773, PP8773, PR8773, NB8773	
* 774	8774, 12-8774, 9774, 12-9774	\$1,265.00
* 774-4	8474, 12-MD8474, WD8674, 12-WD8674, MD8674, 12-MD8674	
* 774-6	SP8674, PP8674, PR8674, LS8674, LP8674, LR8674	
* 774-8	8574, SP8774, PP8774, PR8774, NB8774	
* 775	8375, 12-8375, 8975, 12-8975, 9875, 9975, 12-9975	
* 775-8	8875, 12-8875	
* 776	8376, 12-8376, 8976, 12-8976, 9876, 9976, 12-9976	\$1,512.00
* 776-8	8876, 12-8876	

* Available in 12v or 24v. Please specify voltage required when ordering.

Experience a safer
and more open world

Copyright © 2002-2021 Sargent Manufacturing Company, an ASSA ABLOY Group company. All rights reserved. Reproduction in whole or in part without the express written permission of Sargent Manufacturing Company is prohibited. Contact us at: 800-727-5477 or visit www.sargentlock.com. In Canada contact us at: 800-461-3007 or visit www.assaabloydss.ca

FREEWHEELING ET LEVER CONTROL TRIM



USA & Canada Prices Effective May 1, 2021

Freewheeling ET Control

Gramercy Levers: RAG-RAL-RAM-RAS-RCM-REM-RGM

Wooster Square Levers: H001-H002-H003-H004- H005-H006

Grant Park Levers: H007-H008-H009-H010-H011

Refer to catalog for available trims, finishes and ordering information.

Note: All Exit Trim is priced with cylinder where required.

740 Series Freewheeling ET Lever Type Trim Function Series (Available as Listed)

TRIM#	EXITS	Finish 613/629/630
740	8340, 12-8340, 8540, 8740, 12-8740, SP8740, PP8740, PR8740 8840, 12-8840, 8888, 12-8888, 8940,12-8940, NB8740	
740-4	8440, 12-MD8440, WD8640, 12-WD8640, MD8640, 12-MD8640	
740-6	SP8640, PP8640, PR8640, LS8640, LP8640, LR8640	
743	8343, 12-8343, 8743, 12-8743, 8943, 12-8943	
743-4	8443, 12-MD8443, WD8643, 12-WD8643, MD8643, 12-MD8643	
743-6	SP8643, PP8643, PR8643, LS8643, LP8643, LR8643	\$1,003.00
* 743-8	8543, 8888, 12-8888, 8843, 12-8843,SP8743, PP8743, PR8743, NB8743	
744	8344, 12-8344, 8544, 8844, 12-8844, 8888, 12-8888, 8944, 12-8944	
746	8746, 12-8746	
746-4	8446, 12-MD8446, WD8646, 12-WD8646, MD8646, 12-MD8646	
746-6	SP8646, PP8646, PR8646, LS8646, LP8646, LR8646	
746-8	SP8746, PP8746, PR8746, NB8746, 8888, 12-8888, 8846, 12-8846	

*Freewheeling trim ordered separately for 8888.

ED-50 EXIT DEVICES

SARGENT®

PULL & THUMBPIECE TRIM

ASSA ABLOY

USA & Canada Prices Effective May 1, 2021



800 Series Pull & Thumbpiece Trim			
Function	Trim	Description	All Finishes
802	PTB	Blank Plate with screw holes	\$313.00
810	FLL, FLW, MAL, PTB, STS	10	
814	FLL, FLW, MAL, PTB, STS	04	
814	FSL, FSW, PSB, MSL	*8804/8888 only	\$461.00
828	FLL, FLW, MAL, PTB, STS	28	
866	FLL, FLW, MAL, PTB, STS	62, 63, 66	
800 Series Offset Pull			
			32D 03/04/10/10B/10BE/32/BSP/WSP
862	10" Pull – 1" Diameter	\$294.00	\$317.00
863	18" Pull – 1" Diameter	\$366.00	\$393.00
864	10" Pull – 3/4" Diameter	\$257.00	\$278.00

FLW, FSW Trim Not Available in 32 & 32D.

*Supplied with revised cylinder hole location and thru-bolting.

USA & Canada Prices Effective May 1, 2021

80 Series Push Bar Only- No Trim		Finish	
Function	Description	10BE/32D/BSP/WSP	03/04/09/10/10B/10BL/20D/32
8893	Inactive Rail	\$879.00	\$977.00
*8895	Active Rail	\$949.00	\$1,040.00

Thru Bolt Application		Pack Part #		Finish
No. Bolts per pack	1-3/4" Dr.	2-1/4" Dr.	03/04/09/10/10B/10BE/10BL/15/20D/26D/BSP/WSP	
8893/8895 (4)	4	68-2279	68-2280	\$25.00 Per Pack
Thru Bolts ordered with device				\$6.00 Each
*55- For 8895 – Signal Switch in Rail				Add \$241.00
SG is available for 8893 and 8895 MicroShield® an antimicrobial powder coat				Add \$88.00



Anti-Vandal Pull Trim		Price
Catalog #	Description	32D
821	used with MD/WD8610, 8710, 8810, 9710, 9810	
824	used with 8904, 9904	
826	used with 8804 (mfg. after 2/2001)	\$665.00
827	used with 8910, 9910	



Auxiliary Control

Auxiliary Outside Controls		Finish
No./Series (Avail. as Listed)	03/04/09/10/10B/10BE/10BL/14/15/20D/26/26D/32/32D/BSP/WSP	
106	8400, WD8600, MD8600	
113	8400, WD8600, MD8600	
306	8700, 12-8700, 9700, 12-9700	
313	8700, 12-8700, 9700, 12-9700	\$760.00
NB-306 NB8700		
NB-313 NB8700		

Note: Cannot be used with PP/SP/PR8700 & 8600 Devices.

MULLIONS & ACCESSORIES

USA & Canada Prices Effective May 1, 2021

Mullions			10B	28	Prime Coat
Option	Catalog #	Description			
	650A	Removable Mullion - Alum. Anodized - used w/8500 ser. Exit Device only	\$1,996.00	\$1,641.00	
	980	Removable Mullion - Extruded Aluminum			\$756.00
	980A	Removable Mullion - Aluminum Anodized	\$2,078.00	\$1,703.00	
	980S	Removable Mullion - Steel - Non-Fire Rated			\$756.00
	HC980	Hurricane Code Mullion - Steel			\$1,127.00
	HCL980	Lockable Hurricane Code Mullion - Steel			\$1,664.00
12	980	Removable Mullion - Steel - U.L. Fire Rated			\$983.00
12	HC980	Hurricane Code Mullion - Steel - U.L. Fire Rated			\$1,354.00
12	HCL980	Hurricane Code Lockable Mullion - Steel - U.L. Fire Rated			\$1,891.00
12	HD980	UL fire Listed up to 3 hours on 4' x 10' single door applications and 8' x 10' double door applications (w/12-8800 Rim Device)			\$1,105.00
	L980	Lockable Mullion - Aluminum			\$1,330.00
	L980A	Lockable Mullion - Aluminum Anodized	\$2,624.00	\$2,307.00	
	L980S	Lockable Mullion - Steel - Non-Fire Rated			\$1,330.00
12	L980	Lockable Mullion - Steel - U.L. Fire Rated			\$1,557.00
	EL980	Lockable Mullion - Steel - Electric - Max height is 96" - consult factory for other.			\$1,606.00
	651	Mullion Stabilizer Kit - included w/650A Mullion			\$57.00
	988	Surface Bolt Kit - Used in Hurricane Code applications – Bright Zinc Plated Finish			\$164.00

Mullion standard stock size is 96". The UL listed products are available as 8' only. This covers all 12- mullions with the exception of 12-HD980 which comes standard at 120".

Mullions Available up to 120" – All mullions over 96" add \$130.00

EL980: Consult Factory

Note: All lockable mullions are supplied less cylinder.

Cylinder must be ordered separately. See below available cylinder options and kits.

Mullion Cylinder Kits			Price
Option	Description		
10	SARGENT Signature System		\$63.00
11	SARGENT XC Key System (not available with 10, 22, SC, SE options)		No addition
1160	Sargent XC Large Format Interchangeable Plastic Disposable Construction Core		No addition
1163	Sargent XC Large Format Interchangeable Core Cylinder - Includes master keying charges		\$83.00
1164	Sargent XC Large Format Interchangeable Construction Core Cylinder		\$83.00
1170	Small Format interchangeable disposable construction core - to accept 7 Pin XC permanent core		No addition
11727P	Small Format interchangeable keyed construction core - to accept 7 Pin XC permanent core		\$75.00
11737P	Small Format interchangeable core - to accept 7 pin XC permanent core		\$75.00
21	SARGENT Construction Key System (lost ball)		\$16.00
22	Construction Key System (split key)		\$32.00
60	SARGENT Large Format Interchangeable Plastic Disposable Construction Core		No addition
63	SARGENT Large Format Interchangeable Core Cylinder includes master and grandmaster keying charge		\$83.00
64	SARGENT Large Format Interchangeable Construction Core Cylinder		\$83.00
6573	Small Format 6-Pin Uncombined Core		\$65.00
65737P	Small Format 7-Pin Uncombined Core		\$65.00
70	Small Format interchangeable disposable plastic construction core		No addition
72	Small Format interchangeable 6-Pin construction core		\$75.00
73	Small Format interchangeable core 6-pin		\$75.00
737P	Small Format interchangeable core 7-pin		\$75.00
81	Cylinder to accept KESO and KESO F1 removable core - no core provided		No Addition
F182	SARGENT KESO F1 Security Cylinder (Patented)		\$91.00
82	SARGENT KESO Security Cylinder (existing Key Systems only)		\$91.00
F183	SARGENT KESO Security Cylinder removable core key system - Patented		\$130.00
83	SARGENT KESO Security Cylinder removable core key system		\$130.00
84	SARGENT KESO Security Cylinder construction removable core system		See page CK-18
BR	SARGENT Bump Resistant Cyls. (N/A w/10, 22, 30, 60, 63, 64, 70, 72, 73, 737P, KESO, SC, & SE prefixes)		\$25.00
DG1	Patented Degree DG1 Key System		No addition
DG160	Hardware prepared for DG1-6300 Lg. Format IC cores, supplied with temporary plastic construction cores		No addition
DG163	Patented Degree DG1 Large Format Interchangeable Core Cylinder - Includes master keying charges		\$83.00
DG164	Hardware prepared for DG1-6300 Lg. Format IC cores, supplied with temporary keyed construction cores		\$83.00
DG2	Patented Degree DG2 Key System incorporating a locking sidebar		\$63.00/cyl.
DG260	Hardware prepared for DG2-6300 Lg. Format IC cores, supplied with temporary plastic construction cores		No addition
DG263	Patented Degree DG2 Large Format Interchangeable Core Cylinder - Includes master keying charges		\$146.00
DG264	Hardware prepared for DG2-6300 Lg. Format IC cores, supplied with temporary keyed construction cores		\$83.00
DG3	Patented Degree DG3 Key System incorporating a locking sidebar and UL437 listed		\$89.00/cyl.
DG360	Hardware prepared for DG3-6300 Lg. Format IC cores, supplied with temporary plastic construction cores		No addition
DG363	Patented Degree DG3 Large Format Interchangeable Core Cylinder - Includes master keying charges		\$172.00
DG364	Hardware prepared for DG3-6300 Lg. Format IC cores, supplied with temporary keyed construction cores		\$83.00
SC	Schlage "C" keyway cylinder 0- bitted only		No Addition
SE	Schlage "E" keyway cylinder 0- bitted only		No Addition

USA & Canada Prices Effective May 1, 2021

Mullion Cylinder Kits		
Catalog#	Description	Price
980C1	Steel & aluminum mullions (HCL980, 12-HCL980, L980S, L980, 12-L980, L980A)	\$97.00
980C2	Electric mullion (EL980)	
Mullion Accessories and Parts		
502	Bottom Retainer Pack for 980	\$172.00
507	Adaptor for narrow transom bars (Aluminum x prime) for 980	\$62.00
507A	Adaptor for narrow transom bars (Aluminum x anodized) for 980A	\$89.00
511	Top Retainer Pack for 980	\$166.00
601	Top Retainer Shim Kit for All Steel Mullions	\$57.00
RK980	Latchbolt Assembly Retrofit Kit (Includes Top & Bottom Retainers for L980, converts 980 to L980)	\$715.00
94-2050	Top Retainer Pack for 650A	\$151.48
94-2051	Bottom Retainer Pack for 650A	\$151.48
98-2190	Top Retainer Pack for 12-980	\$196.91
98-2191	Bottom Retainer Pack for 12-980	\$130.31
98-2525	Bottom Retainer Pack for L980	\$130.31
98-2526	Top Retainer Pack for L980	\$130.31
98-2556	Bottom Retainer Pack for 12-L980	\$130.31
98-2558	Top Retainer Pack for EL980	\$196.91
98-2559	Top Retainer Pack for 12-L980	\$196.91
98-2578	Wall Mounting Kit for L980	\$201.16
98-2579	Wall Mounting Kit for L980S	\$290.41
98-2580	Wall Mounting Kit for EL980	\$290.41
98-2599	Top Retainer Pack for HC980, 12-HC980, and 12-HD980	\$208.24
98-2593	Top Retainer Pack for HCL980 & 12-HCL980	\$208.24
98-2594	Bottom Retainer Pack for HCL980 & 12-HCL980	\$208.24
98-2600	Bottom Retainer Pack for HC980, 12-HC980, and 12-HD980	\$208.24

ED-54 EXIT DEVICES

SARGENT®

ACCESSORIES

ASSA ABLOY

USA & Canada Prices Effective May 1, 2021

Exit Device Mortise Locks (less cylinders)	Finish
	03/04/09/10/10B/10BE/10BL/15/20D/26/26D/BSP/WSP
904, 906, 910, 913, 915, 916, 928, 940, 943, 944, 946, 963, 966, 973, 974, 975, 976, 977, 978 – specify hand when ordering	\$662.00

Cylinder Dogging Kits (30/80 Series)	03/04/09/10/10B/10BE/10BL/20D/32/32D/EN/EB/ED/BSP/WSP
816-1 For use with Wide Stile F Rail	
816-2 For use with Narrow Stile E & F Rail	
816-3 For use with Wide Stile G Rail	
816-4 For use with Narrow Stile G Rail	\$203.00
816-5 For use with Wide Stile E Rail	
816-6 For use with Narrow Stile J rail	
816-7 For use with Wide Stile J rail	

Vertical Rod Extension	03/04/09/10/10B/10BE/10BL/20D/26/26D/32/32D/EN/EB/ED/BSP/WSP
570 Rod Connector Kit (68-2745) – No finish required	\$48.00
571-6 6" Rod Extension Kit for 9700/2700/3700 (old style 8700)	\$90.00
571-12 12" Rod Extension Kit for 9700/2700/3700 (old style 8700)	\$114.00
571-18 18" Rod Extension Kit for 9700/2700/3700 (old style 8700)	\$132.00

New Top Rods, New Style 8700 SVR Devices	
687-6 Top Rod for 8700 41" AFF – 90" Door (new style 8700's), PP/PR/SP8700	\$99.00
687-12 Top Rod for 8700 41" AFF – 96" Door (new style 8700's), PP/PR/SP8700	\$114.00
687-18 Top Rod for 8700 41" AFF – 102" Door (new style 8700's), PP/PR/SP8700	\$132.00

*Glass Bead Shim Kits (1/4" thick)	ED/EN/EB/EP/EAB/ERD
529 For 12-3727	\$180.00
537 For 12-8700, NB8700, 12-NB8700 (N/A in ED & ERD)	\$181.00
553 For Flush End Cap (N/A in ED & ERD)	\$99.00
558 For 3828 and 12-3828	\$159.00
559 For 3727	\$185.00
568 For 2828 and 12-2828 (N/A in EP & ERD)	\$159.00
569 For FM8700	\$188.00
587 For 8700	\$188.00
588 For 2727	\$193.00
589 For 8600, 12-8600, 8800, 12-8800, 8900, 12-8900	\$148.00
668 For 12-8300, 12-8400, 8500	\$141.00
598 For 12-2727	\$193.00

*Note: Shim kits may offset outside trim. Longer spindles and thru bolts may be required. Consult factory.

Security Shim Kit	
541 Shim Kit	\$233.00

Stock Hollow Metal Door Kit	
543 Stock Hollow Metal Door Kit	\$52.00

AL-Retrofit Kit	(Used to modify existing exit devices to Alarmed- for 8300, 8500, MD/WD 8600, 8700, and 8900 only)	Finish
		03/04/09/10/10B/10BE/10BL/20D/32/32D/BSP/WSP

545-1 For use with 8F Wide Rails	
545-2 For use with 8F & 8E Narrow Rails	
545-3 For use with 8G Wide Rails	
545-4 For use with 8G Narrow	\$761.00
545-6 For use with 8J Narrow Rails	
545-7 For use with 8J Wide	

Note: Cylinder not included; order cylinder separately.

Options For Push Rail Assembly Kit	Add
19 Pushbar without Lexan Touchpad	No Addition
HK Hex Key Dogging	No Addition
55 Signal Switch	\$241.00
SG MicroShield® an antimicrobial powder coat (not available with 10B)	\$88.00

Push Rail Assembly Kit	Finish
	03/04/09/10/10B/10BE/10BL/20D/32/32D/BSP/WSP

R56A* Retrofits standard mechanical rail	
R56B* Retrofits 53- Exit Devices. Does not include 53- signal switch.	\$1,454.00

* Please specify rail length (E, F, G, J) and finish.

How To Order: R56A (Kit #) x F (Rail Size) x 32D (Finish)

Motor Assembly Kit (Can be added to 80 Series Devices** mfg. after 2006 & P Series Exit Device)	
---	--

M56A Retrofits standard mechanical rail	
M56B Retrofits 53- Exit Devices. Does not include 53- Signal Switch	\$852.00

Note: Please specify rail length. Only 55- option is available with the M56 kits.

**Motor Retrofit Kits are not available on FM8700 Series Exit Devices

How To Order: M56A (Kit #) x F (Rail Size)

Experience a safer
and more open world

Copyright © 2002-2021 Sargent Manufacturing Company, an ASSA ABLOY Group company. All rights reserved.
Reproduction in whole or in part without the express written permission of Sargent Manufacturing Company is prohibited.
Contact us at: 800-727-5477 or visit www.sargentlock.com. In Canada contact us at: 800-461-3007 or visit www.assaabloydss.ca

Touch Pad		Black
809	Lexan Touchpad for 80 series	\$42.00
807	SARGuide™ – Lamp Replacement Kit	\$86.00

Miscellaneous		
*565	Metal End Cap Kit	\$69.00
576	Bottom Pullman Bolt Conversion Kit	\$357.00
*665	Flush end Cap	\$69.00
584K	Wood Door Kit	\$77.00
*981	Cross Bar Replacement Kit for 90 Series (except for 9400)	\$380.38

607 ET Locking Slide Replacement Kits – Kits include a new screw, lead washer, spring and locking slide. Retrofits to all existing trims.		
Part #		Price

607-1	For all 713 Lockable ET Controls	
607-2	For all 706 Lockable ET Controls	
607-3	For all 743 Freewheeling ET Controls	\$120.00
607-4	For all 746 Freewheeling ET Controls	
607-5	For all 746-6 Freewheeling ET Controls	

730 Retrofit Kits – ET Spindle Retrofit Kit – Includes Spindle, Retainer Plate, Screw & Washer		
Part #		Price

730-1	700 Series Spindle 1-3/4" Door	
730-2	700 Series Spindle 2" Door	
730-3	700 Series Spindle 2-1/4" Door	
730-4	700-4 Series Spindle 1-3/4" Door	
730-5	700-4 Series Spindle 2" Door	\$54.00
730-6	700-4 Series Spindle 2-1/4" Door	
730-7	700-8 Series Spindle 1-3/4" Door	
730-8	700-8 Series Spindle 2" Door	
730-9	700-8 Series Spindle 2-1/4" Door	

Top Rod Kits (Door and Mounting Heights Are Required)		
Part #		Price

MD660T	AD8400, AD8600, MD8400, MD8600	\$54.00
WD660T	WD8600	\$54.00
WDA660T	WD8600 x Aux	\$54.00
661P	PP/PR/SP8600	\$48.00
661L	LP/LR/LS8600	\$40.00
*670T	8700, and 9700	\$112.00
*672T	2700 and 3700	\$134.00
692P	PP,PR,SP8600	\$95.00
MD691T	Top Rod for MD8600	\$95.00
WD691T	WD8600	\$95.00
WDA691T	Aux Control WD8600	\$95.00

Bottom Rod Kits (Mounting Height is Required)		
Part #		Price

660B	AD8400, MD8400, AD8600, MD8600, WD8600, & WD8600 x Aux	\$47.38
*670B	8700, and 9700	\$110.85
*672B	2700 and 3700	\$132.35
691B	AD8400, MD8400, MD8600 & WD8600	\$74.51

ET Trim Retrofit Kit		03/04/09/10/10B/10BE/ 15/20D/26/26D/BSP/WSP
Part #	Description	

688	Retrofit Kit – used with 700 Series ET trim for direct bolt-on to existing Von Duprin preps	\$129.00
Note: *Require finish		

ED-56 EXIT DEVICES

SARGENT®

STRIKES

ASSA ABLOY

USA & Canada Prices Effective May 1, 2021

Part Number	Description	Black Nylon Coated
606	Standard Bottom Strike - 12-MD8400, (12)MD8600, (12)WD8600	\$65.15
613	Alternate Half Mortise Strike - 2828, 3828, 8800, 9800	\$93.09
624	Standard Bottom Strike - 2727, 3727, 8700, 9700	\$65.15
639	Top Strike for Aluminum frame Concealed Vertical Rod	\$19.13
640	Top & Bottom Strike - AD8400 & AD8600	\$38.24
642	Full Mortise Strike - 2828, 3828, 8800, 9800	\$65.15
644	Surface or Double Dr Strike 2828, 3828, 8800, 9800	\$84.32
646	Top Strike - (12)2727, (12)3727, (12)(14)(NB)8700, (12)(14)9700	\$88.15
648	Flush Panel Strike - 2727, 3727, 8700, 9700	\$95.83
649	Standard Strike - (12)2828, (12)3828, 8500, (12)8800, (12)8888, (12)9800, (12)9898	\$90.10
650	Standard Top Strike - (12)(NB)MD8400, (12)(NB)MD8600, (12)WD8600	\$38.31
652	Standard Top & Bottom Strike MD8400, MD8600, WD8600	\$76.66
653	Alternate Bottom Strike - 12-2727, 12-3727, 12-8700, 12-9700	\$130.32
654	Top Plate - 12-2727, 12-3727, 12-8700, (12)HC8700	\$135.99
655	Standard Bottom Strike 12-2727, 12-3727, 12-8700, (12)HC8700, 12-9700, 12-9700, 14-8700, 14-9700	\$38.31
656	Alternate Bottom Strike - 2727, 3727, 8700, 9700	\$38.31
657	Standard Strike - 8500(single door)	\$122.67
658	Standard Strike - 650A mullion	\$65.15
658	Alternate Strike - 8500, 8800	\$65.15
659	Top Strike	\$135.74
** 815	Open Back Strike - 8300, 8900, 9900 - for door thickness over 1-3/4", consult factory	\$90.07
908	Flat lip strike 8300, 8900, 9900	\$36.50
** C908	Curved lip strike 8300, 8900, 9900 - for door thickness over 2-1/4", consult factory	\$38.31
608	Flush Panel Adaptor - 12-8700, 12-9700	\$122.67
68-1183	Double lipped mortise strike LR8600, PR8600, PR8700	\$97.47
C7710	Mortise center case strike LS8600, SP8600, SP8700	\$41.98

** When ordering, specify hand (RHR or LHR)

649 Shim Plate		Prime Coat Gray
98-0036	Shim for 649 Strike	\$27.65

Experience a safer
and more open world

Copyright © 2002-2021 Sargent Manufacturing Company, an ASSA ABLOY Group company. All rights reserved. Reproduction in whole or in part without the express written permission of Sargent Manufacturing Company is prohibited. Contact us at: 800-727-5477 or visit www.sargentlock.com. In Canada contact us at: 800-461-3007 or visit www.assaabloydss.ca

USA & Canada Prices Effective May 1, 2021

Part No.	Price	Part No.	Price
01-0007 Groove Pin	\$1.07	*01-3192 #10-24 x 3/4" machine screw	\$1.07
01-0008 Groove Pin	\$1.07	01-3384 #8-32 x 7/16" Ph. Fl. Mach. Screw	\$1.07
01-0009 Groove Pin	\$3.65	*01-3454 1/4" - 20 x 1-1/4" machine screw	\$2.41
01-0011 Lock Washer	\$0.71	*01-3458 1/4" - 20 x 2-1/4" machine screw	\$1.86
01-0013 Machine Screw	\$1.42	01-3563 01-3563 #5- 40 x 1/4" machine screw	\$1.07
01-0014 Screw	\$2.84	01-3565 #5- 40 x 3/8" machine screw	\$1.42
01-0048 Roll Pin	\$1.07	01-3579 6-32 x 1/16" Ph. Rd. Hd. screw	\$0.66
01-0074 Retaining Ring	\$1.07	01-3582 #6-32 x 3/8" machine screw	\$1.07
01-0084 Retaining Ring	\$1.07	*01-3595 #8-32 x 1/4" machine screw	\$1.07
01-0098 Retaining Ring	\$1.07	01-3622 #10-24 x 3/4" machine screw	\$1.84
01-0204 5/22" washer	\$1.07	01-4011 #6-32 x 5/16" machine screw	\$0.66
*01-0225 C -sunk washers (TB mounting)	\$4.08	01-4195 4-40 x 3/8" machine screw	\$0.66
01-0227 15/64" lock washer	\$0.71	01-4372 Thru bolts 2" Dr. 700, 700-5, 716 ET	\$5.28
01-0273 Roll Pin	\$1.07	01-4373 Thru bolts 2" 1/4" Dr. 700, 700-5, 716 ET	\$5.63
01-0288 Socket screw key	\$4.27	01-4383 Machine Screw	\$0.54
01-0401 Spiral Pin	\$2.24	01-4442 #10-24 x 1-5/8" machine screw	\$1.42
01-0402 Roll Pin	\$1.07	*01-4445 1/4" - 20 x 1-1/2" machine screw	\$1.84
01-0408 Washer	\$1.07	01-4451 Thru bolts 1-3/4" Dr. 700, 700-5, 700-1, 716 ET	\$1.86
01-0461 Spiral Pin	\$1.42	01-4464 Screw for FW Trim	\$1.73
01-0476 Nyliner	\$1.00	01-4507 Groove Pin	\$0.62
01-0496 Cable clamp	\$1.00	01-4537 Standard Hole Plug	\$0.60
01-0507 Cable clamp	\$1.37	01-5001 #10-24 x 3/4" combination screw	\$1.23
01-0550 Lead washer	\$4.27	01-9342 SCREW 10-24 X 2 1/2	\$1.46
01-0610 Wave Spring Washer	\$2.84	*08-4320 Plain knob assembly	\$85.54
01-0669 3/8" - 16 UNC flex lock nut	\$4.27	13-0074 Screw	\$0.73
01-0695 Spiral Pin	\$1.40	13-0075 Rim cylinder connecting screw 2-1/4"	\$1.88
01-0696 Spiral Pin	\$1.07	13-0080 Rim cylinder barrel retainer	\$1.71
01-0697 Spiral Pin	\$1.07	13-0085 Rim cylinder locking tail	\$1.71
01-0700 "O" Ring	\$3.48	13-0086 Rim cylinder back plate	\$2.50
01-0701 Spiral Pin	\$2.10	13-0180 ET rail cylinder nut	\$4.27
01-0704 Socket Head Set Screw	\$1.84	13-0664 Slotted cam	\$5.44
01-0710 Washer (.012" thick)	\$1.07	13-2099 Cylinder Retainer Pack for 8504/8544 functions	\$31.32
01-0711 Flanged Nyliner	\$1.84	13-2162 Cylinder Attachment RH	\$72.38
01-0712 Rubber Bumper	\$1.38	*21-0165 Grip	\$204.68
01-0715 Lock Washer	\$1.07	*28-0005 2710 & 2727 Cover	\$54.30
01-0749 Groove Pin	\$1.07	*28-0006 2828 Cover	\$54.30
01-0766 Hex Machine Screw Nut	\$0.71	*28-0018 Push Rail "E"	\$126.00
01-0797 Spiral Pin	\$2.24	*28-0019 Push Rail "F"	\$126.00
01-0836 Spiral Pin 1/8" x 7/8" HDP	\$1.23	*28-0021 Push Rail "G"	\$126.00
01-1095 Set Screw	\$0.71	28-0026 Pivot Pin	\$6.40
01-1121 #3-48 x 5/16" fl. hd. mach. screw (Price/Pack - 100 screws)	\$31.40	28-0033 Main slide pin	\$6.32
01-1137 Screw #8-32 x 7/16"	\$1.42	28-0035 Main slide	\$76.02
*01-1141 8-32 x 3/8" Ph. Machine Screw	\$1.42	28-0036 Lift lever	\$32.55
01-1142 8-32 x UNC - 2A x 1/4" Screw	\$0.80	28-0037 Slide guide pin	\$2.76
01-1145 #4-40 x 1/4" Ph. Mach. Screw	\$1.00	28-0038 Latchbolt lever	\$4.21
01-1146 #8-32 x 3/8" Ph. Fl. Screw	\$1.00	28-0109 Cam	\$1.39
01-1182 Socket head cap screw	\$2.65	*28-0110 End cap (30)	\$19.56
01-1183 Truss head machine screw	\$0.73	*28-0111 3828 Series Chassis Cover	\$138.38
01-1190 Self tapping screw	\$1.86	*28-0116 3727 Cover	\$138.38
*01-1209 #8-32 x 1/2" Machine Screw	\$2.24	*28-0119 Top & Bottom - 3727Cover	\$54.30
01-1484 Machine Screw & Washer (01-0011)	\$0.71	*28-2011 Rail Assy. Cam Lockdown "E" (24" - 30")	\$369.21
01-1493 Bar Locking Screw	\$1.92	*28-2012 Rail Assy. Cam Lockdown "F" (30" - 36") (20)	\$369.21
01-1494 Bar Locking Screw (90)	\$2.12	*28-2014 Rail Assy. Cam Lockdown "G" (36" - 48") (20)	\$369.21
*01-2089 #10 x 1" Wood Screw	\$1.84	*28-2026 Screw Pk	\$7.89
01-2455 10 x 1-1/4" Ph. Rd. Wood Screw	\$1.84	28-2028 2710 Chassis Assy. less cover LHRB	\$238.93

*Specify hardware or painted finish required. Consult catalog for available finishes.

ED-58 EXIT DEVICES

SARGENT®

ASSA ABLOY

PARTS

USA & Canada Prices Effective May 1, 2021

Part No.	Price	Part No.	Price
28-2029	2710 Chassis Assy. less cover RHRB	68-0261	Thumb Piece Lever RHRB
*28-2066	12- Rail Assy. E (24" - 30") (20)	68-0271	Pivot Pin
*28-2067	12- Rail Assy. F (30" - 36") (20)	68-0273	Bushing
*28-2069	12- Rail Assy. G (36" - 48") (20)	68-0311	Cam (cylc. Lockdown) 16-60
28-2146	12-2828 Chassis Assy. less cover – Old Style	68-0323	Chassis Pin
28-2147	2800 CTR Case Pack – New Style	68-0324	Lift Lever Pivot Pin
28-2148	12-2800 CTR Case Pack – New Style	68-0327	Main Slide
28-2157	2727 Chassis Assy. less cover LHRB – Old Style	68-0337	Lift lever LHRB
28-2158	2727 Chassis Assy. less cover RHRB – Old Style	68-0338	Lift lever RHRB
28-2408	New 2828/3828 Chas Asy Less Cvr	68-0367	Knob Hub Cover
28-2409	12- 20/30 Chassis Asy less Cvr – New Style	68-0368	Locking slide spring LHRB
28-2427	New 2737/3727 Chassis Asy less Cvr	*68-0405	Cover (8700)
28-2428	New 2727/3727 R Chas Asy Less Cvr	*68-0406	Cover (12-8888 & 8888)
*28-2435	3828 Center Case Pack	*68-0407	Cover (8900)
*28-2446	30 Ser RI Asy E Cam Lockdown (24" - 30")	*68-0408	Cover LHRB 8616/66
*28-2447	30 Ser RI Asy F Cam Lockdown (30" - 36")	*68-0409	Cover RHRB 8616/66
*28-2448	30 Ser RI Asy G Cam Lockdown (36" - 48")	*68-0410	Cover LHRB 8916/66
*28-2449	30 Ser RI Asy E 16- (28" - 32")	*68-0411	Cover RHRB 8916/66
*28-2450	30 Ser RI Asy F 16- (32" - 36")	68-0419	Guide spring
*28-2451	30 Ser RI Asy G 16- (44" - 48")	68-0434	Endcap for 20 Series
*28-2452	30 Ser RI Asy E 12- (24" - 30")	68-0456	latchbolt (12-9800)
*28-2453	30 Ser RI Asy F 12- (30" - 36")	68-0477	Lift lever LHRB
*28-2454	30 Ser RI Asy G 12- (36" - 48")	68-0478	Lift lever RHRB
*28-2457	Top Latch Asy	68-0482	Latchbolt (8500)
*28-2491	3727 Bottom Chassis Asy w/ Cvr	68-0484	Endcap for 6300-6500 exits
*28-2492	12-3727 Bottom Case Asy w/ Cvr	68-0489	Lift lever LHRB 1-3/4" door (8300)
*28-2493	12-3727 Top Case Asy w/ Cvr	68-0490	Lift lever RHRB 1-3/4" door (8300)
*28-2494	3727 Top Case Asy w/ Cvr	68-0491	Lift lever LHRB 2-3/4" door (8300)
32-1213	Bracket for 5100	68-0492	Lift lever RHRB 2-3/4" door (8300)
32-1254	Machine screw	*68-0495	Cover (8500)
52-2285	Mullion Wire Conn. Assy.	*68-0496	Cover (8300/8400)
52-2558	59-80 Circuit Brd asy	68-0511	Mounting Plate
52-2997	57- F Circuit Board Kit	68-0536	Lift lever LHRB (8400)
52-2998	57-J Circuit Board Kit	68-0537	Lift lever RHRB (8400)
52-2999	57- G Circuit Board Kit	*68-0549	Mounting rail insert "F" – Wide
52-5052	59-Circuit Brd Repl. Kit	*68-0550	Mounting rail insert "E" – Wide
68-0007	Foam Rod Bushing	*68-0551	Mounting rail insert "G" – Wide
68-0011	Main Slide Asy - MD8600	*68-0552	Mounting rail insert "G" – Narrow
68-0012	Roller (Main slide)	*68-0553	Mounting Rail Insert "J" – Narrow
68-0030	Rail Shipping plug	*68-0554	Mounting rail insert "J" – Wide
68-0037	Bottom Case (8400)	68-0559	700-1 Lever
68-0101	CENTER LINK LH	68-0561	Lexan end cap for 80 series
68-0102	CENTER LINK RH	*68-0574	Shim for 8893/8895
*68-0201	Mtg. Rail 8893E	68-0582	Lock down cam
*68-0202	Mtg. Rail 8893F	68-0583	Lockdown button (20 & 80)
*68-0204	Mtg. Rail 8893G	*68-0585	F push rail (16- cylinder lockdown)
*68-0229	Pivot Pin (Push Rail)	*68-0615	Push rail "E"
68-0233	Mounting Plate	*68-0616	Push rail "J"
68-0236	Connecting Arm Spring	*68-0617	Push rail "G"
68-0237	latchbolt Lever LHRB	*68-0618	Push Rail "F"
68-0238	latchbolt Lever RHRB	*68-0632	Mounting rail insert, inactive "F"
68-0239	Lift Arm Pivot Pin	*68-0633	Mounting rail insert, inactive "G"
68-0240	Thumb piece lever (blank)	*68-0635	Shim (top & bottom case)
68-0241	Lift Arm	*68-0636	Shim (mounting plate) glass bead
68-0260	Thumb Piece Lever LHRB	*68-0637	Shim (guide case) glass bead

*Specify hardware or painted finish required. Consult catalog for available finishes.

Experience a safer
and more open world

Copyright © 2002-2021 Sargent Manufacturing Company, an ASSA ABLOY Group company. All rights reserved.
Reproduction in whole or in part without the express written permission of Sargent Manufacturing Company is prohibited.
Contact us at: 800-727-5477 or visit www.sargentlock.com. In Canada contact us at: 800-461-3007 or visit www.assaabloydss.ca

USA & Canada Prices Effective May 1, 2021

Part No.	Price	Part No.	Price
* 68-0638 Shim (C-case) glass bead kit	\$38.34	* 68-1042 Mtg. Rail F-narrow	\$334.77
68-0639 Rod Connector (570 & 571)	\$22.99	* 68-1043 Mtg. Rail J-narrow	\$334.77
68-0644 Hooked tool	\$4.30	* 68-1044 Mtg. Rail G-narrow	\$334.77
68-0663 Shrink Tube	\$1.46	* 68-1058 Mtg. Rail F-wide	\$334.77
68-0674 Wire mesh guard (80 del)	\$5.34	* 68-1059 Mtg. Rail J-wide	\$334.77
68-0691 Mounting plate end cap	\$32.22	* 68-1060 Mtg. Rail G-wide	\$334.77
68-0729 80 Series Rail Plug	\$1.64	* 68-1085 Switch latchbolt monitor	\$51.30
* 68-0737 PS Rail (Cam) 12-8J	\$231.74	* 68-1086 Switch latchbolt monitor	\$51.30
* 68-0738 PS Rail (Cam) 12-8G	\$248.33	68-1090 Lift Lever	\$34.08
* 68-0767 Mounting rail insert 16-8F W	\$131.35	68-1096 Spring (guard)	\$5.98
* 68-0768 Mounting rail insert 16-8E W	\$131.35	68-1137 Lift Lever	\$99.34
* 68-0769 Mounting rail insert 16-8G W	\$131.35	68-1155 Latch Retr. LVR	\$10.18
* 68-0770 Mounting rail insert 16-8G N	\$131.35	68-1163 Pusher bolt	\$19.70
* 68-0771 Mounting rail insert 16-8J W	\$131.35	68-1164 Pusher lever	\$50.30
68-0772 Cylinder Lockdown Filler	\$8.82	68-1166 Activation bolt	\$45.76
* 68-0775 Mtg. Rail E-narrow	\$334.79	68-1168 Active case pivot	\$49.07
* 68-0777 Mtg. Rail G-narrow	\$334.79	68-1170 Outside acuator (LHRB)	\$52.75
* 68-0778 Mtg. Rail F-narrow	\$334.79	68-1171 Outside acuator (RHRB)	\$52.75
* 68-0780 Mtg. Rail E-wide	\$334.79	68-1172 Retractor	\$8.18
* 68-0782 Mtg. Rail G-wide	\$334.79	68-1174 Pusher slide	\$8.82
* 68-0783 Mtg. Rail F-wide	\$334.79	68-1180 Tube support	\$9.85
68-0814 Bushing	\$0.60	68-1182 Center link pin	\$11.08
* 68-0826 Mtg. Rail G-wide/narrow (55-56)	\$460.30	* 68-1183 Inactive OS Front (32D only)	\$97.47
* 68-0828 Mtg. Rail J-wide/narrow (55-56)	\$460.30	68-1184 Guide pin	\$8.82
* 68-0836 Mtg. Rail Insert F-wide	\$90.29	68-1186 Active Outside Front	\$24.43
* 68-0838 Mtg. Rail Insert G-wide	\$90.29	68-1191 Link Pin	\$9.66
* 68-0839 Mtg. Rail Insert J-wide/G-narrow	\$90.29	68-1193 Upper link spring	\$11.08
* 68-0840 Mtg. Rail Insert J-narrow	\$90.29	68-1201 Plug	\$3.68
68-0852 700-4 Cam	\$32.22	68-1208 ET cam (LH)	\$16.84
68-0853 Bracket	\$10.18	68-1209 ET cam (RH)	\$16.84
* 68-0866 Mtg. Rail - 8895E	\$390.54	68-1210 Hairpin	\$1.24
* 68-0868 Mtg. Rail - 8895G	\$390.54	68-1217 Roll pin	\$1.07
68-0888 Bottom Plate	\$13.89	68-1220 Active bolt guide	\$8.59
68-0890 Mounting bracket (RHRB) WD-12-8600	\$38.34	68-1222 Inactive bolt guide	\$6.58
68-0891 Mounting bracket (LHRB) WD-12-8600	\$38.34	68-1224 Center link (LH)	\$51.30
68-0917 Auxiliary Control Plate	\$5.15	68-1225 Center link (RH)	\$51.30
68-0918 Extension Rod	\$26.87	68-1245 Adjustment Tube	\$4.92
68-0933 Mount plate (WD-12-8600)	\$35.71	68-1254 Extension Bracket (700-6)	\$12.12
68-0943 Bracket	\$8.46	68-1255 Cover Plate – PP/PR/SP8600	\$10.86
68-0945 Pivot pin (new style)	\$11.29	68-1256 Adjustment Tube Pin	\$7.19
* 68-0948 Mounting Rail J-Wide	\$292.68	68-1270 Ext. Connector	\$30.78
* 68-0949 Mounting Rail G-Wide	\$292.68	* 68-1317 Pull Lever Cover – LP/LR/LS8600	\$180.64
* 68-0950 Mounting Rail E-Wide	\$292.68	* 68-1319 Mtg. Rail - L	\$390.54
* 68-0952 Mounting Rail F-Wide	\$292.68	* 68-1320 Mtg. Rail - M	\$390.54
* 68-0955 Mounting Rail F-Narrow	\$292.68	* 68-1321 Mtg. Rail - N	\$390.54
* 68-0956 Mounting Rail J-Narrow	\$292.68	* 68-1324 Mtg. Rail Insert - L	\$90.29
* 68-0957 Mounting Rail G-Narrow	\$292.68	* 68-1325 Mtg. Rail Insert - M	\$90.29
* 68-0958 Mounting Rail E-Narrow	\$292.68	* 68-1326 Mtg. Rail Insert - N	\$90.29
* 68-1014 59-8800 Cover (Wide)	\$268.23	68-1363 Center Spring	\$7.56
* 68-1015 59-8816 & 66 LH Cover (Wide)	\$293.52	68-1366 Latchbolt Lift Lever	\$2.86
* 68-1016 59-8816 & 66 RH Cover (Wide)	\$293.52	68-1367 Latchbolt Lift Lever	\$2.86
* 68-1020 59-8800 Cover - Narrow	\$324.28	* 68-1369 Mtg. Rail F-wide/narrow (55-56)	\$460.30
* 68-1028 Push Rail 59-80J	\$320.83	* 68-1373 Mtg. Rail Insert F-narrow	\$90.70
* 68-1029 Push Rail 59-80G	\$348.68	* 68-1375 Mtg. Rail Insert E/F-Narrow	\$90.29
* 68-1030 Push Rail 59-80F	\$306.86	* 68-1376 Mtg. Rail Insert E/F-Narrow (16-)	\$131.35

*Specify hardware or painted finish required. Consult catalog for available finishes.

ED-60 EXIT DEVICES

SARGENT®

PARTS

ASSA ABLOY

USA & Canada Prices Effective May 1, 2021

Part No.	Price	Part No.	Price
* 68-1410 Mtg. Rail L (55-56)	\$460.30	* 68-2291 12-8900 Pack all functions LHRB	\$968.08
* 68-1411 Mtg. Rail M (55-56)	\$460.30	* 68-2292 12-8900 Pack all functions RHRB	\$968.08
* 68-1412 Mtg. Rail N (55-56)	\$460.30	* 68-2298 8900 all functions - LHRB Chassis Pack	\$970.96
* 68-1414 Mtg. Rail - L	\$334.77	* 68-2299 8900 all functions - RHRB Chassis Pack	\$970.96
* 68-1415 Mtg. Rail - M	\$334.77	* 68-2305 8828 Chassis Pack LHRB	\$1,225.66
* 68-1416 Mtg. Rail - N	\$334.77	* 68-2306 8828 Chassis Pack RHRB	\$1,225.66
* 68-1444 Push Rail E (8895)	\$306.86	* 68-2307 8863 Chassis Pack LHRB	\$1,268.56
* 68-1445 Push Rail F/J (8895)	\$320.83	* 68-2308 8863 Chassis Pack RHRB	\$1,268.56
* 68-1446 Push Rail G (8895)	\$362.63	* 68-2313 8816 Chassis Pack LHRB	\$1,587.70
68-1455 Top Rod Adjuster	\$6.16	* 68-2314 8816 Chassis Pack RHRB	\$1,587.70
* 68-1466 Mtg. Rail J-narrow	\$334.77	* 68-2315 8866 Chassis Assy. LHRB	\$1,587.70
* 68-1467 Mtg. Rail J-wide	\$334.77	* 68-2316 8866 Chassis Assy. RHRB	\$1,587.70
* 68-1468 Mtg. Rail - 8895J	\$390.54	68-2326 12-8863 Chassis Assy. less cover LHRB	\$1,325.00
* 68-1469 Mtg. Rail - 8895F	\$390.54	68-2327 12-8863 Chassis Assy. less cover RHRB	\$1,325.00
* 68-1477 Mtg. Rail Insert J/G (8895)	\$90.29	68-2329 12-8828 Chassis Assy. less cover LHRB	\$1,282.10
* 68-1479 Mtg. Rail Insert -L	\$90.29	68-2330 12-8828 Chassis Assy. less cover RHRB	\$1,282.10
* 68-1480 Mtg. Rail Insert - M	\$90.29	* 68-2333 12-8828 Chassis Pack LHRB	\$1,507.46
* 68-1481 Mtg. Rail Insert - N	\$90.29	* 68-2334 12-8828 Chassis Pack RHRB	\$1,507.46
68-1503 LIFT LEVER (8600)	\$17.50	* 68-2335 12-8863 Chassis Pack LHRB	\$1,507.46
68-1644 LIFT LEVER LH	\$60.08	* 68-2336 12-8863 Chassis Pack. RHRB	\$1,507.46
68-1645 LIFT LEVER RH	\$60.08	* 68-2341 12-8816 Chassis Pack LHRB	\$1,816.54
68-1657 Interlocking Shim for FM8700	\$34.01	* 68-2342 12-8816 Chassis Pack RHRB	\$1,816.54
68-1662 Rail shim	\$59.36	* 68-2343 12-8866 Chassis Pack LHRB	\$1,689.51
68-2106 8828 Chassis Assy. less cover LHRB	\$1,056.81	* 68-2344 12-8866 Chassis Pack RHRB	\$1,689.51
68-2107 8828 Chassis Assy. less cover RHRB	\$1,056.81	68-2352 8816 Chassis Assy. less cover LHRB	\$1,408.14
68-2109 8863 Chassis Assy. less cover LHRB	\$795.41	68-2353 8816 Chassis Assy. less cover RHRB	\$1,408.14
68-2110 8863 Chassis Assy. less cover RHRB	\$795.41	68-2409 12-8815 Chassis Assy. less cover LHRB – Old	\$1,116.68
* 68-2113 Screw Pk	\$20.34	68-2410 12-8815 Chassis Assy. less cover RHRB – Old	\$1,116.68
68-2116 Chassis Assy HC 8800	\$421.75	68-2425 12-8816 Chassis Assy. less cover LHRB	\$1,646.60
68-2117 Chassis Assy 12-HC 8800	\$518.45	68-2426 12-8816 Chassis Assy. less cover RHRB	\$1,646.60
* 68-2143 Screw Pk A	\$47.36	68-2443 12-8866 Chassis Assy. less cover LHRB	\$1,455.75
68-2163 8710 Chassis Assy. less cover LHRB	\$907.17	68-2444 12-8866 Chassis Assy. less cover RHRB	\$1,455.75
68-2164 8710 Chassis Assy. less cover RHRB	\$907.17	* 68-2446 8706/8713 Chassis Pack LHRB	\$1,535.99
68-2172 8900 All functions less cover LHRB	\$582.64	* 68-2447 8706/8713 Chassis Pack RHRB	\$1,535.99
68-2173 8900 All functions less cover RHRB	\$582.64	* 68-2448 8715 Chassis Pack LHRB	\$1,389.89
68-2198 Locking slide LHRB (8700)	\$18.89	* 68-2449 8715 Chassis Pack RHRB	\$1,389.89
68-2199 Locking slide RHRB (8700)	\$18.89	* 68-2450 8728 Chassis Pack LHRB	\$1,383.94
68-2201 8706/8713 Chassis Assy. less cov. LHRB	\$1,224.02	* 68-2451 8728 Chassis Pack RHRB	\$1,383.94
68-2202 8706/8713 Chassis Assy. less cov. RHRB	\$1,224.02	* 68-2452 8762/8763 Chassis Pack LHRB	\$1,496.58
68-2204 8762/8763 Chassis Assy. less cov. LHRB	\$1,241.07	* 68-2453 8762/8763 Chassis Pack RHRB	\$1,496.58
68-2205 8762/8763 Chassis Assy. less cov. RHRB	\$1,241.07	* 68-2454 12-8706/12-8713 Chassis Pack LHRB	\$1,682.35
68-2207 8715 Chassis Assy. less cover LHRB	\$1,146.05	* 68-2455 12-8706/12-8713 Chassis Pack RHRB	\$1,682.35
68-2208 8715 Chassis Assy. less cover RHRB	\$1,146.05	* 68-2456 12-8715 Chassis Pack LHRB	\$1,679.02
68-2210 8728 Chassis Assy. less cover LHRB	\$1,128.78	* 68-2457 12-8715 Chassis Pack RHRB	\$1,679.02
68-2211 8728 Chassis Assy. less cover RHRB	\$1,128.78	* 68-2458 12-8728 Chassis Pack LHRB	\$1,609.24
68-2213 8916/8966 Chassis Assy. less cov. LHRB	\$741.07	* 68-2459 12-8728 Chassis Pack RHRB	\$1,609.24
68-2214 8916/8966 Chassis Assy. less cov. RHRB	\$741.07	* 68-2460 12-8762/12-8763 Chassis Pack LHRB	\$1,721.93
68-2216 8866 Chassis Assy. LHRB (Less Cover)	\$1,119.18	* 68-2461 12-8762/12-8763 Chassis Pack RHRB	\$1,721.93
68-2217 8866 Chassis Assy. RHRB (Less Cover)	\$1,119.18	* 68-2463 8916/8966 Chassis Pack LHRB	\$1,013.86
* 68-2262 12-8710 Chassis Pack LHRB	\$1,442.82	* 68-2464 8916/8966 Chassis Pack RHRB	\$1,013.86
* 68-2263 12-8710 Chassis Pack RHRB	\$1,442.82	* 68-2466 12-8916/12-8966 Chassis Pack LHRB	\$1,055.74
* 68-2268 8710 Chassis Pack LHRB	\$1,146.05	* 68-2467 12-8916/12-8966 Chassis Pack RHRB	\$1,055.74
* 68-2269 8710 Chassis Pack RHRB	\$1,146.05	68-2481 8300 Chassis Assy. less cover LHRB	\$802.07
* 68-2274 Standard screw pack 12-8700	\$34.08	68-2482 8300 Chassis Assy. less cover RHRB	\$802.07

*Specify hardware or painted finish required. Consult catalog for available finishes.

Experience a safer
and more open world

Copyright © 2002-2021 Sargent Manufacturing Company, an ASSA ABLOY Group company. All rights reserved.
Reproduction in whole or in part without the express written permission of Sargent Manufacturing Company is prohibited.
Contact us at: 800-727-5477 or visit www.sargentlock.com. In Canada contact us at: 800-461-3007 or visit www.assaabloydss.ca

USA & Canada Prices Effective May 1, 2021

Part No.	Price	Part No.	Price
* 68-2486	8300 all functions Chassis Pack LHRB \$1,077.68	* 68-2807	16-55 Rail Assy. G- Narrow \$1,682.35
* 68-2487	8300 all functions Chassis Pack RHRB \$1,077.68	* 68-2808	16-55 Rail Assy. J- Narrow \$1,682.35
* 68-2524	12-8300 Chassis Pack LHRB \$1,182.56	* 68-2809	12-55 Rail Assy. E- Narrow \$1,511.78
* 68-2525	12-8300 Chassis Pack RHRB \$1,182.56	* 68-2810	12-55 Rail Assy. F- Narrow \$1,511.78
68-2594	8600 Chassis Assy. less cover LHRB – Old \$555.26	* 68-2811	12-55 Rail Assy. G- Narrow \$1,511.78
68-2595	8600 Chassis Assy. less cover RHRB – Old \$555.26	* 68-2812	12-55 Rail Assy J- Narrow \$1,511.78
68-2596	Dogging kit \$29.33	* 68-2815	Cam 57-86/87/88/89 Rail Assy. F- Wide (36") \$2,096.89
68-2597	Bridge rectifier pack \$29.33	* 68-2817	Cam 57-86/87/88/89 Rail Assy. G- Wide \$2,096.89
* 68-2694	Rail Assy. wide cam lockdown "E" (24" - 32") \$1,109.33	* 68-2818	Cam 57-86/87/88/89 Rail Assy. J- Wide \$2,096.89
* 68-2695	Rail Assy. wide cam lockdown "F" (33" - 36") \$1,109.33	* 68-2823	12-57-86/87/88/89 Rail Assy. F- Wide (36") \$2,072.47
* 68-2696	Rail Assy. wide cam lockdown "G" (43" - 48") \$1,109.33	* 68-2825	12-57-86/87/88/89 Rail Assy. G- Wide \$2,072.47
* 68-2697	Rail Assy. Wide cam lockdown "J"(37" - 42") \$1,109.33	* 68-2826	12-57-86/87/88/89 Rail Assy. J- Wide \$2,072.47
* 68-2698	16-Rail Assy. wide "E" (28" - 32") \$1,267.97	* 68-2827	57-83/84/85 Rail Assy. E- Narrow (32") \$2,096.89
* 68-2699	16- Rail Assy. wide "F" (33" - 36") \$1,267.97	* 68-2828	57-84/85 Rail Assy. F- Narrow \$2,096.89
* 68-2700	16- Rail Assy. wide "G" (43" - 48") \$1,267.97	* 68-2829	57-83/84/85 Rail Assy. G- Narrow \$2,096.89
* 68-2701	16- Rail Assy. Wide "J" (37" - 42") \$1,267.97	* 68-2830	57-83/84/85 Rail Assy. J- Narrow \$2,096.89
* 68-2702	12-Rail Assy. wide "E" (24" - 32") \$1,109.33	* 68-2835	12-57 83/84/85 Rail Assy E Narrow \$2,072.47
* 68-2703	12- Rail Assy. "F" (33" - 36") \$1,109.33	* 68-2836	12-57 83/84/85 Rail Assy F Narrow \$2,072.47
* 68-2704	12- Rail Assy. "G" (43" - 48") \$1,109.33	* 68-2837	12-57-83/84/85 Rail Assy. G- Narrow \$2,072.47
* 68-2705	12- Rail Assy. "J" (37" - 42") \$1,109.33	* 68-2838	12-57-83/84/85 Rail Assy. J- Narrow \$2,072.47
* 68-2706	Dummy Rail Assy. "E" \$541.40	* 68-2905	19-Rail Assy. "E" Narrow (24" - 32") \$1,080.77
* 68-2707	Dummy Rail Assy. "F" \$541.40	* 68-2906	19- Rail Assy. "F" Narrow (33" - 36") \$1,080.77
* 68-2708	Dummy Rail Assy. "G" \$541.40	* 68-2907	19- Rail Assy. "G" Narrow (43" - 48") \$1,080.77
* 68-2716	Rail Assy. narrow cam lockdown "E" \$1,109.33	* 68-2908	19- Rail Assy. "J" Narrow (37" - 42") \$1,080.77
* 68-2717	Rail Assy. narrow cam lockdown "F" \$1,109.33	* 68-2909	16-19- Rail Assy. "E" Narrow (26" - 32") \$1,243.53
* 68-2718	Rail Assy. narrow cam lockdown "G" \$1,109.33	* 68-2910	16-19- Rail Assy. "F" Narrow (33" - 36") \$1,243.53
* 68-2719	Rail Assy. Narrow cam lockdown "J" \$1,109.33	* 68-2911	16-19- Rail Assy. "G" Narrow (43" - 48") \$1,243.53
* 68-2720	16-Rail Assy. narrow "E" (26" - 32") \$1,267.97	* 68-2912	16-19- Rail Assy. "J" Narrow (37" - 42") \$1,243.53
* 68-2721	16- Rail Assy. narrow "F" (33" - 36") \$1,267.97	* 68-2913	12-19- Rail Assy. "E" Narrow (24" - 32") \$1,079.97
* 68-2722	16- Rail Assy. narrow "G" (43" - 48") \$1,267.97	* 68-2914	12-19- Rail Assy. "F" Narrow (33" - 36") \$1,079.97
* 68-2723	16- Rail Assy "J" Narrow (37" - 42") \$1,267.97	* 68-2915	12-19- Rail Assy. "G" Narrow (43" - 48") \$1,079.97
* 68-2724	12-Rail Assy. narrow "E" (24" - 32") \$1,109.33	* 68-2916	12-19- Rail Assy. "J" Narrow (37" - 42") \$1,079.97
* 68-2725	12- Rail Assy. "F" narrow (33" - 36") \$1,109.33	* 68-2918	19- Rail Assy. "E" Wide (24" - 32") \$1,079.97
* 68-2726	12- Rail Assy. "G" narrow (43" - 48") \$1,109.33	* 68-2919	19- Rail Assy. "F" Wide (33" - 36") \$1,079.97
* 68-2727	12- Rail Assy. "J" narrow (37" - 42") \$1,109.33	* 68-2920	19- Rail Assy. "G" Wide (43" - 48") \$1,079.97
* 68-2757	Mtg. Rail Insert - E-55-8895 \$90.29	* 68-2921	19- Rail Assy. "J" Wide (37" - 42") \$1,079.97
* 68-2789	55-86/87/88/89 Rail Assy. E- Wide \$1,535.99	* 68-2922	16-19- Rail Assy. "E" Wide (28" - 32") \$1,243.53
* 68-2790	55-86/87/88/89 Rail Assy. F- Wide \$1,535.99	* 68-2923	16-19- Rail Assy. "F" Wide (33" - 36") \$1,243.53
* 68-2791	55-86/87/88/89 Rail Assy. G- Wide \$1,535.99	* 68-2924	16-19- Rail Assy. "G" Wide (43" - 48") \$1,243.53
* 68-2792	55-86/87/88/89 Rail Assy J-wide \$1,535.99	* 68-2925	16-19- Rail Assy. "J" Wide (37" - 42") \$1,243.53
* 68-2793	16-55-86/87/88/89 Rail Assy. E-wide \$1,682.93	* 68-2926	12-19- Rail Assy. "E" Wide (24" - 32") \$1,082.56
* 68-2794	16-55-86/87/88/89 Rail Assy. F- Wide \$1,682.93	* 68-2927	12-19- Rail Assy. "F" Wide (33" - 36") \$1,082.56
* 68-2795	16-55-86/87/88/89 Rail Assy. G- Wide \$1,682.93	* 68-2928	12-19- Rail Assy. "G" Wide (43" - 48") \$1,082.56
* 68-2796	16-55-86/87/88/89 Rail Assy. J-wide \$1,682.93	* 68-2929	12-19- Rail Assy. "J" Wide (37" - 42") \$1,082.56
* 68-2797	12-55-86/87/88/89 Rail Assy. E- Wide \$1,511.78	* 68-2941	55-12-19-8G Rail Assy - Wide \$1,426.18
* 68-2798	12-55-86/87/88/89 Rail Assy. F- Wide \$1,511.78	* 68-2942	55-12-19-8J Rail Assy - Wide \$1,426.18
* 68-2799	12-55-86/87/88/89 Rail Assy. G- Wide \$1,511.78	* 68-2943	55-19-8E Rail Assy - Narrow \$1,535.99
* 68-2800	12-55-86/87/88/89 Rail Assy. J-Wide \$1,511.78	* 68-2944	55-19-8F Rail Assy - Narrow \$1,535.99
* 68-2801	55-83/84/85 Rail Assy. E- Narrow \$1,535.99	* 68-2977	Rail Assy Cam Lockdown 8E \$2,096.89
* 68-2802	55-83/84/85 Rail Assy. F- Narrow \$1,535.99	* 68-2978	Rail Assy Cam Lockdown 8F \$2,096.89
* 68-2803	55-83/84/85 Rail Assy. G- Narrow \$1,535.99	* 68-2979	Rail Assy Cam Lockdown 8G \$2,096.89
* 68-2804	55- 83/84-85 Rail Assy. J- Narrow \$1,535.99	* 68-2980	Rail Assy Cam Lockdown 8J \$2,096.89
* 68-2805	16-55 Rail Assy. E- Narrow \$1,682.35	* 68-2977	19-57 Rail Assy E Narrow \$2,096.89
* 68-2806	16-55 Rail Assy. F- Narrow \$1,682.35	* 68-2978	19-57 Rail Assy F Narrow \$2,096.89

*Specify hardware or painted finish required. Consult catalog for available finishes.

ED-62 EXIT DEVICES

SARGENT®

PARTS

ASSA ABLOY

USA & Canada Prices Effective May 1, 2021

Part No.	Price	Part No.	Price		
* 68-2979	19-57 Rail Assy G Narrow	\$2,096.89	* 68-3094	8E Rail Assy (FIRE EX) Wide	\$1,887.17
* 68-2980	19-57 Rail Assy J Narrow	\$2,096.89	* 68-3095	8F Rail Assy (FIRE EX) Wide	\$1,887.17
* 68-3023	Screw Pack for 12-8700	\$121.08	* 68-3096	8G Rail Assy (FIRE EX) Wide	\$1,887.17
68-3026	Screw Pack for wood door 12-8700	\$67.78	* 68-3097	8J Rail Assy (FIRE EX) Wide	\$1,887.17
68-3033	Switch and plate assy (55-80)	\$241.77	* 68-3098	8E Narrow Rail Assy (Cam Dog)	\$1,682.35
* 68-3036	58-86/87/88/89 Rail Assy. E	\$1,682.35	* 68-3099	8F Narrow Rail Assy (Cam Dog)	\$1,682.35
* 68-3037	58-86/87/88/89 Rail Assy. F	\$1,682.35	* 68-3100	8G Narrow Rail Assy (Cam Dog)	\$1,682.35
* 68-3038	58-86/87/88/89 Rail Assy. G	\$1,682.35	* 68-3101	8J Narrow Rail Assy (Cam Dog)	\$1,682.35
* 68-3039	58-86/87/88/89 Rail Assy J	\$1,682.35	* 68-3149	Center case pack (LHRB) 10 & 40 function	\$1,026.21
* 68-3040	16-58-86/87/88/89 Rail Assy E-Wide	\$1,828.65	* 68-3150	Center case pack (RHRB) 10 & 40 function	\$1,026.21
* 68-3041	16-58-86/87/88/89 Rail Assy. F- Wide	\$1,828.65	* 68-3153	Center case pack (LHRB) 28 function	\$1,026.21
* 68-3042	16-58-86/87/88/89 Rail Assy. G- Wide	\$1,828.65	* 68-3154	Center case pack (RHRB) 28 function	\$1,026.21
* 68-3043	16-58-86/87/88/89 Rail Assy J-Wide	\$1,828.65	* 68-3211	56-86/87/88/89 Rail Assy. G- Wide	\$2,316.30
* 68-3044	12-58-86/87/88/89 Rail Assy. E- Wide	\$1,657.87	* 68-3212	56-86/87/88/89 Rail Assy. F- Wide	\$2,316.30
* 68-3045	12-58-86/87/88/89 Rail Assy. F- Wide	\$1,657.87	* 68-3213	56-86/87/88/89 Rail Assy. J- Wide	\$2,316.30
* 68-3046	12-58-86/87/88/89 Rail Assy. G- Wide	\$1,657.87	* 68-3216	56-83/84/85 Rail Assy. G- Narrow	\$2,316.30
* 68-3047	12-58-86/87/88/89 Rail Assy J-Wide	\$1,657.87	* 68-3217	56-83/84/85 Rail Assy. F- Narrow	\$2,316.30
* 68-3048	58-83/84/85 Rail Assy. E- Narrow	\$1,682.35	* 68-3218	56-83/84/85 Rail Assy. J- Narrow	\$2,316.30
* 68-3049	58-83/84/85 Rail Assy. F- Narrow	\$1,682.35	* 68-3224	19-56- 8G Wide Rail	\$2,316.30
* 68-3050	58-83/84/85 Rail Assy. G- Narrow	\$1,682.35	* 68-3225	19-56- 8F Wide Rail	\$2,316.30
* 68-3051	58- 83/84/85 Rail Assy J- Narrow	\$1,682.35	* 68-3226	19-56- 8J Wide Rail	\$2,316.30
* 68-3052	16-58 83-84-85 Rail Assy E- Narrow	\$1,828.65	* 68-3229	19-56-8G Narrow Rail	\$2,316.30
* 68-3053	16-58-83/84/85 Rail Assy. F- Narrow	\$1,828.65	* 68-3230	19-56-8F Narrow Rail	\$2,316.30
* 68-3054	16-58-83/84/85 Rail Assy. G- Narrow	\$1,828.65	* 68-3231	19-56-8J Narrow Rail	\$2,316.30
* 68-3055	16-58 83-84-85 Rail Assy J- Narrow	\$1,828.65	68-3233	MTG PLTE PACK 12-43-56-80	\$76.56
* 68-3056	12-58-83/84/85 Rail Assy. E- Narrow	\$1,657.87	* 68-3277	Active Dummy Rail "E"	\$536.53
* 68-3057	12-58-83/84/85 Rail Assy. F- Narrow	\$1,657.87	* 68-3278	Active Dummy Rail "F"	\$536.53
* 68-3058	12-58-83/84/85 Rail Assy. G- Narrow	\$1,657.87	* 68-3279	Active Dummy Rail "G"	\$536.53
* 68-3059	12-58-83/84/85 Rail Assy. J- Narrow	\$1,657.87	* 68-3281	55-Active Dummy Rail E	\$856.82
* 68-3061	55-58 Rail Assy E-Wide	\$2,466.84	* 68-3282	55-Active Dummy Rail F	\$856.82
* 68-3062	55-58 Rail Assy F-Wide	\$2,466.84	* 68-3283	55-Active Dummy Rail G	\$856.82
* 68-3063	55-58 Rail Assy G-Wide	\$2,466.84	68-3292	Connect Arm assy (55-56-80)	\$51.30
* 68-3064	55-58 Rail Assy J-Wide	\$2,466.84	* 68-3298	55-56-86/87/88/89 Rail Assy. G- Wide	\$2,560.08
* 68-3065	16-55-58 Rail Assy E-Wide	\$2,546.53	* 68-3299	55-56-86/87/88/89 Rail Assy. F- Wide	\$2,560.08
* 68-3066	16-55-58 Rail Assy F-Wide	\$2,546.53	* 68-3300	55-56-86/87/88/89 Rail Assy. J- Wide	\$2,560.08
* 68-3067	16-55-58 Rail Assy G-Wide	\$2,546.53	* 68-3303	55-56-83/84/85 Rail Assy. G- Narrow	\$2,560.08
* 68-3068	16-55-58 Rail Assy J-Wide	\$2,546.53	* 68-3304	55-56-83/84/85 Rail Assy. F- Narrow	\$2,560.08
* 68-3069	12-55-58 Rail Assy E-Wide	\$2,466.84	* 68-3305	55-56-83/84/85 Rail Assy. J- Narrow	\$2,560.08
* 68-3070	12-55-58 Rail Assy F-Wide	\$2,466.84	* 68-3309	19-55-56-80 Rail -G Wide	\$2,560.08
* 68-3071	12-55-58 Rail Assy G-Wide	\$2,466.84	* 68-3310	19-55-56-80 Rail -F Wide	\$2,560.08
* 68-3072	12-55-58 Rail Assy J-Wide	\$2,466.84	* 68-3311	19-55-56-80 Rail -J Wide	\$2,560.08
* 68-3073	55-58 Rail Assy E-narrow	\$2,466.84	* 68-3314	19-55-56-80 Rail -G Narrow	\$2,560.08
* 68-3074	55-58 Rail Assy F-narrow	\$2,466.84	* 68-3315	19-55-56-80 Rail -F Narrow	\$2,560.08
* 68-3075	55-58 Rail Assy G-narrow	\$2,466.84	* 68-3316	19-55-56-80 Rail -J Narrow	\$2,560.08
* 68-3076	55-58 Rail Assy J-narrow	\$2,466.84	68-3514	WD-12-8600 Inner case package K	\$201.55
* 68-3077	16-55-58 Rail Assy E-narrow	\$2,546.53	68-3522	WD CVR Top Case/Bracket assy 1 3/4" door	\$345.60
* 68-3078	16-55-58 Rail Assy F-narrow	\$2,546.53	68-3523	WD CVR Top Case/Bracket assy 1 3/4" Door 1/4" cladding	\$345.60
* 68-3079	16-55-58 Rail Assy G-narrow	\$2,546.53	68-3524	WD CVR Top Case/Bracket assy 1 3/4" door 1/2" cladding	\$345.60
* 68-3080	16-55-58 Rail Assy J-narrow	\$2,546.53	68-3563	Top & Bottom Case Pk.	\$415.92
* 68-3081	12-55-58 Rail Assy E-narrow	\$2,466.84	68-3577	Screw pack	\$18.29
* 68-3082	12-55-58 Rail Assy F-narrow	\$2,466.84	68-3580	Inner chassis assy. 700-4 ET and Control	\$283.08
* 68-3083	12-55-58 Rail Assy G-narrow	\$2,466.84			
* 68-3084	12-55-58 Rail Assy J-narrow	\$2,466.84			

*Specify hardware or painted finish required. Consult catalog for available finishes.

Experience a safer
and more open world

Copyright © 2002-2021 Sargent Manufacturing Company, an ASSA ABLOY Group company. All rights reserved.
Reproduction in whole or in part without the express written permission of Sargent Manufacturing Company is prohibited.
Contact us at: 800-727-5477 or visit www.sargentlock.com. In Canada contact us at: 800-461-3007 or visit www.assaabloydss.ca

USA & Canada Prices Effective May 1, 2021

Part No.	Price	Part No.	Price		
68-3627	Inner case assy. ET & 100 Aux Control	\$397.35	68-3827	12-59 & 59-8762/63 Chas Assy R	\$1,701.84
68-3671	Locking Clip - Adapter Assy	\$31.23	68-3829	12-59 & 59-8728 Chas Assy L	\$1,589.76
* 68-3674	MD-12-8400 CC PK LHRB	\$1,026.17	68-3830	12-59 & 59-8728 Chas Assy R	\$1,589.76
* 68-3675	MD-12-8400 CC PK RHRB	\$1,026.17	68-3833	59-28 LHRB Chassis Assy	\$1,514.06
* 68-3676	SCREW PACK (MD-12-8400)	\$11.25	68-3834	59-28 RHRB Chassis Assy	\$1,514.06
68-3677	SCREW PACK (MD-12-8600)	\$18.29	68-3835	12-59-28 LH Chassis Assy	\$1,693.53
* 68-3678	MD-12-8600 Chassis pack	\$822.17	68-3836	12-59-28 RH Chassis Assy	\$1,693.53
68-3714	Chassis Assy. 12-59-8706 LHR	\$1,255.22	68-3842	12-59-80 Screw Pack	\$15.01
68-3715	Chassis Assy. 12-59-8706 RHR	\$1,255.22	* 68-3844	12-59-8706/13 CC PK LH	\$1,666.96
68-3717	Chassis Assy. 12-59 & 59 8715 LH	\$1,589.76	* 68-3846	12-59&59-8715,73&74 CC LH	\$1,856.17
68-3718	Chassis Assy. 12-59 & 59 8715 RH	\$1,589.76	* 68-3847	12-59&59-8715,73&74 CC RH	\$1,856.17
* 68-3751	59-8804 CC Pk L	\$1,792.11	* 68-3850	12-59-8762/63 CC PK LH	\$1,666.96
* 68-3757	59-8816 CC PK LH	\$1,792.12	* 68-3851	12-59&59-8762/63 CC PK RH	\$1,666.96
* 68-3758	59-8816 CC PK RH	\$1,792.12	* 68-3852	12-59&59-8710 CC PK LH	\$1,666.96
* 68-3759	C/C PACK LH (59-63)	\$1,792.12	* 68-3853	12-59&59-8710 CC PK RH	\$1,666.96
* 68-3760	59-8863 CC pk (RH)	\$1,792.12	68-3854	MD-59-8600 Inner Case	\$390.15
* 68-3761	59-8866 CC PK (LH)	\$1,792.12	68-3855	MD-12-59-8600 Inner case	\$486.48
* 68-3762	59-8866 CC PK (RH)	\$1,792.12	68-3859	WD-59-8600 Inner case PKR	\$367.87
* 68-3765	12-59-8804,10,13,15,40,43	\$1,848.19	* 68-3873	59-8400 C-CASE PK - LH	\$1,792.12
* 68-3771	12-59-8816 CC PK LH	\$1,848.19	* 68-3874	59-8400 C-CASE PK - RH	\$1,792.12
* 68-3772	12-59-8816 CC PK RH	\$1,848.19	* 68-3876	Mfg. Rail Insert G- Wide	\$131.35
* 68-3773	12-59-8863 CC PK LH	\$1,848.19	* 68-3877	Mtg. Rail Insert - G-narrow	\$131.35
* 68-3774	12-59-8863 CC PK RH	\$1,848.19	* 68-3878	Mtg. Rail Insert - J-narrow	\$131.35
* 68-3775	12-59-8866 CC PK LH	\$1,848.19	* 68-3879	Mtg. Rail Insert - 8J narrow	\$131.35
* 68-3776	12-59-8866 CC PK RH	\$1,848.19	68-3881	59-8904 thru 76 Chassis Assy - LH	\$204.82
* 68-3780	59-86/87/88/89 Rail Assy. F-Wide	\$3,145.25	68-3882	59-8904 thru 76 Chassis Assy - RH	\$204.82
* 68-3781	59-86/87/88/89 Rail Assy. J-Wide	\$3,145.25	* 68-3887	59-8900 Center Case Pak - LH	\$588.62
* 68-3782	59-86/87/88/89 Rail Assy. G-Wide	\$3,145.25	* 68-3888	59-8900 Center Case Pak - RH	\$588.62
* 68-3784	12-59-86/87/88/89 Rail Assy. F-Wide	\$3,120.83	* 68-3905	Screw Pak	\$7.39
* 68-3785	12-59-86/87/88/89 Rail Assy. J-Wide	\$3,120.83	68-3906	Screw Pk B	\$42.92
* 68-3786	12-59-86/87/88/89 Rail Assy. G-Wide	\$3,120.83	68-3917	12-HC-8804 Chas Assy. - Old Style	\$1,316.61
* 68-3788	Cam 59-83/84/85 F-Narrow	\$3,145.25	68-3918	HC-8804 Chas Assy. - Old Style	\$1,097.21
* 68-3789	Cam 59-83/84/85 J-Narrow	\$3,145.25	68-3921	HC-8800 Center Case	
* 68-3790	Cam 59-83/84/85 G-Narrow	\$3,145.25		Pk - 04,10,13,15,40,43,44 functions	\$1,148.40
* 68-3792	12-59-83/84/85 Rail Assy. F-Narrow	\$3,120.83	68-3922	Screw Pak (12-8800)	\$17.51
* 68-3793	12-59-83/84/85 Rail Assy. J-Narrow	\$3,120.83	68-3931	PP,PR,SP&12-8700 Chassis Assy LH	\$245.65
* 68-3794	12-59-83/84/85 Rail Assy. G-Narrow	\$3,120.83	68-3932	12-8700 Chassis Assy. RHR	\$245.65
* 68-3797	19-59 Rail Assy 8F Wide	\$3,145.25	68-3933	PP/PR/SP Top case	\$280.79
* 68-3798	19-59 Rail Assy 8J Wide	\$3,145.25	68-3934	Active Mortise Case - PP/SP8700	\$645.24
* 68-3799	19-59 Rail Assy 8G Wide	\$3,145.25	68-3935	Inactive Mortise Case - PR8700	\$512.08
* 68-3801	12-19-59 Rail Assy 8F Wide	\$3,120.83	68-3940	PP & PP12-8700 Lockbody Assy	\$698.35
* 68-3802	12-19-59 Rail Assy 8J Wide	\$3,120.83	68-3941	PR&PR12-8700 Lockbody Assy	\$433.99
* 68-3803	12-19-59 Rail Assy 8G Wide	\$3,120.83	68-3945	Active latchbolt assembly	\$195.00
* 68-3805	19-59 Rail Assy 8F Narrow	\$3,145.25	* 68-3953	PP/PR/SP8700 T/C Pack	\$564.42
* 68-3806	19-59 Rail Assy 8J Narrow	\$3,145.25	* 68-3954	PP/PR/SP8700 T/C Pack	\$564.42
* 68-3807	19-59 Rail Assy 8G Narrow	\$3,145.25	68-3956	Pusher rod assembly	\$47.82
* 68-3809	12-19-59 Rail Assy 8F Narrow	\$3,120.83	* 68-3973	CC PK AL/GL-8804/10 LH	\$680.91
* 68-3810	12-19-59 Rail Assy 8J Narrow	\$3,120.83	* 68-3989	CC PK 12AL/12GL 8804/10	\$752.01
* 68-3811	12-19-59 Rail Assy 8G Narrow	\$3,120.83	* 68-4010	AL- "8F" Wide Rail Assy.	\$1,779.85
68-3814	Screw Pack (MD-8600)	\$19.50	* 68-4011	AL- "8J" Wide Rail Assy.	\$1,779.85
* 68-3815	MD- 8600 Chas Pack	\$707.04	* 68-4012	AL- "8G" Wide Rail Assy.	\$1,779.85
68-3823	12-59 & 59-8710 Chas Assy LHR	\$1,367.92	* 68-4018	AL-12- "8F" Wide Rail Assy.	\$1,779.85
68-3824	12-59 & 59-8710 Chas Assy RHR	\$1,367.92	* 68-4019	AL-12- "8J" Wide Rail Assy.	\$1,779.85
68-3826	12-59 & 59-8762/63 Chas Assy L	\$1,701.84	* 68-4020	AL-12- "8G" Wide Rail Assy.	\$1,779.85

*Specify hardware or painted finish required. Consult catalog for available finishes.

ED-64 EXIT DEVICES

SARGENT®

ASSA ABLOY

PARTS

USA & Canada Prices Effective May 1, 2021

Part No.	Price	Part No.	Price
* 68-4022 AL- "8F" Nar Rail Asy.	\$1,779.85	68-4235 16 Function Lever Asy RHR 80 Ser.	\$219.41
* 68-4023 AL- "8J" Nar Rail Asy.	\$1,779.85	68-4236 16 Function Lever Asy LHR 80 Ser.	\$219.41
* 68-4024 AL- "8G" Nar Rail Asy.	\$1,779.85	68-4238 Inactive mortise case	\$646.10
* 68-4025 AL- 8E Nar Rail. Asy.	\$1,779.85	68-4239 Active mortise case	\$889.91
* 68-4030 AL-12- "8F" Nar Rail Asy.	\$1,779.85	* 68-4242 L Low Profile Rail (36") (Cam)	\$1,219.11
* 68-4031 AL-12- "8J" Nar Rail Asy.	\$1,779.85	* 68-4243 M Low Profile Rail (42" or 44")	\$1,219.11
* 68-4032 AL-12- "8G" Nar Rail Asy.	\$1,779.85	* 68-4244 N Low Profile Rail (46" or 48")	\$1,219.11
* 68-4033 AL-12 8E Nar Rail Assy	\$1,779.85	* 68-4246 L 16- Low Profile Rail (36")	\$1,377.55
* 68-4035 AL-19- "8F" Wide Rail Asy.	\$1,750.50	* 68-4247 M 16- Low Profile Rail (42" or 44")	\$1,377.55
* 68-4036 AL-19- "8J" Wide Rail Asy.	\$1,750.50	* 68-4248 N 16- Low Profile Rail (46" or 48")	\$1,377.55
* 68-4037 AL-19- "8G" Wide Rail Asy.	\$1,750.50	* 68-4250 L 12- Low Profile Rail (36")	\$1,219.11
* 68-4043 AL-12-19- "8F" Wide Rail Asy.	\$1,753.00	* 68-4251 M 12- Low Profile Rail (42" or 44")	\$1,219.11
* 68-4044 AL-12-19- "8J" Wide Rail Asy.	\$1,753.00	* 68-4252 N 12- Low Profile Rail (46" or 48")	\$1,219.11
* 68-4045 AL-12-19- "8G" Wide Rail Asy.	\$1,753.00	* 68-4255 Mtg. Rail Insert - L	\$131.35
* 68-4047 AL-19- "8F" Nar Rail Asy.	\$1,750.50	* 68-4256 Mtg. Rail Insert - M	\$131.35
* 68-4048 AL-19- "8J" Nar Rail Asy.	\$1,750.50	* 68-4257 Mtg. Rail Insert - N	\$131.35
* 68-4049 AL-19- "8G" Nar Rail Asy.	\$1,750.50	68-4261 Chassis Asy 8800	\$493.01
* 68-4050 AL-19- "8E" Nar Rail Asy. 32" only	\$1,750.50	68-4263 12-8888 CHASSIS ASY	\$503.37
* 68-4055 AL-12-19- "8F" Nar Rail Asy.	\$1,750.50	68-4264 Chassis Asy LP/LR/LS + 12-8600	\$553.52
* 68-4056 AL-12-19- "8J" Nar Rail Asy.	\$1,750.50	68-4270 Upper Link asy LH	\$69.80
* 68-4057 AL-12-19- "8G" Nar Rail Asy.	\$1,750.50	68-4271 Upper Link asy RH	\$69.80
68-4075 Chassis Asy AL-8816 LH	\$1,188.16	* 68-4296 16-19 L RL LOW PROFILE	\$1,377.54
68-4076 Chassis Asy AL-8816 RH	\$1,188.16	* 68-4297 16-19 M RL LOW PROFILE	\$1,377.54
68-4077 Chassis Asy AL-12-8816 LH	\$895.12	* 68-4298 16-19 N RL LOW PROFILE	\$1,377.54
68-4078 Chassis Asy AL-12-8816 RH	\$895.12	* 68-4305 55-Low Profile Rail Asy - L - (36")	\$1,538.27
68-4080 Chassis Asy AL-8828 LH	\$654.70	* 68-4306 55-Low Profile Rail Asy - M - (42" or 44")	\$1,538.27
68-4081 Chassis Asy AL-8828 RH	\$654.70	* 68-4307 55-Low Profile Rail Asy - N - (46" or 48")	\$1,538.27
68-4082 Chassis Asy AL-12-8828 LH	\$925.62	* 68-4309 12-55-Low Profile Rail Asy - L - (36")	\$1,538.27
68-4083 Chassis Asy AL-12-8828 RH	\$925.62	* 68-4310 12-55-Low Profile Rail Asy - M - (42" or 44")	\$1,538.27
68-4097 CHASSIS ASY AL-8863 LH	\$1,304.90	* 68-4311 12-55-Low Profile Rail Asy - N - (46" or 48")	\$1,538.27
68-4098 CHASSIS ASY AL-8863 RH	\$1,304.90	* 68-4322 55-56-Low Profile Rail Asy - L - (36")	\$2,494.71
68-4099 CHASSIS ASY AL-12-8863LH	\$1,530.31	* 68-4323 55-56-Low Profile Rail Asy - M - (42" or 44")	\$2,494.71
68-4100 CHASSIS ASY AL-12-8863RH	\$1,530.31	* 68-4324 55-56-Low Profile Rail Asy - N - (46" or 48")	\$2,494.71
68-4102 CHASSIS ASY AL-8866 LH	\$1,324.41	* 68-4331 56-Low Profile Rail Asy - L - (36")	\$2,173.90
68-4103 CHASSIS ASY AL-8866 RH	\$1,324.41	* 68-4332 56-Low Profile Rail Asy - M - (42" or 44")	\$2,173.90
68-4104 CHASSIS ASY AL-12-8866 LH	\$1,660.98	* 68-4333 56-Low Profile Rail Asy - N - (46" or 48")	\$2,173.90
68-4105 CHASSIS ASY AL-12-8866 RH	\$1,660.98	* 68-4335 19-56 "L" RL Low Profile	\$2,173.90
68-4112 CHASSIS ASY AL-8706&13 LH	\$1,501.64	* 68-4336 19-56 "M" RL Low Profile	\$2,173.90
68-4113 CHASSIS ASY AL-8706&13 RH	\$1,501.64	* 68-4337 19-56 "N" RL Low Profile	\$2,173.90
68-4115 Chassis Asy AL-8715,73,74 LH	\$1,351.25	* 68-4340 58-Low Profile Rail Asy - L - (36")	\$1,675.77
68-4116 Chassis Asy AL-8715,73,74 RH	\$1,351.25	* 68-4341 58-Low Profile Rail Asy - M - (42" or 44")	\$1,675.77
68-4118 Chassis Asy AL-8728 LH	\$1,334.03	* 68-4342 58-Low Profile Rail Asy - N - (46" or 48")	\$1,675.77
68-4119 Chassis Asy AL-8728 RH	\$1,334.03	* 68-4344 12-58-Low Profile Rail Asy - L - (36")	\$1,675.77
68-4121 Chassis Asy AL-8762&63LH	\$1,446.31	* 68-4345 12-58-Low Profile Rail Asy - M - (42" or 44")	\$1,675.77
68-4122 Chassis Asy AL-8762&63RH	\$1,446.31	* 68-4346 12-58-Low Profile Rail Asy - N - (46" or 48")	\$1,675.77
68-4124 Chassis Asy AL-8710 LH	\$1,112.39	* 68-4357 55-58-Low Profile Rail Asy - L - (36")	\$1,994.57
68-4125 Chassis Asy AL-8710 RH	\$1,112.39	* 68-4358 55-58-Low Profile Rail Asy - M - (42" or 44")	\$1,994.57
68-4127 Chassis Asy AL-8504,6,13 LH	\$1,394.97	* 68-4359 55-58-Low Profile Rail Asy - N - (46" or 48")	\$1,994.57
68-4128 Chassis Asy AL-8504,6,13 RH	\$1,394.97	* 68-4361 12-55-58-Low Profile Rail Asy - L - (36")	\$1,994.57
68-4129 Chassis Asy AL-8510	\$1,154.65	* 68-4362 12-55-58-Low Profile Rail Asy - M - (42" or 44")	\$1,994.57
68-4180 Active Mort. Case PP/SP8600	\$889.91	* 68-4363 12-55-58-Low Profile Rail Asy - N - (46" or 48")	\$1,994.57
68-4181 Inactive Mort. Case PR8600	\$646.10	68-4373 Screw pack - low profile	\$15.01
68-4209 Extension Rod Assembly 12"	\$79.28	68-4383 Mounting plate pk low pro	\$45.17
68-4210 Extension Rod Assembly 18"	\$81.24	68-4389 SCREW PACK (W)	\$2.03
68-4211 Extension Rod Assembly 24"	\$85.13	* 68-4406 Top & Bottom Pk (12-3700)	\$759.18

*Specify hardware or painted finish required. Consult catalog for available finishes.

Experience a safer
and more open world

Copyright © 2002-2021 Sargent Manufacturing Company, an ASSA ABLOY Group company. All rights reserved.
Reproduction in whole or in part without the express written permission of Sargent Manufacturing Company is prohibited.
Contact us at: 800-727-5477 or visit www.sargentlock.com. In Canada contact us at: 800-461-3007 or visit www.assaabloydss.ca

USA & Canada Prices Effective May 1, 2021

Part No.	Price	Part No.	Price
68-4410 Chassis Asy (AL-/GL-)	\$347.66	* 68-4649 12-53-58 J Wide Rail Assy	\$1,896.54
68-4411 Chassis Asy (12-AL/12-GL)	\$564.42	* 68-4650 12-53-58 G Wide Rail Assy	\$1,896.54
68-4413 Latchbolt Asy - standard	\$29.01	* 68-4651 53-58 E Narrow Rail Assy.	\$1,896.54
68-4415 Latchbolt Asy - Guarded	\$49.38	* 68-4652 53-58 F Narrow Rail Assy.	\$1,896.54
68-4420 Chassis Asy (59-)	\$406.39	* 68-4653 53-58 J Narrow Rail Assy	\$1,896.54
68-4421 Chassis Asy (12-59-)	\$598.29	* 68-4654 53-58 G Narrow Rail Assy	\$1,896.54
* 68-4449 Center Case for 8804,06,10,13,15	\$1,095.91	* 68-4655 16-53-58 E Narrow Rail Assy	\$2,062.31
68-4549 Bottom Case asy (8700)	\$174.44	* 68-4656 16-53-58 F Narrow Rail Assy	\$2,062.31
* 68-4551 8700 TOP/BOTTOM CASE PK	\$718.31	* 68-4657 16-53-58 J Narrow Rail Assy	\$2,062.31
* 68-4552 12-8700 Top/Btm case pk	\$536.63	* 68-4658 16-53-58 G Narrow Rail Assy	\$2,062.31
* 68-4554 14-8700 TOP/BTM CASE PK	\$718.31	* 68-4659 12-53-58 E Narrow Rail Assy	\$1,896.54
* 68-4555 12FM/FM8700 TOP&BOTTOM PK	\$716.67	* 68-4660 12-53-58 F Narrow Rail Assy	\$1,896.54
68-4556 Bottom Case asy (14-8700)	\$123.13	* 68-4661 12-53-58 J Narrow Rail Assy	\$1,896.54
68-4557 TOP CASE ASY (8700)	\$205.25	* 68-4662 12-53-58 G Narrow Rail Assy	\$1,896.54
68-4558 BOTTOM CASE ASY (12-8700)	\$251.33	* 68-4663 53-55-58 E Wide Rail Assy	\$2,215.38
68-4559 TOP CASE ASY (12-8700)	\$302.50	* 68-4664 53-55-58 F Wide Rail Assy	\$2,215.38
68-4561 Top Case Asy (HC8700)	\$246.27	* 68-4665 53-55-58 J Wide Rail Assy	\$2,215.38
68-4568 NB-8700 Chassis Asy (LHR)	\$524.16	* 68-4666 53-55-58 G Wide Rail Assy	\$2,215.38
68-4569 NB-8700 Chassis Asy (RHR)	\$524.16	* 68-4667 16-53-55-58 E Wide Rail Assy	\$2,381.17
* 68-4570 Mtg. Rail Insert -E/F-narrow	\$131.35	* 68-4668 16-53-55-58 F Wide Rail Assy	\$2,381.17
* 68-4572 Mtg. Rail Insert - F-narrow	\$131.35	* 68-4669 16-53-55-58 J Wide Rail Assy	\$2,381.17
* 68-4574 Mtg. Rail Insert - F-55-8895	\$90.70	* 68-4670 16-53-55-58 G Wide Rail Assy	\$2,381.17
* 68-4575 Mtg. Rail Insert -J/G-55-8895	\$90.70	* 68-4671 12-53-55-58 E Wide Rail Assy	\$2,215.38
* 68-4577 NB-8700 (LH) CC PK	\$1,477.69	* 68-4672 12-53-55-58 F Wide Rail Assy	\$2,215.38
* 68-4578 NB-8700 (RH) CC PK	\$1,477.69	* 68-4673 12-53-55-58 J Wide Rail Assy	\$2,215.38
* 68-4579 Active Dummy Rail "J"	\$536.53	* 68-4674 12-53-55-58 G Wide Rail Assy	\$2,215.38
* 68-4580 55-Active Dummy Rail J	\$818.13	* 68-4675 53-55-58 E Narrow Rail Assy	\$2,215.38
* 68-4591 53- E Wide Rail Asy	\$1,406.41	* 68-4676 53-55-58 F Narrow Rail Assy	\$2,215.38
* 68-4592 53- F Wide Rail Asy	\$1,406.41	* 68-4677 53-55-58 J Narrow Rail Assy	\$2,215.38
* 68-4593 53- J Wide Rail Asy	\$1,406.41	* 68-4678 53-55-58 G Narrow Rail Assy	\$2,215.38
* 68-4594 53- G Wide Rail Asy	\$1,406.41	* 68-4679 16-53-55-58 E Narrow Rail Assy	\$2,381.17
* 68-4599 16-53- 8E Wide Rail Asy	\$1,576.78	* 68-4680 16-53-55-58 F Narrow Rail Assy	\$2,381.17
* 68-4600 16-53- 8F Wide Rail Asy	\$1,576.78	* 68-4681 16-53-55-58 J Narrow Rail Assy	\$2,381.17
* 68-4601 16-53- 8J Wide Rail Asy	\$1,576.78	* 68-4682 16-53-55-58 G Narrow Rail Assy	\$2,381.17
* 68-4602 16-53- 8J Wide Rail Asy	\$1,576.78	* 68-4683 12-53-55-58 E Narrow Rail Assy	\$2,215.38
68-4615 53-55 E Wide Rail Assy.	\$1,594.05	* 68-4684 12-53-55-58 F Narrow Rail Assy	\$2,215.38
* 68-4616 53-55 F Wide Rail Assy.	\$1,594.05	* 68-4685 12-53-55-58 J Narrow Rail Assy	\$2,215.38
* 68-4617 53-55 J Wide Rail Assy.	\$1,594.05	* 68-4686 12-53-55-58 G Narrow Rail Assy	\$2,215.38
* 68-4618 53-55 G Wide Rail Assy.	\$1,594.05	* 68-4687 12-53-56 F Wide Rail Assy	\$2,535.74
* 68-4623 12-53-55- 8E Wide Rail Assy	\$1,786.44	* 68-4688 12-53-56 J Wide Rail Assy	\$2,535.74
* 68-4624 12-53-55- 8F Wide Rail Assy	\$1,786.44	* 68-4689 12-53-56 G Wide Rail Assy	\$2,535.74
* 68-4625 12-53-55- 8J Wide Rail Assy	\$1,786.44	* 68-4690 12-53-56 F Narrow Rail Assy	\$2,535.74
* 68-4626 12-53-55- 8G Wide Rail Assy	\$1,786.44	* 68-4691 12-53-56 J Narrow Rail Assy	\$2,535.74
* 68-4628 53-55 Narrow Rail Asy	\$1,689.73	* 68-4692 12-53-56 G Narrow Rail Assy	\$2,535.74
* 68-4639 53-58 E Wide Rail Assy.	\$1,896.54	* 68-4693 12-53-55-56 F Wide Rail Assy	\$2,854.59
* 68-4640 53-58 F Wide Rail Assy.	\$1,896.54	* 68-4694 12-53-55-56 J Wide Rail Assy	\$2,854.59
* 68-4641 53-58 J Wide Rail Assy	\$1,896.54	* 68-4695 12-53-55-56 G Wide Rail Assy	\$2,854.59
* 68-4642 53-58 G Wide Rail Assy	\$1,896.54	* 68-4696 12-53-55-56 F Narrow Rail Assy	\$2,854.59
* 68-4643 16-53-58 E Wide Rail Assy	\$2,062.31	* 68-4697 12-53-55-56 J Narrow Rail Assy	\$2,854.59
* 68-4644 16-53-58 F Wide Rail Assy	\$2,062.31	* 68-4698 12-53-55-56 G Narrow Rail Assy	\$2,854.59
* 68-4645 16-53-58 J Wide Rail Assy	\$2,062.31	* 68-4743 19-53E Narrow Rail	\$1,406.41
* 68-4646 16-53-58 G Wide Rail Assy	\$2,062.31	* 68-4744 19-53F Narrow Rail	\$1,406.41
* 68-4647 12-53-58 E Wide Rail Assy	\$1,896.54	* 68-4745 19-53J Narrow Rail	\$1,406.41
* 68-4648 12-53-58 F Wide Rail Assy	\$1,896.54	* 68-4746 19-53G Narrow Rail	\$1,406.41

*Specify hardware or painted finish required. Consult catalog for available finishes.

ED-66 EXIT DEVICES

SARGENT®

PARTS

ASSA ABLOY

USA & Canada Prices Effective May 1, 2021

Part No.	Price	Part No.	Price		
* 68-4826	19-53-56-8F Wide Rail Assy	\$2,560.08	* 68-5185	TL-59-8J NAR RAIL ASY	\$3,694.81
* 68-4827	19-53-56-8J Wide Rail Assy	\$2,560.08	68-5374	CVR Top Case Assy - 1 3/4" door	\$219.80
* 68-4828	19-53-56-8G Wide Rail Assy	\$2,560.08	68-5375	CVR Top Case Assy - 1 3/4" door 1/4" cladding	\$219.80
* 68-4829	19-53-56-8F Narrow Rail Assy	\$2,560.08	68-5376	CVR Top Case Assy - 1 3/4" door 1/2" cladding	\$219.80
* 68-4830	19-53-56-8J Narrow Rail Assy	\$2,560.08	* 68-5377	MD & 12-MD8600 LH C/C PK	\$1,423.53
* 68-4831	19-53-56-8G Narrow Rail Assy	\$2,560.08	* 68-5378	MD & 12-MD8600 RH C/C PK	\$1,423.53
* 68-4833	Mtg. Rail Insert - F-wide	\$131.35	* 68-5385	WD & 12-WD8600 LH C/C PK	\$525.55
68-4838	Connect Arm & Pin asy.	\$43.09	* 68-5386	WD & 12-WD8600 RH C/C PK	\$525.55
68-4840	Latchbolt Assy - Guarded	\$38.67	* 68-5389	59MD & 1259-MD8600 LH C/C	\$525.55
* 68-4938	55-57 Rail Assy - F-wide	\$2,426.99	* 68-5390	59MD & 1259-MD8600 RH C/C	\$525.55
* 68-4939	55-57 Rail Assy - G-wide	\$2,426.99	68-5420	Chassis mount screw pack	\$5.46
* 68-4940	55-57 Rail Assy - J-wide	\$2,426.99	* 68-5421	Screw Pack J (12- 1-3/4")	\$36.66
* 68-4942	12-55-57 Rail Assy - F-wide	\$2,426.99	* 68-5423	Screw Pack V (PP/PR/NB)	\$20.34
* 68-4943	12-55-57 Rail Assy - G-wide	\$2,426.99	68-5424	Screw Pack - HC8700	\$10.69
* 68-4944	12-55-57 Rail Assy - J-wide	\$2,426.99	68-5447	53-PP,PR,SP chassis assy LH	\$703.54
* 68-4945	55-57 Rail Assy - E-narrow	\$2,426.99	68-5448	53-PP,PR,SP chassis assy RH	\$703.54
* 68-4946	55-57 Rail Assy - F-narrow	\$2,426.99	68-5449	Chassis Assy LH 53-NB	\$649.10
* 68-4947	55-57 Rail Assy - G-narrow	\$2,426.99	68-5450	Chassis Assy RH 53-NB	\$649.10
* 68-4948	55-57 Rail Assy - J-narrow	\$2,426.99	* 68-5462	FM-E Rail Assy	\$1,466.18
* 68-4949	12-55-57 Rail Assy - E-narrow	\$2,426.99	* 68-5463	FM-F Rail Assy	\$1,466.18
* 68-4950	12-55-57 Rail Assy - F-narrow	\$2,426.99	* 68-5464	FM-J Rail Assy	\$1,466.18
* 68-4951	12-55-57 Rail Assy - G-narrow	\$2,426.99	* 68-5465	FM-G Rail Assy	\$1,466.18
* 68-4952	12-55-57 Rail Assy - J-narrow	\$2,426.99	* 68-5466	FM-12-E Rail Assy	\$1,654.61
* 68-4953	19-53-55-56-8F W RAIL	\$2,854.59	* 68-5467	FM-12-F Rail Assy	\$1,654.61
* 68-4954	19-53-55-56-8J Wide Rail Assy	\$2,854.59	* 68-5468	FM-12-J Rail Assy	\$1,654.61
* 68-4955	19-53-55-56-8G Wide Rail Assy	\$2,854.59	* 68-5469	FM-12-G Rail Assy	\$1,654.61
* 68-4956	19-53-55-56-8F Narrow Rail Assy	\$2,854.59	* 68-5487	FM-53-55-F Rail Assy	\$2,010.17
* 68-4957	19-53-55-56-8J Narrow Rail Assy	\$2,854.59	68-5496	Chassis Assy 8800 V.N1	\$447.70
* 68-4958	19-53-55-56-8G Narrow Rail Assy	\$2,854.59	* 68-5514	19-55-56-8E Wide Rail Assy	\$2,349.31
* 68-4976	55-AL Rail Assy - F-wide	\$2,108.17	* 68-5527	19-53-55-56-8E Wide Rail Assy	\$2,854.59
* 68-4977	55-AL Rail Assy - J-wide	\$2,108.17	* 68-5542	56- 8E Wide Rail Assy	\$2,316.30
* 68-4978	55-AL Rail Assy - G-wide	\$2,108.17	* 68-5543	RL/TCH BAR ASY W 55-56-8E	\$2,560.08
* 68-4980	12-55-AL Rail Assy - F-wide	\$2,108.17	* 68-5545	RAIL ASY W 53-55-56-8E	\$2,644.94
* 68-4981	12-55-AL Rail Assy - J-wide	\$2,108.17	* 68-5546	RL/TCH BAR ASY W HK-56-8E	\$2,319.99
* 68-4982	12-55-AL Rail Assy - G-wide	\$2,108.17	* 68-5547	RL/TCH BAR ASY W HK-56-8F	\$2,319.99
* 68-4983	55-AL Rail Assy - E-narrow	\$2,108.17	* 68-5548	RL/TCH BAR ASY W HK-56-8J	\$2,319.99
* 68-4984	55-AL Rail Assy - F-narrow	\$2,108.17	* 68-5549	RL/TCH BAR ASY W HK-56-8G	\$2,319.99
* 68-4985	55-AL Rail Assy - J-narrow	\$2,108.17	* 68-5550	RL/TCH BAR W HK-55-56-8E	\$2,560.10
* 68-4986	55-AL Rail Assy - G-narrow	\$2,108.17	* 68-5551	RL/TCH BAR W HK-55-56-8F	\$2,560.10
* 68-4987	12-55-AL Rail Assy - F-narrow	\$2,108.17	* 68-5552	RL/TCH BAR W HK-55-56-8J	\$2,560.10
* 68-4988	12-55-AL Rail Assy - J-narrow	\$2,108.17	* 68-5553	RL/TCH BAR W HK-55-56-8G	\$2,560.10
* 68-4989	12-55-AL Rail Assy - G-narrow	\$2,108.17	* 68-5554	RAIL ASY W HK-53-56-8E	\$2,644.94
* 68-4990	12-55-AL Rail Assy - E-narrow	\$2,108.17	* 68-5559	RAIL ASY W HK-53-55-56-8F	\$2,644.94
68-5045	Screw pack MD8600 1/4	\$18.34	* 68-5560	RAIL ASY W HK-53-55-56-8J	\$2,644.94
68-5046	Screw pack MD8600 1/2	\$18.53	68-5562	RL/TCH Bar Assy W 16-56-8E	\$2,390.91
* 68-5048	TL-8E RAIL ASY	\$1,355.59	68-5563	RL/TCH Bar Assy W 16-56-8F	\$2,390.91
* 68-5049	TL-8F RAIL ASY	\$1,355.59	68-5564	RL/TCH Bar Assy W 16-56-8J	\$2,390.91
* 68-5050	TL-8G RAIL ASY	\$1,355.59	68-5565	RL/TCH Bar Assy W 16-56-8G	\$2,390.91
* 68-5051	TL-8J RAIL ASY	\$1,355.59	* 68-5566	16-55-56-8E Wide Rail Assy	\$2,622.05
68-5068	MD8600 Chassis assy. (LHR)	\$555.26	* 68-5567	16-55-56-8F Wide Rail Assy	\$2,622.05
68-5069	MD8600 CHASSIS ASY (RHR)	\$555.26	* 68-5568	16-55-56-8J Wide Rail Assy	\$2,622.05
68-5070	59-8600 CHASSIS ASY (LH)	\$565.17	* 68-5569	16-55-56-8G Wide Rail Assy	\$2,622.05
68-5071	59-8600 CHASSIS ASY (RH)	\$565.17	* 68-5575	16-53-55-56-8F Wide Rail Assy	\$2,834.76
* 68-5073	TL-55-8F RAIL ASY	\$2,108.76	* 68-5578	56- 8E Narrow Rail Assy	\$2,316.30

*Specify hardware or painted finish required. Consult catalog for available finishes.

Experience a safer
and more open world

Copyright © 2002-2021 Sargent Manufacturing Company, an ASSA ABLOY Group company. All rights reserved.
Reproduction in whole or in part without the express written permission of Sargent Manufacturing Company is prohibited.
Contact us at: 800-727-5477 or visit www.sargentlock.com. In Canada contact us at: 800-461-3007 or visit www.assaabloydss.ca

USA & Canada Prices Effective May 1, 2021

Part No.	Price	Part No.	Price
* 68-5579 55-56- 8E Narrow Rail Assy	\$2,394.40	* 68-7128 16-19-53-55-8F Narrow Rail Assy	\$1,735.53
* 68-5582 19-56- 8E Narrow Rail Assy	\$2,122.40	68-7306 FM8713 Chassis Assy LHR	\$588.60
* 68-5587 HK-56-8F Narrow Rail Assy	\$2,216.96	68-7307 FM8713 Chassis Assy RHR	\$588.60
* 68-5590 HK-55-56- 8E Narrow Rail Assy	\$2,560.10	68-7308 FM8700 Chassis Assy LHR	\$317.82
* 68-5591 HK-55-56- 8F Narrow Rail Assy	\$2,560.10	68-7309 FM8700 Chassis Assy RHR	\$317.82
* 68-5592 HK-55-56- 8J Narrow Rail Assy	\$2,560.10	68-7312 FM 8715 Chassis Assy LHR	\$569.88
* 68-5593 HK-55-56- 8G Narrow Rail Assy	\$2,560.10	68-7313 FM 8715 Chassis Assy RHR	\$569.88
* 68-5618 RL/TCH Bar Assy N 16-56-8E	\$2,385.39	68-7409 53-Chassis Assy	\$346.06
* 68-5619 RL/TCH Bar Assy N 16-56-8F	\$2,385.39	68-7410 12-53-Chassis Assy	\$392.20
* 68-5620 RL/TCH Bar Assy N 16-56-8J	\$2,385.39	68-7411 Chassis Assy (53-8500)	\$658.76
* 68-5621 RL/TCH Bar Assy N 16-56-8G	\$2,385.39	* 68-7412 53-8504,06,10,13,15,73,74 C/C	\$1,059.75
* 68-5622 16-55-56- 8E Narrow Rail Assy	\$2,535.74	68-7546 Motor Actuator Assy	\$110.81
* 68-5623 16-55-56- 8F Narrow Rail Assy	\$2,535.74	* 76-0027 Knob collar	\$13.27
* 68-5624 16-55-56- 8J Narrow Rail Assy	\$2,535.74	76-0563 Spiral pin	\$0.47
* 68-5625 16-55-56- 8G Narrow Rail Assy	\$2,535.74	77-0086 Inside knob shank	\$35.73
* 68-5634 16-19-56- 8E Narrow Rail Assy	\$2,316.30	77-0189 Rose bushing insert	\$1.73
* 68-5635 16-19-56- 8F Narrow Rail Assy	\$2,316.30	* 77-0550 Rose bushing	\$23.91
* 68-5636 16-19-56- 8J Narrow Rail Assy	\$2,316.30	* 77-0883 ASA Strike Crvd Lip 1-1/4"	\$37.50
* 68-5637 16-19-56- 8G Narrow Rail Assy	\$2,316.30	77-3915 Half spindle unit 8300 & 8900 1-3/4"-2-1/4" doors	\$32.25
* 68-5647 16-19-53-55-56- 8F Narrow Rail Assy	\$2,995.16	77-3916 Half spindle unit 8300 & 8900 2-1/4" - 3" doors	\$32.25
* 68-5648 16-19-53-55-56- 8J Narrow Rail Assy	\$2,995.16	77-3917 Half spindle unit 8300 & 8900 over 3" doors	\$48.39
* 68-5650 16-19-56- 8E Wide Rail Assy	\$2,316.30	94-0018 Inner chassis spring	\$17.65
* 68-5651 16-19-56- 8F Wide Rail Assy	\$2,316.30	94-0038 Bottom bolt	\$75.94
* 68-5652 16-19-56- 8J Wide Rail Assy	\$2,316.30	94-0039 Bolt sleeve	\$98.50
* 68-5653 16-19-56- 8G Wide Rail Assy	\$2,316.30	94-0051 Lever locking plate	\$4.50
68-5820 SCREW PACK FM8700	\$28.85	94-0054 Lever spring	\$23.67
68-5821 Screw pack 56 Kit	\$18.25	* 94-0056 Cylinder blocking ring (41 & 71 size)	\$12.60
68-5880 New Style 8500 Chassis asy	\$331.02	* 94-0058 Cylinder blocking ring (42 & 72 size)	\$16.12
68-5881 (GL-8500) Chassis asy	\$369.41	94-0106 Pin	\$1.72
68-5882 (59-8500) Chassis asy	\$645.07	94-0109 Spring	\$15.36
* 68-5989 59-8500 UNIV C-CASE PK	\$1,171.27	94-0110 Cam	\$10.33
* 68-5990 8500 (STD) UNIV C-CASE PK	\$713.36	94-0112 Locking lever (306)	\$25.40
68-5991 Mounting plate screw pack	\$14.02	94-0113 Locking lever	\$25.40
68-5992 GL-8500 UNIV C-CASE PK	\$758.99	94-0114 Locking lever (113, 313)	\$25.40
68-5944 8400 CHASSIS AY CLAD LHRB	\$535.89	* 94-0119 Cover	\$89.85
68-5945 8400 CHASSIS AY CLAD RHRB	\$535.89	94-0188 Lifting Lever	\$15.15
68-5946 8400 CHASSIS AY 1/2" CLAD LHRB	\$555.26	* 94-0189 Cylinder Operation Escutcheon	\$180.35
68-5951 8400 CHASSIS AY 1/2" CLAD RHRB	\$555.26	* 94-0190 Crossbar for 9400 only	\$375.20
68-6013 8400 CHASSIS AY 1/4" CLAD LHRB	\$554.46	* 94-2376 Center Case, Active RHRB	\$631.31
68-6014 8400 CHASSIS AY 1/4" CLAD RHRB	\$554.46	* 94-2377 Center Case, Active LHRB	\$631.31
68-6021 8500 Latch Bolt Assy	\$29.01	* 94-2378 Fire Rated Center Case, Active RHRB	\$1,262.60
68-6042 Chassis Assy HC4 8706/13 LHRB	\$1,417.23	* 94-2379 Fire Rated Center Case, Active LHRB	\$1,262.60
68-6043 Chassis Assy HC4 8706/13 RHRB	\$1,417.23	* 94-2380 9410 RHRB C/C Inactive	\$623.76
68-6044 Chassis Assy HC4 8715/73/74 LHRB	\$1,417.23	* 94-2381 9410 LHRB C/C Inactive	\$623.76
68-6045 Chassis Assy HC4 8715/73/74 RHRB	\$1,417.23	* 94-2384 Tenon Packet	\$68.54
68-6046 Chassis Assy HC4 8710 LHRB	\$1,417.23	94-2385 Top Latch Assembly	\$333.70
68-6047 Chassis Assy HC4 8710 RHRB	\$1,417.23	94-2386 Bottom Bolt Assembly (26D only)	\$360.77
* 68-7111 19-53-55-8E Wide Rail Assy	\$1,594.05	94-2387 Screw Pack (mounting screws)	\$24.72
* 68-7112 9-53-55-8F Wide Rail Assy	\$1,594.05	94-2390 Top Strike Pack	\$54.17
* 68-7113 19-53-55-8J Wide Rail Assy	\$1,594.05	94-2391 Bottom Strike Pack	\$39.68
* 68-7119 12-19-53-55-8E Wide Rail Assy	\$1,782.67	94-2008 Inner case assembly (8400 x control x no trim)	\$290.98
* 68-7120 12-19-53-55-8F Wide Rail Assy	\$1,782.67	94-2016 Bottom Case & Bolt Assy 8400	\$347.98
* 68-7121 12-19-53-55-8J Wide Rail Assy	\$1,782.67	94-2087 Lever assembly (106, 113)	\$42.14
* 68-7122 12-19-53-55-8G Wide Rail Assy	\$1,782.67	94-2088 Lever assembly (313)	\$42.14

*Specify hardware or painted finish required. Consult catalog for available finishes.

ED-68 EXIT DEVICES

SARGENT®

ASSA ABLOY

PARTS

USA & Canada Prices Effective May 1, 2021

Part No.	Price	Part No.	Price		
94-2089	Chassis assembly	\$309.30	97-0270	Top reinforcement	\$20.95
*94-2121	Turn lever assembly	\$132.07	*97-0285	Inside lever 306/313 control (8700)	\$271.73
94-2249	Locking lever & pin assy. (106)	\$39.35	*97-0286	Plate (828)	\$300.08
94-2329	Lever Assembly 206-306	\$39.35	*97-0291	Plate (842)	\$167.33
94-2441	Bottom rod and bolt kit for FM7100	\$529.19	97-0294	Pivot pin	\$4.27
94-2442	Bottom Bolt Strike Pack	\$72.88	97-0295	Top Chassis 9700	\$63.84
96-0061	Inner chassis bracket	\$34.42	97-0296	Latchbolt	\$66.49
97-0001	Dogging key	\$4.08	97-0298	Top slide	\$14.55
97-0006	Locking slide spring (specify hand)	\$25.22	97-0300	Spring	\$16.67
*97-0008	End plug for 90 series	\$15.87	*97-0302	Cylinder ring 7-pin	\$25.03
97-0012	Main arm spring	\$2.65	97-0305	Insert	\$1.42
*97-0015	12-90 Bracket Cover	\$200.68	*97-0309	Plate (874DT)	\$167.33
*97-0018	Cover Top & Bottom for 8700	\$137.81	*97-0311	Plate (894)	\$167.33
*97-0020	Guide	\$42.54	*97-0312	Plate (884)	\$167.33
97-0029	Bracket pivot pin	\$8.74	*97-0313	Plate (874)	\$167.33
97-0030	Pivot pin	\$8.74	97-0347	Locking slide spring	\$6.30
97-0031	Main arm spacer	\$2.65	*97-0349	16-Cylinder Collar 41 Cylinder	\$11.78
97-0032	Main slide	\$120.75	*97-0350	Collar 41 & 71 (706, 713) (Arrow, Best, Falcon 16-)	\$18.24
97-0035	Retractor	\$12.60	*97-0351	Collar 42 & 72 (706, 713)	\$18.24
97-0036	Sliding bolt	\$62.82	*97-0352	Collar 43 (706, 715)	\$18.24
97-0037	Knob slide	\$62.82	97-0356	Locking Slide	\$50.81
97-0039	Bottom sliding bolt	\$72.38	97-0360	Spring Link	\$2.49
97-0040	Bushing	\$6.70	97-0362	Hub Spring	\$1.46
97-0042	Knob hub	\$50.02	*97-0367	Grip	\$292.35
97-0043	Knob hub retainer	\$8.74	*97-0392	Top cover After (1/92) for 12-8700	\$137.82
97-0045	Bushing pin	\$2.65	97-0425	Spring	\$11.20
97-0046	Retaining pin	\$2.65	97-0454	Bottom Bolt Spring	\$2.84
97-0048	Rod adj. pin	\$1.42	97-0475	FW743 Locking Slide	\$60.39
97-0049	Rod adj. pin (13-9700)	\$1.42	97-0477	FW-ET Bushing Insert	\$8.98
97-0050	Spring	\$2.24	97-0508	Lower Hub Plate FW700(-5,-8)	\$4.93
97-0051	Spring	\$2.24	97-0527	RETAINING RING	\$1.21
*97-0052	Screw	\$0.71	97-0551	2-1/4" lockable spindle	\$33.54
97-0053	Latchbolt	\$66.49	*97-0562	2 Plate (PSB)	\$177.03
*97-0058	Grip	\$300.08	97-0566	"J" lever spring	\$11.20
*97-0060	Grommet nut	\$8.74	97-0568	Wrench – Cyl. Nut	\$16.78
*97-0064	Grip	\$300.08	97-0573	Spindle (04 & 10 function)	\$7.48
97-0075	Lift lever	\$10.38	97-0577	Main slide - 9700	\$101.95
97-0076	Sliding bolt	\$116.93	97-0579	Spring (Torsion)	\$1.91
97-0079	Filler cap	\$100.46	97-2001	Locking slide Assy. 9700	\$25.03
*97-0084	Cover 12-8700 top case (old/before 1/92)	\$143.51	97-2002	12-Bot. case Assy. less cover (Old Style)	\$500.12
*97-0086	Cover 12-9700 (center cover)	\$251.10	97-2003	12-Top case Assy. less cover (Old Style)	\$598.93
*97-0087	Cover (12-bottom cover)	\$143.51	97-2038	Bot. case Assy. less cover (Before 11/11/02)	\$357.38
97-0089	Thumb piece lever	\$74.41	97-2039	14-Bottom case Assy. less cover (Before 11/11/02)	\$155.17
97-0090	Thumb piece slide	\$74.41	*97-2040	9710 Ctr Case Asy	\$675.28
97-0101	Retractor spring	\$8.74	*97-2042	9706/13 Ctr Case Asy	\$766.53
*97-0114	Plate (818)	\$300.08	97-2046	Top slide/roll pin Assy.	\$145.97
97-0119	Thru bolt stud	\$12.60	97-2048	Cylinder hub Assy.	\$33.34
*97-0122	Plate (838)	\$300.08	*97-2237	Ctr Sub Case - 12-9710	\$857.77
97-0131	Thumb piece backup plate	\$10.38	*97-2240	Ctr Sub Case - 12-9706 & 13	\$949.03
97-0156	Oval head rivet	\$0.71	*97-2302	Ctr Sub Case - 12-9762 & 63	\$1,003.78
*97-0182	Thumb piece (LHR)	\$124.85	*97-2369	9710 C.C. Pack	\$912.53
*97-0189	Thumb piece (RHR)	\$124.85	*97-2371	9706/13 C.C. Pack	\$1,003.78
*97-0203	Thumb piece (LH)	\$133.78	*97-2378	Inside lever Assy. (9700)	\$271.73
*97-0214	Thumb piece (RH)	\$133.78	*97-2381	9715 Center case assy	\$681.68

*Specify hardware or painted finish required. Consult catalog for available finishes.

Experience a safer
and more open world

Copyright © 2002-2021 Sargent Manufacturing Company, an ASSA ABLOY Group company. All rights reserved.
Reproduction in whole or in part without the express written permission of Sargent Manufacturing Company is prohibited.
Contact us at: 800-727-5477 or visit www.sargentlock.com. In Canada contact us at: 800-461-3007 or visit www.assaabloydss.ca

USA & Canada Prices Effective May 1, 2021

Part No.	Price	Part No.	Price		
*97-2384	9728 Center case assy	\$730.03	*98-2161	9898 CTR Case Pk.	\$799.46
*97-2402	9715 Center case pack	\$912.53	*98-2162	Bracket Pack (includes cover)	\$433.00
*97-2404	9728 Center case pack	\$967.24	*98-2163	9898 Ctr Case Assy. (less cover)	\$558.45
*97-2406	Ctr Sub Case - 12-9715	\$857.77	*98-2469	12-9804 LHRB Chassis asy	\$1,362.12
*97-2407	Ctr Sub Case - 12-9728	\$912.53	*98-2470	12-9804 RHRB Chassis asy	\$1,362.12
97-2434	Top case Assy. less cover (Before 11/11/02)	\$426.32	*98-2479	12-9863 LHRB Chassis Assy	\$1,341.46
97-2854	Chassis Assy - (12-)9715	\$502.34	*98-2480	12-9863 RHRB Chassis Assy	\$1,341.46
*97-2868	Top & Bottom Case Pack (Before 11/11/02)	\$1,051.04	*98-2492	Center Case Pk LHRB	\$1,171.42
*97-2952	Screw Pak 800 Series	\$15.64	*98-2493	Center Case Pk RHRB	\$1,171.42
*97-2953	Screw Pak 800 Series	\$11.15	*98-2496	Center Case Pk LHRB (12-9863)	\$1,293.18
97-2963	12-Top case Assy. (Before 11/11/02)	\$479.39	*98-2497	Center Case Pk RHRB (12-9863)	\$1,293.18
*97-2972	Ctr Case Pk - 12-9710	\$1,095.02	*98-2503	Chassis Assy. 9804	\$579.60
*97-2973	Ctr Case PK - 12-9715	\$1,095.02	*98-2504	Chassis Assy 9810	\$579.60
*97-2974	Ctr Case Pk - 12-9728	\$1,149.78	*98-2505	Chassis Assy 9813	\$988.81
*97-2975	Ctr Case Pk - 12-9706 & 13	\$1,186.27	*98-2506	Chassis Assy 9815	\$988.81
*97-2976	Ctr Case Pk - 12-9762 & 63	\$1,241.02	*98-2507	CHASSIS ASY 9828	\$579.60
97-3066	Switch & Cable Assy.	\$89.43	*98-2510	CTR CASE PK 9804	\$1,129.00
97-3092	FW SPIN ASY 1 3/4 (700&8)	\$14.67	*98-2511	CTR CASE PK 9810	\$1,151.98
97-3098	FW Spindle Asy 1-3/4"	\$49.18	*98-2512	CTR CASE PK 9813	\$1,088.56
97-3137	Switch/Mtg. Plate Assy.	\$248.23	*98-2513	CTR CASE PK 9815	\$1,209.62
97-3230	16- Cylinder Dogging Assy	\$42.02	*98-2515	CTR CASE PK 9863	\$1,104.77
98-0009	Latchbolt lever LHRB	\$20.95	*98-2517	CHASSIS ASY 9800 (75,76)	\$1,021.55
98-0010	Latchbolt lever RHRB	\$20.95	98-2518	L980 & L980A Assembly	\$447.28
98-0011	Lever pivot pin	\$6.30	98-2520	12-L980 Latch Assy (Retrofits L980S)	\$447.28
98-0018	Outside cylinder hub	\$24.22	98-2597	12-HCL980 Latch Assy (Retrofits HC-L980)	\$467.59
98-0020	Cylinder support	\$32.44	*99-0007	Cylinder ring 16 & 66	\$51.60
*98-0021	Cylinder blocking ring	\$25.03	99-0009	Mortise lock lever RHRB	\$51.60
98-0027	Spring	\$2.24	99-0010	Mortise lock lever LHRB	\$51.60
98-0028	Latchbolt spring	\$2.65	99-0011	Pivot pin	\$4.37
98-0036	Shim for 646/649	\$27.65	*99-0012	12-9900 Cover	\$255.98
*98-0049	Plate (818)	\$159.37	99-0057	Guardbolt spring	\$2.29
98-0071	Thru bolt stud	\$20.17	99-0058	Slide guide	\$4.37
98-0111	Main arm spring	\$2.24	99-0060	Guardbolt lever	\$4.37
*98-0112	Arm 97, 98, 99, 9898 Exit Device	\$114.15	99-0061	Thumb piece lever spring	\$2.29
98-0115	Compression Spring	\$2.24	99-0063	Guardbolt lever spring	\$2.29
*98-0117	Bracket cover 9700 & 9898	\$200.68	99-0072	Guardbolt eyelet	\$2.07
*98-0118	Plate PTB-98K	\$159.37	99-0075	Anti-Friction bolt	\$42.64
*98-0119	Plate PTB-98T	\$159.37	99-0076	Slide space	\$4.37
98-0123	Latchbolt	\$77.46	99-0077	Guardbolt tail piece	\$2.29
98-0124	Thumb piece lever	\$27.27	99-0078	Cylinder set screw	\$2.29
*98-0125	Plate (98E)	\$159.37	99-0088	Thumb piece lever	\$27.78
*98-0126	Plate (98D)	\$159.37	99-0098	Anti-Friction bolt pivot pin	\$4.37
98-0155	Main arm spring	\$2.84	99-0206	Knob hub	\$51.60
*98-0209	Cover 9898	\$139.45	99-0208	Locking lever	\$12.85
*98-0233	Cover (12-9800) LHRB	\$139.45	99-0212	Pin	\$1.46
*98-0234	Cover (12-9800) RHRB	\$139.45	*99-0216	Front RHRB 963, 928	\$162.50
98-0248	Guide Pin	\$15.80	*99-0217	Front LHRB 963, 928	\$162.50
98-0276	Collar-12-L980	\$16.39	*99-0218	Front LHR flat 963, 928	\$162.50
98-0277	Collar-EL980	\$16.39	*99-0219	Front RHR flat 963, 928	\$162.50
*98-2011	Bracket Pack 12- (includes cover)	\$453.94	99-0223	Slide guide	\$8.28
98-2034	L.B. & Pin Assy LHRB 20, 60, 90	\$55.91	99-0224	Thumb Piece Lever	\$39.98
98-2035	L.B. & Pin Assy RHRB 20, 60, 90	\$55.91	*99-0226	Front LHRB for 916, 966	\$162.50
*98-2156	Arm 9800	\$136.02	*99-0227	Front RHRB for 916, 966	\$162.50
98-2159	Bolt spring & bracket Assy.	\$32.13	*99-0228	Front LHR flat for 916, 966	\$162.50

*Specify hardware or painted finish required. Consult catalog for available finishes.

ED-70 EXIT DEVICES

SARGENT®

ASSA ABLOY

PARTS

USA & Canada Prices Effective May 1, 2021

Part No.		Price
*99-0229	Front RHR flat for 916, 966	\$162.50
99-0236	Cylinder clamp	\$8.72
99-0249	Roll pin for 916, 966	\$1.08
99-0279	Guardbolt Assy. LHRB	\$93.48
99-0280	Guardbolt Assy. RHRB	\$93.48
99-2035	Guardbolt Assy. LHRB	\$32.76
99-2036	Guardbolt Assy. RHRB	\$32.76
99-2050	Slide, bushing Assy.	\$67.75
99-2052	Guardbolt Assy.	\$34.18
99-2059	Lever slide Assy.	\$17.01
99-2247	Latchbolt Assy.	\$170.53
99-2389	Latchbolt lever Assy.	\$67.75
*99-2511	CTR CSE SUB-ASSY LHRB	\$786.64
*99-2512	CTR CSE SUB-ASSY RHRB	\$786.64
*99-2520	9900 CC PK LHRB	\$1,439.01
*99-2521	9900 CC PK RHRB	\$1,439.01
*99-2525	12-9900 CC PK LHRB	\$1,439.01
*99-2526	12-9900 CC PK RHRB	\$1,439.01

*Specify hardware or painted finish required. Consult catalog for available finishes.

Experience a safer
and more open world

Copyright © 2002-2021 Sargent Manufacturing Company, an ASSA ABLOY Group company. All rights reserved.
Reproduction in whole or in part without the express written permission of Sargent Manufacturing Company is prohibited.
Contact us at: 800-727-5477 or visit www.sargentlock.com. In Canada contact us at: 800-461-3007 or visit www.assaabloydss.ca

AUXILIARY LOCKS

470-SSL1 Series Auxiliary Lock.....	AL-1
480 Series Deadbolt.....	AL-2
4870 Series Mortise Deadlock.....	AL-3
460-480-4870 Strikes & Parts.....	AL-4
4870 Parts.....	AL-5

Locker & Utility Locks

Locker & Utility Locks.....	AL-6
Padlock-758.....	AL-7
Padlock-858.....	AL-8

470/SSL1 AUXILIARY LOCKS

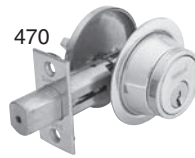

USA & Canada Prices Effective May 1, 2021

470 Series		
Options	Description	Price
1	1-3/8" to 1-3/4" thick door adapter	No addition
10	SARGENT Signature System	Add \$63.00 /cyl.
11	SARGENT XC Key System (not available with 10, 22, SC, SE options)	No addition
13	Front and strike with 1/4" radius corners	No addition
15	Drive-in adjustable backset bolt x 26D only	No addition
*21	SARGENT Construction Key System (lost ball)	Add \$16.00 /cyl.
28	408 Flat lip strike 4-7/8" x 1-1/4" ANSI A115.2	No addition
BR	SARGENT Bump Resistant Cyls. (N/A w/10, 22, 30, 60, 63, 64, 70, 72, 73, 737P, KESO, SC, & SE options)	Add \$25.00 /cyl.
LC	Less Cylinder	No Deduct
SC	Schlage "C" keyway cylindrical (0-Bitted)	No Addition
SE	Schlage "E" keyway cylindrical (0-Bitted)	No addition

* Refer to CK-3 for additional masterkeying charges when using this option.

470 Series Bored Deadbolt		Finish	
Number	Description	10BE/26D/BSP/WSP	03/04/10/10B/26
474	Double Cylinder	\$156.00	\$163.00
475	Single Cylinder by thumbturn inside	\$121.00	\$128.00
479	No cylinder, thumbturn inside	\$88.00	\$92.00

470 Parts	Description	03/04/10/10B/10BE/26/26D/BSP/WSP
16-0321	Plastic filler to allow standard bolt to fit a standard 161 door prep (No finish needed)	\$2.19
16-0322	Spacer Ring (for 1- option)	\$13.06
16-0331	Spacer Ring (1-3/8" Door – 1- option)	\$13.06
16-2495	Standard adjustable backset bolt (2-3/8" or 2-3/4" backsets)	\$47.92
16-2496	1/4" radius corner adjustable backset bolt (2-3/8" or 2-3/4" backsets)	\$47.92
16-2497	Adjustable backset drive-in bolt (2-3/8" or 2 3/4" backsets)	\$47.92

470 Strikes	Description	10BE/26D/BSP/WSP	03/04/10/10B/26
406	Standard Strike		
407	1/4" Radius Strike	\$14.16	\$15.66
408	Flat Lip Strike 4-7/8"x 1-1/4" - (28-)	\$23.36	\$33.16

Note: Split finishes are not available for 470's.

SSL1 Options	Description	Price
SG	MicroShield® an antimicrobial powder coat	\$42.00

Cat#	Description	03/04/10/10B/10BE/26/26D/BSP/WSP
SSL1	SSL1 Auxiliary Latch	\$165.00

AL-2 AUXILIARY LOCKS

SARGENT®

480 DEADBOLTS

ASSA ABLOY

USA & Canada Prices Effective May 1, 2021

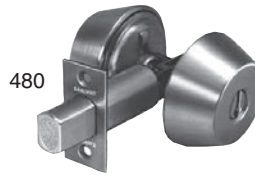

480 Series		
Options	Description	Price
10	SARGENT Signature System	Add \$63.00 /cyl
11	SARGENT XC Key System (not available with 10, 22, SC, SE options)	No addition
1160	Sargent XC Large Format Interchangeable Plastic Disposable Construction Core	No addition
1163	Sargent XC Large Format Interchangeable Core Cylinder - Includes masterkeying charges	\$83.00
1164	Sargent XC Large Format Interchangeable Construction Core Cylinder	\$83.00
1170	Small Format interchangeable disposable construction core - to accept 7 Pin XC permanent core	No Add
11727P	Small Format interchangeable keyed construction core - to accept 7 Pin XC permanent core	\$75.00
11737P	Small Format interchangeable core - to accept 7 pin XC permanent core	\$75.00
16	400 "T" Shaped Strike 2-3/4" x 1-1/8"	Add \$2.00
20	2-3/8" Backset — 2-3/4" x 1" front	No addition
21	SARGENT Construction Key System (lost ball) Standard on all new systems est. 5/1/96	Add \$16.00 /cyl
22	SARGENT Construction Key System (split key) To be used on pre-est. split key systems only	Add \$32.00 /cyl
28	408 Flat Lip Strike 4-7/8" X 1-1/4" ANSI A115.2	No addition
36	6-Lobe security Head Screw	Add \$24.00
37	Spanner Head Screw	Add \$17.00
48	488 Strike 3-5/8" x 1-1/4"	Add \$2.00
60	SARGENT Large Format Interchangeable Plastic Disposable Construction Core	No addition
63	SARGENT Large Format Interchangeable Core Cylinder includes master and grandmaster keying charge	Add \$83.00 /cyl
64	SARGENT Large Format Interchangeable Construction Core Cylinder	\$83.00
6573	Small Format 6-Pin Uncombined Core (Refer to CK-12)	Add \$65.00 /cyl
65737P	Small Format 7-Pin Uncombined Core (Refer to CK-12)	Add \$65.00 /cyl
70	Small Format Interchangeable disposable plastic construction core	No Add
72	Small Format Interchangeable 6 pin construction core (7-pin with 11 option)	\$75.00
73	Small Format interchangeable core 6-pin Includes MK and GMK keying charges	Add \$75.00 /cyl
737P	Small Format interchangeable core 7-pin (refer to CK-12 for available keyways) Includes MK and GMK keying charges	Add \$75.00 /cyl
BR	SARGENT Bump Resistant Cyls. (N/A w/10, 22, 30, 60, 63, 64, 70, 72, 73, 737P, KESO, SC, SE)	Add \$25.00 /cyl
DG1	Patented Degree DG1 Key System	No addition
DG160	Hardware prepared for DG1-6300 Lg. Format IC cores, supplied with temporary plastic construction cores	No addition
DG163	Patented Degree DG1 Large Format Interchangeable Core Cylinder - Includes master keying charges	\$83.00
DG164	Hardware prepared for DG1-6300 Lg. Format IC cores, supplied with temporary keyed construction cores	\$83.00
DG2	Patented Degree DG2 Key System incorporating a locking sidebar	\$63.00/cyl.
DG260	Hardware prepared for DG2-6300 Lg. Format IC cores, supplied with temporary plastic construction cores	No addition
DG263	Patented Degree DG2 Large Format Interchangeable Core Cylinder - Includes master keying charges	\$146.00
DG264	Hardware prepared for DG2-6300 Lg. Format IC cores, supplied with temporary keyed construction cores	\$83.00
DG3	Patented Degree DG3 Key System incorporating a locking sidebar and UL437 listed	\$89.00/cyl.
DG360	Hardware prepared for DG3-6300 Lg. Format IC cores, supplied with temporary plastic construction cores	No addition
DG363	Patented Degree DG3 Large Format Interchangeable Core Cylinder - Includes master keying charges	\$172.00
DG364	Hardware prepared for DG3-6300 Lg. Format IC cores, supplied with temporary keyed construction cores	\$83.00
LC	Less Cylinder	-\$94.00/cyl.
SC	Schlage "C" Keyway cylinder 0-Bitted	No Addition
SE	Schlage "E" Keyway cylinder 0-Bitted	No addition

480 Series Bored Deadlock		Finish	
Number	Description	10BE/26D/BSP/WSP	03/04/09 10/10B/14/15/26
484	Double Cylinder	\$310.00	\$317.00
485	Single Cylinder		
486	Single Cylinder	\$220.00	\$228.00
487	Classroom		
489	Exit	\$188.00	\$192.00

Note: Split finishes are available for 480's. Order outside/inside, price as higher price finish.

Experience a safer
and more open world

Copyright © 2002-2021 Sargent Manufacturing Company, an ASSA ABLOY Group company. All rights reserved.
Reproduction in whole or in part without the express written permission of Sargent Manufacturing Company is prohibited.
Contact us at: 800-727-5477 or visit www.sargentlock.com. In Canada contact us at: 800-461-3007 or visit www.assaabloydss.ca

4870 Series		
Options	Description	Price
10	SARGENT Signature System	Add \$63.00 /cyl
11	SARGENT XC Key System (not available with 10, 22, SC, SE options)	No addition
1160	Sargent XC Large Format Interchangeable Plastic Disposable Construction Core	No addition
1163	Sargent XC Large Format Interchangeable Core Cylinder - Includes masterkeying charges	\$83.00
1164	Sargent XC Large Format Interchangeable Construction Core Cylinder	\$83.00
1170	Small Format interchangeable disposable construction core - to accept 7 Pin XC permanent core	No Add
11727P	Small Format interchangeable keyed construction core - to accept 7 Pin XC permanent core	\$75.00
11737P	Small Format interchangeable core - to accept 7 pin XC permanent core	\$75.00
21	SARGENT Construction Key System (lost ball) Standard on all new systems est. 5/1/96	Add \$16.00 /cyl
22	SARGENT Construction Key System (split key) For pre-established split key systems only	Add \$32.00 /cyl
28	#7710 Strike 4-7/8" x 1-1/4"	No addition
36	6-Lobe security Head Screw	Add \$24.00
37	Spanner Head Screw	Add \$17.00
60	SARGENT Large Format Interchangeable Plastic Disposable Construction Core	No addition
63	SARGENT Large Format IC Core Cylinder includes master and grandmaster keying charge	Add \$83.00 /cyl
64	SARGENT Large Format Interchangeable Construction Core Cylinder	\$83.00
6573	Small Format 6-Pin Uncombined Core (Refer to CK-12)	Add \$65.00 /cyl
65737P	Small Format 7-Pin Uncombined Core (Refer to CK-12)	Add \$65.00 /cyl
70	Small Format Interchangeable disposable plastic construction core	No Add
72	Small Format Interchangeable 6 pin construction core (7-pin with 11 option)	\$75.00
73	Small Format Interchangeable 6-pin core (Includes MK and GMK keying charges) (refer to CK-8 for available keyways)	Add \$75.00 /cyl
737P	Small Format Interchangeable 7-pin core (Includes MK and GMK keying charges) (refer to CK-8 for available keyways)	Add \$75.00 /cyl
74	Lock Case Wrapped in Lead	Add \$294.00
81	Cylinders to accept KESO & KESO Removable Core – No core provided	No Add
F182	SARGENT KESO Security Cylinder – Patent Pending	Add \$91.00 /cyl.
F183	SARGENT KESO Security Removable Core Cylinder – Patent Pending	Add \$130.00 /cyl.
82	SARGENT KESO Security Cylinder (for existing systems only)	Add \$91.00 /cyl
83	SARGENT KESO Security Removable Core Cylinder (for existing systems only)	Add \$130.00 /cyl
84	SARGENT KESO Security Removable Construction Core Cylinder (for existing systems only)	See CK-18
BR	SARGENT Bump Resistant Cyls. (N/A w/10, 22, 30, 60, 63, 64, 70, 72, 73, 737P, KESO, SC, & SE options)	Add \$25.00 /cyl.
DG1	Patented Degree DG1 Key System	No addition
DG160	Hardware prepared for DG1-6300 Lg. Format IC cores, supplied with temporary plastic construction cores	No addition
DG163	Patented Degree DG1 Large Format Interchangeable Core Cylinder - Includes master keying charges	\$83.00
DG164	Hardware prepared for DG1-6300 Lg. Format IC cores, supplied with temporary keyed construction cores	\$83.00
DG2	Patented Degree DG2 Key System incorporating a locking sidebar	\$63.00/cyl.
DG260	Hardware prepared for DG2-6300 Lg. Format IC cores, supplied with temporary plastic construction cores	No addition
DG263	Patented Degree DG2 Large Format Interchangeable Core Cylinder - Includes master keying charges	\$146.00
DG264	Hardware prepared for DG2-6300 Lg. Format IC cores, supplied with temporary keyed construction cores	\$83.00
DG3	Patented Degree DG3 Key System incorporating a locking sidebar and UL437 listed	\$89.00/cyl.
DG360	Hardware prepared for DG3-6300 Lg. Format IC cores, supplied with temporary plastic construction cores	No addition
DG363	Patented Degree DG3 Large Format Interchangeable Core Cylinder - Includes master keying charges	\$172.00
DG364	Hardware prepared for DG3-6300 Lg. Format IC cores, supplied with temporary keyed construction cores	\$83.00
LB	Extra large thumbturn	\$18.00
LC	Less Cylinder	-\$96.00/cyl.
SC	Schlage "C" Keyway cylinder, (#41 mortise cylinder only – 0-bitted)	No Addition
SE	Schlage "E" Keyway cylinder, (#41 mortise cylinder only – 0-bitted)	No addition
SG	MicroShield® – an antimicrobial powder coat finish	Add \$42.00
WBS	Wrought Box Strike	No addition

Note: All 4870 cylinders are shipped with #97 Rosette standard.
Split finishes are available. Order outside/inside, price as higher price finish.



4870

4870 Mortise Deadlock		Finish	
Number	Description	10BE/26D/BSP/WSP	03/04/09/10/10B/10BL/15/20D/26/32/2D
4874	Double Cylinder	\$421.00	\$426.00
4875	Single Cylinder x Turn Lever	\$383.00	\$388.00
4876	Single Cylinder	\$322.00	\$327.00
4877	Classroom x Turn Lever	\$383.00	\$388.00
4878	Public Toilet (Double Cylinder)	\$481.00	\$486.00
4879	Exit	\$285.00	\$290.00
CPC	Clear Powder Coat over 26D/32D – How to order: 4875 x 32D x CPC All orders will continue to be handled as a "special" when CPC is required		Add \$39.00

AL-4 AUXILIARY LOCKS

SARGENT®

STRIKES & PARTS

ASSA ABLOY

USA & Canada Prices Effective May 1, 2021

480/4870 Auxiliary Lock Strikes		Finish	
Catalog #	Description	10BE/26D/32D/BSP/WSP	03/04/09/10/10B/10BL/26/32
400	"T" Shaped Strike 2-3/4" x 1-1/8" - 480 Series (28-)	\$14.16 (32D only)	\$15.66 (03, 09, 10, 10B only)
404	Standard Strike - 480 Series	\$14.16 (32D only)	\$15.66 (03, 09, 10, 10B only)
408	Flat Lip Strike 4-7/8"x 1-1/4" - 480 Series (28-)	\$23.36 (32D only)	\$33.16 (03, 09, 10, 10B only)
480	Standard Strike - 4870 Series	\$14.16	\$15.66
488	3-5/8" x 1-1/4" - 480 Series (48-)	\$31.66 (26D only)	\$37.67 (03, 09, 10, 10B only)
7710	Flat Lip Strike 4-7/8" x 1-1/4" - 4870 Series	\$23.36	\$33.16
7730	Optional Strike 4-7/8" x 1-1/4" - 4870 Series	\$23.36	\$33.16

480 Deadbolt Assembly		Finish	
Number	Description	10BE/26D/32D/BSP/WSP	03/04/10/10B/10BE/32D/BSP/WSP
*16-2149	2-3/4" Backset		\$73.89
*16-2153	2-3/8" Backset		\$73.89

Inside		10BE/26D/BSP/WSP	03/04/10/10B/26
*16-2177	For 484 Function (Cylinder Housing—Specify if 70's options))	\$49.90	\$49.90
*16-2039	For 485 & 489 Function (Turn)	\$43.52	\$43.52
*16-2179	For 487 Function (Turn)	\$30.34	\$30.34
16-0301	Mounting Plate 484, 485, 486, 487, 489 (inside and outside)	\$6.42	\$6.42
16-0302	Support Plate 485, 486, 487 & 489	\$6.42	\$6.42
*16-0306	For 486 Function (Blank Plate)	\$26.14	\$26.14
16-2511	Inside Cylinder Housing (484 with 60, 63, 64 option only)	\$42.45	\$42.45
*16-0326	Collar (480 inside & outside – 60, 63, 64 option only)	\$82.48	\$82.48
*16-0329	Face Plate	\$65.12	\$65.12

Outside		03/04/10/10B/10BE/26/26D/BSP/WSP
16-0301	Mounting Plate 484, 485, 486, 487	\$6.42
*16-2264	Outside Cylinder Housing & Tailpiece Assy. (484)	\$71.04
*16-2265	Outside Cylinder Housing & Tailpiece Assy. (485, 486, 487)	\$71.04
*16-0326	Cylinder Housing Collar	\$82.48
*16-2193	Screw Pack (48-484)	\$7.04
*16-2175	Cylinder Housing Only for 484, 485, 486 & 487	\$49.90
*16-2460	Blank Rose—489 Function (after 10/98)	\$43.52
*16-2510	Cylinder Housing Assy. (484 with 60-, 63-, 64- option only)	\$54.33
*16-2512	Cylinder Housing Assy. (485, 487 with 60-, 63-, 64- option only)	\$54.33
*16-2513	Cylinder Housing Assy. (486 with 60-, 63-, 64- option only)	\$54.33

480 Screw Packs		32D
*16-2201	Double Cylinder Function 484	
*16-2202	Single Cylinder Function 485, 486, 487	\$8.59
*16-2203	489 Function (with cam bar after 10/98)	

Parts	Description	Price
01-4446	Cylinder Clamp Screw & Washer	\$0.55
13-0880	Tailpiece 1-3/8" – 1-3/4" Door (485/487)	\$2.15
13-0878	Tailpiece 1-3/4" Door (484)	\$2.15
16-2508	Cam assy.-cyl. prong for 60-, 63-, 64- options	\$4.04
16-0277	Strike Box	\$4.41

*Specify Finish. Consult catalog for available finishes.

4870 MORTISE DEADBOLT PARTS

USA & Canada Prices Effective May 1, 2021

Parts		
Catalog #	Description	Price
* 97	Cylinder Collar includes ring	\$8.55
* 130W	Turn Lever Pack	ML-117
01-0074	Retaining Ring (hub)	\$1.07
01-0098	Retaining Ring	\$1.07
01-0543	Springrip Fastener	\$1.81
* 01-1028	Outside Front Screw	\$0.85
01-1142	Case Screw	\$0.80
* 01-2034	#6 x 3/8" PH HD Wood Screw	\$0.95
* 01-2035	#6 x 1/2" PH HD Wood Screw	\$0.95
* 01-3151	#6-32 x 5/16" PH HD M.S.	\$1.33
* 01-5000	Inside Front Screw	\$0.89
* 48-0042	Outside Front	\$40.29
* 48-2056	Screw Pack for 4800	\$13.36
* 77-0137	Plate	\$32.17
77-0772	Spindle	\$8.41
77-0826	Spindle	\$19.80
* 77-2167	Turn Lever Assembly.	\$32.56

*Specify hardware finish. Consult catalog for available finishes

AL-6 AUXILIARY LOCKS

SARGENT®

LOCKER & UTILITY LOCKS

ASSA ABLOY

USA & Canada Prices Effective May 1, 2021

Option	Description	Price
21	SARGENT Construction Key System (Lost ball) (Refer to CK-3 for additional masterkeying charges when using this option)	Add \$16.00

Utility and Cabinet Locks		Finish		
Number		10BE/26D/BSP/WSP	03/04/10/26	10B/32/32D
4142, 4143		\$124.00	\$128.00	\$135.00
13-0178	Barrel (Plug)- US4 or 15	\$32.84		
13-0179	Cam-nonhanded	\$32.75		

Prefix	Description	Price
10	SARGENT Signature System	\$63.00
11	SARGENT XC Key System	No addition
21	SARGENT Construction Key System (lost ball) Standard on new systems est. since 5/1/96	\$16.00
22	Construction Key System (split key) To be used on pre-established split key systems only	\$32.00

(Refer to CK-3 for additional masterkeying charges when using this prefix)

Locker Locks		Finish
Number		04/26D
1655		\$157.00

Parts	Description	Price
C1655-1	Cylinder & tailpiece assy	\$95.00
13-1813	Tailpiece	\$7.17

758 Padlock		
Options	Description	Price
10	SARGENT Signature System	Add \$63.00 /cyl
* 11	SARGENT XC Key System (not available with 10, 22, SC, SE options)	No addition
1160	Sargent XC Large Format Interchangeable Plastic Disposable Construction Core	No addition
1163	Sargent XC Large Format Interchangeable Core Cylinder - Includes masterkeying charges	\$83.00
1164	Sargent XC Large Format Interchangeable Construction Core Cylinder	\$83.00
* 21	SARGENT Construction Key System (lost ball) Standard on all new systems est. since 5/1/96	Add \$16.00 /cyl
* 22	SARGENT Construction Key System (split key) To be used on pre-est. split key systems only	Add \$32.00 /cyl
* 51	SARGENT Old Style Removable Core	Add \$85.00 /cyl
* 52	SARGENT Old Style Construction Removable Core	\$83.00
60	SARGENT Large Format Interchangeable Plastic Disposable Construction Core	No addition
63	SARGENT Large Format IC Core Cylinder includes master and grandmaster keying charge	Add \$83.00 /cyl
64	SARGENT Large Format Interchangeable Construction Core Cylinder	\$83.00
BR	SARGENT Bump Resistant Cyls. (N/A w/10, 22, 30, 60, 63, 64, 70, 72, 73, 737P, KESO, SC, & SE prefixes)	\$25.00
DG1	Patented Degree DG1 Key System	No addition
DG160	Hardware prepared for DG1-6300 Lg. Format IC cores, supplied with temporary plastic construction cores	No addition
DG163	Patented Degree DG1 Large Format Interchangeable Core Cylinder - Includes master keying charges	\$83.00
DG164	Hardware prepared for DG1-6300 Lg. Format IC cores, supplied with temporary keyed construction cores	\$83.00
DG2	Patented Degree DG2 Key System incorporating a locking sidebar	\$63.00/cyl.
DG260	Hardware prepared for DG2-6300 Lg. Format IC cores, supplied with temporary plastic construction cores	No addition
DG263	Patented Degree DG2 Large Format Interchangeable Core Cylinder - Includes master keying charges	\$146.00
DG264	Hardware prepared for DG2-6300 Lg. Format IC cores, supplied with temporary keyed construction cores	\$83.00
DG3	Patented Degree DG3 Key System incorporating a locking sidebar and UL437 listed	\$89.00/cyl.
DG360	Hardware prepared for DG3-6300 Lg. Format IC cores, supplied with temporary plastic construction cores	No addition
DG363	Patented Degree DG3 Large Format Interchangeable Core Cylinder - Includes master keying charges	\$172.00
DG364	Hardware prepared for DG3-6300 Lg. Format IC cores, supplied with temporary keyed construction cores	\$83.00
LC	Less Cylinder	-\$21.00/cyl.
SC	Schlage "C" Keyway Cylinder - O Bitted	No Addition
SE	Schlage "E" Keyway Cylinder - O Bitted	No addition

* Refer to CK-3 for additional master keying charges when using this option

Padlock		
Number		Price
758	Key Retaining Padlock	\$137.00
Shackle Types and Suffixes		
Heights: 1"-Standard, 2" (-2 suffix), & 4" (-4 suffix)		N/C
Material: Stainless Steel-Standard , Hardened Steel-Optional specify (-HS suffix)		N/C
Chain specify -C suffix		\$2.00

Removable Core Only For No. 63-758 Padlock		
Number		Price
6300	SARGENT Removable Core	\$83.00
65-6300	SARGENT Removable Core Unassembled	\$73.00

KESO Padlocks		
KESO F1 (Patented) Padlocks		See page CK-21
KESO Padlocks		See page CK-26

Parts	Description	Price
13-1230	Standard Cylinder Tailpiece	\$2.07
13-1231	Tailpiece for use with 63 or 60 option + Padlock	\$4.27
C750-1	758/858 Cylinder & Tailpiece Assembly	\$95.00
10 C750-1	758/858 Cylinder & Tailpiece Assembly (10 option)	\$158.00
17-2006	Chain & Clevis Assembly	\$28.19
17-2633	758/858 Cylinder Retainer & Screw Pack	\$15.65

AL-8 AUXILIARY LOCKS

SARGENT®

PADLOCK-858

ASSA ABLOY

USA & Canada Prices Effective May 1, 2021

858 Padlock		
Option	Description	Price
10	SARGENT Signature System	Add \$63.00 /cyl
*11	SARGENT XC Key System (not available with 10, 22, SC, SE options)	No addition
1160	Sargent XC Large Format Interchangeable Plastic Disposable Construction Core	No addition
1163	Sargent XC Large Format Interchangeable Core Cylinder - Includes masterkeying charges	\$83.00
1164	Sargent XC Large Format Interchangeable Construction Core Cylinder	\$83.00
*21	SARGENT Construction Key System (lost ball) Standard on all new systems est. since 5/1/96	Add \$16.00 /cyl
*22	SARGENT Construction Key System (split key) To be used on pre-est. split key systems only	Add \$32.00 /cyl
*51	SARGENT Old Style Removable Core	Add \$85.00 /cyl
*52	SARGENT Old Style Construction Removable Core	\$83.00
60	SARGENT Large Format Interchangeable Plastic Disposable Construction Core	No addition
63	SARGENT Large Format IC Core Cylinder includes master and grandmaster keying charge	Add \$83.00 /cyl
64	SARGENT Large Format Interchangeable Construction Core Cylinder	\$83.00
DG1	Patented Degree DG1 Key System	No addition
DG160	Hardware prepared for DG1-6300 Lg. Format IC cores, supplied with temporary plastic construction cores	No addition
DG163	Patented Degree DG1 Large Format Interchangeable Core Cylinder - Includes master keying charges	\$83.00
DG164	Hardware prepared for DG1-6300 Lg. Format IC cores, supplied with temporary keyed construction cores	\$83.00
DG2	Patented Degree DG2 Key System incorporating a locking sidebar	\$63.00/cyl.
DG260	Hardware prepared for DG2-6300 Lg. Format IC cores, supplied with temporary plastic construction cores	No addition
DG263	Patented Degree DG2 Large Format Interchangeable Core Cylinder - Includes master keying charges	\$146.00
DG264	Hardware prepared for DG2-6300 Lg. Format IC cores, supplied with temporary keyed construction cores	\$83.00
DG3	Patented Degree DG3 Key System incorporating a locking sidebar and UL437 listed	\$89.00/cyl.
DG360	Hardware prepared for DG3-6300 Lg. Format IC cores, supplied with temporary plastic construction cores	No addition
DG363	Patented Degree DG3 Large Format Interchangeable Core Cylinder - Includes master keying charges	\$172.00
DG364	Hardware prepared for DG3-6300 Lg. Format IC cores, supplied with temporary keyed construction cores	\$83.00
LC	Less Cylinder	-\$21.00/cyl.
SC	Schlage "C" Keyway Cylinder - O Bitted	No Add
SE	Schlage "E" Keyway Cylinder - O Bitted	No Add

* Refer to CK-3 for additional master keying charges when using this option

Padlock		Price
Number		
858	Non Key retaining Padlock	\$130.00
Shackle Types and Suffixes		
Heights: 1"-Standard, 2" (-2 suffix), & 4" (-4 suffix)		N/C
Material: Stainless – Standard, Optional Hardened Steel (HS suffix)		N/C
Chain specify -C suffix		\$2.00

Cylinders & Parts			
Option	Number	Description	Price
	6300	SARGENT Removable Core	\$83.00
65	6300	SARGENT Removable Core Unassembled	\$73.00
10-21	C750-1	Standard 6 pin cylinder and tail piece with Signature & construction keying (10, 21 options)	\$190.00
21	C750-1	Standard 6 pin cylinder and tail piece assy. But (construction keying) 21 option lost ball	\$127.00
	C750-1	758/858 Cylinder & Tailpiece Assembly	\$95.00
SE	C750-1	Standard 6 pin cylinder and tail pice with Schlage E keyway (0-bitted)	\$95.00
SC	C750-1	Standard 6 pin cylinder and tail pice with Schlage C keyway (0-bitted)	\$95.00
10	C750-1	Standard 6 pin cylinder and tail piece with Signature Feature (10 option)	\$158.00
	01-9219	858 Cylinder retainer screw	\$5.82
	13-1230	Tail piece only for standard cylinder, 10- and 21- cylinders	\$2.07
	17-2633	858 Cylinder Retainer & Screw Pack	\$15.65
	17-2006	9 inch chain (C suffix when ordering complete padlock) optional	\$28.19

Experience a safer
and more open world

Copyright © 2002-2021 Sargent Manufacturing Company, an ASSA ABLOY Group company. All rights reserved.
Reproduction in whole or in part without the express written permission of Sargent Manufacturing Company is prohibited.
Contact us at: 800-727-5477 or visit www.sargentlock.com. In Canada contact us at: 800-461-3007 or visit www.assaabloydss.ca

HEALTHCARE HARDWARE

HP Series Tubular Lock with Push/Pull (ALP) Trim & Options...	SP-1
114/115 Series with Push/Pull Trim & Options	SP-2
114/115 Push/Pull Parts.....	SP-3
8200 Series PUSH/PULL Trim (ALP) Options	SP-4
8200 Series PUSH/PULL Trim (ALP)	SP-5
8200 Series Behavioral Health Trim (BHL) Options	SP-6
8200 Series Behavioral Health Trim (BHL).....	SP-7
8200 Series Behavioral Health Trim (BHW) Options	SP-8
8200 Series Behavioral Health Trim (BHW)	SP-9
7800 Series Push/Pull Trim(PT) Options	SP-10
7800 Series Push/Pull Trim(PT).....	SP-11
7800 Series Knob Trim(BHD) Options.....	SP-12
7800 Series Knob Trim(BHD)	SP-13
7800 Series (BHD) Inside Trim, Outside Trim	SP-14

SARGENT®

ASSA ABLOY

SP-1 HEALTHCARE HARDWARE

HP SERIES TUBULAR LOCK WITH PUSH/PULL (ALP) TRIM & OPTIONS

USA & Canada Prices Effective May 1, 2021

How to order:

SG-HPU65 x ALP x 32D x RHR

Option SG
Function HPU65
Trim ALP
Finish 32D

Specify hand when ordering
15 function is field reversible



ALP

Options	Description	Price
14	505 Full Lip Strike	No addition
24	2-3/4" Backset	No addition
26	7" Backset	\$6.00
28	4-7/8" (124mm) ANSI curved lip strike #808	No addition
31	1-3/4" to 2-1/4" door thick door – only centered in door	No addition
36	6 Lobe security head screws	\$24.00
37	Spanner head screws	\$17.00
74	Lead lined (Specify Push or Pull side)	\$249.00
P-	Push/Pull – Field installed	\$25.00
SG	MicroShield® an antimicrobial powder coat finish	\$42.00
WBS	Wrought Box Strike	No Addition
CPC	Clear Powder Coat	\$67.00

Function	Description	Finish 32D
HPU15	Passage	\$491.00
HPU65	Privacy	\$638.00

Experience a safer
and more open world

Copyright © 2002-2021 Sargent Manufacturing Company, an ASSA ABLOY Group company. All rights reserved.
Reproduction in whole or in part without the express written permission of Sargent Manufacturing Company is prohibited.
Contact us at: 800-727-5477 or visit www.sargentlock.com. In Canada contact us at: 800-461-3007 or visit www.assaabloydss.ca

SP-2 HEALTHCARE HARDWARE

SARGENT®

114/115 SERIES PUSH/PULL TRIM & OPTIONS

ASSA ABLOY

USA & Canada Prices Effective May 1, 2021



114 Push-Pull

Specify LH or LHR or RH or RHR

Options	Description	Price
24	2-3/4" Backset	No addition
26	7" Backset	\$6.00
28	ANSI Strike #808	No addition
36	6-Lobe Security Head Screws	\$24.00
37	Spanner Head Screws	\$17.00
74	Lead lined (Specify Push or Pull side)	\$249.00
P-	Engraved Paddles "Push" and "Pull"	\$25.00
SG	MicroShield® an antimicrobial powder coat finish	\$42.00
TB	Thru-bolt	\$33.95
WBS	Wrought Box Strike	No Addition

Hospital Latch		Finish		
Number	Description	10BE/26D	10/26	03/04/15/10B
114	5" Backset			
115	5" Backset	\$511.00	\$530.00	\$622.00

Thru-Bolt Packs-114/115		Price
21-2223 (4/pack)	for 1-3/4" door	per pack \$33.95
21-2224 (4/pack)	for 2" door	per pack \$37.91
21-2225 (4/pack)	for 2-1/4" door	per pack \$41.71

Note: Thru-Bolts are not standard with hospital latches. Please specify x thru-bolts, if required.

CPC Clear Powder Coat over 26D – How to order: 115 x 26D x LH x CPC Add \$67.00
All orders will continue to be handled as a "special" when CPC is required

Experience a safer
and more open world

Copyright © 2002-2021 Sargent Manufacturing Company, an ASSA ABLOY Group company. All rights reserved.
Reproduction in whole or in part without the express written permission of Sargent Manufacturing Company is prohibited.
Contact us at: 800-727-5477 or visit www.sargentlock.com. In Canada contact us at: 800-461-3007 or visit www.assaabloydss.ca

114/115 SERIES PUSH/PULL PARTS

USA & Canada Prices Effective May 1, 2021

114	115	Part #	Description	Price
X	X	01-0697	Spiral Pin	\$1.07
X	X	01-0997	Spiral Pin (After 11/6/92)	\$0.78
X	X	01-1153	Active Adjusting Screw	\$3.18
X	X	*21-0156	Cover (plain)	\$100.19
X	X	21-0214	Cam Screw	\$6.36
	X	21-0246	Bumper	\$3.18
X	X	21-0249	Main Pivot	\$6.36
	X	*21-0306	Cover (push)	\$115.50
X	X	*21-0307	Cover (pull)	\$115.50
X		21-0460	Spring	\$7.49
X		21-0461	Cam (push)	\$31.22
X		21-0462	Cam (pull)	\$31.22
X		21-0465	Pin (spring)	\$2.62
X		*21-0468	Cover (push)	\$115.50
X	X	21-0510	Chassis (push & pull)	\$217.62
X		*21-0514	Pull Handle	\$202.63
X		*21-0515	Push Handle	\$202.63
	X	*21-0516	Pull Handle	\$217.62
	X	*21-0517	Push Handle	\$217.62
	X	21-2039	Cam & Spring Assembly	\$46.77
	X	*21-2046	LH Pull Handle Assembly. less cover	\$378.53
	X	*21-2047	RH Pull Handle Assembly. less cover	\$378.53
X	X	21-2055	Screw Pack	\$22.79
	X	*21-2058	LH Push Handle Assembly. less cover	\$395.71
	X	*21-2059	RH Push Handle Assembly. less cover	\$395.71
X	X	21-2223	Thrubolt Sleeve 1-3/4" Door	\$33.95 per pkg.
X	X	21-2224	Thrubolt Sleeve 2" Door	\$37.91 per pkg.
X	X	21-2225	Thrubolt Sleeve 2-1/4" Door	\$41.71 per pkg.
X		*21-2333	LH Push Handle Assembly. less cover	\$378.52
X		*21-2334	RH Push Handle Assembly. less cover	\$378.52
X	X	*21-2339	Latch Assembly - 5" Backset	\$234.67
X	X	*21-2340	Latch Assembly - 7" Backset	\$249.96
X		*21-2343	LH Pull Handle Assembly. less cover	\$378.53
X		*21-2344	RH Pull Handle Assembly. less cover	\$378.53
X	X	*21-2360	Latch Assembly - 2-3/4" Backset	\$217.62
		21-2381	Fire Shield & Spacer Assembly	\$25.43
		21-2383	Fire Shield Pack	\$45.57

*Specify hardware finish. Consult catalog for available finishes.

OPTIONS

USA & Canada Prices Effective May 1, 2021

Options	Description	Price
10▲	SARGENT Signature Key System	\$63.00 / cyl.
11†▲	SARGENT XC Key System (not available with 10, 22, SC, SE options)	No addition
1160	SARGENT XC Large Format Interchangeable Plastic Disposable Construction Core	No addition
1163	SARGENT XC Large Format Interchangeable Core Cylinder - Includes masterkeying charges	\$83.00
1164	SARGENT XC Large Format Interchangeable Construction Core Cylinder	\$83.00
1170	Small Format interchangeable disposable construction core - to accept 7 Pin XC permanent core	No addition
11727P	Small Format interchangeable keyed construction core - to accept 7 Pin XC permanent core	\$75.00
11737P	Small Format interchangeable core - to accept 7 pin XC permanent core	\$75.00/cyl.
21▲†	SARGENT Construction Key System (lost ball) Standard on all new systems established since 5/1/96	\$16.00 / cyl.
22▲†	SARGENT Construction Key System (split key) To be used on pre-established split key systems only	\$32.00 / cyl.
23	Locksets with flat 4 7/8" ANSI strike	No addition
31	Thick Doors - Extended Lip Required - Specify Length C to E - Cylinders - IMPORTANT- See 8200 Push/Pull trim catalog option page for cylinder limitations - Below charges DO NOT include additional charges for special cylinder requirements Doors up to 2-1/4" thick - lock centered - IF PANNELED – must specify panel thickness & panel location (inside or outside) For example: Specify 1-3/4" door with panel (Side) on inside or outside For doors thicker than 2-1/4" - consult factory	No addition Non Keyed function \$50.00 Keyed function \$100.00
36	6 Lobe security head screws	\$24.00
37	Spanner head screws	\$17.00
49	Visual Status Indicator - Available with 30 & 37 functions	\$140.00
49	Occupancy indicator with emergency release - Available with 65, 66, & 68 functions	\$140.00
50	Secured indicator - Available with 24, 25, 26, 28,29, 30, 36, 37, 38, 39, 40, 41, 43, 45, 50, 51, 52, & 67 functions	\$140.00
60	SARGENT Large Format Interchangeable Plastic Disposable Construction Core	No addition
63	SARGENT Large Format Interchangeable core cylinder, includes master keying charges	\$83.00 / cyl.
64	SARGENT Large Format Interchangeable Construction Core Cylinder	\$83.00
6573▲†	Small Format 6-Pin Uncombined Core (Refer to CK-12)	\$65.00 / cyl.
65737P▲†	Small Format 7-Pin Uncombined Core (Refer to CK-12)	\$65.00 / cyl.
70▲†	Small Format Interchangeable disposable plastic construction core	No addition
72▲†	Small Format Interchangeable 6-pin construction core (7-pin with 11 option)	\$75.00
73▲†	Small Format interchangeable core 6-pin Includes MK and GMK keying charges	\$75.00 / cyl
737P▲†	Small Format interchangeable core 7-pin (refer to CK-12 for available keyways) Includes MK and GMK keying charges	\$75.00 / cyl
74*	Lead Lining or Wrapping	\$294.00
81▲†	Cylinder to accept Keso (83) and Keso F1 (F183) removable core – no core provided	No addition
F182†	SARGENT Keso Security Cylinder – patented – new key systems	\$91.00 / cyl.
F183▲†	SARGENT Keso Security Removable Core Cylinder – patented – new key systems	\$130.00 / cyl.
82†	SARGENT Keso Security Cylinder (For existing systems only)	\$91.00 / cyl.
83▲†	SARGENT Keso Security Removable Core Cylinder (For existing systems only)	\$130.00 / cyl.
84▲†	SARGENT Keso Security Removable Construction Core Cylinder	See CK-18
BR	SARGENT Bump Resistant Cylinders (N/A w/10, 22, 30, 60, 63, 64, 70, 72, 73, 737P, KESO, SC, & SE options)	\$25.00 /cyl.
DG1	Patented Degree DG1 Key System	No addition
DG160	Hardware prepared for DG1-6300 Lg. Format IC cores, supplied with temporary plastic construction cores	No addition
DG163	Patented Degree DG1 Large Format Interchangeable Core Cylinder - Includes master keying charges	\$83.00
DG164	Hardware prepared for DG1-6300 Lg. Format IC cores, supplied with temporary keyed construction cores	\$83.00
DG2	Patented Degree DG2 Key System incorporating a locking sidebar	\$63.00/cyl.
DG260	Hardware prepared for DG2-6300 Lg. Format IC cores, supplied with temporary plastic construction cores	No addition
DG263	Patented Degree DG2 Large Format Interchangeable Core Cylinder - Includes master keying charges	\$146.00
DG264	Hardware prepared for DG2-6300 Lg. Format IC cores, supplied with temporary keyed construction cores	\$83.00
DG3	Patented Degree DG3 Key System incorporating a locking sidebar and UL437 listed	\$89.00/cyl.
DG360	Hardware prepared for DG3-6300 Lg. Format IC cores, supplied with temporary plastic construction cores	No addition
DG363	Patented Degree DG3 Large Format Interchangeable Core Cylinder - Includes master keying charges	\$172.00
DG364	Hardware prepared for DG3-6300 Lg. Format IC cores, supplied with temporary keyed construction cores	\$83.00
LC	Less Cylinder	-\$96.00/cyl.
OBS	Open Back Strike	\$79.00
P-	Push/Pull – Field installed	\$25.00
SC▲†	Schlage "C" Keyway cylinder, (Number 41 Cylinder Only, 0 bitted)	No addition
SE▲†	Schlage "E" Keyway cylinder, (Number 41 Cylinder Only, 0 bitted)	No addition
SG	MicroShield® – an antimicrobial powder coat finish	\$75.00
WBS	Wrought Box Strike	No addition

▲ Options not available with a standard 50 function lockout cylinder.
† Not available with 60, 63, 64 options

CPC Clear Powder Coat over 32D. All orders will continue to be handled as a "special" when CPC is ordered.

\$67.00



ALP

8200 SERIES PUSH/PULL TRIM (ALP)

USA & Canada Prices Effective May 1, 2021

Function		Finish
Single Cyl		32D
8204	Storeroom or Closet	
8205	Office or Entry	
8237	Classroom	\$1,254.00
8255	Office or Entry	
8206	Storeroom or Service	
8231	Utility	
8236	Closet	\$1,276.00
8256	Office or Inner Entry	
8257, 8258, 8267	Institutional Privacy	
Single Cyl With Deadbolt		
8224	Room Door	
8225	Dormitory or Exit	
8227	Closet or Storeroom	
8228, 8230	Dummy Trim Deadlock	\$1,300.00
8235	Storeroom	
8243	Apartment Corridor	
8245	Dormitory or Exit	
8247	Front Door or Apartment Corridor	
8251	Storeroom Deadbolt	
8250	Hotel Guest Lock	\$1,329.00
Double Cyl No Deadbolt		
8216	Apartment or Exit or Public Toilet	
8217	Asylum or Institutional	\$1,349.00
8238	Classroom Security Intruder	
8242	Classroom Security Intruder Latchbolt	
8259	School Security	
Double Cyl With Deadbolt		
8226	Store Door	
8229	Dummy Trim Deadlock	\$1,367.00
8239, 8240	Classroom Security Intruder	
8241	Classroom Security	
8246	Dormitory or Exit	
8248	Store Door	
8249	Security Deadbolt	
8252	Institutional	
Electro Mechanical Single Cyl – Specify 12V or 24V		
8270-12V/8270-24V	Fail Safe	\$1,450.00
8271-12V/8271-24V	Fail Secure	
Electro Mechanical Double Cyl – Specify 12V or 24V		
8272-12V/8272-24V	Fail Safe	\$1,507.00
8273-12V/8273-24V	Fail Secure	
Non Keyed		
8213	Communication or Exit	\$1,103.00
8215	Passage or Closet	
8265	Privacy Bedroom or Bath (Latch)	\$1,198.00
8266, 8268	Privacy Bedroom or Bath (D.bolt)	\$1,232.00

LOCKBODIES ONLY - For ALP trim. For all other trimset lockbodies - refer to ML-93					
Part No.	Function	Price	Part No.	Function	Price
82-4850	04, 05, 06, 13, 17, 31, 36, 37, 38	\$427.00	82-4859	45, 46	\$465.00
82-4851	15	\$308.00	82-4860	47, 48	\$465.00
82-4852	16	\$427.00	82-4861	49	\$465.00
82-4853	24, 26, 27, 68	\$465.00	82-4862	50, 51, 52	\$465.00
82-4854	25, 35, 39, 66	\$465.00	82-4863	55	\$427.00
82-4855	28, 29, 30	\$465.00	82-4864	56	\$445.00
82-4856	40	\$465.00	82-4865	59	\$427.00
82-4857	41	\$465.00	82-4866	65	\$373.00
82-4858	43	\$465.00	82-4867	67	\$445.00

8200 ALP Positive Pull Stop Kit (Includes inside and outside trims)		
Part#	Function	32D
684	Positive Pull Stop Kit (Please specify handing)	\$37.00

Experience a safer
and more open world

8200 SERIES WITH BHL TRIM OPTIONS

USA & Canada Prices Effective May 1, 2021

Options	Description	Price
10▲	SARGENT Signature Key System	\$63.00 / cyl.
11†▲	SARGENT XC Key System (not available with 10, 22, SC, SE options)	No addition
1160	SARGENT XC Large Format Interchangeable Plastic Disposable Construction Core	No addition
1163	SARGENT XC Large Format Interchangeable Core Cylinder - Includes masterkeying charges	\$83.00
1164	SARGENT XC Large Format Interchangeable Construction Core Cylinder	\$83.00
1170	Small Format interchangeable disposable construction core - to accept 7 Pin XC permanent core	No addition
11727P	Small Format interchangeable keyed construction core - to accept 7 Pin XC permanent core	\$75.00
11737P	Small Format interchangeable core - to accept 7 pin XC permanent core	\$75.00 / cyl.
21▲†	SARGENT Construction Key System (lost ball) Standard on all new systems established since 5/1/96	\$16.00 / cyl.
22▲†	SARGENT Construction Key System (split key) To be used on pre-established split key systems only	\$32.00 / cyl.
23	Locksets with flat 4 7/8" ANSI strike	No addition
31	Thick Doors - Extended Lip Required - Specify Length C to E – Cylinders - IMPORTANT- See 8200 Push/Pull trim catalog option page for cylinder limitations – Below charges DO NOT include additional charges for special cylinder requirements Doors up to 2-1/4" thick - lock centered – IF PANNELED – must specify panel thickness & panel location (inside or outside) For example: Specify 1-3/4" door with panel (Side) on inside or outside	No addition
		Non Keyed function \$50.00
		Keyed function \$100.00
37	Spanner head screws	\$17.00
60	SARGENT Large Format Interchangeable Plastic Disposable Construction Core	No addition
63	SARGENT Large Format Interchangeable core cylinder, includes master keying charges	\$83.00 / cyl.
64	SARGENT Large Format Interchangeable Construction Core Cylinder	\$83.00
6573▲†	Small Format 6-Pin Uncombined Core (Refer to CK-12)	\$65.00 / cyl.
65737P▲†	Small Format 7-Pin Uncombined Core (Refer to CK-12)	\$65.00 / cyl.
70▲†	Small Format Interchangeable disposable plastic construction core	No addition
72▲†	Small Format Interchangeable 6-pin construction core (7-pin with 11 option)	\$75.00
73▲†	Small Format interchangeable core 6-pin Includes MK and GMK keying charges	\$75.00 / cyl
737P▲†	Small Format interchangeable core 7-pin (refer to CK-12 for available keyways) Includes MK and GMK keying charges	\$75.00 / cyl
74*	Lead Lining or Wrapping	\$294.00
81▲†	Cylinder to accept Keso (83) and Keso F1 (F183) removable core – no core provided	No addition
F182†	SARGENT Keso Security Cylinder – patented – new key systems	\$91.00 / cyl.
F183▲†	SARGENT Keso Security Removable Core Cylinder – patented – new key systems	\$130.00 / cyl.
82†	SARGENT Keso Security Cylinder (For existing systems only)	\$91.00 / cyl.
83▲†	SARGENT Keso Security Removable Core Cylinder (For existing systems only)	\$130.00 / cyl.
84▲†	SARGENT Keso Security Removable Construction Core Cylinder	See CK-18
BR	SARGENT Bump Resistant Cylinders (N/A w/10, 22, 30, 60, 63, 64, 70, 72, 73, 737P, KESO, SC, & SE options)	\$25.00 / cyl.
DG1	Patented Degree DG1 Key System	No addition
DG160	Hardware prepared for DG1-6300 Lg. Format IC cores, supplied with temporary plastic construction cores	No addition
DG163	Patented Degree DG1 Large Format Interchangeable Core Cylinder - Includes master keying charges	\$83.00
DG164	Hardware prepared for DG1-6300 Lg. Format IC cores, supplied with temporary keyed construction cores	\$83.00
DG2	Patented Degree DG2 Key System incorporating a locking sidebar	\$63.00/cyl.
DG260	Hardware prepared for DG2-6300 Lg. Format IC cores, supplied with temporary plastic construction cores	No addition
DG263	Patented Degree DG2 Large Format Interchangeable Core Cylinder - Includes master keying charges	\$146.00
DG264	Hardware prepared for DG2-6300 Lg. Format IC cores, supplied with temporary keyed construction cores	\$83.00
DG3	Patented Degree DG3 Key System incorporating a locking sidebar and UL437 listed	\$89.00/cyl.
DG360	Hardware prepared for DG3-6300 Lg. Format IC cores, supplied with temporary plastic construction cores	No addition
DG363	Patented Degree DG3 Large Format Interchangeable Core Cylinder - Includes master keying charges	\$172.00
DG364	Hardware prepared for DG3-6300 Lg. Format IC cores, supplied with temporary keyed construction cores	\$83.00
DX	Deadbolt monitoring (not available with LX-)	\$197.00
LC	Less Cylinder	-\$96.00/cyl.
LX	Latchbolt monitor	\$200.00
OBS	Open Back Strike	\$79.00
SC▲†	Schlage "C" Keyway cylinder, (Number 41 Cylinder Only, 0 bitted)	No addition
SE▲†	Schlage "E" Keyway cylinder, (Number 41 Cylinder Only, 0 bitted)	No addition
SG	MicroShield® – an antimicrobial powder coat finish	\$75.00
WBS	Wrought Box Strike	No addition

▲ Options not available with a standard 50 function lockout cylinder.

† Not available with 60, 63, 64 options

CPC Clear Powder Coat over 32D. All orders will continue to be handled as a "special" when CPC is ordered.

\$67.00

8200 SERIES WITH BHL TRIM



BHL

USA & Canada Prices Effective May 1, 2021

Function		Finish
Single Cyl		32D
8204	Storeroom or Closet	
8205	Office or Entry	\$1,911.00
8237	Classroom	
8256	Office or Inner Entry	
8257, 8258, 8267	Institutional Privacy	\$1,938.00
Single Cyl With Deadbolt		
8224	Room Door	
8225	Dormitory or Exit	\$1,967.00
8227	Closet or Storeroom	
Double Cyl No Deadbolt		
8216	Apartment or Exit or Public Toilet	
8217	Asylum or Institutional	\$2,017.00
8238	Classroom Security Intruder	
8242	Classroom Security Intruder Latchbolt	
Double Cyl With Deadbolt		
8226	Store Door	\$2,039.00
8239, 8240	Classroom Security Intruder	
Electro Mechanical Single Cyl – Specify 12V or 24V		
8270-12V/8270-24V	Fail Safe	\$2,107.00
8271-12V/8271-24V	Fail Secure	
Electro Mechanical Double Cyl – Specify 12V or 24V		
8272-12V/8272-24V	Fail Safe	\$2,164.00
8273-12V/8273-24V	Fail Secure	
Non Keyed		
8215	Passage or Closet	\$1,710.00
8265	Privacy Bedroom or Bath (Latch)	\$1,795.00
8266	Privacy Bedroom or Bath (Deadbolt)	\$1,886.00

LOCKBODIES ONLY - For BHL trim. For all other trimset lockbodies - refer to ML-93					
Part No.	Function	Price	Part No.	Function	Price
82-3117	15	\$337.00	82-5243	8270/71	\$736.00
82-3121	16	\$456.00	82-5247	8272/73	\$736.00
82-3149	25, 39, 66	\$492.00	82-3774	8240	\$492.00
82-3153	24, 26, 27	\$492.00	82-4273	8256	\$474.00
82-3169	04, 05, 17, 37, 38	\$456.00	82-4274	8267	\$474.00
82-3185	65	\$401.00			

**8200 SERIES BEHAVIORAL HEALTH
(BHW) TRIM OPTIONS**

USA & Canada Prices Effective May 1, 2021

Options	Description	Price
10▲	SARGENT Signature Key System	\$63.00 / cyl.
11†▲	SARGENT XC Key System (not available with 10, 22, SC, SE options)	No addition
1160	SARGENT XC Large Format Interchangeable Plastic Disposable Construction Core	No addition
1163	SARGENT XC Large Format Interchangeable Core Cylinder - Includes masterkeying charges	\$83.00
1164	SARGENT XC Large Format Interchangeable Construction Core Cylinder	\$83.00
1170	Small Format interchangeable disposable construction core - to accept 7 Pin XC permanent core	No addition
11727P	Small Format interchangeable keyed construction core - to accept 7 Pin XC permanent core	\$75.00
11737P	Small Format interchangeable core - to accept 7 pin XC permanent core	\$75.00 /cyl.
21▲†	SARGENT Construction Key System (lost ball) Standard on all new systems established since 5/1/96	\$16.00 / cyl.
22▲†	SARGENT Construction Key System (split key) To be used on pre-established split key systems only	\$32.00 / cyl.
23	Locksets with flat 4 7/8" ANSI strike	No addition
31	Thick Doors - Extended Lip Required - Specify Length C to E – Cylinders - IMPORTANT- See 8200 Push/Pull trim catalog option page for cylinder limitations – Below charges DO NOT include additional charges for special cylinder requirements Doors up to 2-1/4" thick - lock centered – IF PANNELED – must specify panel thickness & panel location (inside or outside) For example: Specify 1-3/4" door with panel (Side) on inside or outside For doors thicker than 2-1/4" - consult factory	No addition Non Keyed function \$50.00 Keyed function \$100.00
60	SARGENT Large Format Interchangeable Plastic Disposable Construction Core	No addition
63	SARGENT Large Format Interchangeable core cylinder, includes master keying charges	\$83.00 / cyl.
64	SARGENT Large Format Interchangeable Construction Core Cylinder	\$83.00
6573▲†	Small Format 6-Pin Uncombined Core (Refer to CK-12)	\$65.00 / cyl.
65737P▲†	Small Format 7-Pin Uncombined Core (Refer to CK-12)	\$65.00 / cyl.
70▲†	Small Format Interchangeable disposable plastic construction core	No addition
72▲†	Small Format Interchangeable 6-pin construction core (7-pin with 11 option)	\$75.00
73▲†	Small Format interchangeable core 6-pin Includes MK and GMK keying charges	\$75.00 / cyl
737P▲†	Small Format interchangeable core 7-pin (refer to CK-12 for available keyways) Includes MK and GMK keying charges	\$75.00 / cyl
74*	Lead Lining or Wrapping	\$294.00
81▲†	Cylinder to accept Keso (83) and Keso F1 (F183) removable core – no core provided	No addition
F182†	SARGENT Keso Security Cylinder – patented – new key systems	\$91.00 / cyl.
F183▲†	SARGENT Keso Security Removable Core Cylinder – patented – new key systems	\$130.00 / cyl.
82†	SARGENT Keso Security Cylinder (For existing systems only)	\$91.00 / cyl.
83▲†	SARGENT Keso Security Removable Core Cylinder (For existing systems only)	\$130.00 / cyl.
84▲†	SARGENT Keso Security Removable Construction Core Cylinder	See CK-18
BR	SARGENT Bump Resistant Cylinders (N/A w/10, 22, 30, 60, 63, 64, 70, 72, 73, 737P, KESO, SC, & SE options)	\$25.00 /cyl.
DG1	Patented Degree DG1 Key System	No addition
DG160	Hardware prepared for DG1-6300 Lg. Format IC cores, supplied with temporary plastic construction cores	No addition
DG163	Patented Degree DG1 Large Format Interchangeable Core Cylinder - Includes master keying charges	\$83.00
DG164	Hardware prepared for DG1-6300 Lg. Format IC cores, supplied with temporary keyed construction cores	\$83.00
DG2	Patented Degree DG2 Key System incorporating a locking sidebar	\$63.00/cyl.
DG260	Hardware prepared for DG2-6300 Lg. Format IC cores, supplied with temporary plastic construction cores	No addition
DG263	Patented Degree DG2 Large Format Interchangeable Core Cylinder - Includes master keying charges	\$146.00
DG264	Hardware prepared for DG2-6300 Lg. Format IC cores, supplied with temporary keyed construction cores	\$83.00
DG3	Patented Degree DG3 Key System incorporating a locking sidebar and UL437 listed	\$89.00/cyl.
DG360	Hardware prepared for DG3-6300 Lg. Format IC cores, supplied with temporary plastic construction cores	No addition
DG363	Patented Degree DG3 Large Format Interchangeable Core Cylinder - Includes master keying charges	\$172.00
DG364	Hardware prepared for DG3-6300 Lg. Format IC cores, supplied with temporary keyed construction cores	\$83.00
DX	Deadbolt Monitoring (notavailable with 50, 74)	\$197.00
LC	Less Cylinder	-\$96.00/cyl.
LX	Latchbolt Monitor – Monitors latchbolt position (not available with deadbolt functions)	\$200.00
OBS	Open Back Strike	\$79.00
RX	Request to Exit	\$206.00
SC▲†	Schlage "C" Keyway cylinder, (Number 41 Cylinder Only, 0 bitted)	No addition
SE▲†	Schlage "E" Keyway cylinder, (Number 41 Cylinder Only, 0 bitted)	No addition
SG	MicroShield® – an antimicrobial powder coat finish	\$75.00
WBS	Wrought Box Strike	No addition

▲ Options not available with a standard 50 function lockout cylinder.

† Not available with 60, 63, 64 options

CPC Clear Powder Coat over 32D. All orders will continue to be handled as a "special" when CPC is ordered.

\$67.00



8200 SERIES BEHAVIORAL HEALTH TRIM (BHW)

BHW

USA & Canada Prices Effective May 1, 2021

Function		Finish
Single Cyl		32D
8204	Storeroom or Closet	
8205	Office or Entry	
8237	Classroom	\$1,976.00
8255	Office or Entry	
8256	Office or Inner Entry	
8257, 8258, 8267	Institutional Privacy	\$2,001.00
Single Cyl With Deadbolt		
8224	Room Door	
8225	Dormitory or Exit	
8227	Closet or Storeroom	
8228, 8230	Dummy Trim Deadlock	\$2,027.00
8243	Apartment Corridor	
8245	Dormitory or Exit	
8247	Front Door or Apartment Corridor	
8251	Storeroom Deadbolt	
8250	Hotel Guest Lock	\$2,061.00
Double Cyl No Deadbolt		
8216	Apartment or Exit or Public Toilet	
8217	Asylum or Institutional	
8238	Classroom Security Intruder	\$2,076.00
8242	Classroom Security Intruder Latchbolt	
8259	School Security	
Double Cyl With Deadbolt		
8226	Store Door	
8229	Dummy Trim Deadlock	
8239, 8240	Classroom Security Intruder	
8241	Classroom Security	\$2,083.00
8246	Dormitory or Exit	
8248	Store Door	
8249	Security Deadbolt	
8252	Institutional	
Electro Mechanical Single Cyl – Specify 12V or 24V		
8270-12V/8270-24V	Fail Safe	\$2,172.00
8271-12V/8271-24V	Fail Secure	
Electro Mechanical Double Cyl – Specify 12V or 24V		
8272-12V/8272-24V	Fail Safe	\$2,229.00
8273-12V/8273-24V	Fail Secure	
Non Keyed		
8215	Passage or Closet	\$1,841.00
8265	Privacy Bedroom or Bath (Latch)	\$1,898.00
8266, 8268	Privacy Bedroom or Bath (D.bolt)	\$1,960.00

Note: Lockbodies only for BHW trim, refer to page ML-93

8200 BHW Trim Kits (Includes inside and outside trims)		
Part#	Function	32D
694-1 BHW	15, 65, 66, 68	\$1,225.00
694-2 BHW	04, 05, 24, 25, 27, 28, 30, 37, 43, 45, 47, 50, 51, 55, 56, 67, 70, 71	\$1,417.00
694-3 BHW	16, 17, 26, 29, 38, 39, 40, 41, 46, 48, 49, 52, 59, 72, 73	\$1,378.00

OPTIONS

USA & Canada Prices Effective May 1, 2021

Options	Description	Price
10	SARGENT Signature Key System	\$63.00 / cyl.
11†▲	SARGENT XC Key System (not available with 10, 22, SC, SE options)	No addition
1160	SARGENT XC Large Format Interchangeable Plastic Disposable Construction Core	No addition
1163	SARGENT XC Large Format Interchangeable Core Cylinder - Includes masterkeying charges	\$83.00
1164	SARGENT XC Large Format Interchangeable Construction Core Cylinder	\$83.00
1170	Small Format interchangeable disposable construction core - to accept 7 Pin XC permanent core	No addition
11727P	Small Format interchangeable keyed construction core - to accept 7 Pin XC permanent core	\$75.00
11737P	Small Format interchangeable core - to accept 7 pin XC permanent core	\$75.00 / cyl.
21▲†	SARGENT Construction Key System (lost ball) Standard on all new systems established since 5/1/96	\$16.00 / cyl.
22▲†	SARGENT Construction Key System (split key) To be used on pre-established split key systems only	\$32.00 / cyl.
23	Locksets with flat 4-7/8" ANSI strike	No addition
37	Spanner head screws	\$17.00
60	SARGENT Large Format Interchangeable Plastic Disposable Construction Core	No addition
63	SARGENT Large Format Interchangeable core cylinder, includes master keying charges	\$83.00 / cyl.
64	SARGENT Large Format Interchangeable Construction Core Cylinder	\$83.00
6573▲†	Small Format 6-Pin Uncombined Core (Refer to CK-12)	\$65.00 / cyl.
65737P▲†	Small Format 7-Pin Uncombined Core (Refer to CK-12)	\$65.00 / cyl.
70▲†	Small Format Interchangeable disposable plastic construction core	No addition
72▲†	Small Format Interchangeable 6-pin construction core (7-pin with 11 option)	\$75.00
73▲†	Small Format interchangeable core 6-pin Includes MK and GMK keying charges	\$75.00 / cyl
737P▲†	Small Format interchangeable core 7-pin (refer to CK-12 for available keyways) Includes MK and GMK keying charges	\$75.00 / cyl
74	Lock case wrapped in lead – handling required	\$294.00
81▲†	Cylinder to accept Keso (83) and Keso F1 (F183) removable core – no core provided	No addition
F182†	SARGENT Keso Security Cylinder – patented – new key systems	\$91.00 / cyl.
F183▲†	SARGENT Keso Security Removable Core Cylinder – patented – new key systems	\$130.00 / cyl.
82†	SARGENT Keso Security Cylinder (For existing systems only)	\$91.00 / cyl.
83▲†	SARGENT Keso Security Removable Core Cylinder (For existing systems only)	\$130.00 / cyl.
84▲†	SARGENT Keso Security Removable Construction Core Cylinder	See CK-18
BR	SARGENT Bump Resistant Cylinders (N/A w/10, 22, 30, 60, 63, 64, 70, 72, 73, 737P, KESO, SC, & SE options)	\$25.00 /cyl.
DG1	Patented Degree DG1 Key System	No addition
DG160	Hardware prepared for DG1-6300 Lg. Format IC cores, supplied with temporary plastic construction cores	No addition
DG163	Patented Degree DG1 Large Format Interchangeable Core Cylinder - Includes master keying charges	\$83.00
DG164	Hardware prepared for DG1-6300 Lg. Format IC cores, supplied with temporary keyed construction cores	\$83.00
DG2	Patented Degree DG2 Key System incorporating a locking sidebar	\$63.00/cyl.
DG260	Hardware prepared for DG2-6300 Lg. Format IC cores, supplied with temporary plastic construction cores	No addition
DG263	Patented Degree DG2 Large Format Interchangeable Core Cylinder - Includes master keying charges	\$146.00
DG264	Hardware prepared for DG2-6300 Lg. Format IC cores, supplied with temporary keyed construction cores	\$83.00
DG3	Patented Degree DG3 Key System incorporating a locking sidebar and UL437 listed	\$89.00/cyl.
DG360	Hardware prepared for DG3-6300 Lg. Format IC cores, supplied with temporary plastic construction cores	No addition
DG363	Patented Degree DG3 Large Format Interchangeable Core Cylinder - Includes master keying charges	\$172.00
DG364	Hardware prepared for DG3-6300 Lg. Format IC cores, supplied with temporary keyed construction cores	\$83.00
LC	Less Cylinder	-\$96.00/cyl.
OBS	Open Back Strike	\$79.00
SC▲†	Schlage "C" Keyway cylinder, (Number 41 Cylinder Only, 0 bitted)	No addition
SE▲†	Schlage "E" Keyway cylinder, (Number 41 Cylinder Only, 0 bitted)	No addition
SG	MicroShield® – an antimicrobial powder coat finish	\$75.00
WBS	Wrought Box Strike	No addition

▲ Options not available with standard 50 function lockout cylinder.

† Not available with 60, 63, 64 options.

7800 SERIES PUSH/PULL TRIM (PT)



7837 PT

USA & Canada Prices Effective May 1, 2021

Function Single Cyl		Finish	
		10BE/32D	03/04/09/10/10B/10BL/20D/32
7804	Storeroom or Closet	\$1,388.00	\$1,412.00
7837	Classroom		
Single Cyl With Deadbolt			
7824	Room Door	\$1,438.00	\$1,462.00
7843	Apartment Corridor		
7845	Dormitory or Exit	\$1,471.00	\$1,495.00
7850	Hotel Guest Lock		
Double Cyl No Deadbolt			
7816	Apartment or Exit or Public Toilet	\$1,492.00	\$1,516.00
7817	Asylum or Institutional		
Double Cyl With Deadbolt			
7826	Store Door	\$1,512.00	\$1,536.00
Non Keyed			
7815	Passage or Closet	\$1,215.00	\$1,239.00
7865	Privacy Bedroom or Bath (Latch)	\$1,321.00	\$1,345.00

Note: All locks supplied standard with 4 each 6-lobe security head screws on escutcheons only.

LOCKBODIES ONLY - For "PT" trim. For all other trimset lockbodies, refer to ML-93.			
Part #	Function		Price
78-2814	04	Storeroom - Single Cylinder	\$328.00
78-2820	37	Classroom - Single Cylinder	
78-2818	24	Storeroom - Single Cylinder w/deadbolt	\$361.00
78-2821	43	Dwelling Entry - Single Cylinder w/deadbolt	
78-2822	45	Dwelling Entry - Single Cylinder w/deadbolt	\$361.00
78-2823	50	Hotel - Single Cylinder w/Deadbolt	
78-2816	16	Public Entry - Double Cylinder	\$328.00
78-2817	17	Asylum - Double Cylinder	
78-2819	26	Storeroom - Double Cylinder w/Deadbolt	\$361.00
78-2815	15	Passage - Non-Keyed	\$212.00
78-2824	65	Privacy - Non-Keyed	\$286.00

Note: Outside Fronts, Strikes, Cylinders and Trim are NOT included with lockbody. Please order separately.

Inside and Outside Trim Sets			
Lock Function	Trim	10BE/32D	03/04/09/10/10B/10BL/20D/32
IS-7804 IS-7837	PT	\$657.00	\$689.00
IS-7815			
IS-7816 IS-7817 IS-7826	PT	\$671.00	\$700.00
IS-7824 IS-7843 IS-7850			
IS-7825 IS-7845 IS-7865	PT	\$697.00	\$732.00
Lock Function	Trim	10BE/32D	03/04/09/10/10B/10BL/20D/32
OS-7804 OS-7824 OS-7843	PT	\$689.00	\$723.00
OS-7816 OS-7826 OS-7845			
OS-7817 OS-7837 OS-7850			
OS-7815	PT	\$682.00	\$761.00
OS-7865	PT	\$709.00	\$740.00

Note: Must specify "Push" or "Pull" when ordering.

**7800 SERIES BEHAVIORAL HEALTH
KNOB TRIM (BHD) OPTIONS**

USA & Canada Prices Effective May 1, 2021

Options	Description	Price
1▲	7800 Line with 1-1/16" wide front for 1-3/8" doors.	\$62.00
10▲	SARGENT Signature Key System	\$63.00 / cyl.
11†▲	SARGENT XC Key System (not available with 10, 22, SC, SE options)	No addition
1160	SARGENT XC Large Format Interchangeable Plastic Disposable Construction Core	No addition
1163	SARGENT XC Large Format Interchangeable Core Cylinder - Includes masterkeying charges	\$83.00
1164	SARGENT XC Large Format Interchangeable Construction Core Cylinder	\$83.00
1170	Small Format interchangeable disposable construction core - to accept 7 Pin XC permanent core	No addition
11727P	Small Format interchangeable keyed construction core - to accept 7 Pin XC permanent core	\$75.00
11737P	Small Format interchangeable core - to accept 7 pin XC permanent core	\$75.00 / cyl.
21▲†	SARGENT Construction Key System (lost ball) Standard on all new systems established since 5/1/96	\$16.00 / cyl.
22▲†	SARGENT Construction Key System (split key) To be used on pre-established split key systems only	\$32.00 / cyl.
23	Locksets with flat 4-7/8" ANSI strike	No addition
31	Thick Doors - Extended Lip Required - Specify Length C to E - Cylinders - IMPORTANT- See catalog 7800/8200 option page for cylinder limitations - Below charges DO NOT include additional charges for special cylinder requirements Doors up to 2-1/2" thick - lock centered Doors 2-5/8" to 6" thick OR doors 1-3/4" thick w/max 1" paneling one side. For example: Specify 1-3/4" door with panel (Side) on inside or outside	No addition Non Keyed function \$50.00 Keyed function \$100.00
36	6 Lobe security head screws	\$24.00
37	Spanner head screws	\$17.00
60	SARGENT Large Format Interchangeable Plastic Disposable Construction Core	No addition
63	SARGENT Large Format Interchangeable core cylinder, includes master keying charges	\$83.00 / cyl.
64	SARGENT Large Format Interchangeable Construction Core Cylinder	\$83.00
6573▲†	Small Format 6-Pin Uncombined Core (Refer to CK-12)	\$65.00 / cyl.
65737P▲†	Small Format 7-Pin Uncombined Core (Refer to CK-12)	\$65.00 / cyl.
70▲†	Small Format Interchangeable disposable plastic construction core	No addition
72▲†	Small Format Interchangeable 6-pin construction core (7-pin with 11 option)	\$75.00
73▲†	Small Format interchangeable core 6-pin Includes MK and GMK keying charges	\$75.00 / cyl
737P▲†	Small Format interchangeable core 7-pin (refer to CK-12 for available keyways) Includes MK and GMK keying charges	\$75.00 / cyl
74	Lock case wrapped in lead – handing required (roses not available)	\$294.00
81▲†	Cylinder to accept Keso (83) and Keso F1 (F183) removable core – no core provided	No addition
F182†	SARGENT Keso Security Cylinder – patented – new key systems	\$91.00 / cyl.
F183▲†	SARGENT Keso Security Removable Core Cylinder – patented – new key systems	\$130.00 / cyl.
82†	SARGENT Keso Security Cylinder (For existing systems only)	\$91.00 / cyl.
83▲†	SARGENT Keso Security Removable Core Cylinder (For existing systems only)	\$130.00 / cyl.
84▲†	SARGENT Keso Security Removable Construction Core Cylinder	See CK-18
AV	Anti Vandal Pull Trim (available in 32D finish)	\$229.00
BR	SARGENT Bump Resistant Cylinders (N/A w/10, 22, 30, 60, 63, 64, 70, 72, 73, 737P, KESO, SC, & SE options)	\$25.00 /cyl.
DG1	Patented Degree DG1 Key System	No addition
DG160	Hardware prepared for DG1-6300 Lg. Format IC cores, supplied with temporary plastic construction cores	No addition
DG163	Patented Degree DG1 Large Format Interchangeable Core Cylinder - Includes master keying charges	\$83.00
DG164	Hardware prepared for DG1-6300 Lg. Format IC cores, supplied with temporary keyed construction cores	\$83.00
DG2	Patented Degree DG2 Key System incorporating a locking sidebar	\$63.00/cyl.
DG260	Hardware prepared for DG2-6300 Lg. Format IC cores, supplied with temporary plastic construction cores	No addition
DG263	Patented Degree DG2 Large Format Interchangeable Core Cylinder - Includes master keying charges	\$146.00
DG264	Hardware prepared for DG2-6300 Lg. Format IC cores, supplied with temporary keyed construction cores	\$83.00
DG3	Patented Degree DG3 Key System incorporating a locking sidebar and UL437 listed	\$89.00/cyl.
DG360	Hardware prepared for DG3-6300 Lg. Format IC cores, supplied with temporary plastic construction cores	No addition
DG363	Patented Degree DG3 Large Format Interchangeable Core Cylinder - Includes master keying charges	\$172.00
DG364	Hardware prepared for DG3-6300 Lg. Format IC cores, supplied with temporary keyed construction cores	\$83.00
DX	Deadbolt Monitoring (not available with 50, 74)	\$197.00
LC	Less Cylinder	-\$96.00/cyl.
OBS	Open Back Strike	\$79.00
SC▲†	Schlage "C" Keyway cylinder, (Number 41 Cylinder Only, 0-bitted)	No addition
SE▲†	Schlage "E" Keyway cylinder, (Number 41 Cylinder Only, 0-bitted)	No addition
SG	MicroShield® – an antimicrobial powder coat finish	\$73.00
WBS	Wrought Box Strike	No addition

NOTES

▲ Options not available with standard 50 function lockout cylinder.

† Not available with 60, 63, 64 options.

CPC Clear Powder Coat 32D – 7805 x BHD x RH x 32D x CPC \$67.00
All orders will continue to be handled as a "special" when CPC is ordered.

7800 SERIES BEHAVIORAL HEALTH KNOB TRIM (BHD)



BHD

USA & Canada Prices Effective May 1, 2021

NOTE: Not ADA Compliant.

Function	Finish
Single Cyl	32D
7804 Storeroom or Closet	
7805 Office or Entry	
7837 Classroom	\$2,071.00
7855 Office or Entry	
7806 Storeroom or Service	
7831 Utility	
7836 Closet	\$2,093.00
7856 Office or Inner Entry	
7867 Institutional Privacy	
Single Cyl With Deadbolt	
7824 Room Door	
7825 Dormitory or Exit	
7827 Closet or Storeroom	
7828, 7830 Dummy Trim Deadlock	
7835 Storeroom	\$2,120.00
7843 Apartment Corridor	
7845 Dormitory or Exit	
7847 Front Door or Apartment Corridor	
7851 Storeroom Deadbolt	
7850 Hotel Guest Lock	\$2,159.00
Double Cyl No Deadbolt	
7816 Apartment or Exit or Public Toilet	
7817 Asylum or Institutional	\$2,169.00
7838 Classroom Security Intruder	
Double Cyl With Deadbolt	
7826 Store Door	
7829 Dummy Trim Deadlock	
7839, 7840 Classroom Security Intruder	
7841 Classroom Security	\$2,192.00
7846 Dormitory or Exit	
7848 Store Door	
7852 Institutional	
Non Keyed	
7813 Communication or Exit	\$1,907.00
7815 Passage or Closet	
7865 Privacy Bedroom or Bath (Latch)	\$2,012.00
7866, 7868 Privacy Bedroom or Bath (Deadbolt)	\$2,047.00
7893 Single Dummy Trim	\$861.00
7894 Double Dummy Trim	\$1,726.00
7895 Single Dummy Trim w/Lockbody	\$961.00
7896 Double Dummy Trim w/Lockbody	\$1,818.00
7897 Double Dummy w/Active Trim	\$1,907.00

SP-14 HEALTHCARE HARDWARE

SARGENT®

7800 SERIES (BHD) INSIDE, OUTSIDE TRIM, AND MISCELLANEOUS PARTS

ASSA ABLOY

USA & Canada Prices Effective May 1, 2021

Example: IS-7825 BHD x 32D x RH

Inside trim sets include: Inside knob, inside rose or escutcheon, trim pack (spindles, thru-bolt screws, set screws, inside adaptor plate assembly), trim finish screws. CYLINDERS NOT INCLUDED – Order separately.

Lock Function	Trim	32D
IS-7804 IS-7815 IS-7867		
IS-7805 IS-7837 IS-7895	BHD	\$757.00
IS-7806 IS-7855 IS-7896		
IS-7813 IS-7856 IS-7897		
IS-7816 IS-7838 IS-7846		
IS-7817 IS-7839 IS-7848	BHD	\$764.00
IS-7826 IS-7840 IS-7852		
IS-7829 IS-7841 IS-7892		
IS-7824 IS-7830 IS-7850 IS-7868		
IS-7825 IS-7843 IS-7851	BHD	\$789.00
IS-7827 IS-7845 IS-7865		
IS-7828 IS-7847 IS-7866		
Lock Function	Trim	32D
OS-7804 OS-7829 OS-7841 OS-7855		
OS-7805 OS-7830 OS-7843 OS-7856		
OS-7816 OS-7831 OS-7845 OS-7867		
OS-7817 OS-7835 OS-7846		
OS-7824 OS-7836 OS-7847	BHD	\$815.00
OS-7825 OS-7837 OS-7848		
OS-7826 OS-7838 OS-7850		
OS-7827 OS-7839 OS-7851		
OS-7828 OS-7840 OS-7852		
OS-7815 OS-7894 OS-7896 OS-7897	BHD	\$790.00
OS-7865 OS-7866 OS-7868	BHD	\$818.00

TABLE OF CONTENTS

USA & Canada Prices Effective May 1, 2021

Electrical

Electro-Mechanical Locksets.....	EL-1
Electro-Mechanical Exit Device.....	EL-2
ElectroLynx Retrofit Kits.....	EL-3

Electronic Accessories

Switches/Keypads/Push Buttons.....	EL-4
Wall Switches, Electrical Accessories/ Power Supplies & Battery Backup	EL-5
Monitoring Accessories/Key Switches	EL-6
Electromagnetic Locks	EL-7

Alarms - 5300

Exit Alarms 5300 Series.....	EL-8
------------------------------	------

Fire Guard Door Closers

Electromechanical 351EHT/EHT DCloser-Holder Release Device	EL-9
Fire Guard Closers 2409 Series	EL-9
Fire Guard Closers 2900 Series	EL-10

Parts

01-0997 thru 63-3056.....	EL-11
63-3057 thru 82-3618.....	EL-12

USA & Canada Prices Effective May 1, 2021



10 Line Electrical Options **Price**

RX	Request to exit or enter switch	\$206.00
----	---------------------------------	----------

Function
Key - in - Lever Bored Series

10G70-12V/10G70-24V	Single Cylinder - Fail Safe	Price as listed on page BL-17, 19, 21
10G71-12V/10G71-24V	Single Cylinder - Fail Secure	

Mortise Electrical Lock Option

RX	Request to exit or enter switch	List Price \$206.00	Add
DX	Deadbolt Monitoring	List Price \$197.00	Add
LX	Latchbolt Monitor	List Price \$200.00	Add
TL	SARGuide™ – Illuminated WT Escutcheon	List Price \$232.00	Add

Mortise Lever Series – Specify 12v or 24v

8270-12v / 8270-24v	Single Cylinder - Fail Safe
8271-12v / 8271-24v	Single Cylinder - Fail Secure
8272-12v / 8272-24v	Double Cylinder - Fail Safe
8273-12v / 8273-24v	Double Cylinder - Fail Secure
9270-12v / 9270-24v	Single Cylinder - Fail Safe
9271-12v / 9271-24v	Single Cylinder - Fail Secure
9272-12v / 9272-24v	Double Cylinder - Fail Safe
9273-12v / 9273-24v	Double Cylinder - Fail Secure

Refer to Mortise Lock section for pricing

Electro-Mechanical Locksets are available in all Finishes and Designs as listed on the standard product series price pages referenced above.

ELECTRO-MECHANICAL EXIT DEVICES

ASSA ABLOY

USA & Canada Prices Effective May 1, 2021

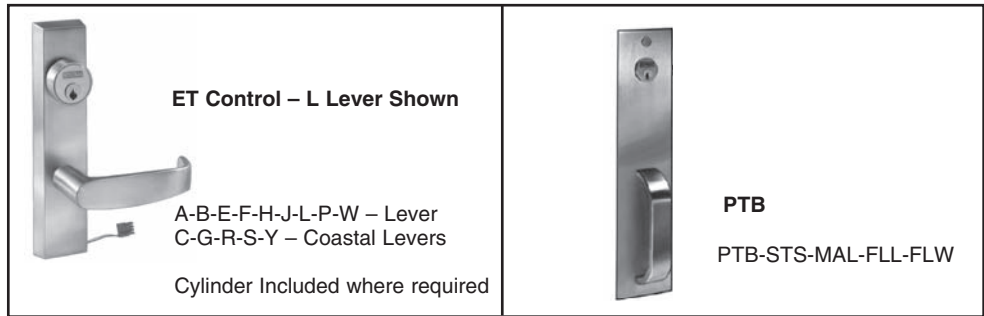

Series	ET Control Lever Designs:	Pull Designs
80 Series = Pushbar Type Exit Device	A, B, E, F, J, L, P, W	PTB, FLL, STS,
90 Series = Crossbar Type Exit Device	C, G, R, S, Y - Coastal Designs	FLW, MAL
8373, 8973	Mortise	Fail Safe
8374, 8974	Mortise	Fail Secure
8375, 8975, 9975	Mortise	Fail Safe
8376, 8976, 9976	Mortise	Fail Secure
AD8473, MD8473	Concealed	Fail Safe
AD8474, MD8474	Vertical Rod	Fail Secure
AD8573	Rim	Fail Safe
AD8574	Rim	Fail Secure
AD8673, MD8673, WD8673, SP8673, PP8673,	Concealed	Fail Safe
PR8673, LS8673, LP8673, LR8673	Vertical Rod	
MD8674, WD8674, SP8674, PP8674,	Concealed	Fail Secure
PR8674, LS8674, LP8674, LR8674	Vertical Rod	
8773, NB8773, SP8773, PP8773, PR8773, 9773	Surface	Fail Safe
8774, NB8774, SP8774, PP8774, PR8774, 9774	Vertical Rod	Fail Secure
FM8773	Concealed	Fail Safe
FM8774	Vertical Rod	Fail Secure
8873	Rim	Fail Safe
8874	Rim	Fail Secure
8875, 9875	Rim	Fail Safe
8876, 9876	Rim	Fail Secure
700 Series ET Lever Trim Only	Function	
773 Control		Fail Safe
774 Control		Fail Secure
775 Control		Fail Safe
776 Control		Fail Secure

Refer to Exit Device section for pricing.

Note: 73 and 74 functions are Non-cylinder functions.
773 and 774 ET trims are Non-cylinder trims.
ET Trim supplied in 26D finish in lieu of 32D.

Electronic Exit Device - refer to ED-4 thru ED-44 for pricing w/Exit Device and restrictions		
Option	Description	Price
53	Latchbolt Monitor Switch	Add \$256.00
54	Internal Micro Switch for ET Control	Add \$232.00
55	Signal Switch in Rail	Add \$241.00
56	Remote Dogging/Latch Retraction	Add \$852.00
57	Delayed Action - order magnet separate	Add \$1,407.00
58	Electric Dogging	Add \$487.00
59	Electroguard (Cylinder provided in rail)	Add \$1,723.00
BC59	Electroguard Boca Code (Cylinder provided in rail)	Add \$1,829.00
AL	Exit Alarm	Add \$595.00
TL	SARGuide™ - Illuminated Touchpad	Add \$232.00
PL	SARGuide™ PL - Photoluminescent Coating	Add \$376.00

USA & Canada Prices Effective May 1, 2021

ElectroLynx - Retrofit Kits		
	How to Order:	Price
Retro 3 R/Way CBL-2Wire	52-2945	\$17.07
Retro TL-3 R/Way CBL-2Wire	52-2979	\$10.10
53- 3 R/Way CBL-3 Wire	52-2980	\$11.91
55- 3 R/Way CBL-3 Wire	52-2981	\$11.91
For Solenoid Only - 3' - QC2A - 2 Pin Connector w/2 wires	52-2982	\$37.01
For Solenoid Only - 15' - QC2A - 2 Pin Connector w/2 wires	52-2983	\$44.06
For TL option (SARGuide) - 3' - QC2A - 2 Pin Connector with 2 wires	52-2984	\$44.06
For 59- Circuit Board & Harness Repl. Kit (F size rail)	52-2994	\$747.42
For 59- Circuit Board & Harness Repl. Kit (J size rail)	52-2995	\$747.42
For 59- Circuit Board & Harness Repl. Kit (G size rail)	52-2996	\$747.42
For 57- Circuit Board & Harness Repl. Kit (F size rail)	52-2997	\$616.98
For 57- Circuit Board & Harness Repl. Kit (J size rail)	52-2998	\$616.98
For 57- Circuit Board & Harness Repl. Kit (G size rail)	52-2999	\$616.98
3 -4P E-Lynx Kit	52-3450	\$14.78
Note: **56- using timer mode (and ED56)		
**TL-56 (and ED56)		
**59- all functions or latch bolt monitor and remote arm delay		
**AL- when using 546 harness door status and remote reset wires		
Terminal Female (AWG20-24)	52-0361	\$0.33
Terminal Female (AWG 26-30)	52-0362	\$0.33
Terminal Male (AWG20-24)	52-0363	\$0.33
Terminal Male (AWG 26-30)	52-0364	\$0.33

Custom Wiring Diagrams Services:		
Catalog#	Description	Price
WD-BASIC	Basic Riser/Elevation Diagrams	****
WD-SPEC	Specification Package	****
WD-P2P	Point to Point	****
WD-SYSPK	System package	****
WD-SWP	Special Wiring Package	****

****Consult the Electromechanical Technical Services Team @ 800-810-WIRE (9473) to establish the price, type & number of wiring diagrams required for your project.

USA & Canada Prices Effective May 1, 2021

855 Signal Switch Kit for 80 & 30 Series Exit Devices		Price
855	Signal Switch Kit	\$376.00
Key Pads and Card Reader		Price
4291	Microprocessor Controller Keypad	\$561.00
4292	Weatherproof Microprocessor Controlled Keypad	\$593.00
4301	Card Reader	\$1,103.00

USA & Canada Prices Effective May 1, 2021

Wall Switches		Price
4397HP	Narrow type switch with handicap logo & push to operate door	\$260.00
4397HPRF	Narrow type switch with handicap logo & push to operate door & RF option	\$370.00
4396HP	6" x 6" Square type wall switch with handicap logo & press to operate door	\$383.00
4396HPRF	6" x 6" Square type wall switch with handicap logo & press to operate door & RF option	\$514.00
4396P	6" x 6" Square type wall switch with press to open	\$375.00
4396PRF	6" x 6" Square type wall switch with press to open & RF option	\$514.00
4395HP	6" Round type wall switch with handicap logo & press to operate door	\$466.00
4395HPRF	6" Round type wall switch with handicap logo & press to operate door & RF option	\$594.00
4395P	6" Round type wall switch with press to open	\$466.00
4395PRF	6" Round type wall switch with press to open & RF option	\$594.00
4341	1" x 3/4" Surface mount push button	\$114.00
4399	2" Square green push button	\$114.00

Electrical Accessories		Price
546	AL-Wiring Harness (For AL- option) - Mfg. prior to 7/1/04	\$73.00
546-F	AL-Wiring Harness (For AL- option Exits F-Size Rail) - Mfg. after 7/1/04	\$73.00
546-G	AL-Wiring Harness (For AL- option Exits G-Size Rail) - Mfg. after 7/1/04	\$73.00
546-J	AL-Wiring Harness (For AL- option Exits J-Size Rail) - Mfg. after 7/1/04	\$73.00
3261	Armored Door Loop	\$73.00
3285	Surface Actuator Switch	\$84.00
3287	Concealed Actuator Switch	\$93.00
52-0171	Magnetic Stripe Card Pack for 4301 Card Reader (25 each minimum)	\$6.00
4352	Junction Box for 4292	\$60.00

* Voice Modules provided with standard message "Emergency Exit Only". Door can be opened in 15 seconds.
For custom message, consult factory.

Power Supplies		Price
3267	9VDC Power Supply 700MA	\$565.00
3520	24VDC Regulated Power Supply 1 amp.	\$383.00
3521	12VDC Regulated Power Supply 1 amp.	\$383.00
3540	24VDC Regulated Power Supply 2 amp.	\$787.00
3541	12VDC Regulated Power Supply 3 amp.	\$787.00
3550	24VDC Regulated Power Supply 4 amp.	\$1,318.00
3551	12VDC Regulated Power Supply 4.5 amp.	\$1,304.00
3570	24VDC Regulated Power Supply 6 amp.	\$1,594.00
3571	12VDC Regulated Power Supply 6 amp.	\$1,333.00

Battery Backup		Price
TMR2	Timer 0-255 minute time delay	\$242.00
TMR9	Timer 0-35 second time delay	\$121.00
737	Battery - 12VDC - 4 amp.	\$89.00
738	Battery - 24VDC - 4 amp.	\$203.00

USA & Canada Prices Effective May 1, 2021

Monitoring Strike		Price
881	Monitor Strike	\$304.00

For Below Keyswitches		
Option	Description	Price
10	SARGENT Signature Key System	Add \$63.00 /cyl.
11	SARGENT XC Key System (not available with 10, 22, SC, SE options)	No addition
1160	SARGENT XC Large Format Interchangeable Plastic Disposable Construction Core	No addition
1163	SARGENT XC Large Format Interchangeable Core Cylinder - Includes masterkeying charges	\$83.00
1164	SARGENT XC Large Format Interchangeable Construction Core Cylinder	\$83.00
21	SARGENT Construction Key System (lost ball) Standard on all new systems	Add \$16.00 /cyl.
22	SARGENT Construction Key System (split key) to be used on pre-established split key systems only	Add \$32.00 /cyl.
60	SARGENT Large Format Interchangeable Plastic Disposable Construction Core	No addition
63	SARGENT Large Format IC Core Cylinder includes master and grandmaster keying charge	Add \$83.00 /cyl.
64	SARGENT Large Format Interchangeable Construction Core Cylinder	\$83.00
F182	SARGENT KESO Security, Patented, Cylinder	Add \$91.00 /cyl.
82	SARGENT KESO Security Cylinder	Add \$91.00 /cyl.

Keyswitch Number		Price
4370	One SPDT maintained contact switch (replaces 4285)	\$466.00
4371	One SPDT momentary contact switch	\$420.00
4372	One DPDT maintained contact switch	\$540.00
4373	One DPDT momentary contact switch	\$490.00
4374	Two SPDT maintained contact switches	\$490.00
4375	Two SPDT momentary contact switches (replaces 4281)	\$445.00
4376	Two DPDT maintained contact switches	\$574.00
4377	Two DPDT momentary contact switches	\$540.00
4378	One SPDT momentary & one SPDT maintained contact switch	\$490.00
4379	One DPDT momentary & one DPDT maintained contact switch	\$574.00
4380H	Single Gang-Horn ONLY	\$261.00
4380HL	Single Gang-Horn with LED's (green & red)	\$311.00

Suffixes for Key Switches		Price
L	2 LED's One-red, One-green	Add \$54.00
H	1 Horn 80dB	Add \$112.00
T	Adjustable Time Delay (5-120 seconds)	Add \$323.00

Notes: H or T suffixes require a double gang box. Examples: 4371LH, 4378LH.
Horn and time delay combination is NOT available in the same keyswitch

ELECTROMAGNETIC LOCKS

USA & Canada Prices Effective May 1, 2021

Electromagnetic Locks			Finish	
			32D	EB/ED/28
1584	Single Door	Push Side	\$918.00	-
1584H	Single Door	Push Side (Includes dress cover)	-	\$964.00
1585	Double Door	Push Side	\$1,837.00	-
1585J	Double Door	Push Side (Includes 18" wide dress cover)	-	\$1,932.00
1586	Single Door	Pull Side	\$1,100.00	\$1,100.00
1587	Double Door	Pull Side	\$2,206.00	\$2,206.00

Accessories			EB/ED/28
Part Number	Description		
15-0078	Single Dress Cover		\$56.00
15-0079	Double Dress Cover		\$104.00
15-2107	Header Extension Bracket		\$104.00
15-2109	1/4" Stop Filler Plate		\$31.00
15-2110	3/8" Stop Filler Plate		\$31.00
15-2111	1/2" Stop Filler Plate		\$31.00
15-2112	5/8" Stop Filler Plate		\$31.00
15-2113	Concrete/Wood Frame Bracket		\$99.00
15-2114	"Z" Bracket with Cover		\$184.00
			32D
15-2116	Double Horizontal Housing		\$946.00
15-2117	Double Vertical Housing		\$946.00
15-2118	Single Horizontal Housing LHR		\$472.00
15-2119	Single Horizontal Housing RHR		\$472.00

EXIT ALARM 5300 SERIES

USA & Canada Prices Effective May 1, 2021

Exit Alarms 5300 Series		
Option	Description	Price
36	6 Lobe security head screws	\$42.00
37	Spanner head screws	\$29.00
91	Remote Power (Requires 3267 Power Supply)	\$42.00
94	Automatic Re-Arm	\$37.00
TB	Notes: Thru bolts not supplied standard. Add per bolt when ordered with device.	\$6.00

Lever and Knob Trim supplied with 5300 series furnished in 26D finish in lieu of 32D.
All Alarmed Exit Hardware is priced with Cylinders where applicable.

5300 Series			
Less Trim		Finish	
Option	Catalog #	EN/EB/ERD	32D/BSP
	5310	\$1,043.00	\$1,381.00
	5304		
	5313	\$1,111.00	\$1,447.00
	5315		
12	5310	\$1,227.00	\$1,565.00
12	5304		
12	5313	\$1,295.00	\$1,631.00
12	5315		



LL



53 K HTB

5300 Series Trim			Finish	
Option	Function	Description	EN/EB/ERD	32D/BSP
28C	(13 Function)	LL, LB, LP		
28K	(04 Function)	LL, LB, LP		\$384.00
28L	(15 Function)	LL, LB, LP		
28D	(10 Function)	LL, LB, LP		
53 K HTB	(04 Function)		\$214.00	
53 E GTB	(10 Function) - Exit Only		\$105.00	
53 D GTB	(10 Function) - Pull			

ELECTROMECHANICAL 351EHT/EHTD FIRE GUARD CLOSERS 2409 SERIES

USA & Canada Prices Effective May 1, 2021

Additional Features			
Option	Description		Price
36	Torx Security Screws		Add \$18.00
DA	Delayed action		\$41.00
MC	Metal Cover		\$19.00
TB	Mortise Nuts when ordered w/Fire Guard		No addition
351EHT/EHTD			Specify Finish when ordering: EB/ED/EN/EP/EAB
Catalog #	Arm	Description	Price
351	EHT	Single Point (Push or Pull)	\$1,196.00
351	EHTD	Handed Single Point (Double Egress)	\$1,295.00
Parts		Description	Price
* 351A	Mounting Plate		\$97.00
* 351D	Drop Bracket		\$97.00
* 351C	Plastic Cover		\$45.00
* 63-0730	Non-handed Metal Cover		\$55.96
* 4TB	Mortise Nuts ordered separate (4 per set)		\$16.00 /Set
2409 Series Single Point Hold Open			
(All units require voltage)			
Stand Alone Units			Finish
Option	Catalog #	Description	EB/ED/EN/EP/EAB
	2469	Pull Side Mounting (Regular Arm) 120VAC, 24VAC/DC	\$1,199.00
	2479	Pull Side Mounting (Double Egress Arm) (RH or LH) 120VAC, 24VAC/DC	\$1,295.00
	2499	Push Side Mounting (Regular Arm) 120VAC, 24VAC/DC	\$1,199.00

FIRE GUARD CLOSERS 2900 SERIES

USA & Canada Prices Effective May 1, 2021

Additional Features			
Option	Description		Price
80	Adjustable By Pass Hold Open Switch – for 2960, 2970, or 2990- (Not available on 9- Units)		\$98.00
2900 Series Multi Point Hold Open			
(All units require handing and voltage)			
Stand Alone Units			Finish
Option	Catalog #	Description	EN/EB/EP/EAB
	2960	Pull Side Mounting (Slide Arm - Rigid) (RH or LH) 120VAC, 24VAC/DC	\$1,601.00
	2970	Pull Side Mounting (Double Egress) (RH or LH) 120VAC, 24VAC/DC	\$1,638.00
	2980	Pull Side Mounting (Slide Arm - Swing Free) (RH or LH) 120VAC, 24VAC/DC	\$1,641.00
Push Side Mounting (Regular Arm) (RH or LH) 120VAC, 24VAC/DC			
	2991	Up to 1" reveals	
	2992	From 1-1/8" - 4" reveals	\$1,571.00
	2993	From 4-1/8" - 7" reveals	
	2994	From 4-1/8" - 7" reveals (OY Arm) (Heavy Duty)	
	2995	From 7-1/8" - 8-5/8" reveals (OYA Arm) (Heavy Duty)	\$1,879.00

*Please specify finish.

USA & Canada Prices Effective May 1, 2021

Part No.	Price
01-0997 Slide Pin Ret. Ring	\$0.78
* 01-1028 Flat Head Mach. Screw 8-32 x 1/4	\$0.85
* 01-1143 Flat Hd Mach. Screw 12-24 x 5/8"	\$0.99
01-1146 Flat Head Screw 8-32x3/8"	\$1.00
01-1190 Mounting Screw	\$1.86
* 01-1206 Pan Head Mach Screw 8-32 x 5/16	\$0.81
01-1463 Adjusting Rod Screw	\$2.17
* 01-2298 Flat Hd Wood Screw 12 x 1"	\$0.81
* 01-2303 Flat Hd Wood Screw 12 x 2 1/4"	\$2.15
01-2306 Flat Head Wood Screw 12 x 3"	\$2.14
* 01-3438 Flat Hd Mach. Screw 12-24 x 1 3/4"	\$1.77
01-3440 Flat Head Mach Screw 12-24 x 2 1/4"	\$1.77
* 01-4400 Flat Head Mach Screw 12-24 x 2 1/2"	\$1.80
* 01-4401 Pan Head Mach Screw 12-24 x 3/4"	\$0.24
01-4411 Pan Head Screw 12-24 x 3/8"	\$0.70
* 01-4412 Flat Head Mach Screw 12-24 x 5/8"	\$0.38
01-4414 Pan Head Screw 12-24 x 3/8"	\$0.35
* 01-4471 Flat Head Self Tapping Screw 4-40 x 1/4"	\$0.23
01-7005 Diode (for 59-)	\$1.76
01-7011 Star Ring Terminal	\$0.81
01-7012 Self Adhesive Bumper	\$1.32
01-9036 3A-AC Fuse (3560)	\$7.77
01-9041 1.5A-AC Fuse (3510)	\$4.45
01-9042 1.8A In Line Fuse (3510)	\$6.51
01-9063 Washer	\$0.17
08-4687 Fail Secure Solenoid Assy.	\$633.26
08-4688 Fail Secure Solenoid Assy.	\$633.26
CB-351 351/2408 1351EHT Closer Body	\$450.00
CB-351DA351/2408 Closer Body w/Delayed Action	\$491.00
32-1093 Connector -2 Wire	\$3.59
32-1144 Emergency Decal (5800)	\$3.48
32-1190 Screw 4-4 Ounce x 1/4"	\$0.89
32-1272 Wire Mesh for 5100/5800 CVR	\$9.09
32-1364 1.5A-AC Fuse	\$9.60
32-7023 Magnet Pack (540/550)	\$30.23
* 32-7033 5800 Cover Assy. w/Circuit Board	\$784.87
* 32-7035 5810 Cover Assembly w/C-Board	\$784.87
32-7043 Battery Snap/Wire Assy.	\$5.80
32-7044 Tamper Switch & Bracket Assy 5100/5800	\$94.98
32-7059 O/S Shutoff Switch Assy.	\$61.80
* 32-7064 Cover Assembly	\$131.05
32-7067 Chassis Assy. (500-01 Series)	\$526.87
32-7070 5100/5800 Circuit Board w/Back Plate Assy	\$366.94
32-7097 Switch	\$41.29
32-7159 Chassis Assy. (5100)	\$389.27
32-7165 Remote Power/Monitor Connector (Alarms)	\$107.55
* 32-7180 5100/5800 CVR/Wire Mesh Assy.	\$214.72
32-7184 Remote Power Connector	\$64.75
32-7185 Remote Monitor Connector	\$21.63
* 32-7228 Misc. Pkg. A (5104/5110)	\$462.48
* 32-7229 Misc. Pkg. B (5104/5110)	\$520.27
* 32-7230 Misc. Pkg. C (5100)	\$75.99
* 32-7231 Misc. Pkg. D (5115)	\$520.27
32-7232 Misc. Pkg. E (5804)	\$363.33
32-7233 Misc. Pkg. F (5804/5813)	\$408.77
32-7234 Misc. Pkg. G (5810)	\$330.36
32-7235 Misc. Pkg. H (5815)	\$412.93
32-7236 Misc. Pkg. I (5800/12-5800)	\$29.74
32-7237 Misc. Pkg. J (12-5804)	\$660.82

*Please specify finish.

Part No.	Price
32-7238 Misc. Pkg. K (12-5804/12-5813)	\$693.68
32-7239 Misc. Pkg. L (12-5810)	\$619.38
32-7240 Misc. Pkg. M (12-5815)	\$693.68
* 351C Plastic Cover	\$45.00
52-0045 Sounder Horn	\$93.43
52-0047 Red LED for Keyswitch	\$20.28
52-0048 Green LED for Keyswitch	\$20.28
52-0049 Single Gang Cover Plate (w/cyl. hole)	\$52.89
52-0050 Single Gang Cover Plate (w/cyl. and LED holes)	\$58.18
52-0051 Dbl. Gang Cover Plate (w/cyl. LED's, horn hole)	\$66.99
52-0052 Dbl. Gang Cover Plate (w/cyl., LED holes)	\$63.45
52-0053 Dbl. Gang Cover Plate (w/cyl. hole)	\$58.18
52-0054 Dbb. Gang Cover Plate (w/cyl. and horn hole)	\$63.45
52-0069 KP I/S Battery Cover	\$15.00
* 52-0091 Keypad Cyl. Cover	\$101.52
52-0136 Lens Cover	\$2.02
52-0328 Transformer (351 EHT/EHTD)	\$102.24
52-2099 SPDT Momentary Switch Assy	\$72.28
52-2102 SPDT Maintained Switch Assy	\$72.28
52-2104 DPDT Momentary Switch Assy	\$96.97
52-2105 DPDT Maintained Switch Assy	\$96.97
52-2204 Latchbolt Mon. Sw./Harness (Rim Device)	\$79.35
52-2217 59-80 CVR Switch Assy.	\$79.35
52-2220 Latchbolt Mon. Sw./Harness (CVR)	\$81.10
52-2290 Battery Backup Board	\$604.65
52-2320 AL-80 Switch Assy.	\$38.77
52-2675 AL Circuit Board (New)	\$236.20
* 60-0529 Washer	\$4.76
* 60-2179 Mortise Nut Pack (2 1/4" Door Thickness)	\$16.04
* 63-0156 OT Channel	\$92.25
63-0228 Circuit Mounting Post	\$3.94
63-0259 Smoke Detector Mtg. Post	\$21.18
63-0290 Switch Guide	\$13.41
63-0374 Wickman Fuse 1/4 Amp	\$13.08
63-0498 Circuit Brd. Screw Spacer	\$1.11
63-0501 Smoke Det. Mtg. Screw	\$0.75
* 63-0502 Flat Head Tapping Screw 12 x 3/8"	\$0.98
63-0509 Circuit Brd. Mtg. Screw	\$1.89
63-0541 Conduit Support	\$31.66
* 63-0665 2900 4 x 12 Pozidriv Screw	\$17.36
63-0704 351 EHT Slide	\$9.27
63-0705 Slide	\$10.58
* 63-0708 End Cap (2408)	\$10.35
* 63-0716 Latch Cover (351 EHT)	\$80.24
63-0723 Conduit Adapter Plug 1/2" (EHT)	\$5.34
63-0727 Circuit Board Insulator(EHT)	\$5.34
63-0728 Hole Plug 1/4"(EHT)	\$2.68
* 63-0730 Optional - Metal Cover (Non-handed)	\$55.96
63-0732 Spacer (Pull) - 2408	\$10.35
63-0733 Track Insert (Push) - 2498	\$3.91
63-0734 Track Insert (Pull) - 2468/2478	\$3.91
* 63-2216 O Foot Assembly	\$45.56
* 63-2217 OZ Foot Assembly	\$56.86
* 63-2218 OZA Foot Assembly	\$56.86
* 63-2607 Main Arm Assembly-12"	\$56.86
63-2868 Output Connector Assy	\$25.45
* 63-2874 Link Extension Assembly (Main Arm 351EHT)	\$130.86
* 63-3056 Dbl. Egress Arm-RH	\$222.91

Experience a safer
and more open world

PARTS

USA & Canada Prices Effective May 1, 2021

Part No.	Price
* 63-3057 Dbl. Egress Arm-LH	\$222.91
63-3226 Tamper Switch & Wire Assy	\$196.16
* 63-3314 OY Arm Assembly-16"	\$436.18
* 63-3315 OYA Arm Assembly-18"	\$436.18
63-3413 Switch and Plug Assembly	\$98.20
63-3424 Mounting Plate (Long-Push)	\$52.44
63-3425 Mounting Plate (Long-Pull)	\$52.44
63-3426 Mounting Plate (Short Push Side)	\$52.44
63-3431 Screw Pack	\$15.49
* 63-3653 2900 Main Arm Assy LH	\$253.97
* 63-3654 2900 Main Arm Assy RH	\$253.97
* 63-3688 2900 Slide Arm Assy Rigid	\$158.81
* 63-3689 2900 Slide Arm Assy	\$349.47
* 63-3699 2900 Roller/End Cap PK	\$50.78
63-3700 2900 Screw Pack	\$25.40
* 63-3717 2900 Cover Assy-Regular	\$534.79
63-3719 2900 Closer Body Assy	\$1,270.80
* 63-3733 2900LH 24VDC CLS/Holder	\$1,617.70
* 63-3734 2900RH 24VDC CLS/Holder	\$1,617.70
63-3787 2900 Hold Open Pack	\$509.55
* 63-4200 EHT Track Assy	\$794.47
63-4201 EHT Latch Assy	\$397.22
63-4202 EHT Circuit Board	\$238.34
* 63-4206 EHT Arm and Roller Assy	\$105.89
63-4211 EHT Parts Pack	\$25.48
63-4212 EHT Standard Screw Pack	\$22.93
63-4215 Circuit Board 120 VAC	\$529.66
63-4216 Circuit Board 24 VAC/DC	\$291.26
* 63-4219 Arm and Roller Assembly	\$92.72
63-4233 Latch Assembly	\$397.22
* 63-4245 2468 24AC/DC Track Assy.	\$865.17
* 63-4246 2468 120VAC Track Assy.	\$865.17
* 63-4247 2498 24AC/DC Track Assy.	\$865.17
* 63-4248 2498 120VAC Track Assy.	\$865.17
68-0658 Switch Mounting Brkt	\$3.93
68-0704 Decal for Delayed Egress	\$60.32
68-2597 Bridge Rect. Pack	\$29.33
68-2759 55- Switch	\$94.01
82-3618 Locking Tail Assy (8272/73)	\$27.80

*Please specify finish.

PROFILE SERIES - STAND ALONE PRODUCTS

How to Order/ANSI Finish & Function Comparison.....PS-1

10-Line Cylindrical Lock - KP, G1, RF Technology

10-Line Stand Alone Products Options.....PS-2

10-Line Keypad, Profile Series, RF Technology.....PS-3

8200 Series Mortise Lock - KP, G1, RF Technology

8200 Stand Alone Products Options.....PS-4

8200 Keypad, Profile Series.....PS-5

8200 Stand Alone Products Options.....PS-6

8200 RF Technology.....PS-7

80 Series - Rim & Mortise Exit Device - KP, G1, RF Technology

8800/8900/ Stand Alone Products Options.....PS-8

8800/8900 Keypad, Profile Series, RF Technology.....PS-9

Accessories.....PS-10

Parts & Accessories.....PS-11

10-Line Parts & Accessories.....PS-12

8200 Series Parts & Accessories

8200 Keypad Trim and Parts.....PS-13

8200 Stand Alone Products Trim/Parts.....PS-14

80 Series Parts & Accessories

80 Series Trim & Trim Kits.....PS-15

80 Series Parts & Accessories.....PS-16

USA & Canada Prices Effective May 1, 2021

How to Order		
Step	Description	Example
Bored		
Quantity	Each	10 Ea.
Option	Consult catalog for options available	10 Ea. 10-
Product Series	10L Profile Series	10 Ea. 10-10
Function	10G77	10 Ea. 10-10G77
Technology/Trim	Consult catalog for available technology and lever designs	10 Ea. 10-G1-10G77 PKL
Finish	Consult catalog for available finishes	10 Ea. 10-G1-10G77 PKL 26D
Mortise		
Quantity	Each	10 Ea.
Option	Consult catalog for options available	10 Ea. 10-
Product Series	8200 Profile Series	10 Ea. 10-82
Function	Consult catalog for available functions	10 Ea. 10-8276
Technology/Trim	Consult catalog for technology and available lever designs	10 Ea. 10-G1-8276 PKL
Finish	Consult catalog for available finishes	10 Ea. 10-G1-8276 PKL 26D
Hand	Specify Hand	10 Ea. 10-G1-8276 PKL 26D RH
Exit		
Quantity	Each	10 Ea.
Option	Consult catalog for options available	10 Ea. 12-
Technology	LU	10 Ea. 12-G1-LU
Product Series	80 Series Profile Series	10 Ea. 12-G1-LU-88
Function	Consult catalog for available functions	10 Ea. 12-G1-LU-8877
Trim - ET	Consult catalog for available lever designs	10 Ea. 12-G1-LU-8877 ETL
Finish (Trim/ET)	Consult catalog for available finishes	10 Ea. 12-G1-LU-8877 ETL 26D/32D
Hand	Specify Hand	10 Ea. 12-G1-LU-8877 ETL 26D/32D RHR
Door Size	Specify Door width	10 Ea. 12-G1-LU-8877 ETL 26D/32D RHR x 36"
Technology Catalog #		
Catalog #	Description	
KP	Keypad - 100 User	
LK	Profile Series - Keypad - 100 Users	
G1-LU	Profile Series - Keypad - 2,000 Users	
G1-PA	Profile Series - Prox only - 2,000 Users	
G1-PK	Profile Series - Prox & Keypad - 2,000 Users	
G1-TU	Profile Series - RF Actuation Keypad - 2,000 Users	
G1-TA	Profile Series - RF Actuation Prox only - 2,000 Users	
G1-TP	Profile Series - RF Actuation Prox & Keypad - 2,000 users	

Function Catalog #	Description
Bored Lock	
10G77	Entry Lock with cylinder override
Mortise Lock	
8276	Entry Lock with cylinder override and deadbolt
8277	Entry Lock with deadbolt (no cylinder)
8278	Entry Lock with cylinder override (no deadbolt)
8279	Entry Lock (no cylinder or deadbolt)
82243	Dorm Room Anti-Lock w/deadbolt & 1/5 Lever Switch
80 Series Exit - Rim	
8877	with cylinder override
8878	without cylinder override
80 Series Exit - Mortise	
8977	with cylinder override
8978	without cylinder override

Finish SARGENT	Description	ANSI
US3	Polished brass	605
US4	Satin brass	606
US9	Polished bronze	611
US10	Satin bronze, clear powder coat	612
US10B	Oxidized satin bronze oil rubbed	613
US10BL	Oxidized satin bronze, clear powder coat	—
US14	Bright nickel, clear coated	618
US15	Satin nickel, clear coated	619
US20D	Dark statuary bronze, clear powder coat	—
US26	Polished chrome	625
US26D	Satin chrome	626
US32	Polished stainless steel	629
US32D	Satin stainless steel	630
BSP	Black Suede Powder Coat	—
WSP	White Suede Powder Coat	—

Note: Refer to each price page for available finishes by product series.

PS-2 PROFILE SERIES

SARGENT®

10-LINE STAND ALONE PRODUCTS

ASSA ABLOY

USA & Canada Prices Effective May 1, 2021

Options	Description	Price
10	SARGENT Signature Key System	\$63.00 /cyl
11	SARGENT XC Key System (not available with 10, 22, SC, SE)	No addition
1160	SARGENT XC Large Format Interchangeable Plastic Disposable Construction Core	No addition
1163	SARGENT XC Large Format Interchangeable Core Cylinder - Includes masterkeying charges	\$83.00
1164	SARGENT XC Large Format Interchangeable Construction Core Cylinder	\$83.00
1170	Small Format interchangeable disposable construction core - to accept 7 Pin XC permanent core	No Add
11727P	Small Format interchangeable keyed construction core - to accept 7 Pin XC permanent core	\$75.00
11737P	Small Format interchangeable core - to accept 7 pin XC permanent core	\$75.00 / cyl.
21	SARGENT Construction Key System (lost ball) - for new systems est. since 5/1/96	\$16.00 /cyl
22	SARGENT Construction Key System (split key) - for pre-est. split key systems only	\$32.00 /cyl
23	Lockset x 3 3/4" Backset	\$10.00
25	Lockset x 5" Backset	\$15.00
28	Lockset x ANSI A115.2-1971 Strike #808: - Lip lengths 1-1/8", 1-1/4" or 1-3/8" - Lip Lengths 1-5/8" to 2-7/8" in 1/4" increments	No addition \$11.00
30	10 Line Lever to accept Schlage cylinder (no cylinder provided)	No addition
36	6 Lobe head security screws	\$15.00
37	Spanner head security screws	\$10.00
41	3/4" throw with latch	\$106.00
60	SARGENT Large Format Interchangeable Plastic Disposable Construction Core	No addition
63	SARGENT Large Format Interchangeable Core Cylinder includes master and grandmaster keying charge	\$83.00
64	SARGENT Large Format Interchangeable Construction Core Cylinder	\$83.00
6573	Small Format 6-Pin Uncombined Core (Refer to CK-12) Not available with J lever	\$65.00
65737P	Small Format 7-Pin Uncombined Core (Refer to CK-12) Not available with J lever	\$65.00
70	Small Format Interchangeable disposable plastic construction core (not avail. w/J Lever)	No addition
72	Small Format Interchangeable 6-Pin construction core (not avail. w/J Lever)(7-Pin with 11 option)	\$75.00
73	Small Format Interchangeable 6-Pin core (not avail. w/J Lever)	\$75.00 /cyl.
737P	Small Format Interchangeable 7-Pin core (not avail. w/J Lever)	\$75.00 /cyl.
75	Tactile Warning - Milled on backside of inside lever (Not available with Coastal Levers)	\$40.00
76	Tactile Warning - Milled on backside of outside lever (Not available with Coastal Levers)	\$40.00
77	Tactile Warning - Milled on backside of both levers (Not available with Coastal Levers)	\$80.00
80	Levers to accept KESO and KESO F1 - no cylinder provided (not avail. w/J Lever)	-\$94.00/cyl.
82	SARGENT KESO Security Cylinder (not avail. w/J Lever) (for existing systems)	\$91.00 /cyl
F182	SARGENT KESO Security Cylinder - Patented - (not avail. w/J Lever)	\$91.00 /cyl
85	Tactile Warning - Abrasive coating on inside lever	\$49.00
86	Tactile Warning - Abrasive coating on outside lever	\$49.00
87	Tactile Warning - Abrasive coating on both levers	\$98.00
91	Remote Power/Unlocking - requires 3267 Power Supply	\$42.00
BR	SARGENT Bump Resistant Cylinders (N/A w/10, 22, 30, 60, 63, 64, 70, 72, 73, 737P, KESO, SC, SE)	Add \$25.00 /cyl.
DG1	Patented Degree DG1 Key System	No addition
DG160	Hardware prepared for DG1-6300 Lg. Format IC cores, supplied with temporary plastic construction cores	No addition
DG163	Patented Degree DG1 Large Format Interchangeable Core Cylinder - Includes master keying charges	\$83.00
DG164	Hardware prepared for DG1-6300 Lg. Format IC cores, supplied with temporary keyed construction cores	\$83.00
DG2	Patented Degree DG2 Key System incorporating a locking sidebar	\$63.00/cyl.
DG260	Hardware prepared for DG2-6300 Lg. Format IC cores, supplied with temporary plastic construction cores	No addition
DG263	Patented Degree DG2 Large Format Interchangeable Core Cylinder - Includes master keying charges	\$146.00
DG264	Hardware prepared for DG2-6300 Lg. Format IC cores, supplied with temporary keyed construction cores	\$83.00
DG3	Patented Degree DG3 Key System incorporating a locking sidebar and UL437 listed	\$89.00/cyl.
DG360	Hardware prepared for DG3-6300 Lg. Format IC cores, supplied with temporary plastic construction cores	No addition
DG363	Patented Degree DG3 Large Format Interchangeable Core Cylinder - Includes master keying charges	\$172.00
DG364	Hardware prepared for DG3-6300 Lg. Format IC cores, supplied with temporary keyed construction cores	\$83.00
DM	Forced/propped door harness (not available on 82243)	Add \$12.00
LC	Less Cylinder	-\$94.00/cyl.
SC	Schlage C Keyway cylinder, 0-bitted	No addition
SE	Schlage E Keyway cylinder, 0-bitted	No addition
SF	L Lever to accept Schlage Large Format Interchangeable Core (supplied less core, tailpiece included)	No Addition
SG	MicroShield® an antimicrobial powder coat finish	\$73.00
WBS	Wrought Box Strike	No Addition

Experience a safer
and more open world

Copyright © 2002-2021 Sargent Manufacturing Company, an ASSA ABLOY Group company. All rights reserved.
Reproduction in whole or in part without the express written permission of Sargent Manufacturing Company is prohibited.
Contact us at: 800-727-5477 or visit www.sargentlock.com. In Canada contact us at: 800-461-3007 or visit www.assaabloydss.ca



10L-Keypad

Rose Designs: L & G

Standard Lever Designs: B, J, L, P

Coastal Lever Designs: Y & G

Function			10BE/26D/ BSP/WSP	03/04/09/10/10B 10BL/14/15/20D/26
Option	Function	Single Cylinder		
KP	10G77	Storeroom x Rose x Lever Design (100 users)	\$1,173.00	\$1,278.00



10L-Profile Series

Standard Lever Designs: B, J, L, P

Coastal Lever Designs: Y & G

10L Profile Series				10BE/26D/ BSP/WSP	03/04/09/10/10B 10BL/14/15/20D/26
Option	Function	Trim	Description		
	10G77	LK x Lever Design	Keypad Entry Lock with Cylinder Override (100 Users)	\$1,320.00	\$1,425.00
G1	10G77	LU x Lever Design	Keypad Entry Lock with Cylinder Override (2,000 Users)	\$1,514.00	\$1,619.00
G1	10G77	PA x Lever Design	*Proximity Only Entry Lock with Cylinder Override (2,000 Users)	\$2,051.00	\$2,156.00
G1	10G77	PK x Lever Design	Proximity and Keypad Entry Lock with Cylinder Override (2,000 Users)	\$2,132.00	\$2,237.00

*Requires SoloPlus for programming.

10L Profile Series with RF Technology				10BE/26D/ BSP/WSP	03/04/09/10/10B 10BL/14/15/20D/26
Option	Function	Trim	Description		
G1	10G77	TU x Lever Design	RF Actuation Keypad Entry Lock with Cylinder Override (2,000 users)	\$1,780.00	\$1,885.00
G1	10G77	TA x Lever Design	*RF Actuation Prox Only Entry Lock with Cylinder Override (2,000 users)	\$2,317.00	\$2,422.00
G1	10G77	TP x Lever Design	RF Actuation Proximity & Keypad Entry Lock with Cylinder Override (2,000 users)	\$2,399.00	\$2,504.00

Note: RF FOB must be ordered separate from locks – See page PS-10.

*Requires SoloPlus for programming.

PS-4 PROFILE SERIES

SARGENT®

8200 STAND ALONE PRODUCTS

ASSA ABLOY

USA & Canada Prices Effective May 1, 2021

Options	Description	Price
3	Stainless Steel Hubs	\$69.00
10	Sargent Signature System meeting UL437	\$63.00 /cyl
11	SARGENT XC Key System (not available with 10, 22, SC, SE)	No addition
1160	SARGENT XC Large Format Interchangeable Plastic Disposable Construction Core	No addition
1163	SARGENT XC Large Format Interchangeable Core Cylinder - Includes masterkeying charges	\$83.00
1164	SARGENT XC Large Format Interchangeable Construction Core Cylinder	\$83.00
1170	Small Format interchangeable disposable construction core - to accept 7 Pin XC permanent core	No Add
11727P	Small Format interchangeable keyed construction core - to accept 7 Pin XC permanent core	\$75.00
11737P	Small Format interchangeable core - to accept 7 pin XC permanent core	\$75.00 / cyl.
21	SARGENT Construction Key System (lost ball) - for new systems est. since 5/1/96	\$16.00 /cyl
22	SARGENT Construction Key System (split key) - for pre-est. split key systems only	\$32.00 /cyl
23	4-7/8" ANSI Strike	No addition
36	6 Lobe head security screws	\$24.00
37	Spanner head security screws	\$17.00
60	SARGENT Large Format Interchangeable Plastic Disposable Construction Core	No addition
63	SARGENT Large Format Interchangeable Core Cylinder includes master and grandmaster keying charge	\$83.00
64	SARGENT Large Format Interchangeable Construction Core Cylinder	\$83.00
6573	Small Format 6-Pin Uncombined core (Refer to CK-12) Not available with J Lever	\$65.00 /cyl.
65737P	Small Format 7-Pin uncombined core (Refer to CK-12) Not available with J Lever	\$65.00 /cyl.
70	Small Format Interchangeable disposable plastic construction core	No addition
72	Small Format Interchangeable 6-Pin construction core (7-Pin with 11 option)	\$75.00
73	Small Format Interchangeable 6-Pin core	\$75.00 /cyl.
737P	Small Format Interchangeable 7-Pin core	\$75.00 /cyl.
75	Tactile Warning - Milled on backside of inside lever (Not available with Studio & Coastal Levers and the A Lever)	\$78.00
76	Tactile Warning - Milled on backside of outside lever (Not available with Studio & Coastal Levers and the A Lever)	\$78.00
77	Tactile Warning - Milled on backside of both levers (Not available with Studio & Coastal Levers and the A Lever)	\$156.00
81	Cylinder to accept KESO & KESO F1 removable core - no core provided	No addition
82	SARGENT KESO Security Cylinder (for existing systems)	\$91.00 /cyl
F182	SARGENT KESO Security Cylinder - Patented	\$91.00 /cyl
83	SARGENT KESO Security Removable core cylinder (for existing systems)	\$130.00 /cyl
F183	SARGENT KESO Security Removable core cylinder - Patented	\$130.00 /cyl
84	SARGENT KESO Security removable construction core cylinder	See CK-18
85	Tactile Warning - Abrasive coating on inside lever	\$49.00
86	Tactile Warning - Abrasive coating on outside lever	\$49.00
87	Tactile Warning - Abrasive coating on both levers	\$98.00
91	Remote Power/Unlocking - requires 3267 Power Supply	\$42.00
BR	SARGENT Bump Resistant Cylinders (N/A w/10, 22, 30, 60, 63, 64, 70, 72, 73, 737P, KESO, SC, SE)	Add \$25.00 /cyl.
DG1	Patented Degree DG1 Key System	No addition
DG160	Hardware prepared for DG1-6300 Lg. Format IC cores, supplied with temporary plastic construction cores	No addition
DG163	Patented Degree DG1 Large Format Interchangeable Core Cylinder - Includes master keying charges	\$83.00
DG164	Hardware prepared for DG1-6300 Lg. Format IC cores, supplied with temporary keyed construction cores	\$83.00
DG2	Patented Degree DG2 Key System incorporating a locking sidebar	\$63.00/cyl.
DG260	Hardware prepared for DG2-6300 Lg. Format IC cores, supplied with temporary plastic construction cores	No addition
DG263	Patented Degree DG2 Large Format Interchangeable Core Cylinder - Includes master keying charges	\$146.00
DG264	Hardware prepared for DG2-6300 Lg. Format IC cores, supplied with temporary keyed construction cores	\$83.00
DG3	Patented Degree DG3 Key System incorporating a locking sidebar and UL437 listed	\$89.00/cyl.
DG360	Hardware prepared for DG3-6300 Lg. Format IC cores, supplied with temporary plastic construction cores	No addition
DG363	Patented Degree DG3 Large Format Interchangeable Core Cylinder - Includes master keying charges	\$172.00
DG364	Hardware prepared for DG3-6300 Lg. Format IC cores, supplied with temporary keyed construction cores	\$83.00
DM	Forced/propped door harness (not available on 82243)	Add \$12.00
LC	Less Cylinder	-\$96.00/cyl.
SC	Schlage C keyway cylinder "0" bitted (not available with Profile Series)	No addition
SE	Schlage E keyway cylinder "0" bitted (not available with Profile Series)	No addition
SG	MicroShield® - an antimicrobial powder coat	\$73.00
WBS	Wrought Box Strike	No Addition

Experience a safer
and more open world

Copyright © 2002-2021 Sargent Manufacturing Company, an ASSA ABLOY Group company. All rights reserved.
Reproduction in whole or in part without the express written permission of Sargent Manufacturing Company is prohibited.
Contact us at: 800-727-5477 or visit www.sargentlock.com. In Canada contact us at: 800-461-3007 or visit www.assaabloydss.ca

ASSA ABLOY

8200 STAND ALONE PRODUCTS

USA & Canada Prices Effective May 1, 2021



8200 KEYPAD

Standard Rose Designs: LN, L
Standard Lever Designs: A, B, E, F, J, L, P, W

Coastal Rose Designs: CR, TR
Coastal Lever Designs: G, R, S, Y

Studio Rose Designs: E2, E3, E4, CO, TO, CR, TR, LN, O
Studio Collection Levers Except for Gramercy, Wooster Square, & Grant Park

For Gramercy, Wooster Square, & Grant Park Levers – Add \$138.00 to below prices
Consult catalog for available lever designs, finishes, & ordering information.

Option	Function	Description	10BE/26D/ BSP/WSP	03/04/09/10/10B/ 10BL/14/15/20D/26
KP	8276	Keypad Entry lock with cylinder override	\$1,277.00	\$1,435.00
KP	8277	Keypad Entry lock - no cylinder available	\$1,203.00	\$1,361.00
KP	8278	Keypad Entry lock with cylinder override, no deadbolt	\$1,255.00	\$1,413.00
KP	8279	Keypad Entry lock - no cylinder override and no deadbolt	\$1,178.00	\$1,336.00



8200 PROFILE SERIES

Standard Lever Designs: A, B, E, F, J, L, P, W

Coastal Lever Designs: G, R, S, Y

Studio Collection Levers Except for Gramercy, Wooster Square, & Grant Park

For Gramercy, Wooster Square, & Grant Park Levers – Add \$138.00 to below prices
Consult catalog for available lever designs, finishes, & ordering information.

8200 Profile Series			10BE/26D/ BSP/WSP	03/04/09/10/10B/ 10BL/14/15/20D/26
Option/Function/Trim	Description			
G1 82243 PA x Lever Design	*Proximity ONLY Dorm Room Anti-lock w/D.bolt and I/S Lever Switch (2,000 Users)		\$2,452.00	\$2,610.00
G1 82243 PK x Lever Design	Proximity Keypad Dorm Room Anti-lock w/D.bolt and I/S Lever Switch (2,000 Users)		\$2,527.00	\$2,685.00
8276 LK x Lever Design	Keypad Entry Lock w/Cylinder Override, w/Deadbolt (100 Users)		\$1,385.00	\$1,543.00
G1 8276 LU x Lever Design	Keypad Entry Lock w/Cylinder Override, w/Deadbolt (2,000 Users)		\$1,576.00	\$1,734.00
G1 8276 PA x Lever Design	*Proximity ONLY Entry Lock w/Cylinder Override, w/Deadbolt (2,000 Users)		\$2,111.00	\$2,269.00
G1 8276 PK x Lever Design	Proximity and Keypad Entry Lock w/Cyl. Override, w/Deadbolt (2,000 Users)		\$2,188.00	\$2,346.00
8277 LK x Lever Design	Keypad Entry Lock w/o Cylinder Override, w/Deadbolt (100 Users)		\$1,321.00	\$1,479.00
G1 8277 LU x Lever Design	Keypad Entry Lock w/o Cylinder Override, w/Deadbolt (2,000 Users)		\$1,515.00	\$1,673.00
G1 8277 PA x Lever Design	*Proximity ONLY Entry Lock w/o Cylinder Override, w/Deadbolt (2,000 Users)		\$2,044.00	\$2,202.00
G1 8277 PK x Lever Design	Proximity and Keypad Entry Lock w/o Cyl. Override, w/Deadbolt (2,000 Users)		\$2,123.00	\$2,281.00
8278 LK x Lever Design	Keypad Entry Lock w/Cylinder Override, w/o Deadbolt (100 Users)		\$1,367.00	\$1,525.00
G1 8278 LU x Lever Design	Keypad Entry Lock w/Cylinder Override, w/o Deadbolt (2,000 Users)		\$1,559.00	\$1,717.00
G1 8278 PA x Lever Design	*Proximity ONLY Entry Lock w/Cylinder Override, w/o Deadbolt (2,000 Users)		\$2,087.00	\$2,245.00
G1 8278 PK x Lever Design	Proximity and Keypad Entry Lock w/Cyl. Override, w/o Deadbolt (2,000 Users)		\$2,170.00	\$2,328.00
8279 LK x Lever Design	Keypad Entry Lock w/o Cylinder Override, w/o Deadbolt (100 Users)		\$1,302.00	\$1,460.00
G1 8279 LU x Lever Design	Keypad Entry Lock w/o Cylinder Override, w/o Deadbolt (2,000 Users)		\$1,493.00	\$1,651.00
G1 8279 PA x Lever Design	*Proximity ONLY Entry Lock w/o Cylinder Override, w/o Deadbolt (2,000 Users)		\$2,025.00	\$2,183.00
G1 8279 PK x Lever Design	Proximity and Keypad Entry Lock w/o Cyl. Override, w/o Deadbolt (2,000 Users)		\$2,108.00	\$2,266.00

Note: RF FOB must be ordered separate from locks – See page PS-10.

*Requires SoloPlus for programming.

PS-6 PROFILE SERIES

SARGENT®

8200 STAND ALONE PRODUCTS

ASSA ABLOY

USA & Canada Prices Effective May 1, 2021

Options	Description	Price
3	Stainless Steel Hubs	\$69.00
10	SARGENT Signature Key System	\$63.00 /cyl
11	SARGENT XC Key System (not available with 10, 22, SC, SE)	No addition
1160	Sargent XC Large Format Interchangeable Plastic Disposable Construction Core	No addition
1163	Sargent XC Large Format Interchangeable Core Cylinder - Includes masterkeying charges	\$83.00
1164	Sargent XC Large Format Interchangeable Construction Core Cylinder	\$83.00
1170	Small Format interchangeable disposable construction core - to accept 7 Pin XC permanent core	No Add
11727P	Small Format interchangeable keyed construction core - to accept 7 Pin XC permanent core	\$75.00
11737P	Small Format interchangeable core - to accept 7 pin XC permanent core	\$75.00 / cyl.
21	SARGENT Construction Key System (lost ball) - for new systems est. since 5/1/96	\$16.00 /cyl
22	SARGENT Construction Key System (split key) - for pre-est. split key systems only	\$32.00 /cyl
23	4-7/8" ANSI Strike	No addition
36	6 Lobe head security screws	\$24.00
37	Spanner head security screws	\$17.00
60	SARGENT Large Format Interchangeable Plastic Disposable Construction Core	No addition
63	SARGENT Large Format Interchangeable Core Cylinder includes master and grandmaster keying charge	\$83.00
64	SARGENT Large Format Interchangeable Construction Core Cylinder	\$83.00
6573	Small Format 6-Pin Uncombined Core (Refer to CK-12) Not available with J lever	\$65.00
65737P	Small Format 7-Pin Uncombined Core (Refer to CK-12) Not available with J lever	\$65.00
70	Small Format interchangeable disposable plastic construction core (Not available with J lever)	No addition
72	Small Format interchangeable 6-Pin construction core (not available with J lever)	\$75.00
73	Small Format interchangeable core 6-pin Includes MK and GMK keying charges (Not available with J lever)	\$75.00
737P	Small Format interchangeable core 7-pin (refer to CK-12 for available keyways) Includes MK and GMK keying charges (Not available with J lever)	\$75.00
75	Tactile Warning - Milled on backside of inside lever (Not available with Studio & Coastal Levers and the A Lever)	\$78.00
76	Tactile Warning - Milled on backside of outside lever (Not available with Studio & Coastal Levers and the A Lever)	\$78.00
77	Tactile Warning - Milled on backside of both levers (Not available with Studio & Coastal Levers and the A Lever)	\$156.00
81	Cylinder to accept KESO & KESO F1 removable core - no core provided	No addition
82	SARGENT KESO Security Cylinder (for existing systems)	\$91.00 /cyl
F182	SARGENT KESO Security Cylinder - Patented	\$91.00 /cyl
83	SARGENT KESO Security Removable core cylinder (for existing systems)	\$130.00 /cyl
F183	SARGENT KESO Security Removable core cylinder - Patented	\$130.00 /cyl
84	SARGENT KESO Security removable construction core cylinder	See CK-18
85	Tactile Warning - Abrasive coating on inside lever	\$49.00
86	Tactile Warning - Abrasive coating on outside lever	\$49.00
87	Tactile Warning - Abrasive coating on both levers	\$98.00
91	Remote Power/Unlocking - requires 3267 Power Supply	\$42.00
BR	SARGENT Bump Resistant Cylinders (N/A w/10, 22, 30, 60, 63, 64, 70, 72, 73, 737P, KESO, SC, SE)	Add \$25.00 /cyl.
DG1	Patented Degree DG1 Key System	No addition
DG160	Hardware prepared for DG1-6300 Lg. Format IC cores, supplied with temporary plastic construction cores	No addition
DG163	Patented Degree DG1 Large Format Interchangeable Core Cylinder - Includes master keying charges	\$83.00
DG164	Hardware prepared for DG1-6300 Lg. Format IC cores, supplied with temporary keyed construction cores	\$83.00
DG2	Patented Degree DG2 Key System incorporating a locking sidebar	\$63.00/cyl.
DG260	Hardware prepared for DG2-6300 Lg. Format IC cores, supplied with temporary plastic construction cores	No addition
DG263	Patented Degree DG2 Large Format Interchangeable Core Cylinder - Includes master keying charges	\$146.00
DG264	Hardware prepared for DG2-6300 Lg. Format IC cores, supplied with temporary keyed construction cores	\$83.00
DG3	Patented Degree DG3 Key System incorporating a locking sidebar and UL437 listed	\$89.00/cyl.
DG360	Hardware prepared for DG3-6300 Lg. Format IC cores, supplied with temporary plastic construction cores	No addition
DG363	Patented Degree DG3 Large Format Interchangeable Core Cylinder - Includes master keying charges	\$172.00
DG364	Hardware prepared for DG3-6300 Lg. Format IC cores, supplied with temporary keyed construction cores	\$83.00
DM	Forced/propped door harness (not available on 82243)	Add \$12.00
LC	Less Cylinder	-\$96.00/cyl.
SC	Schlage C Keyway cylinder, 0-bitted	No addition
SE	Schlage E Keyway cylinder, 0-bitted	No addition
SG	MicroShield® an antimicrobial powder coat finish	\$73.00

Experience a safer
and more open world

Copyright © 2002-2021 Sargent Manufacturing Company, an ASSA ABLOY Group company. All rights reserved.
Reproduction in whole or in part without the express written permission of Sargent Manufacturing Company is prohibited.
Contact us at: 800-727-5477 or visit www.sargentlock.com. In Canada contact us at: 800-461-3007 or visit www.assaabloydss.ca

USA & Canada Prices Effective May 1, 2021



8200 PROFILE SERIES

Standard Lever Designs: A, B, E, F, J, L, P, W

Coastal Lever Designs: G, R, S, Y

Studio Collection Levers Except for Gramercy, Wooster Square, & Grant Park

For Gramercy, Wooster Square, & Grant Park Levers – Add \$138.00 to below prices
Consult catalog for available lever designs, finishes, & ordering information.

8200 Profile Series with RF Technology			10BE/26D/ BSP/WSP	03/04/09/10/10B 10BL/14/15/20D/26
Option/Function/Trim	Description			
G1 8276 TU x Lever Design	RF Actuation Keypad Entry Lock w/Cylinder Override, w/D.bolt (2,000 Users)		\$1,843.00	\$2,001.00
G1 8276 TA x Lever Design	*RF Actuation Proximity Entry Lock w/Cylinder Override w/D.bolt (2,000 users)		\$2,372.00	\$2,530.00
G1 8276 TP x Lever Design	RF Actuation Proximity & Keypad Entry Lock w/Cylinder Override, w/Deadbolt (2,000 Users)		\$2,455.00	\$2,613.00
G1 8277 TU x Lever Design	RF Actuation Keypad Entry Lock w/o Cylinder Override, w/Deadbolt (2,000 Users)		\$1,778.00	\$1,936.00
G1 8277 TA x Lever Design	*RF Actuation Proximity Entry Lock w/o Cylinder Override w/D.bolt (2,000 users)		\$2,310.00	\$2,468.00
G1 8277 TP x Lever Design	RF Actuation Proximity & Keypad Entry Lock w/o Cylinder Override, w/Deadbolt (2,000 Users)		\$2,389.00	\$2,547.00
G1 8278 TU x Lever Design	RF Actuation Keypad Entry Lock w/Cylinder Override, w/o Deadbolt (2,000 Users)		\$1,821.00	\$1,979.00
G1 8278 TA x Lever Design	*RF Actuation Proximity Entry Lock w/Cylinder Override w/o D.bolt (2,000 users)		\$2,352.00	\$2,510.00
G1 8278 TP x Lever Design	RF Actuation Proximity & Keypad Entry Lock w/Cylinder Override, w/o Deadbolt (2,000 Users)		\$2,435.00	\$2,593.00
G1 8279 TU x Lever Design	RF Actuation Keypad Entry Lock w/o Cylinder Override, w/o Deadbolt (2,000 Users)		\$1,759.00	\$1,917.00
G1 8279 TA x Lever Design	*RF Actuation Proximity Entry Lock w/o Cylinder Override w/o D.bolt (2,000 users)		\$2,288.00	\$2,446.00
G1 8279 TP x Lever Design	RF Actuation Proximity & Keypad Entry Lock w/o Cylinder Override, w/o Deadbolt (2,000 Users)		\$2,370.00	\$2,528.00

Note: RF FOB must be ordered separate from locks – See page PS-10.

*Requires SoloPlus for programming.

PS-8 PROFILE SERIES

SARGENT®

8800/8900 STAND ALONE PRODUCTS

ASSA ABLOY

USA & Canada Prices Effective May 1, 2021

Options	Description	Price
10	SARGENT Signature Key System	\$63.00 /cyl
11	SARGENT XC Key System (not available with 10, 22, SC, SE)	No addition
1160	Sargent XC Large Format Interchangeable Plastic Disposable Construction Core	No addition
1163	Sargent XC Large Format Interchangeable Core Cylinder - Includes masterkeying charges	\$83.00
1164	Sargent XC Large Format Interchangeable Construction Core Cylinder	\$83.00
1170	Small Format interchangeable disposable construction core - to accept 7 Pin XC permanent core	No Add
11727P	Small Format interchangeable keyed construction core - to accept 7 Pin XC permanent core	\$75.00
11737P	Small Format interchangeable core - to accept 7 pin XC permanent core	\$75.00 / cyl.
12	UL Fire Label Exit Device	\$184.00
16	Cylinder Lockdown feature in rail	\$133.00
19	80 Series pushbar without Lexan Touchpad	No addition
21	SARGENT Construction Key System (lost ball) - for new systems est. since 5/1/96	\$16.00 /cyl
22	SARGENT Construction Key System (split key) - for pre-est. split key systems only	\$32.00 /cyl
23	4-7/8" ANSI Strike	No Add
36	6 Lobe head security screws (8800)	\$52.00
36	6 Lobe head security screws (8900)	\$56.00
37	Spanner head security screws (8800)	\$33.00
37	Spanner head security screws (8900)	\$36.00
60	SARGENT Large Format Interchangeable Plastic Disposable Construction Core	No addition
63	SARGENT Large Format Interchangeable Core Cylinder includes master and grandmaster keying charge	\$83.00
64	SARGENT Large Format Interchangeable Construction Core Cylinder	\$83.00
6573	Small Format 6-Pin Uncombined Core (Refer to CK-12) Not available with J lever	\$65.00
65737P	Small Format 7-Pin Uncombined Core (Refer to CK-12) Not available with J lever	\$65.00
70	Small Format Interchangeable disposable plastic construction core	No addition
72	Small Format Interchangeable 6-Pin construction core (7-Pin with 11 option)	\$75.00
73	Small Format Interchangeable 6-Pin core	\$75.00 /cyl.
737P	Small Format Interchangeable 7-Pin core	\$75.00 /cyl.
76	Tactile Warning - Milled on backside of outside lever (Not available with Studio & Coastal Levers and the A Lever)	\$77.00
81	Cylinder to accept KESO & KESO F1 removable core - no core provided	No addition
82	SARGENT KESO Security Cylinder (for existing systems)	\$91.00 /cyl
F182	SARGENT KESO Security Cylinder - Patented	\$91.00 /cyl
83	SARGENT KESO Security Removable core cylinder (for existing systems)	\$130.00 /cyl
F183	SARGENT KESO Security Removable core cylinder - Patented	\$130.00 /cyl
84	SARGENT KESO Security removable construction core cylinder	See CK-18
85	Tactile Warning - Abrasive strip on push rail	\$101.00
86	Tactile Warning - Abrasive coating on outside lever	\$47.00
87	Tactile Warning - Abrasive strip on push rail & abrasive coating on outside lever	\$148.00
91	Remote Power/Unlocking - requires 3267 Power Supply	\$42.00
BR	SARGENT Bump Resistant Cylinders (N/A w/10, 22, 30, 60, 63, 64, 70, 72, 73, 737P, KESO, SC, SE)	Add \$25.00 /cyl.
DG1	Patented Degree DG1 Key System	No addition
DG160	Hardware prepared for DG1-6300 Lg. Format IC cores, supplied with temporary plastic construction cores	No addition
DG163	Patented Degree DG1 Large Format Interchangeable Core Cylinder - Includes master keying charges	\$83.00
DG164	Hardware prepared for DG1-6300 Lg. Format IC cores, supplied with temporary keyed construction cores	\$83.00
DG2	Patented Degree DG2 Key System incorporating a locking sidebar	\$63.00/cyl.
DG260	Hardware prepared for DG2-6300 Lg. Format IC cores, supplied with temporary plastic construction cores	No addition
DG263	Patented Degree DG2 Large Format Interchangeable Core Cylinder - Includes master keying charges	\$146.00
DG264	Hardware prepared for DG2-6300 Lg. Format IC cores, supplied with temporary keyed construction cores	\$83.00
DG3	Patented Degree DG3 Key System incorporating a locking sidebar and UL437 listed	\$89.00/cyl.
DG360	Hardware prepared for DG3-6300 Lg. Format IC cores, supplied with temporary plastic construction cores	No addition
DG363	Patented Degree DG3 Large Format Interchangeable Core Cylinder - Includes master keying charges	\$172.00
DG364	Hardware prepared for DG3-6300 Lg. Format IC cores, supplied with temporary keyed construction cores	\$83.00
DM	Forced/propped door harness (not available on 82243)	Add \$12.00
LC	Less Cylinder	-\$96.00/cyl.
SC	Schlage C Keyway cylinder, 0-bitted	No addition
SE	Schlage E Keyway cylinder, 0-bitted	No addition
SG	MicroShield® an antimicrobial powder coat finish	\$88.00

Experience a safer
and more open world

Copyright © 2002-2021 Sargent Manufacturing Company, an ASSA ABLOY Group company. All rights reserved.
Reproduction in whole or in part without the express written permission of Sargent Manufacturing Company is prohibited.
Contact us at: 800-727-5477 or visit www.sargentlock.com. In Canada contact us at: 800-461-3007 or visit www.assaabloydss.ca

ASSA ABLOY

8800/8900 STAND ALONE PRODUCTS

USA & Canada Prices Effective May 1, 2021



ET CONTROL

Standard Lever Designs: A, B, E, F, J, L, P, W

Coastal Lever Designs: G, R, S, Y

Studio Collection Levers Except for Gramercy, Wooster Square, & Grant Park

For Gramercy, Wooster Square, & Grant Park Levers – Add \$160.00 to below prices
Consult catalog for available lever designs, finishes, & ordering information.

KP8800 and KP8900 Keypad Exit Devices			10BE/32D BSP/WSP	03/04/09/10/10B/ 10BL/20D/32
Option	Function	Description		
KP	8877 ET x lever	Keypad Rim Exit Device with cylinder override	\$3,022.00	\$3,075.00
KP	8878 ET x lever	Keypad Rim Exit Device - no cylinder override	\$2,946.00	\$2,999.00
KP	8977 ET x lever	Keypad Mortise Exit Device with cylinder override	\$3,341.00	\$3,394.00
KP	8978 ET x lever	Keypad Mortise Exit Device - no cylinder override	\$3,260.00	\$3,313.00



ET CONTROL

Standard Lever Designs: A, B, E, F, J, L, P, W

Coastal Lever Designs: G, R, S, Y

Studio Collection Levers Except for Gramercy, Wooster Square, & Grant Park

For Gramercy, Wooster Square, & Grant Park Levers – Add \$160.00 to below prices
Consult catalog for available lever designs, finishes, & ordering information.

8800 Profile Series Rim Exit Device			10BE/32D/ BSP/WSP	03/04/09/10/10B/ 10BL/20D/32
Option/Function/Trim		Description		
LK8877 ET x Lever Design		Keypad Rim Exit Device with Cylinder Override (100 Users)	\$2,667.00	\$2,720.00
G1 LU8877 ET x Lever Design		Keypad Rim Exit Device with Cylinder Override (2,000 Users)	\$2,830.00	\$2,883.00
G1 PA8877 ET x Lever Design	*	Proximity ONLY Rim Exit Device with Cylinder Override (2,000 Users)	\$3,335.00	\$3,388.00
G1 PK8877 ET x Lever Design		Proximity and Keypad Rim Exit Device with Cylinder Override (2,000 Users)	\$3,414.00	\$3,467.00
LK8878 ET x Lever Design		Keypad Rim Exit Device without Cylinder override (100 Users)	\$2,600.00	\$2,653.00
G1 LU8878 ET x Lever Design		Keypad Rim Exit Device without Cylinder override (2,000 Users)	\$2,766.00	\$2,819.00
G1 PA8878 ET x Lever Design	*	Proximity ONLY Rim Exit Device without Cylinder Override (2,000 Users)	\$3,271.00	\$3,324.00
G1 PK8878 ET x Lever Design		Proximity and Keypad Rim Exit Device without Cylinder Override (2,000 Users)	\$3,346.00	\$3,399.00

8900 Profile Series Mortise Exit Device				
Option/Function/Trim		Description		
LK8977 ET x Lever Design		Keypad Mortise Exit Device with Cylinder Override (100 Users)	\$2,937.00	\$2,990.00
G1 LU8977 ET x Lever Design		Keypad Mortise Exit Device with Cylinder Override (2,000 Users)	\$3,100.00	\$3,153.00
G1 PA8977 ET x Lever Design	*	Proximity ONLY Mortise Exit Device with Cylinder Override (2,000 Users)	\$3,604.00	\$3,657.00
G1 PK8977 ET x Lever Design		Proximity and Keypad Mortise Exit Device with Cylinder Override (2,000 Users)	\$3,680.00	\$3,733.00
LK8978 ET x Lever Design		Keypad Mortise Exit Device without Cylinder override (100 Users)	\$2,873.00	\$2,926.00
G1 LU8978 ET x Lever Design		Keypad Mortise Exit Device without Cylinder override (2,000 Users)	\$3,034.00	\$3,087.00
G1 PA8978 ET x Lever Design	*	Proximity ONLY Mortise Exit Device without Cylinder Override (2,000 Users)	\$3,539.00	\$3,592.00
G1 PK8978 ET x Lever Design		Proximity and Keypad Mortise Exit Device without Cylinder Override (2,000 Users)	\$3,616.00	\$3,669.00

*Requires SoloPlus for programming.

8800 Profile Series with RF Technology – Rim Exit Device				
Option/Function/Trim		Description		
G1 TU8877 ET x Lever Design		RF Actuation Keypad w/Cylinder Override (2,000 Users)	\$3,072.00	\$3,125.00
G1 TA8877 ET x Lever Design	*	RF Actuation Proximity w/Cylinder Override (2,000 users)	\$3,578.00	\$3,631.00
G1 TP8877 ET x Lever Design		RF Actuation Proximity & Keypad w/Cylinder Override (2,000 users)	\$3,651.00	\$3,704.00
G1 TU8878 ET x Lever Design		RF Actuation Keypad w/o Cylinder Override (2,000 Users)	\$3,009.00	\$3,062.00
G1 TA8878 ET x Lever Design	*	RF Actuation Proximity w/o Cylinder Override (2,000 users)	\$3,512.00	\$3,565.00
G1 TP8878 ET x Lever Design		RF Actuation Proximity & Keypad w/o Cylinder Override (2,000 users)	\$3,588.00	\$3,641.00

8900 Profile Series with RF Technology – Mortise Exit Device				
Option/Function/Trim		Description		
G1 TU8977 ET x Lever Design		RF Actuation Keypad w/Cylinder Override (2,000 Users)	\$3,342.00	\$3,395.00
G1 TA8977 ET x Lever Design	*	RF Actuation Proximity w/Cylinder Override (2,000 users)	\$3,847.00	\$3,900.00
G1 TP8977 ET x Lever Design		RF Actuation Proximity & Keypad w/Cylinder Override (2,000 users)	\$3,923.00	\$3,976.00
G1 TU8978 ET x Lever Design		RF Actuation Keypad w/o Cylinder Override (2,000 Users)	\$3,275.00	\$3,328.00
G1 TA8978 ET x Lever Design	*	RF Actuation Proximity w/o Cylinder Override (2,000 users)	\$3,781.00	\$3,834.00
G1 TP8978 ET x Lever Design		RF Actuation Proximity & Keypad w/o Cylinder Override (2,000 users)	\$3,853.00	\$3,906.00

Note: RF FOB must be ordered separate from Exits – See page PS-10.

*Requires SoloPlus for programming.

PS-10 PROFILE SERIES

SARGENT®

STAND ALONE PRODUCTS ACCESSORIES

ASSA ABLOY

USA & Canada Prices Effective May 1, 2021

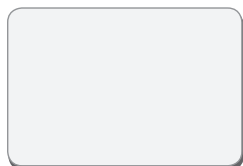

PCH-P30



PF



52-2551

Qty 1 each = 1 card or Fob – must be ordered in multiples of 25.

ISO ProxCard II, ProxKey III, iClass 210		Price
**PCH-P30	HID ISO ProxCard II Blank white card - 26 Bit Format .031 thick - Minimum order 25 each	\$21.00
**PCH-P30-C	HID ISO ProxCard II Blank white card - Custom - customer requested site code, range of card numbers, bit format - Minimum order 25 each	\$21.00
**PCH-C30	HID iCLASS 210 Blank white card - 26 Bit Format .031 thick - Minimum order 25 each	\$11.00
**PCH-C30-C	HID iCLASS 210 Blank white card - Custom - customer requested site code, range of card numbers, bit format - Minimum order 25 each	\$11.00
PF	ProxKey - FOB - Minimum order 25 each	\$16.30
*PF-C	ProxKey III - FOB - Custom - customer requested site code or range of fob numbers - Minimum order 100	\$16.30
52-2551	RF FOB (TU/TP/TA)	\$116.00

Micro Prox Tag for Profile Series Proximity Access Control Products		Price
MPT	MicroProx™ Tag with SARGENT site code - Minimum order 100 each	\$10.24 each
*MPT-C	Custom – Customer requested site code or range of fob numbers - Minimum order 100 each	\$10.24 each

Accessories		Price
ES-G1	Enrollment Station	\$881.00
CDSOLO1	SoloPlus™ Access Control Management Software	\$393.00
DTD	Data Transfer Device (includes SoloPlus Software)	\$955.00

Receive 50% only and \$25.00 list handling charge per item/order.

*Note: - PF-C and MPT-C receive 50% only and \$25.00 list handling charge per item/order.
 - HID technology allows for prox connectivity to access control systems.
 - For a higher level of security, customer cards or fobs w/unique site codes are available - consult factory

**Note: - ISO ProxCard II, ProxKey III iCLASS 210 are trademarks of HID Corporation
 - Cards with unique site codes, specific segment numbering or bit format Consult Factory

STAND ALONE PRODUCTS ACCESSORIES PARTS

USA & Canada Prices Effective May 1, 2021

Additional Accessories		
Part #	Description	Price
3267	Power Supply (9VDC) w/Wall Plug-In Transformer and Box	\$565.00
4293	Wall Prox-Keypad/Card Reader Assy.	\$1,322.00
10-0469	Weatherseal Gasket - 10L	\$19.64
68-1400	Weatherseal Gasket - 88/8900	\$15.81
82-0500	Weatherseal Gasket - 8200	\$26.75
52-0033	Fire Stop	\$24.70
52-0034	Print Paper (6 rolls) for Infrared Portable Printer	\$112.84
52-0069	Battery Cover Only – KP	\$15.00
52-0170	Profile Set Battery Cover without RF Tech.	\$15.00
52-0253	Battery Keeper	\$6.12
52-0254	Weatherseal Gasket	\$7.27
52-0255	Remote Power - Wall Plug-In Transformer - for replacement	\$61.69
52-0256	Remote Power - 12V Gel Cell Battery - Option	\$70.52
52-0258	Remote Power - Cable, Power Supply to Power Transformer - for replacement	\$59.92
52-0344	RF Tech Battery Keeper	\$37.01
52-2071	Remote Unlocking Wire Harness	\$65.24
52-2299	Keypad Only	\$215.63
52-2340	Outside Escutcheon & Keypad	\$470.23
52-2393	Controller Computer Cable Kit - required for SofLink Plus™ w/SofLink PDPTM	\$41.07
52-2400	KP10G77 Controller Replacement Kit	\$415.42
52-2401	KP8200 Controller Replacement Kit	\$415.42
52-2418	24 Conductor Ribbon Cable	\$37.01
52-2431	Proximity Assembly - PA	\$138.63
52-2432	Keypad/Proximity Circuit Brd & Harness Assy (LK) (10L, 8200, 88/8900)	\$219.34
52-2436	Profile Series Battery holder assy.	\$14.89
52-2439	100(LK) User Keypad Controller Assy (10L)	\$448.65
52-2440	100(LK) User Keypad Controller Assy (8200)	\$448.65
52-2441	100(LK) User Keypad Controller Assy (88/8900)	\$448.65
52-2498	Remote Power - 9VDC Power Supply PCB - for replacement	\$437.06
52-2500	Remote Power - Remote Unlocking/Hard Power Harness Connection	\$65.24
52-2509	RF Tech Battery Cover	\$19.41
52-2561	KP88/8900 Controller Replacement Kit	\$415.42
52-2562	Ribbon Cable Assy; 20 Conductor	\$37.01
52-2593	Keypad Shroud Pack	\$71.18
52-2704	Keypad/Proximity Circuit Board & Harness Assy. (G1-LU, G1-PK, G1-TU, G1-TP)	\$523.37
52-2733	2,000 (G1-LU) User Keypad Controller Assy (10L)	\$747.74
52-2734	2,000 (G1-PA, G1-PK) User Keypad Controller Assy. (10L)	\$1,163.12
52-2735	2,000 (G1-TU) User Keypad Controller – 10L	\$996.96
52-2736	2,000 (G1-TA, G1-TP) User Keypad Controller – 10L	\$1,412.34
52-2783	2,000 (G1-LU) User Keypad Controller Assy (8200 & 88/8900)	\$747.74
52-2784	2,000 (G1-PA, G1-PK) User Keypad Controller Assy (8200 & 88/8900)	\$1,163.12
52-2785	2,000 (G1-TU) User Keypad Controller – 8200 & 88/8900	\$996.96
52-2786	2,000 (G1-TA, G1-TP) User Keypad Controller – 8200 & 88/8900	\$1,412.34
52-2847	Conduit (For Weather Protection)	\$14.50
52-3409	Forced/Propped Door Harness	\$25.66

* Specify finish required when ordering.

PS-12 PROFILE SERIES

SARGENT®

ASSA ABLOY

10-LINE STAND ALONE PRODUCTS PARTS

USA & Canada Prices Effective May 1, 2021

Part #	Description	Price
* 547	Retrofit Kit to cover Unican Prep	\$120.00
* 800	Strike (Standard)	Refer to page BL-47
* 808	Strike (28 Option)	Refer to page BL-47
01-0297	1/8" Security Socket Screw Key	\$15.35
01-0803	Battery Alkaline (C-cell)	\$6.15
01-0898	"AA" Batteries	\$2.69
01-1212	Security Screw	\$1.21
10-0019	Cylinder Spacer (Sargent Standard Cylinder & SC, SE Option)	\$0.71
10-0312	Cylinder Retainer (required for lever - standard) - plastic	\$1.66
* 10-0501	Inside Lever "L" Design - Regular	\$76.00
* 10-0502	Outside Lever "L" Design - Sargent Standard Cylinder	\$76.00
* 10-0503	Outside Lever "L" Design - 30 Option	\$76.00
* 10-0523	Inside Lever "B" Design - Regular	\$76.00
* 10-0524	Outside Lever "B" Design - Sargent Standard Cylinder	\$76.00
* 10-0525	Outside Lever "B" Design - 30 Option	\$76.00
* 10-0545	Inside Lever "P" Design - Regular and 30 Option	\$76.00
* 10-0546	Outside Lever "P" Design - Sargent Standard Cylinder	\$76.00
* 10-0547	Outside Lever "P" Design - 30 Option	\$76.00
* 10-0790	Inside and outside Rose Scalp - 26D - G Rose	\$65.76
* 10-0790	Inside and outside Rose Scalp - 3, 4, 9, 10, 10B, 10BL, 20D, 26 - G Rose	\$89.56
* 10-0798	Inside and outside Rose Scalp - 26D - L Rose	\$47.51
* 10-0798	Inside and outside Rose Scalp - 3, 4, 9, 10, 10B, 10BL, 20D, 26 - L Rose	\$71.24
* 10-2052	Screw Pack	\$4.99
* 10-2053	3 3/4" Backset Latch (23 Option)	\$91.12
* 10-2058	5" Backset Latch (25 Option)	\$105.15
* 10-2204	Inside Lever "J" Design - Regular and 30 Option	\$76.00
* 10-2205	Outside Lever "J" Design - Sargent Standard Cylinder	\$76.00
* 10-2206	Outside Lever "J" Design - 30 Option	\$76.00
* 10-2634	3/4" Throw (41 Option) latch	\$139.54
10-2642	77 Lockbody (Std, 10, 21, 23, 30, SC, SE, VA, VS Cylinders)	\$351.06
10-2643	77 Lockbody (60, 63, 64 cylinders)	\$351.06
10-2644	77 Lockbody (70, 72, 65-73, 65-73-7P Options Only)	\$351.06
* 10-2875	Inside Escutcheon Assy - KP	\$711.37
* 10-3015	I/S Esc. Housing Only (Profile Ser.)	\$327.04
* 10-3016	O/S Esc. Housing Only (Profile Ser.)	\$327.04
* 10-3020	I/S Esc. & 100 User Controller - LK	\$742.15
* 10-3026	O/S Esc. - for Keypad, Keypad/Prox (LK)	\$509.68
10-3048	Inside Rose Spring Assy.	\$82.26
10-3049	Outside Rose Spring Assy.	\$83.46
* 10-3126	I/S Esc. & 2,000 User Controller - G1-LU	\$1,019.35
* 10-3127	I/S Esc. & Keypad/Prox or Prox Only Controller - G1-PA, G1-PK	\$1,404.27
* 10-3128	I/S Esc. & 2,000 User Controller - G1-TU	\$1,250.30
* 10-3129	I/S Esc. & Keypad/Prox or Prox Only Controller (G1-TA, G1-TP)	\$1,635.23
* 10-3130	O/S Esc. - For Keypad/Prox (G1-LU, G1-PK, G1-TU, G1-TP)	\$807.24
* 10-3131	O/S Esc. - for Prox. Only (G1-PA, G1-TA)	\$731.39
10-3170	77 Lockbody (SF option)	\$351.06
* 10-3192	2 3/4" Backset Latch (Standard, Guarded)	\$63.11
* 52-2300	Screw Pack	\$32.53

* Specify finish required when ordering.

Experience a safer
and more open world

Copyright © 2002-2021 Sargent Manufacturing Company, an ASSA ABLOY Group company. All rights reserved.
Reproduction in whole or in part without the express written permission of Sargent Manufacturing Company is prohibited.
Contact us at: 800-727-5477 or visit www.sargentlock.com. In Canada contact us at: 800-461-3007 or visit www.assaabloydss.ca

8200 STAND ALONE PRODUCTS TRIM/PARTS

USA & Canada Prices Effective May 1, 2021

8200 - Keypad(KP)		Price
Number	Rose	03/04/09/10/10B/10BE/10BL/14/15/20D/26/26D/BSP/WSP
695LN	LN Rose	refer to ML-113
695L	L Rose	

8200 - Keypad(KP) & Profile Series Inside Levers		Price
Number	Design	03/04/09/10/10B/10BE/10BL/14/15/20D/26/26D/BSP/WSP
81-0467	A-LH	refer to ML-107
81-0468	A-RH	
81-0490	B	
81-0470	E	
81-0471	F	
81-0447	J	
81-0489	L	
81-0513	P	
81-0445	W	

8200 - Keypad & Profile Series Outside Levers		Price
Number	Design	03/04/09/10/10B/10BE/10BL/14/15/20D/26/26D/BSP/WSP
82-0151	A-LH	refer to ML-106
82-0152	A-RH	
82-0153	B	
82-0154	E	
82-0155	F	
82-0156	J	
82-0157	L	
82-0158	P	
82-0159	W	

8200 - Keypad(KP) Outside Lever Trim Set	10BE/26D BSP/WSP	03/04/10/ 14/15/26	09/10B/ 10BL/20D
OS-8276, OS-8277, OS-8278, OS-8279	\$306.00	\$309.00	\$319.00
Standard Roses: LN, L, x Standard Levers: A*, E, F, W Coastal Roses: CR, TR x Coastal Lever Designs: G, R, S, Y Studio Roses: CO, TO, CR, TR, LN, O x Studio Collection Levers Except for Gramercy, Wooster Square, & Grant Park For Gramercy, Wooster Square, & Grant Park- Add \$138.00			
Standard Roses: LN, L x Standard Levers: B, L, P	\$290.00	\$293.00	\$307.00
Standard Roses: LN, L x Standard Lever: J	\$244.00	\$255.00	\$261.00

* Specify finish when ordering

Part #	Description	Price
* 1KB-1	Cylinder Rosette (for Size 41 Cylinder)	\$19.00
* 1KB-3	Cylinder Rosette (for Size 42 Cylinder)	\$19.00
* 90 1/4	Cylinder Ring (for Size 41 Cylinder)	\$8.55
* 90 3/8	Cylinder Ring (for Size 42 Cylinder)	\$8.55
01-0079	Washer	\$0.95
01-0297	1/8" Security Socket Screw Key	\$15.35
01-0543	Spring Grip Fastener (thumbturn)	\$1.81
01-0803	Battery Alkaline ("C" Cell)	\$6.15
01-0844	Washer (thumbturn)	\$0.69
01-0898	Battery Alkaline ("AA" cell)	\$2.69
* 01-1019	Lockbody Screws for Metal #12-24 x 1/2" FL HD	\$0.86
* 01-1028	Outside Front #8-32 x 1/4" FL HD Screw	\$0.85
* 01-1119	#8-32 x 1 1/2" Flat Head Screw	\$1.60
01-1157	#8-32 x 1 1/4" Phillips Pan Head Screw	\$0.34
01-1174	Lever Handle Screw - B, J, L, P, & W Levers	\$3.08
01-1212	Security Screw	\$1.21
01-1472	Lever Handle Screw -A, E, & F Levers	\$3.08
01-1495	#8-32 x 5/8" Machine Screw	\$0.95
01-1500	Fire Stop Screws #8 x 1/2" Type "AB" Ph Pn Hd Self Tap	\$0.38
01-2299	Lockbody Screws for Wood #12 x 1 1/4" FL HD	\$0.48
* 01-4388	#8-1" Phillips Flat Head Screw	\$1.12
13-0140	Compression Spring	\$2.26
52-0159	Cover Plate for ILCO Prep	\$101.96
52-2057	Screw Pack	\$49.81
52-3412	Harness (mates to Dorm Room Controller)	\$34.57
52-3413	Dorm Room Mortise Controller Assembly (PA/PK)	\$1,173.88

* Specify finish required when ordering.

PS-14 PROFILE SERIES

SARGENT®

8200 STAND ALONE PRODUCTS TRIM/PARTS

ASSA ABLOY

USA & Canada Prices Effective May 1, 2021

Part #	Description	Price
77-0168	Thrubolts #8-32 x 1 7/8" Flat Head Screw	\$1.74
77-0772	Spindle (thumbturn)	\$8.41
*77-4236	Screw Pack	\$6.07
81-0723	Post	\$2.10
*82-0081	Outside Front - 78 & 79 functions	\$53.36
*82-0084	Outside Front - 76 & 77 functions	\$53.36
82-0184	Cap Nut	\$7.86
82-0347	I/S Spring / O/S Spring (part # for 1 spring)	\$0.95
82-0368	I/S Spindle / O/S Spindle (part # for 1 spindle)	\$10.30
*82-0492	I/S Esc. Housing Only without Thumbturn	\$360.41
*82-0493	O/S Esc. Housing Only without cylinder hole	\$360.41
*82-0494	I/S Esc. Housing Only w/Thumbturn	\$360.41
*82-0495	O/S Esc. Housing Only with cylinder hole	\$360.41
82-0507	Thumbturn	\$33.96
82-3082	Plate Assy	\$10.30
82-3088	Inside Adapter & Plate Assy	\$28.09
*82-3729	Inside Escutcheon & Plug Assy (KP8278/KP8279)	\$743.75
*82-3730	Inside Escutcheon & Turn Lever Assy (KP8276/KP8277)	\$743.75
*82-3837	I/S Esc. with Thumbturn and 100 user Controller (LK)	\$770.92
*82-3838	I/S Esc. without Thumbturn and 100 user Controller (LK)	\$770.92
*82-3846	O/S Esc. with Cyl. Hole & Keypad (LK)	\$529.42
*82-3847	O/S Esc. without Cyl. Hole & Keypad (LK)	\$529.42
*82-4182	I/S Esc. with Thumbturn and 2,000 user Controller (G1-LU)	\$1,058.83
*82-4183	I/S Esc. without Thumbturn and 2,000 user Controller (G1-LU)	\$1,058.83
*82-4184	I/S Esc. with Thumbturn Prox/Keypad Controller (G1-PA, G1-PK)	\$1,458.64
*82-4185	I/S Esc. without Thumbturn Prox/Keypad Controller (G1-PA, G1-PK)	\$1,458.64
*82-4186	I/S Esc. with Thumbturn & 2,000 User Controller (G1-TU)	\$1,298.72
*82-4187	I/S Esc. without Thumbturn & 2,000 User Controller (G1-TU)	\$1,298.72
*82-4188	I/S Esc. with Thumbturn & Keypad/Prox or Prox Only Controller (G1-TA, G1-TP)	\$1,698.57
*82-4189	I/S Esc. without Thumbturn & Keypad/Prox or Prox Only Controller (G1-TA, G1-TP)	\$1,698.57
*82-4190	O/S with Cyl. Hole Keypad/Prox (G1-LU, G1-PK, G1-TU, G1-TP)	\$842.87
*82-4191	O/S without Cyl. Hole Keypad/Prox (G1-LU, G1-PK, G1-TU, G1-TP)	\$914.89
*82-4192	O/S Esc. with Cyl. Hole & Prox Only (G1-PA, G1-TA)	\$759.72
*82-4193	O/S Esc. without Cyl. Hole & Prox Only (G1-PA, G1-TA)	\$759.72

* Specify finish required when ordering.

8800/8900 STAND ALONE PRODUCTS TRIM/PARTS

USA & Canada Prices Effective May 1, 2021

88/89 - Keypad(KP) & Profile Series ET Trim Set			03/04/09/10/10B/10BE/10BL/ 14/15/20D/26/26D/BSP/WSP	
Number	Exit Function	Description		
777 ET x Lever Design	8977	Standard Lever Designs: A, B, E, F, J, L, P, W		
778 ET x Lever Design	8978	Coastal Lever Designs: C, G, R, S, Y		\$1,329.00
777-8 ET x Lever Design	8877	Studio Collection Levers Except for Gramercy, Wooster Square, & Grant Park		
778-8 ET x Lever Design	8878	For Gramercy, Wooster Square, & Grant Park – Add \$160.00		
Consult catalog for available lever designs, finishes, & ordering information				
8900 - Keypad(KP) & Profile Series Mortise Lockbodies			03/04/09/10/10B/10BE/10BL/ 14/15/20D/26/26D/BSP/WSP	
Number	Exit Function			
977	8977			\$749.00
978	8978			
88/89 - Keypad Upgrade Kits to Convert to Profile Series			10BE/26D/ BSP/WSP	03/04/09/10/10B/ 10BL/14/15/20D/26
Number	Kit Type	Description		
231LK	1-Pack	Keypad w/Cyl. Override (100 users)	\$780.00	\$840.00
231G1LU	1-Pack	Keypad w/Cyl. Override (2,000 users)	\$1,084.00	\$1,131.00
231G1PA	1-Pack	Prox Only w/Cyl. Override (2,000 Users)	\$1,503.00	\$1,551.00
231G1PK	1-Pack	Keypad & Prox w/Cyl. Override (2,000 Users)	\$1,560.00	\$1,609.00
88/89 - Keypad Upgrade Kits to Convert to Profile Series			10BE/26D/ BSP/WSP	03/04/09/10/10B/ 10BL/14/15/20D/26
Number	Kit Type	Description		
233LK	3-Pack	Keypad w/Cyl. Override (100 users)	\$2,093.00	\$2,270.00
233G1LU	3-Pack	Keypad w/Cyl. Override (2,000 users)	\$3,034.00	\$3,187.00
233G1PA	3-Pack	Prox Only w/Cyl. Override (2,000 Users)	\$4,292.00	\$4,442.00
233G1PK	3-Pack	Keypad & Prox w/Cyl. Override (2,000 Users)	\$4,467.00	\$4,616.00
88/89 - Keypad Upgrade Kits to Convert to Profile Series			10BE/26D/ BSP/WSP	03/04/09/10/10B/ 10BL/14/15/20D/26
Number	Kit Type	Description		
231G1TU	1-Pack	Keypad w/Cyl. Override (2,000 users)	\$1,388.00	\$1,433.00
231G1TA	1-Pack	Prox Only w/Cyl. Override (2,000 users)	\$1,783.00	\$1,830.00
231G1TP	1-Pack	Keypad & Prox w/Cyl. Override (2,000 Users)	\$1,837.00	\$1,885.00
88/89 - Keypad Upgrade Kits to Convert to Profile Series			10BE/26D/ BSP/WSP	03/04/09/10/10B/ 10BL/14/15/20D/26
Number	Kit Type	Description		
233G1TU	3-Pack	Keypad w/Cyl. Override (2,000 users)	\$3,960.00	\$4,103.00
233G1TA	3-Pack	Prox Only w/Cyl. Override (2,000 users)	\$5,141.00	\$5,283.00
233G1TP	3-Pack	Keypad & Prox w/Cyl. Override (2,000 Users)	\$5,304.00	\$5,444.00

PS-16 PROFILE SERIES

SARGENT®

8800/8900 STAND ALONE PRODUCTS TRIM/PARTS

ASSA ABLOY

USA & Canada Prices Effective May 1, 2021

Part #	Description	Price
649	12-8800 Strike	\$90.10
908	8900 Strike	\$36.50
C908	12-8900 Strike – Specify hand when ordering	\$38.31
01-0297	1/8" Security Socket Screw Key	\$15.35
01-0898	Battery Alkaline ("AA" Cell)	\$2.69
*01-1119	#8-32 x 1-1/2" Flat Head Machine Screw	\$1.60
01-1212	Security Screws	\$1.21
01-1500	Fire Stop Screws #8 x 1/2" Type "AB" PH Pn Hd Self Tap	\$0.38
01-4451	Chassis Thru Bolts - 1/4-20 x 2-3/8" Flat Head Machine Screws	\$1.86
13-0074	#12-24 x 2-1/8" Flat Head Machine Screw	\$0.73
52-0086	Inside Mounting Bracket	\$3.54
*52-0087	KP-88/8900 I/S Esc	\$215.21
52-0175	Inside Escutcheon End Cap	\$3.81
52-0176	Outside Escutcheon End Cap	\$3.81
52-0263	ET Trim Weather Seal Gasket	\$12.10
52-2022	Tool Pack for 8977	\$53.72
52-2211	Tool Pack for 8978	\$53.72
*52-2302	Inside Escutcheon/Controller Assy – KP	\$735.84
52-2303	Screw Pack	\$44.01
52-2425	Screw Pack	\$27.67
52-2460	Inside Escutcheon Assy. & 100 User Controller (LK)	\$762.75
52-2474	Outside Escutcheon Assy. (Keypad -LK)	\$523.81
*52-2833	Inside Escutcheon Assy. & 2,000 User Controller (G1-LU)	\$1,047.60
*52-2834	Inside Escutcheon Assy. & 2,000 User Controller (G1-PA, G1-PK)	\$1,443.21
*52-2835	Inside Escutcheon Assy. & Keypad/Prox or Prox Only 2,000 User Controller (G1-TA, G1-TP)	\$1,680.56
*52-2836	Inside Escutcheon Assy. & 2,000 User Controller (G1-TU)	\$1,284.96
*52-2838	Outside Escutcheon Assy. (Keypad/Prox –G1-LU, G1-PK, G1-TU, G1-TP)	\$833.93
*52-2839	Outside Escutcheon Assy. (Keypad – Prox Only – G1-PA, G1-TA)	\$751.67
52-5654	EcoFlex ET Harness KP, G1.5, LK	\$15.04
*68-0406	8800 Chassis Cover	\$243.82
*68-0407	8900 Chassis Cover	\$243.82
68-1396	Inside Escutcheon Housing ONLY	\$372.70
68-1397	Outside Escutcheon Housing ONLY	\$344.65
68-2172	Chassis Assy LHRB (12-) 8900	\$582.64
68-2173	Chassis Assy RHRB (12-) 8900	\$582.64
68-4261	Chassis Assy LHRB/RHRB – 8800	\$493.01
68-4263	Chassis Assy LHRB/RHRB – 12-8800	\$503.37
77-0685	Escutcheon Thru Bolts	\$7.28

* Specify finish required when ordering.

Experience a safer
and more open world

Copyright © 2002-2021 Sargent Manufacturing Company, an ASSA ABLOY Group company. All rights reserved.
Reproduction in whole or in part without the express written permission of Sargent Manufacturing Company is prohibited.
Contact us at: 800-727-5477 or visit www.sargentlock.com. In Canada contact us at: 800-461-3007 or visit www.assaabloydss.ca



Copyright © 2002-2021 Sargent Manufacturing Company, an ASSA ABLOY Group company.
All rights reserved. Reproduction in whole or in part without the express written permission
of Sargent Manufacturing Company is prohibited.

**For USA Contact us at: 800-727-5477
or visit www.sargentlock.com**

**For Canada contact us at: 800-461-3007
or visit www.assaabloydss.ca**